



For details about certified products conforming to international standards, visit us at www.smcworld.com.

5 Port Direct Operated Poppet Solenoid Valve, Rubber Seal

Series VK3000

C: 0.54 dm³/(s·bar)
(Passage {4/2 → 5/3 (A/B → R1/R2)})

**Compact: Width 18 x
Length 68 (mm)**

Low power consumption

4 W DC (Standard type)
2 W DC (Low wattage type)

Suitable for copper-free applications

All the parts in contact with fluid are non-copper materials

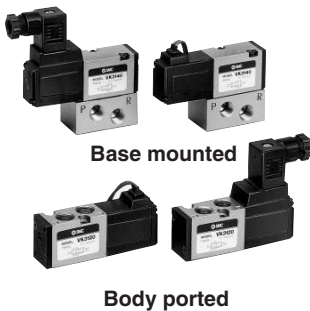

Base mounted

Body ported

JIS Symbol

Body ported

Base mounted

Mounting with VK300



Series VK300 can be mounted on the same manifold base VV5K3 of VK3000 series. For details, refer to the page 3-2-4.

Used as a 3 Port Valve

Series VK3000 can be used as 3 port valve, as a N.C. or N.O. type, by plugging either "A" or "B" cylinder Port. Make sure not to plug the exhaust port "R".

Plug position	B port	A port
Type of actuation	N. C.	N. O.
JIS symbol		

Specifications

Type of actuation	Direct operated type 2 position single solenoid
Fluid	Air
Ambient and fluid temperature	-10 to 50°C (No freezing. Refer to page 3-13-4.)
Response time (at the pressure of 0.5 MPa) ⁽¹⁾	10 ms or less (Standard), 15 ms or less (Low wattage type)
Manual override	Non-locking push type
Lubrication	Not required (Use turbine oil Class 1 ISO VG32, if lubricated.)
Mounting orientation	Unrestricted
Impact/Vibration resistance ⁽²⁾	300/50 m/s ²
Enclosure	Dustproof



Note 1) Based on dynamic performance test, JIS B 8375-1981. (Coil temperature: 20°C, at rated voltage, without surge suppressor)

Note 2) Impact resistance: No malfunction occurred when it is tested with a drop tester in the axial direction and at the right angles to the main valve and armature in both energized and de-energized states every once for each condition. (Values at the initial period)

Vibration resistance: No malfunction occurred in a one-sweep test between 45 and 2000 Hz. Test was performed at both energized states in the axial direction and at the right angles to the main valve and armature. (Values at the initial period)

Solenoid Specifications

Electrical entry	Grommet (G), DIN terminal (D)	
Rated voltage (V)	AC	100, 110, 200, 220, 240
	DC	6, 12, 24, 48
Allowable voltage fluctuation	±10% of rated voltage	
Apparent power (AC)*	Inrush	9.5 VA/50 Hz, 8 VA/60 Hz
	Holding	7 VA/50 Hz, 5 VA/60 Hz
Power consumption (DC)*	W/o indicator light	4 W (Standard), 2 W (Low wattage)
	W/ indicator light	4.3 W (Standard), 2.3 W (Low wattage)
Surge voltage suppressor	AC	Varistor
	DC	Diode (12 VDC or less: Varistor)
Indicator light	AC	Neon bulb
	DC	LED



* At the rated voltage

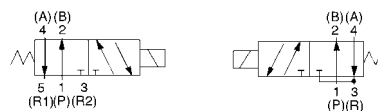

Flow Characteristics/Weight

Valve model	Operating pressure range (MPa)	Port size	Flow characteristics						Weight (g)
			1 → 4/2 (P → A/B)		4/2 → 5/3 (A/B → R1/R2)		Grommet		
			C [dm ³ /(s·bar)]	b	Cv	C [dm ³ /(s·bar)]		b	Cv
Body ported	0 to 0.7	M5 x 0.8	0.45	0.37	0.12	0.43	0.37	0.12	90
			1/8	0.84	0.10	0.19	0.40	0.33	
1/8		0.38	0.30	0.09	0.40	0.34	0.10		
		0.48	0.11	0.11	0.35	0.38	0.10		
Base mounted (with sub-plate)	1/8	0.63	0.10	0.14	0.54	0.12	0.12	130	
		0.50	0.12	0.11	0.48	0.19	0.12		

How to Order

Electrical entry

G: Grommet (Lead wire length: 300 mm)	H: Grommet (Lead wire length: 600 mm)	D: DIN terminal	DO: DIN terminal (Without connector)
---	---	---------------------------	---



* For connector part number, refer to page 3-2-11.

Rated voltage

1	100 VAC, 50/60 Hz
2	200 VAC, 50/60 Hz
3*	110 VAC, 50/60 Hz
4*	220 VAC, 50/60 Hz
5	24 VDC
6*	12 VDC
7*	240 VAC, 50/60 Hz
9	Other

* Option



Port size (P, A and B port)

M5	M5 x 0.8
01	Rc 1/8

* R1, R2: M5

Option

Nil	None
F	With bracket (Not assembled)

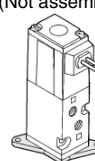

Option Part No.

Description	Part no.	Note
Bracket	VK300-43-2A	With screw

Body ported

VK3120 [] **1** **G** [] **M5** []

Base mounted

VK3140 [] **1** **G** [] **01** []

Thread type

Nil	Rc
F	G
N	NPT
T	NPTF

Valve option

Nil	Standard
Y *	For low wattage (2 W DC)

* Option



Port size

01	Rc 1/8 (With sub-plate)
Nil	Without sub-plate

Light/Surge voltage suppressor

Nil	None
S	With surge voltage suppressor
Z	With light/surge voltage suppressor (Type D only)



* Since the indicator light is built in the connector, thus, "DOZ" is not available.

Construction

JIS Symbol

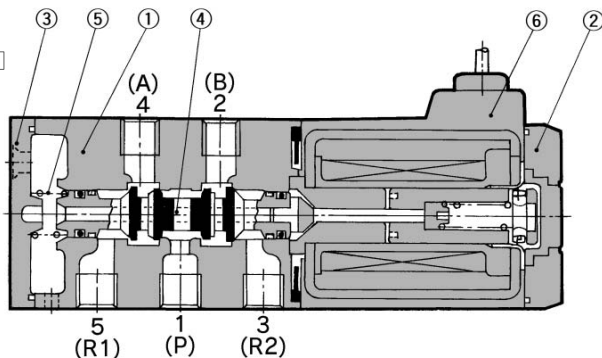
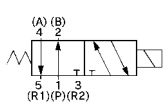

Component Parts

No.	Description	Material	Note
①	Body	Aluminum die-casted	Platinum silver
②	Cover	Resin	Black
③	End cover	Resin	Black
④	Spool valve assembly	Aluminum, NBR	
⑤	Return spring	Stainless steel	
⑥	Molded coil	Resin	Black

Series VK3000 Manifold Specifications

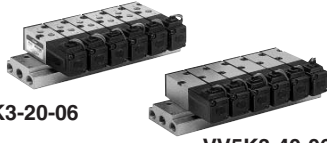

VV5K3-20-06

VV5K3-40-06-M5

Specifications

Valve stations		1 to 20
Piping method	Common SUP, Common EXH	Body ported, Base mounted
	Common SUP, Individual EXH	Body ported

Common SUP/Common EXH

Type 20: Body ported (A, B port top ported)

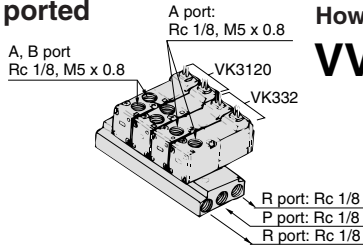

How to Order

VV5K3-20-05-□

Valve stations	
01	1 station
⋮	⋮
20	20 stations

Thread type

Nil	Rc
00F	G
00N	NPT
00T	NPTF

Applicable solenoid valve
VK3120□-□□□-M5
VK3120□-□□□-01
VK332□-□□□-M5
VK332□-□□□-01

Applicable blanking
plate assembly
VK3000-7-1A

Type 40: Base mounted (A, B port bottom ported)

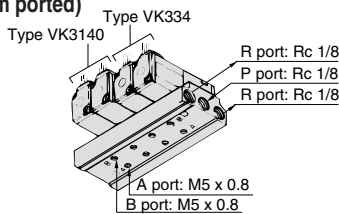

How to Order

VV5K3-40-05-M5-□

Valve stations	
01	1 station
⋮	⋮
20	20 stations

Thread type

Nil	Rc
F	G
N	NPT
T	NPTF

Applicable solenoid valve
VK3140□-□□□
VK334□-□□□

Applicable blanking
plate assembly
VK3000-7-1A

Type 41: Base mounted (A, B port side ported)

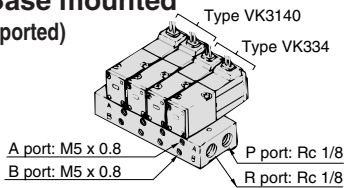

How to Order

VV5K3-□-41-05-M5-□

Solenoid direction

Nil	Solenoid on same side of A and B port
S	Solenoid on same side of A and B port

Valve stations

01	1 station
⋮	⋮
20	20 stations

Port size

M5	M5 x 0.8
C4	ø4 cassette

Thread type

Nil	Rc
F	G
N	NPT
T	NPTF

Applicable solenoid valve
VK3140□-□□□
VK334□-□□□

Applicable blanking
plate assembly
VK3000-7-1A

Type S41

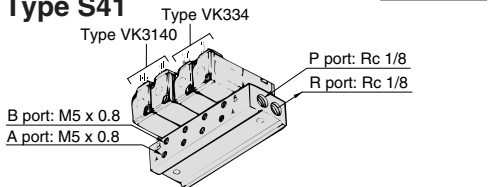

Type 42: Base mounted (A, B port side ported)

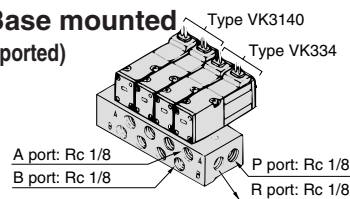

How to Order

VV5K3-□-42-05-01-□

Solenoid direction

Nil	Solenoid on same side of A and B port
S	Solenoid on same side of A and B port

Valve stations

01	1 station
⋮	⋮
20	20 stations

Port size

01	Rc 1/8
C6	ø6 cassette

Thread type

Nil	Rc
F	G
N	NPT
T	NPTF

Applicable solenoid valve
VK3140□-□□□
VK334□-□□□

Applicable blanking
plate assembly
VK3000-7-1A

Type S42

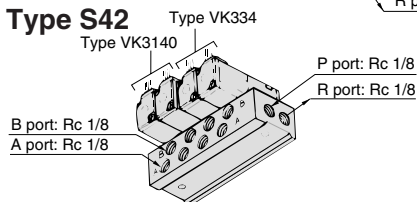

Common SUP/Individual EXH

Type 21: Body ported (A, B port top ported)

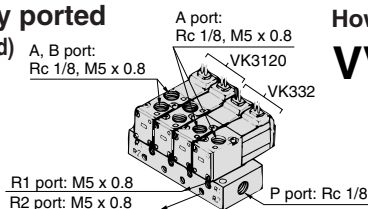

How to Order

VV5K3-21-05-□

Valve stations	
01	1 station
⋮	⋮
20	20 stations

Thread type

Nil	Rc
F	G
N	NPT
T	NPTF

Applicable solenoid valve
VK3120□-□□□-M5
VK3120□-□□□-01
VK332□-□□□-M5
VK332□-□□□-01

Applicable blanking
plate assembly
VK3000-7-1A

Series VK3000

Combinations of Solenoid Valve, Manifold Gasket and Manifold Base

5 port body ported: VK3120

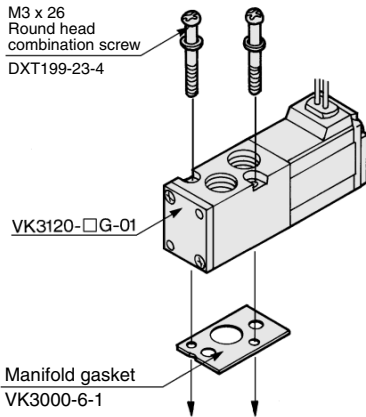

Applicable base
Type VV5K3-20 } Manifold base
Type VV5K3-21 }

5 port base mounted: VK3140

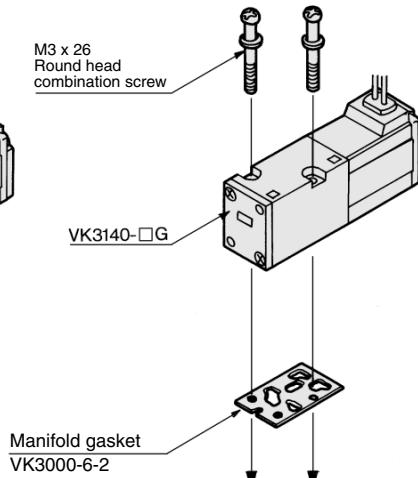

Applicable base
VK3000-9-1 Sub-plate } Manifold base
Type VV5K3-40 }
Type VV5K3-(S)41 }
Type VV5K3-(S)42 }

	Body ported	Base mounted
Manifold gasket	VK3000-6-1A	VK3000-6-2A
Screw assembly		

Caution Mounting Screw Tightening Torques
M3: 0.6 N·m

Combination of Blanking Plate Assembly and Manifold Base

Blanking plate assembly: VK3000-7-1A

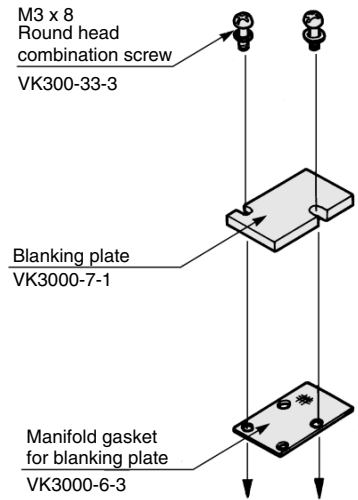

Applicable base: In common for all types of VV5K3 models

Caution Mounting Screw Tightening Torques
M3: 0.6 N·m

Note) Mounting direction is not flexible. Make sure to mount them in the right direction.

Mixed Mounting of VK300 and Manifold Base of Series VK3000

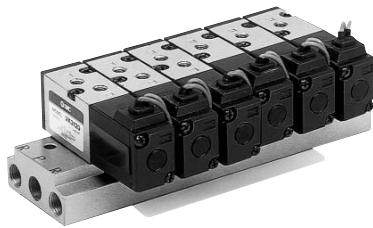

1. In the case of VV5K3-20/40

When installing the 3 port valve on the manifold base, plug the "R" port at the corresponding mark side with the rubber plug (VK3000-8-1) as shown in the figures on the right.

2. Other manifold

3 port valve except VV5K3-20 and 40 types can be mounted without any work.

Note 1) Remove the plug if changing the 3 port valve to a 5 port valve.

Note 2) In case a 3 port valve VK300 is mounted on the manifold base for a 5 port valve VK3000, switching type is normally closed (N.C.). If requiring a normally open type (N.O.), plug the "A" port on the 5 port valve.

Note 3) "A" port of a 3 port valve for base mounted type becomes "A" port of a 5 port valve. Plug that "A" port to avoid mistaking "B" port for the "A" port.

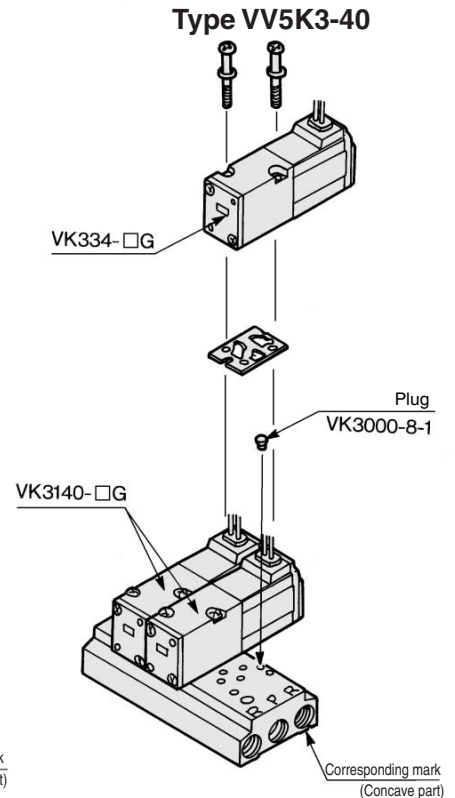
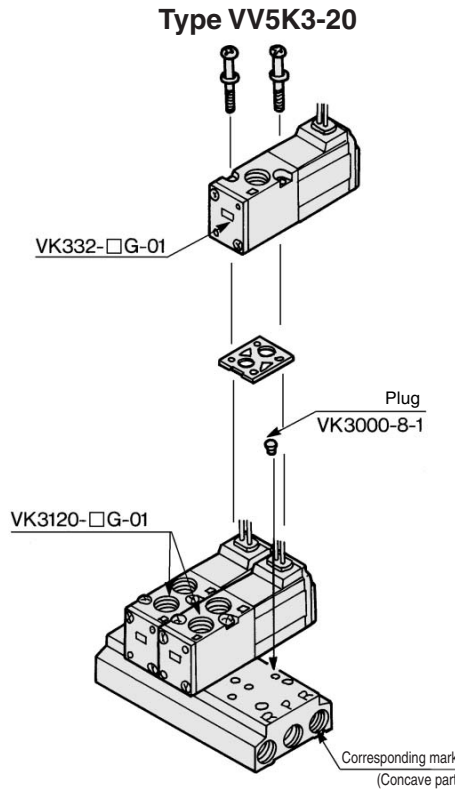

Caution Mounting Screw Tightening Torques
M3: 0.6 N·m

5 Port Direct Operated Poppet Solenoid Valve Rubber Seal Series VK3000

Dimensions: Body Ported

Grommet: VK3120-□G-M5
Port size: M5

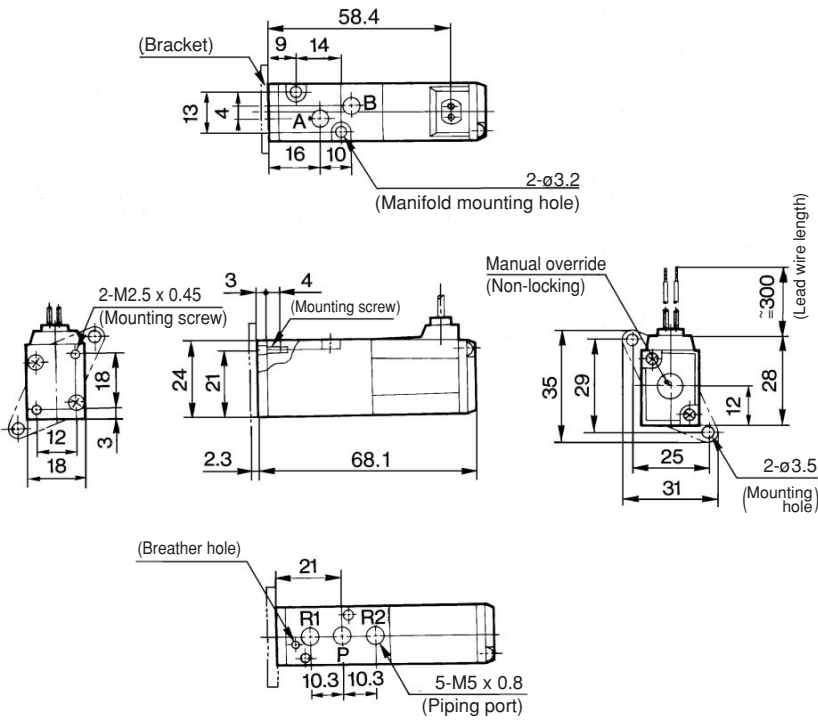

DIN terminal: VK3120-□D-M5

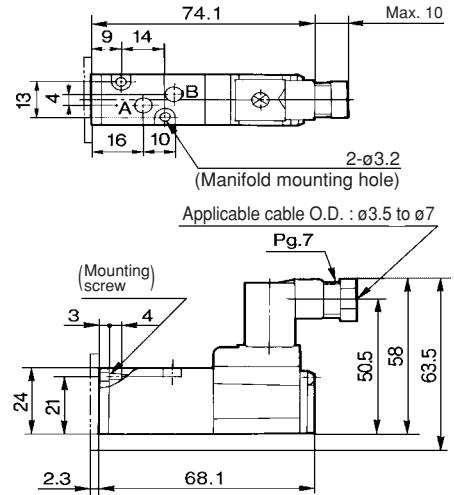

Refer to grommet type for other dimensions.

- VK
- VZ
- VF
- VFR
- VP4
- VZS
- VFS
- VS4
- VQ7
- EVS
- VFN

Grommet: VK3120-□G-01
Port size: Rc 1/8

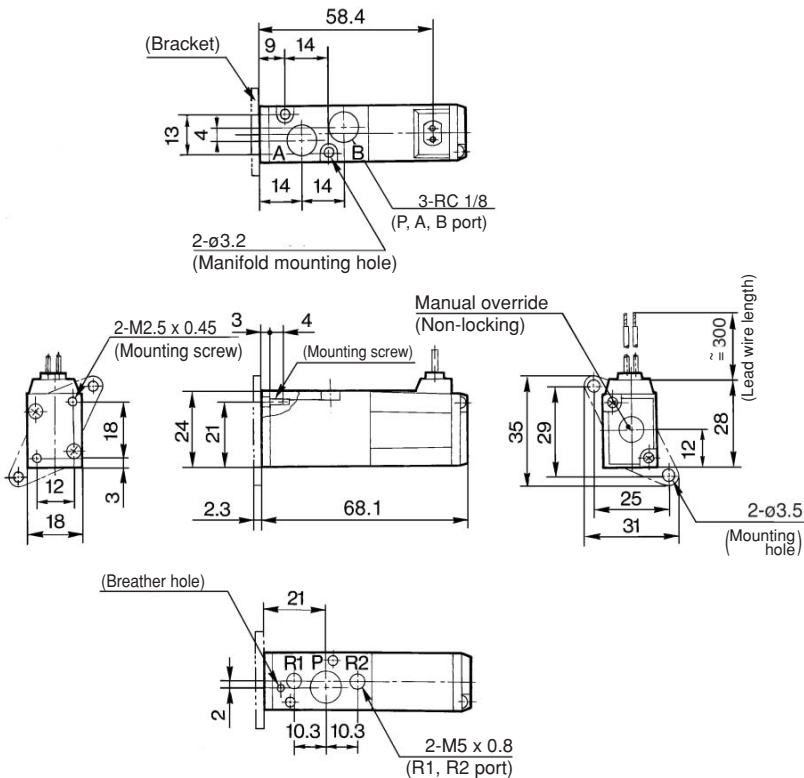

DIN terminal: VK3120-□D-01

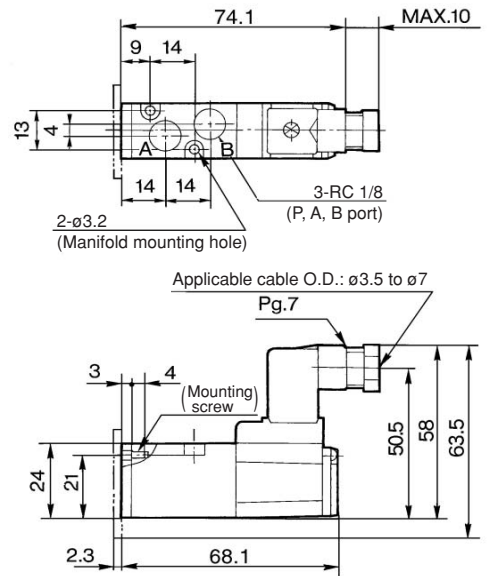

Refer to grommet type for other dimensions.

Series VK3000

Dimensions: Base Mounted

Grommet: VK3140-□G-01

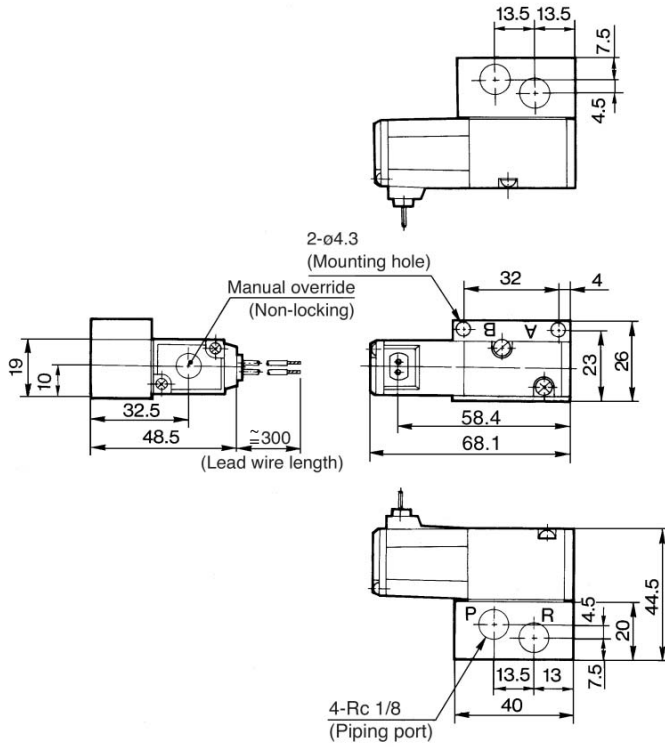

DIN terminal: VK3140-□D-01

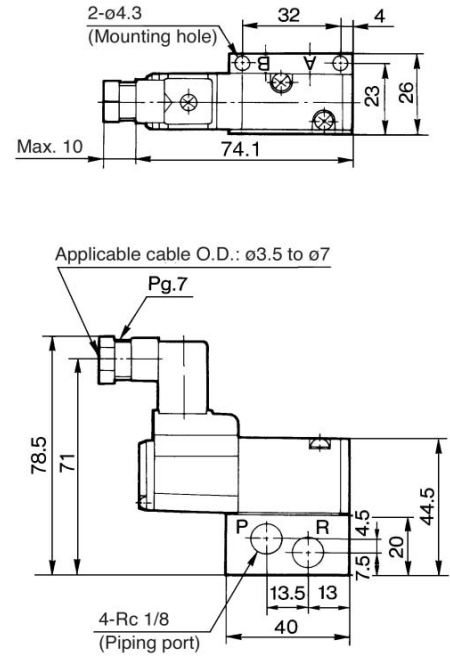

Refer to grommet type for other dimensions.

5 Port Direct Operated Poppet Solenoid Valve Rubber Seal Series VK3000

Type 20 Manifold Body ported (Top ported)

VV5K3-20- Station

n1 = Number of VK3000
n2 = Number of VK300

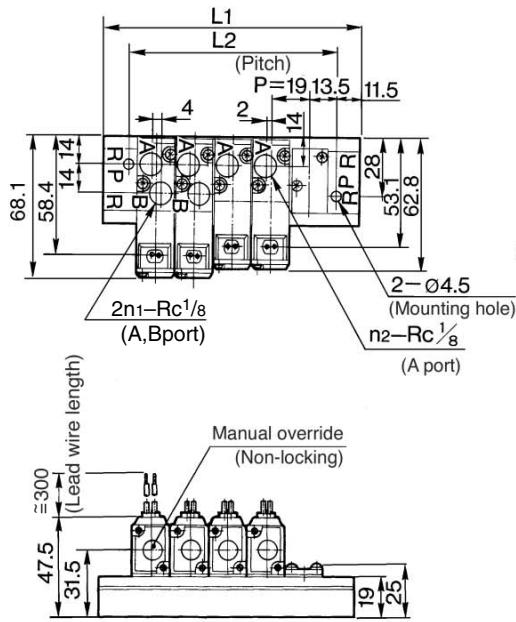

Grommet: G

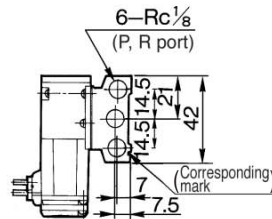

DIN terminal: D

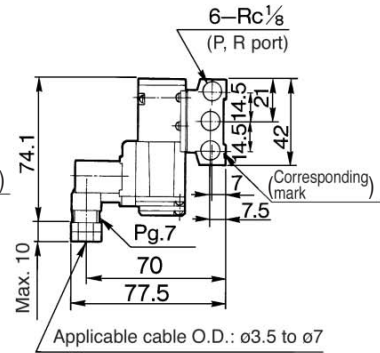

L Dimension

n: Stations

L \ n	1	2	3	4	5	6	7	8	9	10	11	12	13	14	15	16	17	18	19	20
L ₁	50	69	88	107	126	145	164	183	202	221	240	259	278	297	316	335	354	373	392	411
L ₂	27	46	65	84	103	122	141	160	179	198	217	236	255	274	293	312	331	350	369	388

- VK
- VZ
- VF
- VFR
- VP4
- VZS
- VFS
- VS4
- VQ7
- EVS
- VFN

Type 21 Manifold Body ported (Top ported)

VV5K3-21- Station

Grommet: G

DIN terminal: D

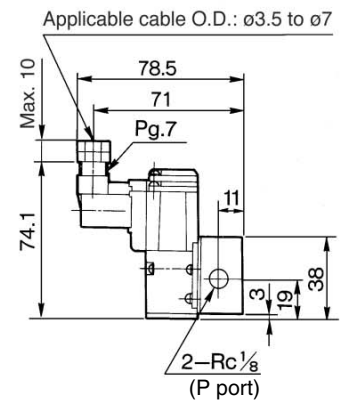
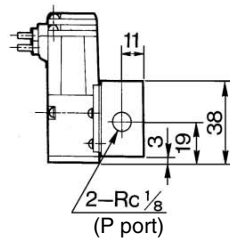
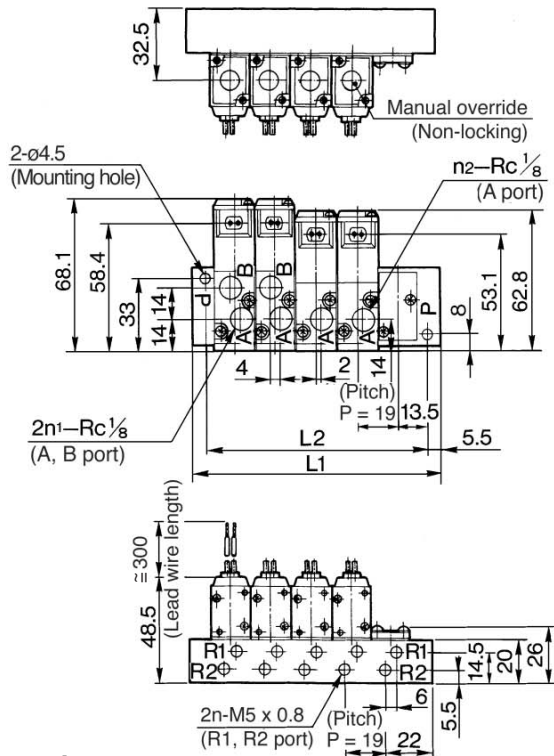

n1 = Number of VK3000
n2 = Number of VK300

L Dimension

n: Stations

L \ n	1	2	3	4	5	6	7	8	9	10	11	12	13	14	15	16	17	18	19	20
L ₁	38	57	76	95	114	133	152	171	190	209	228	247	266	285	304	323	342	361	380	399
L ₂	27	46	65	84	103	122	141	160	179	198	217	236	255	274	293	312	331	350	369	388

Series VK3000

Type 40 Manifold Base mounted (Bottom ported)

VV5K3-40-Station-M5

Grommet: G

DIN terminal: D

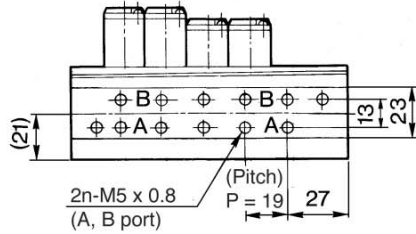
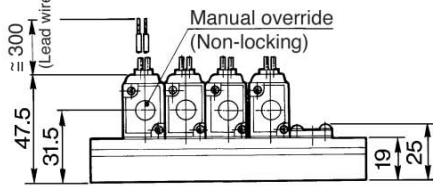
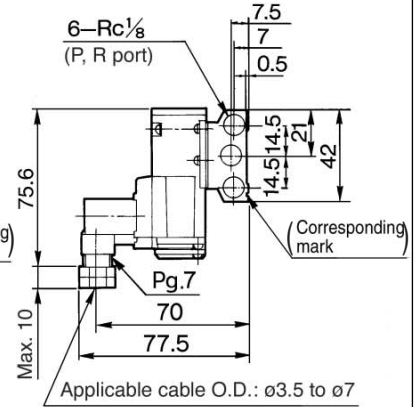
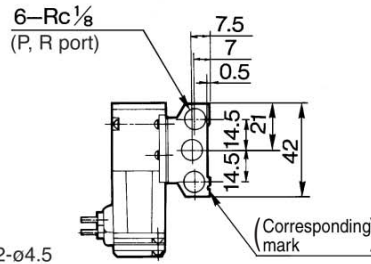
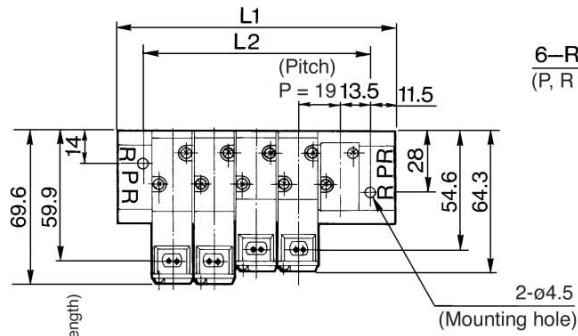

L Dimension

n: Stations

L \ n	1	2	3	4	5	6	7	8	9	10	11	12	13	14	15	16	17	18	19	20
L ₁	50	69	88	107	126	145	164	183	202	221	240	259	278	297	316	335	354	373	392	411
L ₂	27	46	65	84	103	122	141	160	179	198	217	236	255	274	293	312	331	350	369	388

5 Port Direct Operated Poppet Solenoid Valve Rubber Seal Series **VK3000**

Type 41 Manifold Base mounted (Side ported)

VV5K3-41-Station-M5

Grommet: G

DIN terminal: D

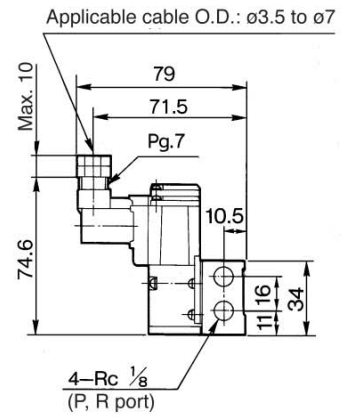
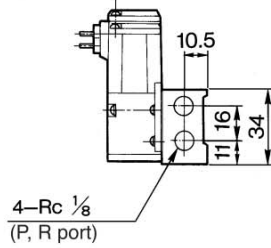
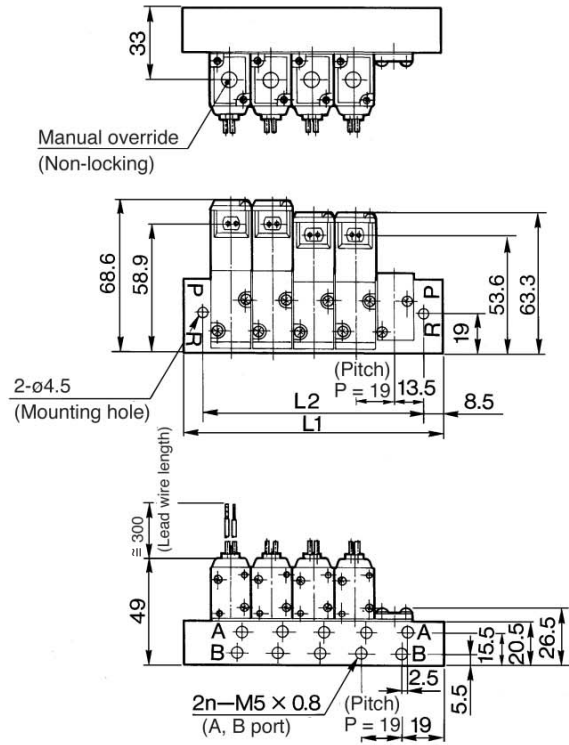

Built-in One-touch fitting: VV5K3-41-Station-C4

Solenoid is at the same side as A port: VV5K3-S41-Station-□

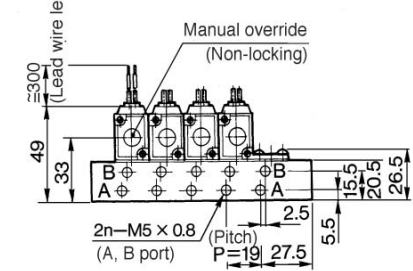
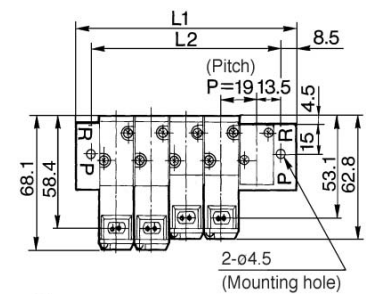
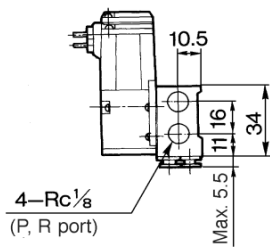
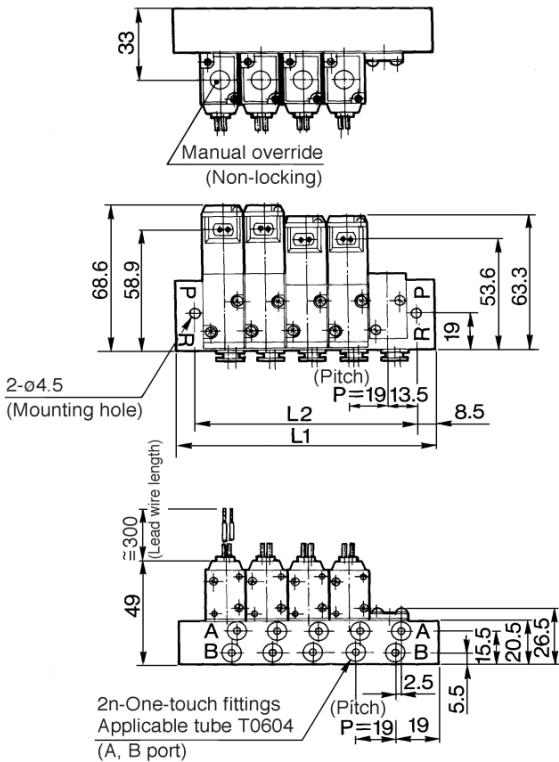

Refer to the above drawing for DIN terminal dimensions.

Refer to the above drawing for other dimensions.

L	n	1	2	3	4	5	6	7	8	9	10	11	12	13	14	15	16	17	18	19	20
L_1		44	63	82	101	120	139	158	177	196	215	234	253	272	291	310	329	348	367	386	405
L_2		27	46	65	84	103	122	141	160	179	198	217	236	255	274	293	312	331	350	369	388

- VK**
- VZ
- VF
- VFR
- VP4
- VZS
- VFS
- VS4
- VQ7
- EVS
- VFN

Series VK3000

Type 42 Manifold Base mounted (Side ported)

VV5K3-42-Station-01

Grommet: G

DIN terminal: D

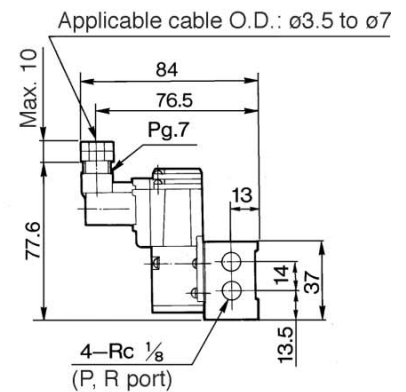
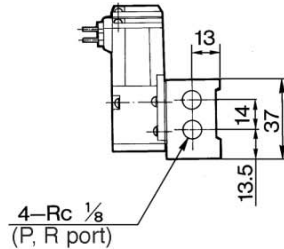
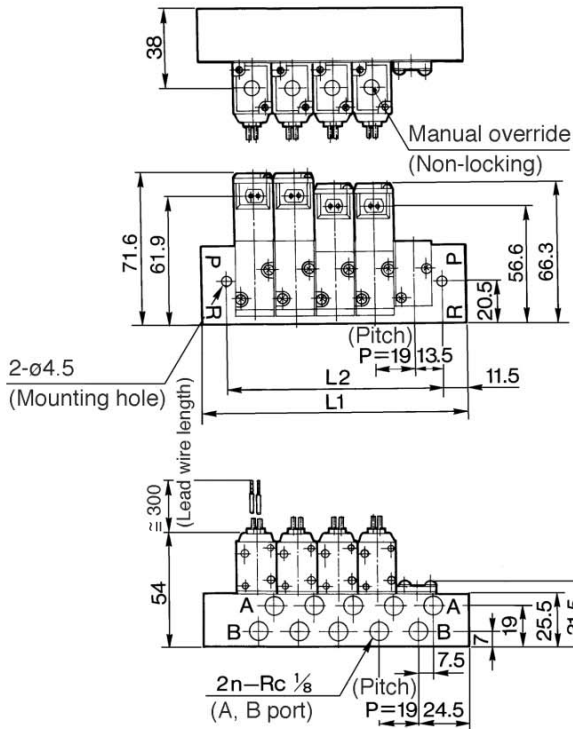

Built-in One-touch fitting: VV5K3-42-Station-C6

Solenoid is at the same side as A port: VV5K3-S42-Station-□

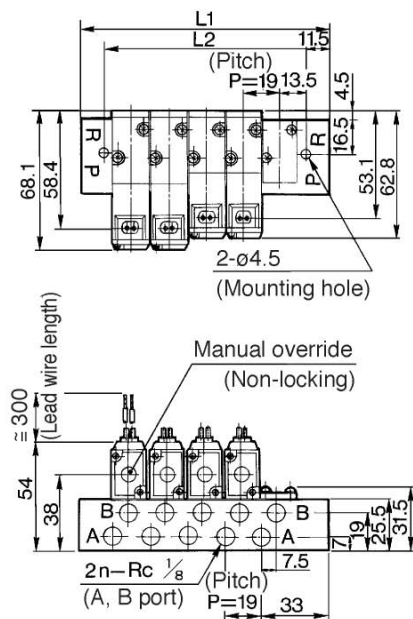
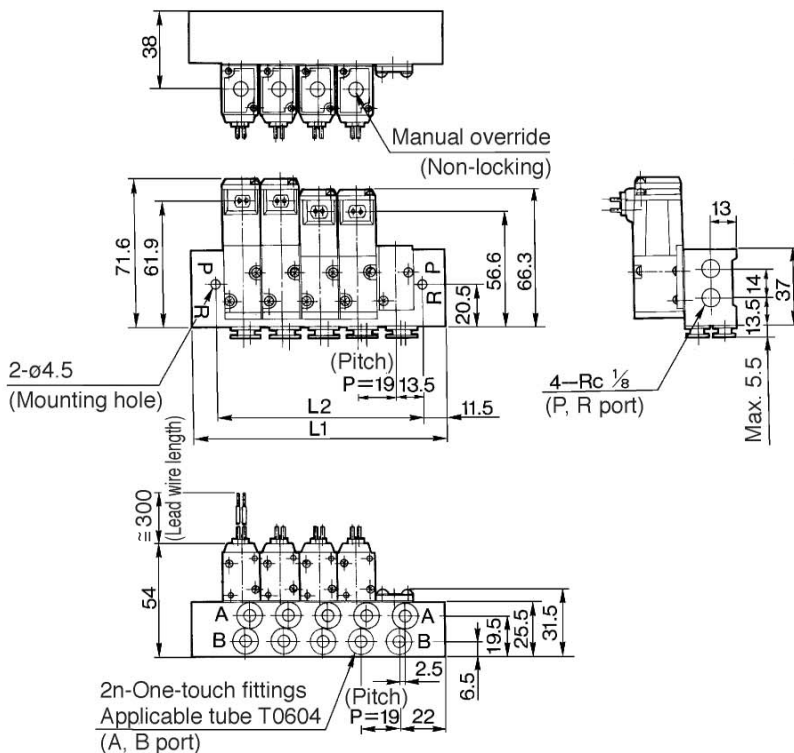

Refer to the above drawing for DIN terminal dimensions.



Refer to the above drawing for other dimensions.

L \ n	1	2	3	4	5	6	7	8	9	10	11	12	13	14	15	16	17	18	19	20
L ₁	50	69	88	107	126	145	164	183	202	221	240	259	278	297	316	335	354	373	392	411
L ₂	27	46	65	84	103	122	141	160	179	198	217	236	255	274	293	312	331	350	369	388

⚠ Precautions

Be sure to read before handling. For Safety Instructions and Solenoid Valve Precautions, refer to page 3-13-2.

How to Wire DIN Terminal

⚠ Caution

- Connection
- 1. Loosen the set screw and pull out the connector from the terminal block of the solenoid.
- 2. Remove screw and insert screwdriver into the slit area near the bottom of terminal block to separate block and housing.
- 3. Loosen the terminal screws (slotted screws) on the terminal block, insert the core of the lead wire into the terminal, and attach securely with the terminal screws.
- 4. Tighten the ground nut to secure the wire.

⚠ Caution

Use caution in wiring because it will not meet the IP65 (enclosure) standard if you use the other cord than prescribed heavy-duty cord of size (ø3.5 to ø7.5).
Tighten the ground nut and set screw within the specified range of torque.

- **Change of electrical entry (Orientation)**
After separating terminal block and housing, the cord entry direction can be changed by attaching the housing in the desired direction (4 directions in 90 increments).
* In the case of w/indicator light, avoid damaging the light with lead wire.

- **Precautions**
Plug a connector in or out vertically, never at an angle.
- **Applicable cable**
O.D. ø3.5 to ø7
(Reference)
0.5 mm² 2 core and 3 core wires equivalent to JIS C 3306

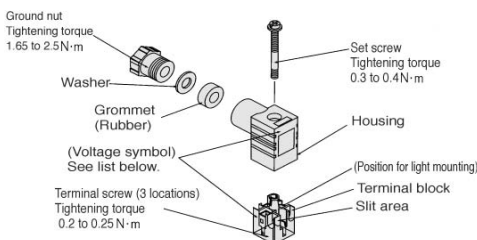

- **Connector part no.: VK300-82-1**
- **Part no. of connector with light**

Rated voltage	Voltage symbol	Part no.
100 VAC	100V	VK300-82-2-01
110 VAC	110V	VK300-82-2-03
200 VAC	200V	VK300-82-2-02
220 VAC	220V	VK300-82-2-04
240 VAC	240V	VK300-82-2-07
6 VDC	6V	VK300-82-4-51
12 VDC	12V	VK300-82-4-06
24 VDC	24VD	VK300-82-3-05
48 VDC	48VD	VK300-82-3-53

• Circuit with light

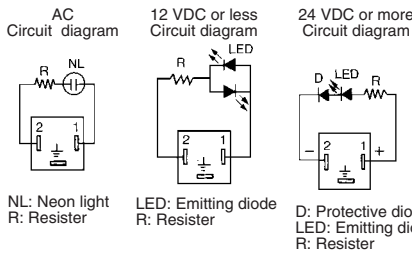

Light/Surge Voltage Suppressor

⚠ Caution

Rated voltage	Grommet type (G)	DIN terminal (D)	Part no. symbol
AC	With indicator light		S
	None		Z
24 V	With indicator light		S
	None		Z
DC	With indicator light		S
	None		Z
6 V	With indicator light		S
	None		Z
12 V	With indicator light		S
	None		Z

Precautions on connection for 24 VDC or more Grommet type should be connected as following; Red lead wire for (+) side, Black lead wire for (-) side respectively.

With the DIN terminal, connect the positive (+) side to the connector's no. 1 terminal, and the negative (-) side to the no. 2 terminal. [Refer to the marks on the terminal board.]

* For 12 VDC or below, there is no positive (+) or negative (-) directionality.

• Grommet type

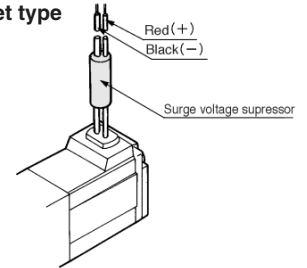

• DIN terminal

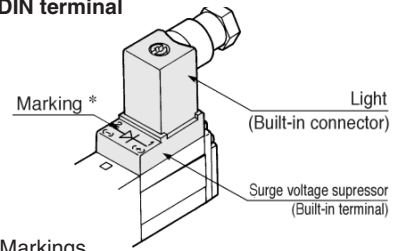

* Markings

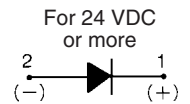
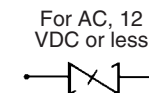

Valve Mounting Direction

⚠ Warning

When mounting a valve or spacer on the manifold base or sub-plate, etc., those mounting directions are determined. If mounted in the wrong direction, the equipment to be connected may cause malfunction. Refer to external dimensions in pages 3-2-4 to 3-2-10, and then mount it.

How to Calculate the Flow Rate

For obtaining the flow rate, refer to page 3-1-10.

VK

VZ

VF

VFR

VP4

VZS

VFS

VS4

VQ7

EVS

VFN