

Series VZ1000

Manifold Specifications

Manifold Standard

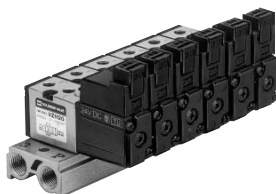

Manifold Specifications

Model	Type 20	
Manifold type	Single base/B mount	
P(SUP)/R(EXH)	Common SUP/Common EXH	
Valve stations	2 to 20 stations	
A, B port location	Valve	
Port size	1(P), 3(R) port	Rc 1/8
	4(A), 2(B) port	M5 x 0.8
Valve ^{Note)} effective area (mm ²)	VZ1120	1 → 4: 0.48, 4 → 3: 0.85

Note) Value at manifold base mounted, single operating

How to Order Manifold

Instruct by specifying the valves and blanking plate assembly to be mounted on the manifold along with the manifold base model no.

(Example) VV4Z1-20-031.....1 pc. (Manifold base)

*VZ1120-5G-M5.....2 pcs. (Valve)

*DXT170-25-1A.....1 pc. (Blanking plate assembly)

↳ The asterisk denotes the symbol for assembly. Prefix it to the part nos. of the solenoid valve, etc.

Flat Ribbon Cable Manifold

- **One-touch wiring to consolidate connection of external wires.**

- **Clean appearance**

The flat cable provides wiring on a printed circuit board to the individual valves at the manifold base, enabling the consolidation of external wiring at a touch through a 26 pins MIL connector.



Flat Ribbon Cable Manifold Specifications

Model	Type 21P	
Manifold type	Single base/B mount	
P(SUP), R(EXH)	Common SUP/Common EXH	
Valve stations	3 to 12 stations	
A, B port location	Valve	
Port size	1(P), 3(R) port	Rc 1/8
	4(A), 2(B) port	M5 x 0.8
Valve ⁽¹⁾ effective area (mm ²) (Cv factor)	VZ1120	1 → 4: 0.48, 4 → 3: 0.85
Applicable flat ribbon cable connector	Socket: 26 pins MIL, with strain relief (Conforming to MIL-C-83503)	
Internal wiring	+ COM (For – COM specifications, specify them separately.)	
Applicable valve model	VZ1120- $\frac{1}{6}$ MOZ-M5	
Rated voltage	100 VAC 50/60 Hz, 110 VAC 50/60 Hz, 24 VDC, 12 VDC	

Note 1) Value at manifold base mounted, single operating

Note 2) Withstand voltage specification of wiring unit part is equivalent to JIS C 0704 class 1.

How to Order Manifold

Instruct by specifying the valves, blanking plate assembly and connector assembly to be mounted on the manifold along with the manifold base model no.

(Example) VV4Z1-21P-07.....1 pc. (Manifold base)

*VZ1120-5MOZ-M5...6 pcs. (Valve)

*DXT170-25-3A.....1 pc. (Blanking plate assembly)

*DXT170-127-4A.....6 pcs. (Connector assembly)

↳ The asterisk denotes the symbol for assembly. Prefix it to the part nos. of the solenoid valve, etc.

VK

VZ

VF

VFR

VP4

VZS

VFS

VS4

VQ7

EVS

VFN

Series VZ1000

Common SUP/Common EXH

Note) For more than 10 stations, supply air to both sides of P port and exhaust air from both sides of R port.

Type 20

4(A), 2(B) port
M5×0.8

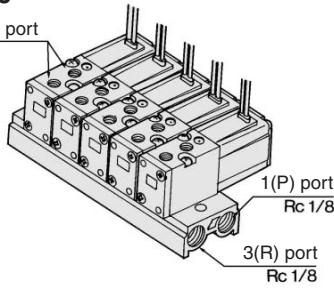

How to Order

VV4Z1-20-05 1-□-□

Stations	
02	2 stations
⋮	⋮
20	20 stations

P, R port
thread type

	Rc
Nil	Rc
00F	G
00N	NPT
00T	NPTF

Option

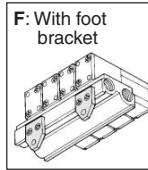

* Bracket is not mounted.

Applicable solenoid valve

VZ1120-□^G_L-□M5

Applicable blanking plate assembly
DXT170-25-1A

Individual EXH spacer assembly
DXT170-48-1A

Individual SUP spacer assembly
DXT170-44-1A

Flat Ribbon Cable Type 21P

4(A), 2(B) port
M5×0.8

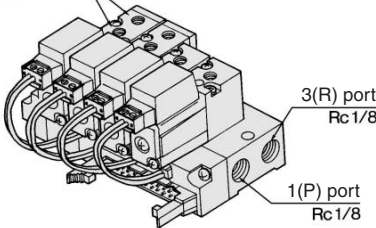

How to Order

VV4Z1-21P-05-□

Stations	
03	3 stations
⋮	⋮
12	12 stations

P, R port
thread type

	Rc
Nil	Rc
00F	G
00N	NPT
00T	NPTF

Applicable solenoid valve

VZ1120-¹/₃MOZ-M5

Applicable blanking plate assembly
DXT170-25-3A

Applicable connector assembly
DXT170-127-A

* 1: 100 VAC, 3: 110 VAC,
4: DC

Refer to page 3-3-7
regarding how to order
applicable connector
assemblies.

Option/Standard Manifold, Flat Ribbon Cable Manifold

Combinations of Solenoid Valve, Gasket and Manifold

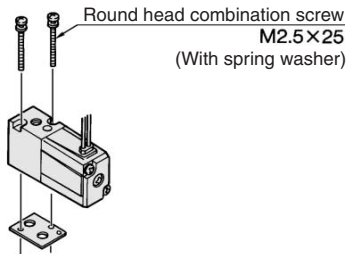

Applicable base
VV4Z1-20
VV4Z1-21P

Individual EXH Spacer Assembly

DXT170-48-1A

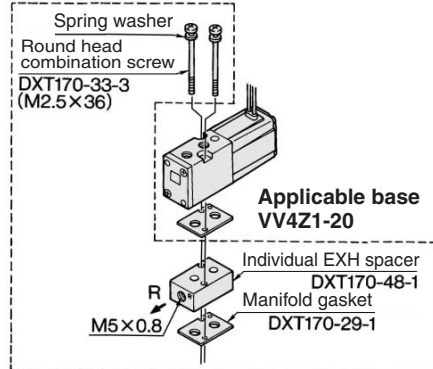

Individual SUP Spacer Assembly

DXT170-44-1A

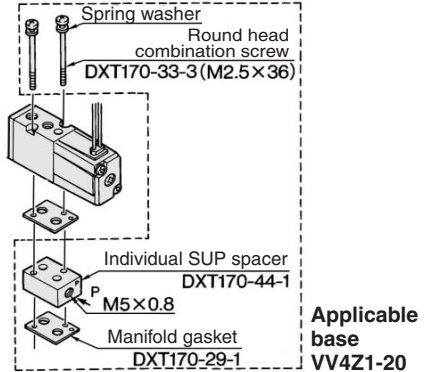

Note) Please contact SMC when using Individual EXH/SUP spacer assembly at 20P.

Mixed Mounting of the VZ110, 3 Port Valve on the Series VZ1000 Manifold Base

- A VZ110, 3 port valve can be mounted as is on the Series VZ1000 manifold base.
- The mounting direction is the same as the VZ1120.

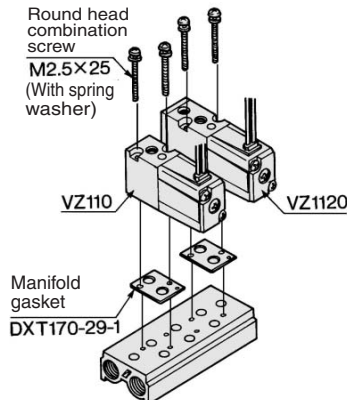

Applicable base
VV4Z1-20
VV4Z1-21P

Blanking Plate Assembly

DXT170-25-1A

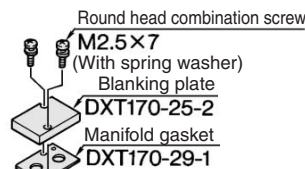

Applicable base
VV4Z1-20

Caution
Mounting Screw
Tightening Torques
M2.5: 0.45 N·m

DXT170-25-3A

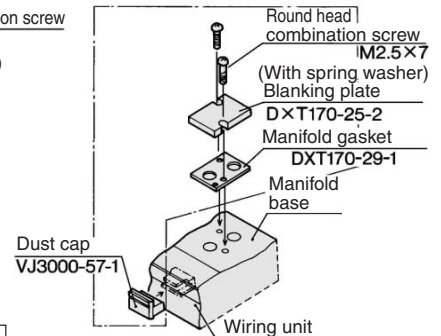

Applicable base
VV4Z1-21P

4 Port Solenoid Valve Body Ported Series VZ1000

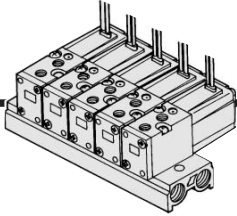

Type 20 Manifold

VV4Z1-20-Station 1-□

Grommet (G), (H)

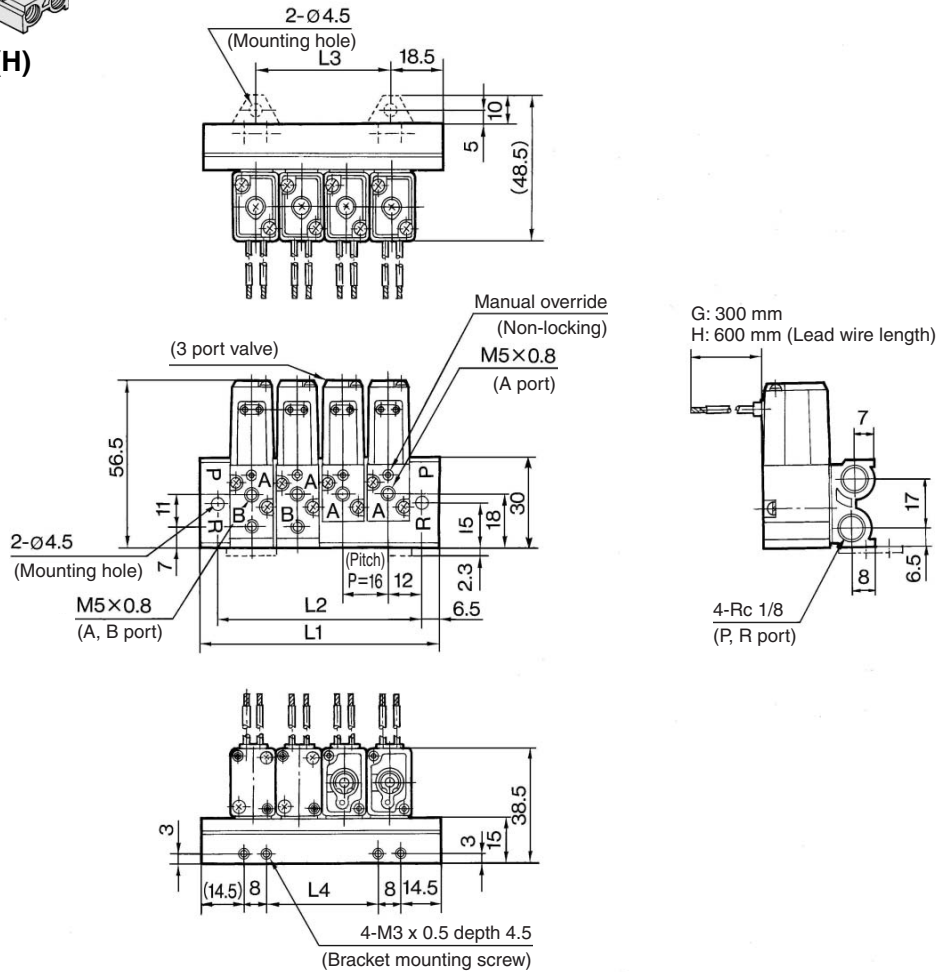

Stations	2	3	4	5	6	7	8	9	10	11	12	13	14	15	16	17	18	19	20
L1	53	69	85	101	117	133	149	165	181	197	213	229	245	261	277	293	309	325	341
L2	40	56	72	88	104	120	136	152	168	184	200	216	232	248	264	280	296	312	328
L3	16	32	48	64	80	96	112	128	144	160	176	192	208	224	240	256	272	288	304
L4	8	24	40	56	72	88	104	120	136	152	168	184	200	216	232	248	264	280	296

L plug connector (L)

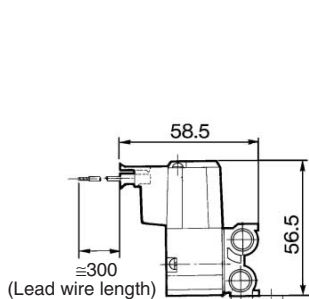

M plug connector (M)

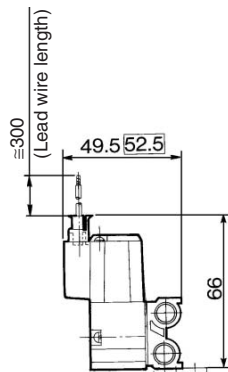

DIN terminal (D)

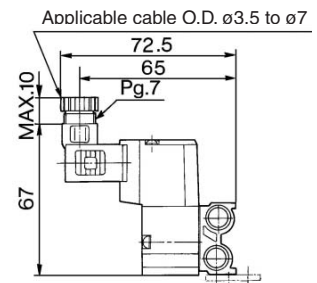

□: With light/surge voltage suppressor

VK

VZ

VF

VFR

VP4

VZS

VFS

VS4

VQ7

EVS

VFN

Series VZ1000

Type 21P Flat Ribbon Cable Manifold

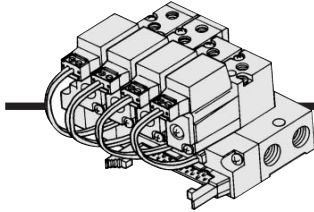

VV4Z1-21P-Station

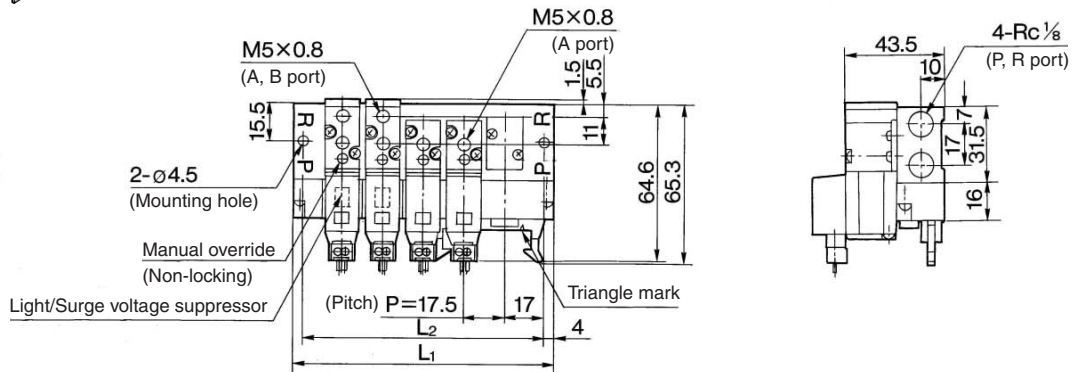

Station n..... Station 1

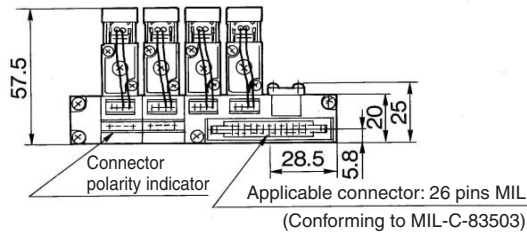

(mm)

Stations	3	4	5	6	7	8	9	10	11	12
L ₁	77	94.5	112	129.5	147	164.5	182	199.5	217	234.5
L ₂	69	86.5	104	121.5	139	156.5	174	191.5	209	226.5

Series VZ

Made to Order Specifications:

Please contact SMC for detailed specifications, dimensions, and delivery.

5. DIN Rail Manifold

DIN Rail Manifold

Common SUP/Common EXH

Note) For more than 11 stations, supply air to both sides of 1(P) port and exhaust air from both sides of 3(R) port.

Type 25 (Non plug-in type)

4(A), 2(B) port
M5×0.8

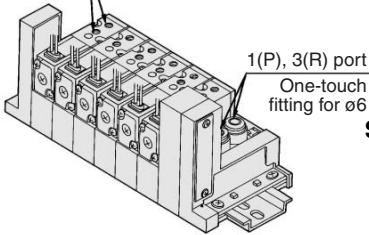

How to Order

VV4Z1 - 25 - 05 D - 00C

Stations

02	2 stations
⋮	⋮
20	20 stations

SUP/EXH block mounting position

U	U side: 2 to 10 stations
D	D side: 2 to 10 stations
B	Both sides: 2 to 20 stations
M	Special combination

Applicable solenoid valve

VZ1120-□^G_M□-M5

VZ110-□^G_M□-M5 (3 port valve)

Applicable blanking plate assembly

VZ1000-10-2A

DIN rail length specified

Nil	Standard length
3	For 3 stations (Specify a longer rail than the standard length.)
⋮	⋮
20	For 20 stations

Type 25F (Plug-in type)

4(A), 2(B) port
M5×0.8

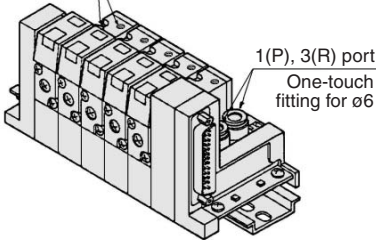

How to Order

VV4Z1 - 25F □ - 05 □ - 00C

Connector mounting direction

U	U side
D	D side

Stations

02	2 stations
⋮	⋮
20	20 stations

SUP/EXH block mounting position

Nil	For 2 to 10 stations : One side (Same as direction of connector mount) For 11 to 20 stations: Both sides
B	For 2 to 10 stations: Both sides
M*	Special combination

Applicable solenoid valve

VZ1120-□-FZ-M5

VZ110-□-FZ-M5 (3 port valve)

Applicable blanking plate assembly

VZ1000-10-1A

DIN rail length specified

Nil	Standard length
3	For 3 stations (Specify a longer rail than the standard length.)
⋮	⋮
20	For 20 stations

Option/DIN Rail Manifold

Note) 25 type is able to use with individual SUP spacer and individual EXH spacer assembly. Refer to page 3-3-14.

Combination of Solenoid Valve, Gasket and Manifold base

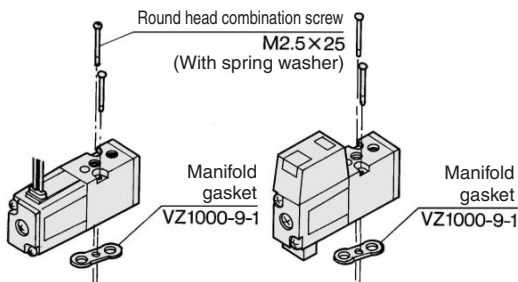

Applicable base
VV4Z1-25

Applicable base
VV4Z1-25F

Blanking Plate Assembly

VZ1000-10-2A

VZ1000-10-1A

EXH Block Disk

VZ1000-13-1A

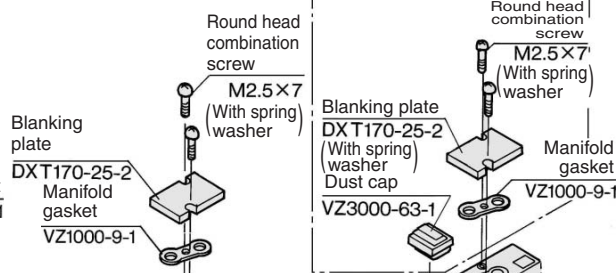

Applicable base
VV4Z1-25

Applicable base
VV4Z1-25F

By installing an EXH block disk in the exhaust passage of a manifold valve, it is possible to divide the valve's exhaust so that it does not affect another valve.

SUP Block Disk

VZ1000-13-1A

By installing a SUP block disk in the pressure supply passage of a manifold valve, it is possible to supply two or more different high and low pressures to one manifold.

Mix Mount with 3 Port Valve

3 port valve VZ110 can be mounted on VV4Z1-25 and VV4Z1-25F.

⚠ Caution

Mounting Screw Tightening Torques

M2.5: 0.32 N·m

(For stacking type manifold)

Series VZ1000

Exploded View/DIN Rail Manifold

Type 25 manifold

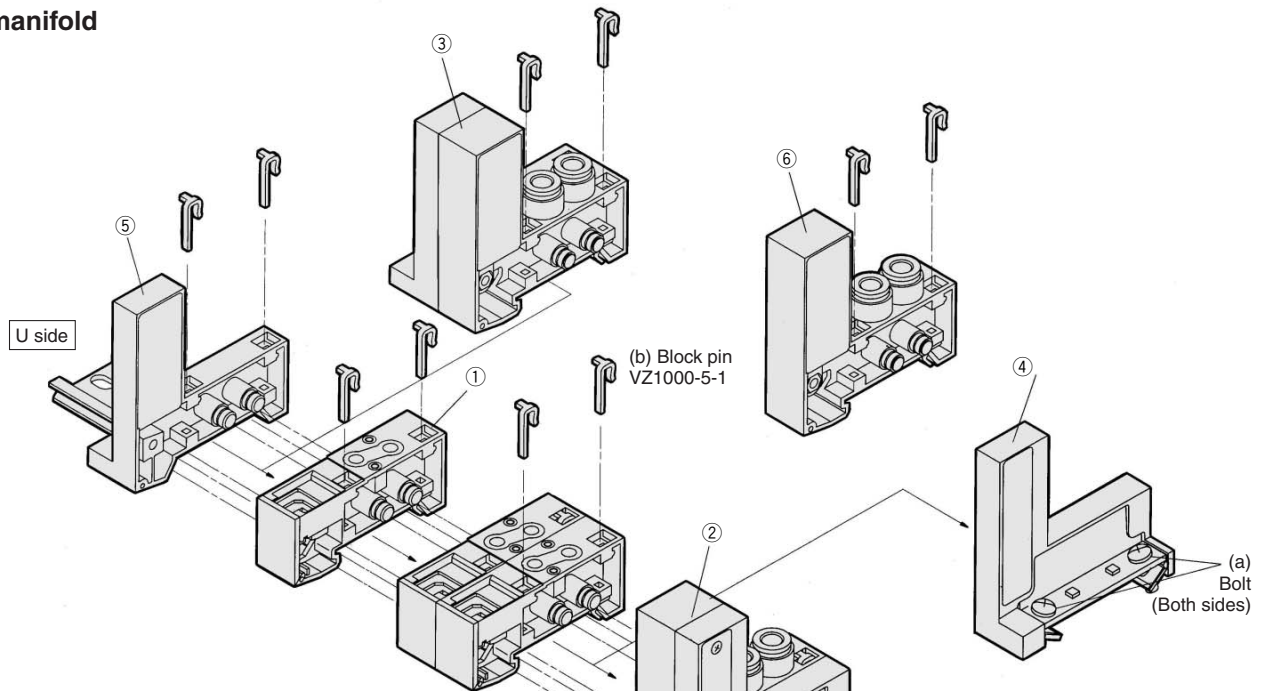

Replacement Parts

No.	Description	Part no.	Note
①	Manifold block assembly	VZ1000-1A-2	
②	SUP/EXH block assembly	VZ1000-2A-2D	For D side P/R port with One-touch fitting for $\phi 6$
③	SUP/EXH block assembly	VZ1000-2A-2U	For U side P/R port with One-touch fitting for $\phi 6$
④	End block assembly	VZ1000-3A-1D	For D side
⑤	End block assembly	VZ1000-3A-1U	For U side
⑥	SUP/EXH block assembly	VZ1000-2A-1M	Without D-sub connector For indicated location, P/R port with One-touch fitting for $\phi 6$

Note) Block pin (2 pcs.) is attached for ①, ③, ⑤, ⑥.

How to Increase Manifold Base

Station expansion is possible at any position.

- (1) Loosen (both) bolts (a), which are securing the manifold onto the DIN rail, 1 to 2 turns. (To remove the manifold base from the DIN rail, loosen the bolts 4 to 5 turns.)
- (2) Following the procedure shown in Fig. (2), pull the block pin (b) from the manifold block assembly at the location in which you wish to place an additional assembly.
- (3) Mount additional manifold block assembly on the DIN rail as shown in the Fig. (3).
- (4) Press the block assemblies and insert the block pin (b) to fix them to the DIN rail.
- (5) Tighten bolt (a) to fix the manifold to the DIN rail.

Note) When there are 10 or fewer manifold block assemblies, and more are added to make a total of 11 or more, a supply/exhaust block assembly must also be added.

Fig. (1)

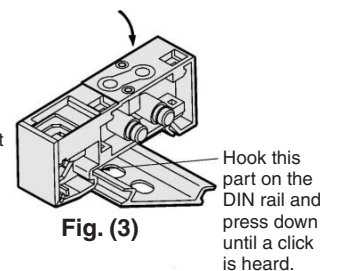
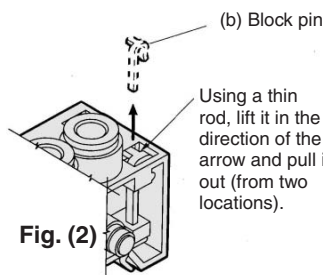
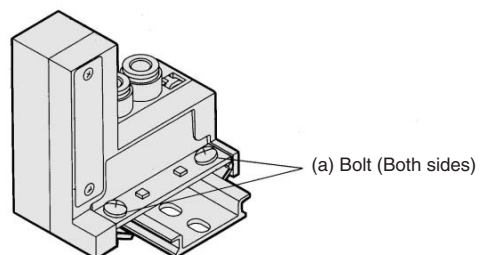

Exploded View/DIN Rail Manifold

Type 25F manifold

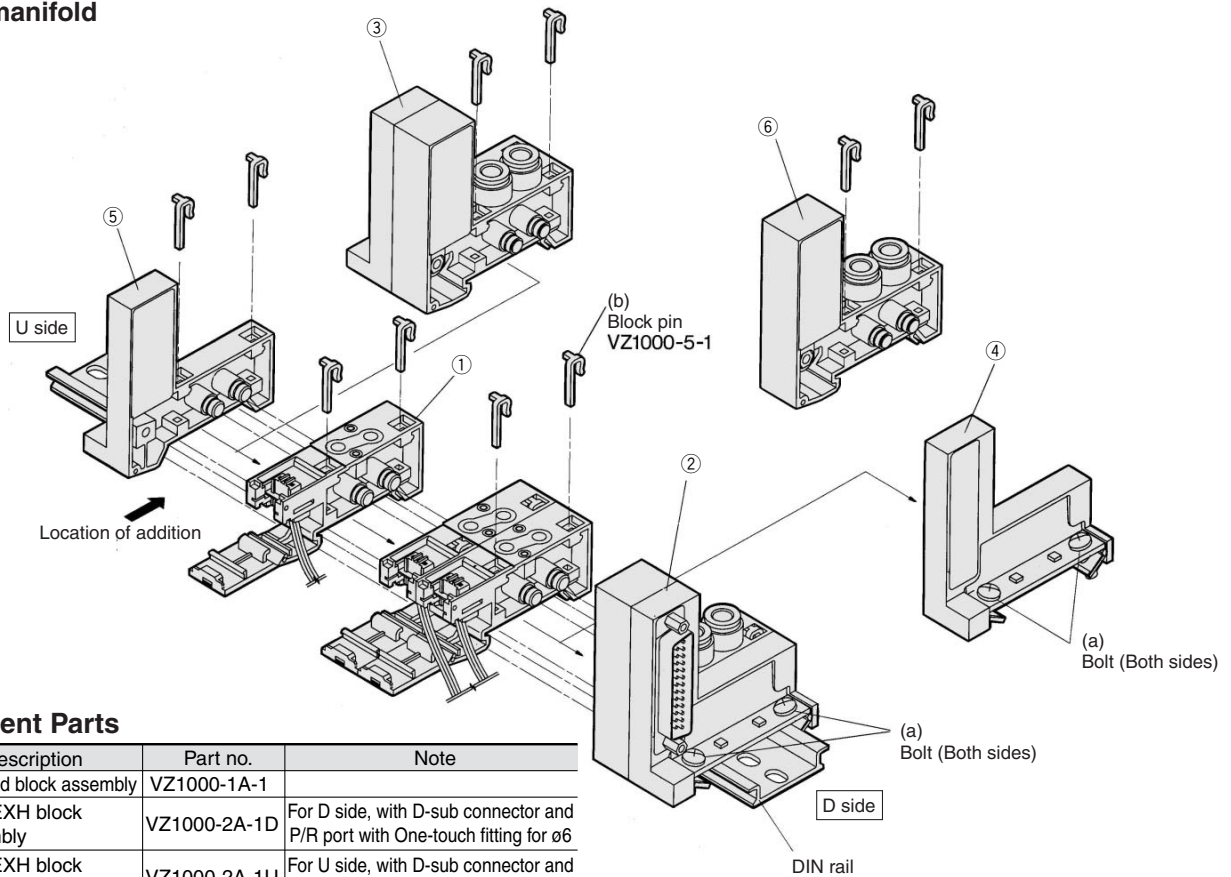

Replacement Parts

No.	Description	Part no.	Note
①	Manifold block assembly	VZ1000-1A-1	
②	SUP/EXH block assembly	VZ1000-2A-1D	For D side, with D-sub connector and P/R port with One-touch fitting for $\phi 6$
③	SUP/EXH block assembly	VZ1000-2A-1U	For U side, with D-sub connector and P/R port with One-touch fitting for $\phi 6$
④	End block assembly	VZ1000-3A-1D	For D side
⑤	End block assembly	VZ1000-3A-1U	For U side
⑥	SUP/EXH block assembly	VZ1000-2A-1M	Without D-sub connector For indicated location, P/R port with One-touch fitting for $\phi 6$

Note) Block pin (2 pcs.) is attached for ①, ③, ⑤, ⑥.

VK
VZ
VF
VFR
VP4
VZS
VFS
VS4
VQ7
EVS
VFN

How to Increase Manifold Base

To add a manifold block assembly, add it to the U side so that the terminal number of the D-sub connector and the valve link position will be in accordance with the circuit diagram.

- Loosen (both) bolts (a), which are securing the manifold onto the DIN rail, 1 to 2 turns. (To remove the manifold base from the DIN rail, loosen the bolts 4 to 5 turns.)
- Following the procedure shown in Fig. (1), pull out the block pin (b) from the block assembly that links the manifold block assembly of the U side and the D side with the end block assembly or the supply/exhaust end block assembly.
- Remove the housing cover from the D-sub connector portion of the supply/exhaust block assembly. (Refer to Fig. (3).)
- Following the procedure shown in Fig. (2), mount the manifold block assembly to be added onto the DIN rail. As shown in Fig. (4), insert the pin of the lead wire assembly into the D-sub connector, and attach the round crimped terminal to the screw that connects the wires.
- Press block assembly and insert block pin (b). to fix them to the DIN rail.
- Tighten bolt (a) to fix the manifold to the DIN rail.

Note) When there are 10 or fewer manifold block assemblies, and more are added to make a total of 11 or more, a supply/exhaust block assembly must also be added.

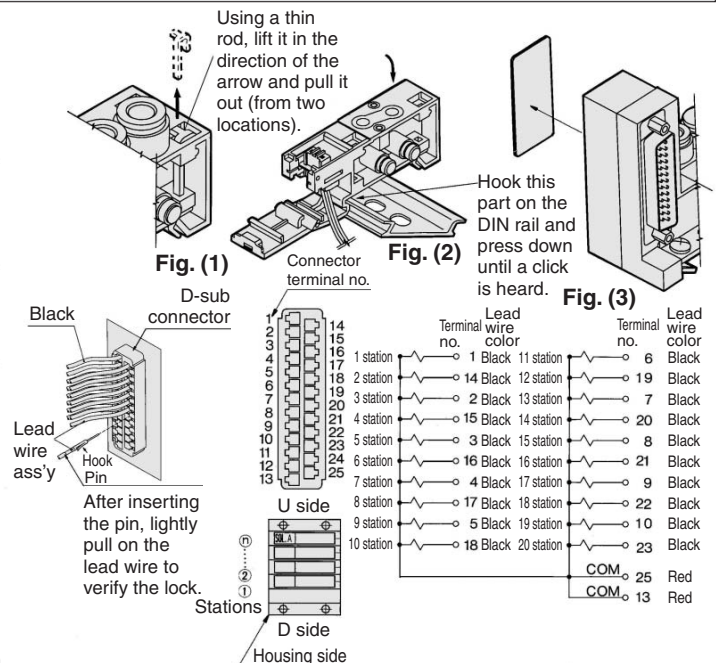

Fig. (4) How to insert lead wire assembly pin.

Series VZ

Made to Order Specifications:

Please contact SMC for detailed specifications, dimensions, and delivery.

5. DIN Rail Manifold

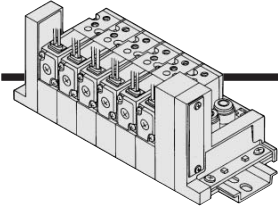

Type 25 DIN Rail Manifold (Non plug-in)

VV4Z1-25-Station D-00C

VV4Z1-25-Station B-00C

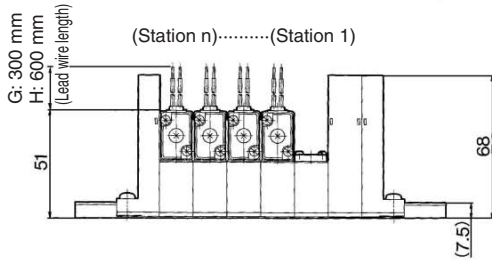
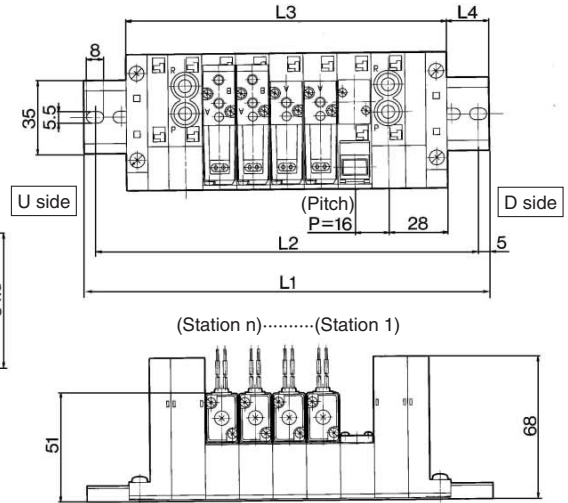
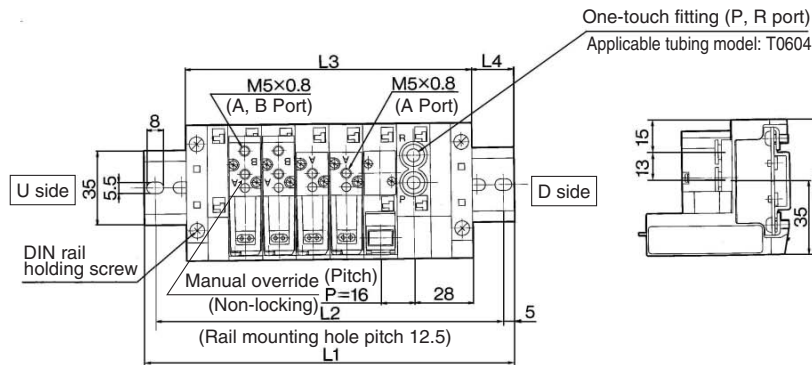

Stations	2	3	4	5	6	7	8	9	10
L ₁	110.5	135.5	148	160.5	185.5	198	210.5	223	248
L ₂	100	125	137.5	150	175	187.5	200	212.5	237.5
L ₃	88	104	120	136	152	168	184	200	216
L ₄	11.5	16	14	12.5	17	15	13.5	11.5	16

Stations	2	3	4	5	6	7	8	9	10
L ₁	135.5	148	160.5	185.5	198	210.5	223	248	260.5
L ₂	125	137.5	150	175	187.5	200	212.5	237.5	250
L ₃	104	120	136	152	168	184	200	216	232
L ₄	16	14	12.5	17	15	13.5	11.5	16	14

Stations	11	12	13	14	15	16	17	18	19	20
L ₁	273	298	310.5	323	335.5	360.5	373	385.5	398	423
L ₂	262.5	287.5	300	312.5	325	350	362.5	375	387.5	412.5
L ₃	248	264	280	296	312	328	344	360	376	392
L ₄	12.5	17	15.5	13.5	12	16.5	14.5	13	11	15.5

L plug connector (L)

M plug connector (M)

DIN terminal (D)

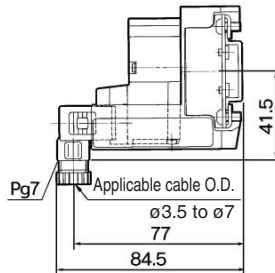
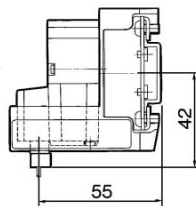
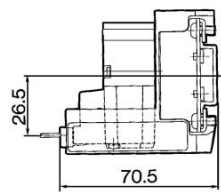

VV4Z1-25-Station U-00C

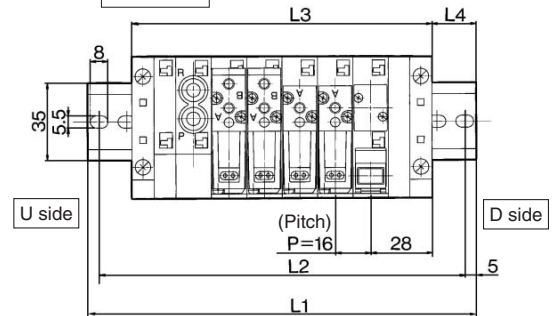

Stations	2	3	4	5	6	7	8	9	10
L ₁	110.5	135.5	148	160.5	185.5	198	210.5	223	248
L ₂	100	125	137.5	150	175	187.5	200	212.5	237.5
L ₃	88	104	120	136	152	168	184	200	216
L ₄	11.5	16	14	12.5	17	15	13.5	11.5	16

Series VZ

Made to Order Specifications:

Please contact SMC for detailed specifications, dimensions, and delivery.

6. DIN Rail Manifold

Type 25F DIN Rail Manifold (Plug-in)

VV4Z1-25FD-Station-00C (2 to 10 stations)

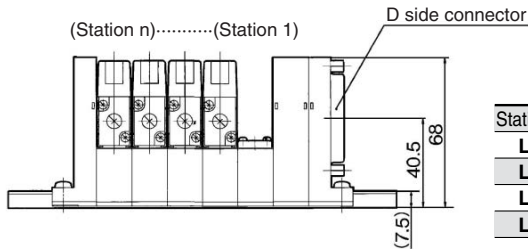
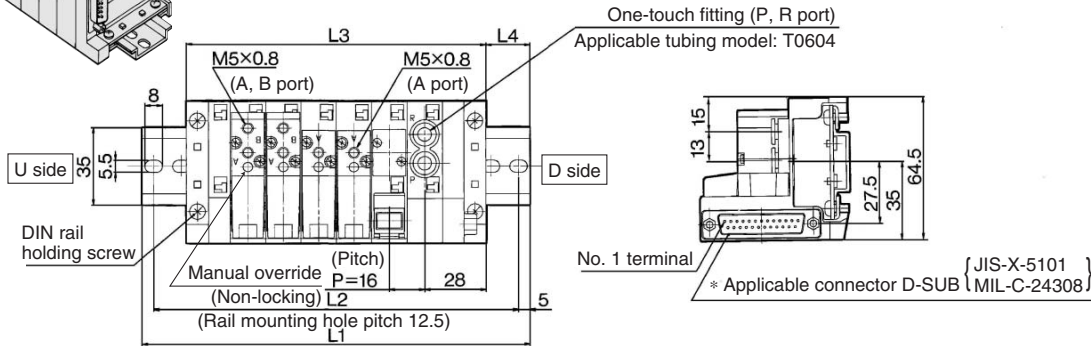
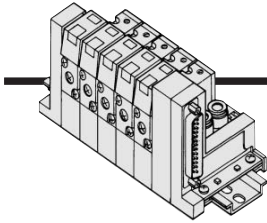

Stations	2	3	4	5	6	7	8	9	10
L ₁	110.5	135.5	148	160.5	185.5	198	210.5	223	248
L ₂	100	125	137.5	150	175	187.5	200	212.5	237.5
L ₃	88	104	120	136	152	168	184	200	216
L ₄	11.5	16	14	12.5	17	15	13.5	11.5	16

VV4Z1-25FU-Station-00C (2 to 10 stations)

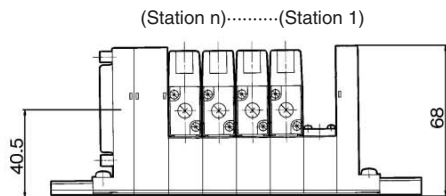
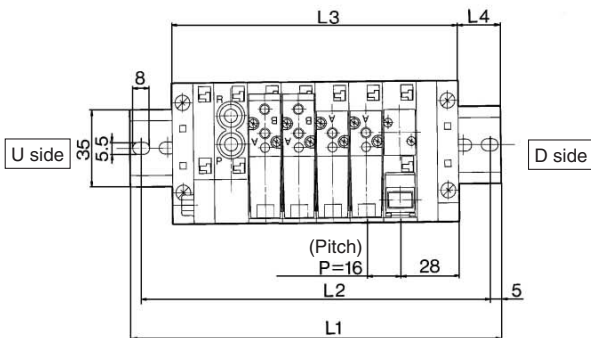

Stations	2	3	4	5	6	7	8	9	10
L ₁	110.5	135.5	148	160.5	185.5	198	210.5	223	248
L ₂	100	125	137.5	150	175	187.5	200	212.5	237.5
L ₃	88	104	120	136	152	168	184	200	216
L ₄	11.5	16	14	12.5	17	15	13.5	11.5	16

VV4Z1-25F_D-Station B-00C (2 to 10 stations)

VV4Z1-25F_D-Station-00C (11 to 20 stations)

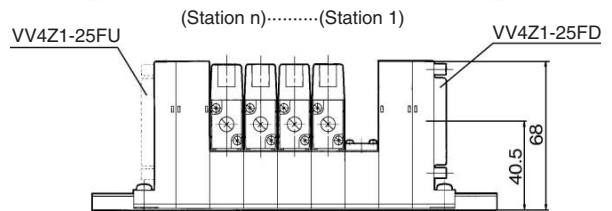
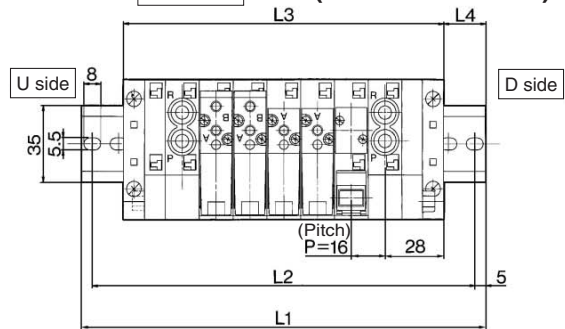

Stations	2	3	4	5	6	7	8	9	10
L ₁	135.5	148	160.5	185.5	198	210.5	223	248	260.5
L ₂	125	137.5	150	175	187.5	200	212.5	237.5	250
L ₃	104	120	136	152	168	184	200	216	232
L ₄	16	14	12.5	17	15	13.5	11.5	16	14

Stations	11	12	13	14	15	16	17	18	19	20
L ₁	273	298	310.5	323	333.5	360.5	373	385.5	398	423
L ₂	262.5	287.5	300	312.5	325	350	362.5	375	387.5	412.5
L ₃	248	264	280	296	312	328	344	360	376	392
L ₄	12.5	17	15.5	13.5	12	16.5	14.5	13	11	15.5

- VK
- VZ**
- VF
- VFR
- VP4
- VZS
- VFS
- VS4
- VQ7
- EVS
- VFN