

# Electric Actuator

High Performance

New



\* For details, refer to page 45.



## High Rigidity and High Precision Slider Type

Battery-less Absolute (Step Motor 24 VDC)

### Reduces cycle time

Cycle time

Reduced by **39%** (0.57 s ← 0.93 s)  
compared with the existing model\*<sup>1</sup>

\*<sup>1</sup> When LEKFS25GH-400 is operated from 0 to 400 mm (stroke)

Acceleration/  
Deceleration

**10000 mm/s<sup>2</sup>**

(334% increase compared with the existing model)

Max. speed

**1500 mm/s**

(Improved by 25% compared with the existing model)

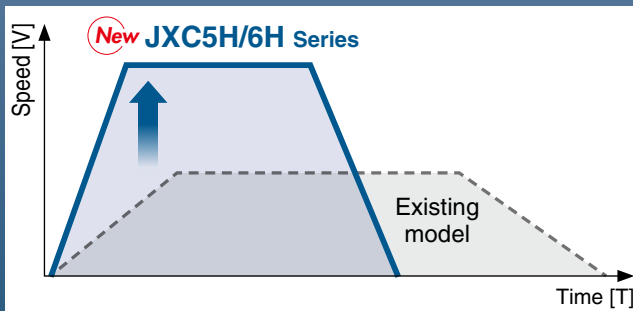

### Easy operation restart after recovery of the power supply

The position information is held by the encoder even when the power supply is turned off. A return to origin operation is not necessary when the power supply is recovered.

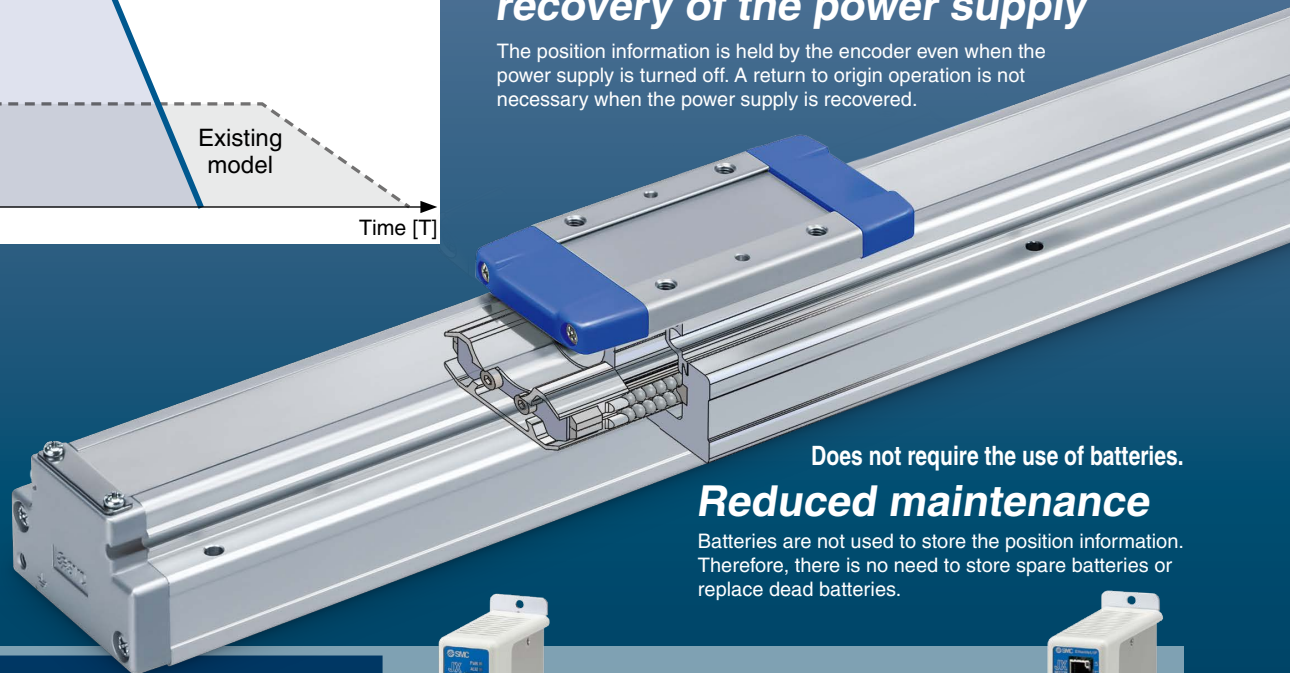

Does not require the use of batteries.

### Reduced maintenance

Batteries are not used to store the position information. Therefore, there is no need to store spare batteries or replace dead batteries.

### High Performance Step Motor Controller

Higher acceleration and maximum speed can be set with the special controller (for LEKFS□G Series).

Parallel I/O

JXC5H/6H Series p. 31



EtherCAT/EtherNet/IP™/  
PROFINET

JXCEH/9H/PH Series p. 38



LEKFS□G Series



CAT.ES100-151A

# With a 4-row circular arc on each side for high rigidity and high precision (zero clearance)

## Improved moment resistance

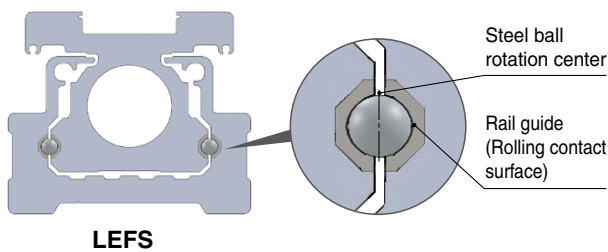
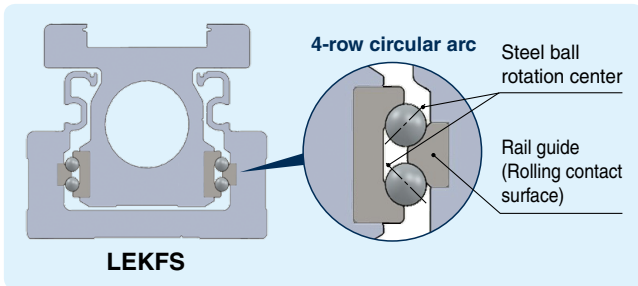

### Improved Dynamic Allowable Moment

Size	Moment direction	Work load [kg] (Overhang: 300 mm)	
		High rigidity guide LEKFS	LEFS
25	Pitching (Mep)	7.5 (10% increase)	6.8
32		18 (35% increase)	13.3
40		37 (61% increase)	23

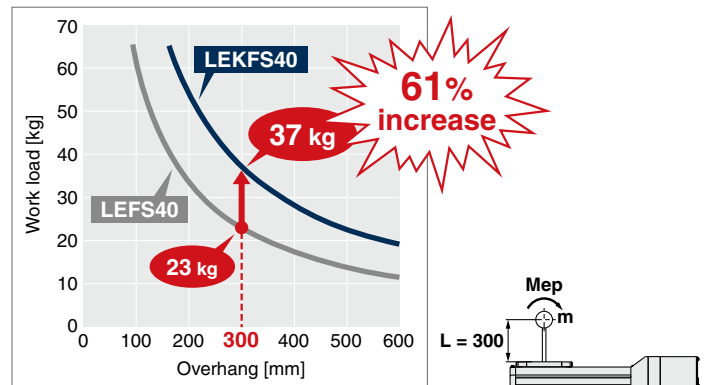

## Table displacement amount reduced to 1/2

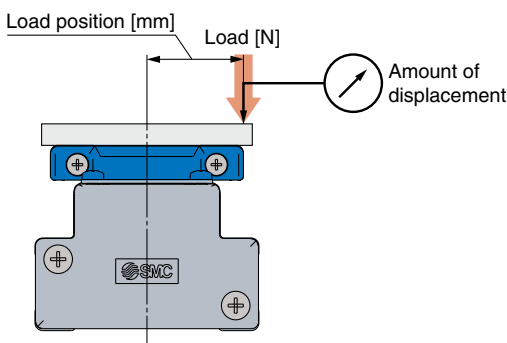

### Table Displacement

Size	Table displacement [mm]		Load position [mm]	Load [N]
	High rigidity guide LEKFS	LEFS		
25	0.022 (50% reduction)	0.044	25	200
32	0.036 (50% reduction)	0.072	30	450
40	0.027 (50% reduction)	0.053	37	500

## Zero table clearance

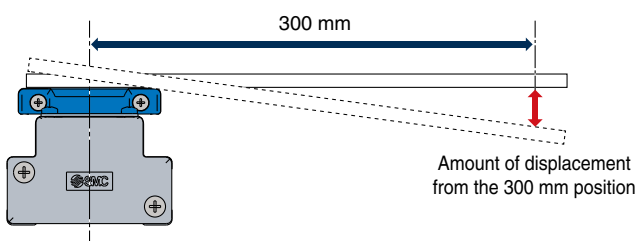

### Table Clearance

Size	Displacement due to table clearance [mm]	
	High rigidity guide LEKFS	LEFS
25	0	0.079
32	0	0.068
40	0	0.052

\* The image shows the displacement amount with zero load.

## Auto switches are mountable.

Allows for position detection of the table throughout the stroke

LEKFS32/40

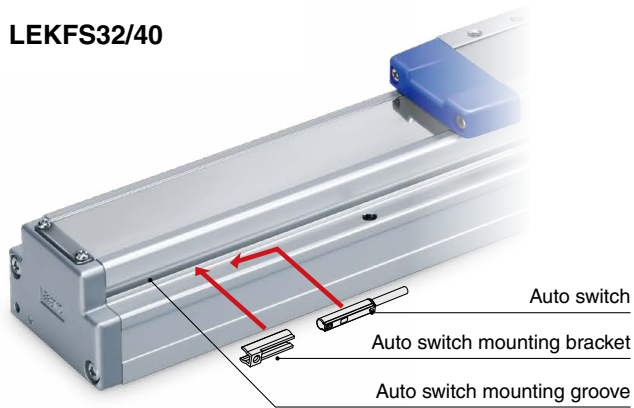

LEKFS25



## Same dimensions as the LEF/Complete mounting compatibility is ensured.

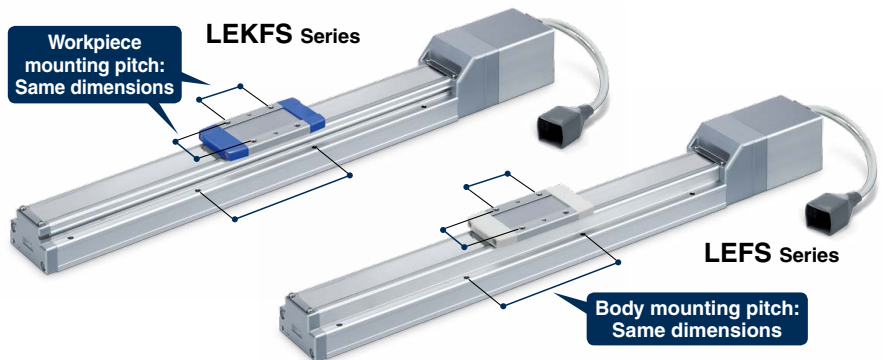
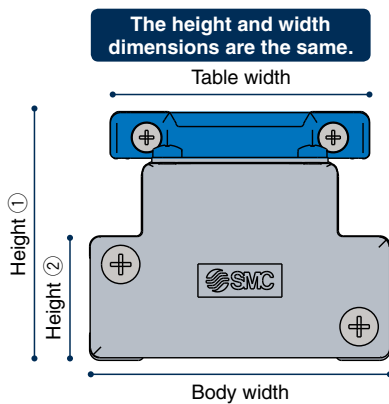

## The body bottom positioning pin holes have been standardized.

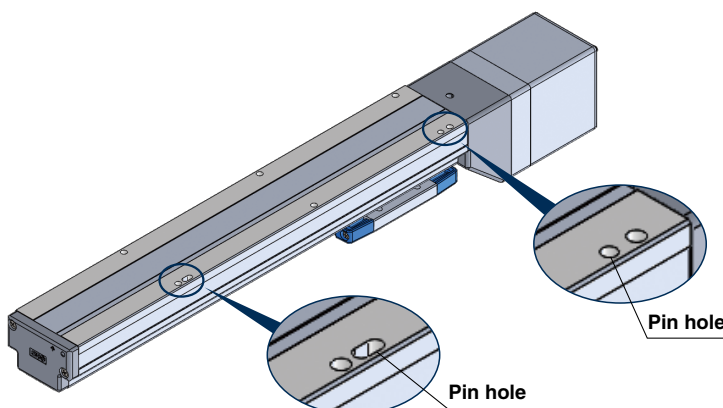

## Magnet for adhesion of the dust seal band

Improved adhesion enhances the dustproof performance and reduces dust seal band blistering.

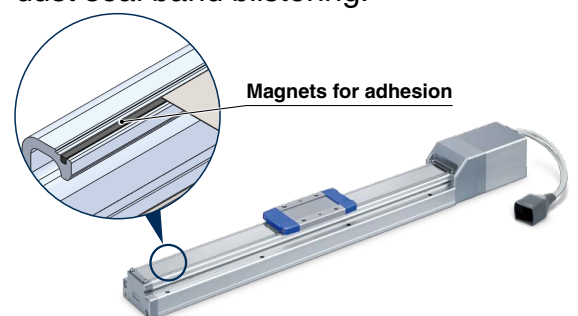



**ACT 2**

**Controller Setting Software ACT Controller 2**

**Easy-to-use setting software ACT Controller 2 (For PC)**

**Various functions available in normal mode** (Compared with the existing ACT Controller)

● **Parameter and step data setting**

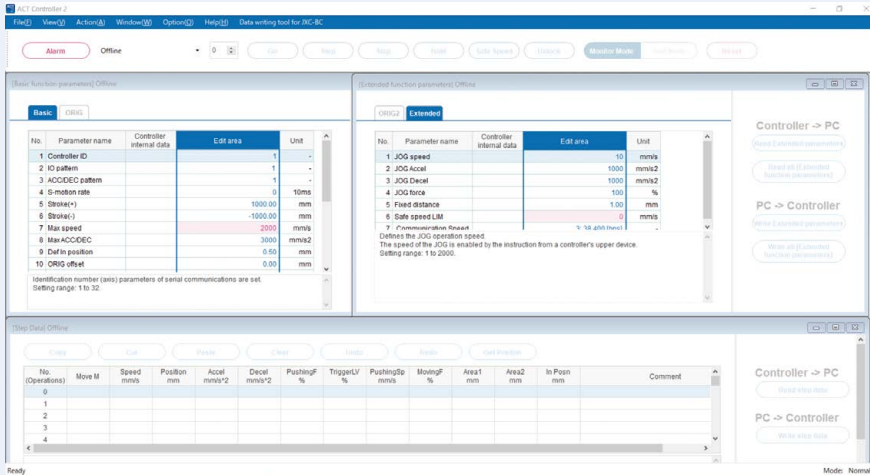

\* Customers operating computers with specifications other than Windows 10/64 bit should use the existing ACT Controller.

● **Alarm confirmation**

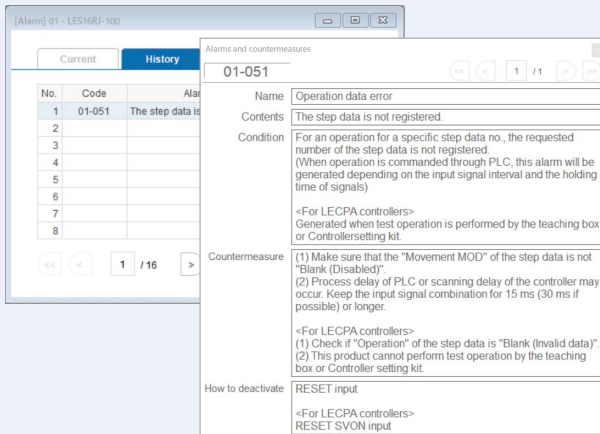

When an alarm is generated, the alarm details and countermeasures can be confirmed.

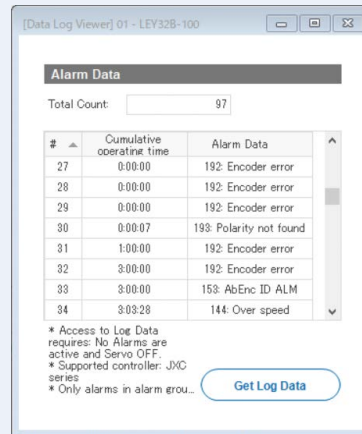

When an alarm is generated, the cumulative start-up time of the controller can be confirmed.

● **Waveform monitoring**

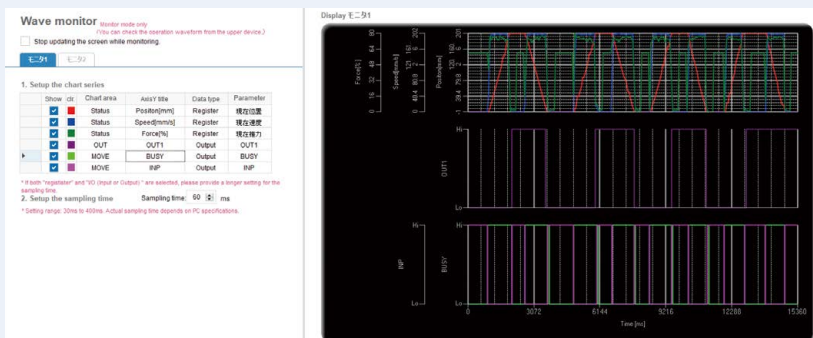

The position, speed, force, and input/output signals' waveform data during operation can be measured.

\* When using the ACT Controller 2 test operation function, waveform monitoring is not available.

Step Data Input Type JXC5H/6H Series **p. 31**



**ACT 2**

**Controller Setting Software ACT Controller 2**

• **The JXC-BC writing tool**

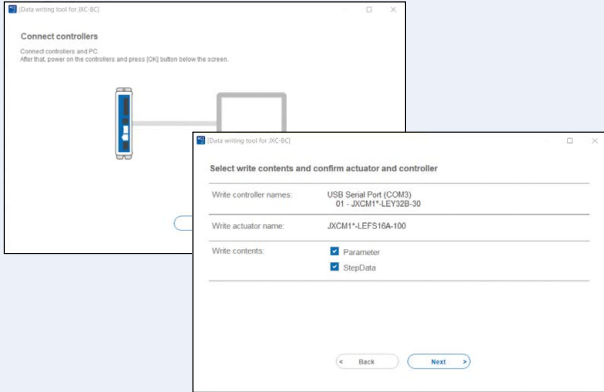

The writing tool can be used to write the connected actuator's parameters and step data to a JXC series blank controller.

• **Customizable plug-in functions**

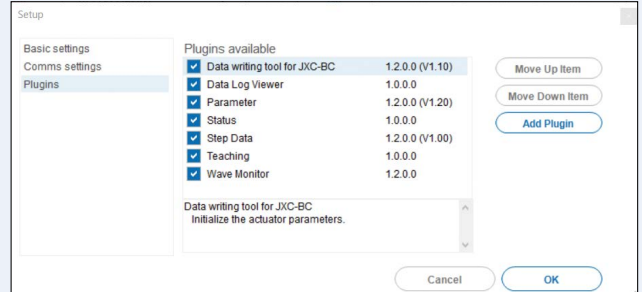

Which plug-in functions are displayed as well as the display order are customizable. Customers can add the functions they require.

In normal mode, various other test operation methods (program operation, jogging, moving of the constant rate, etc.), signal status monitoring, one-touch switching between Japanese and English, and other functions are available.

**For immediate use, operate in easy mode.**

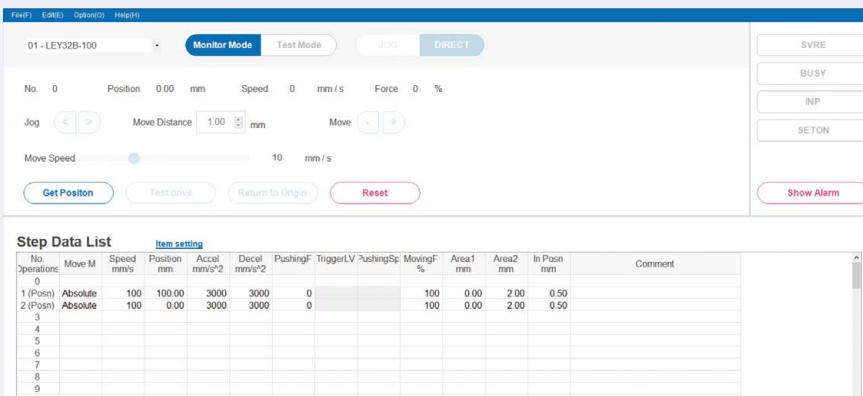

Step data setting, various test operations, and status confirmation can be done on a single screen.

**How to download the setting software**

[Click here for details.](#)

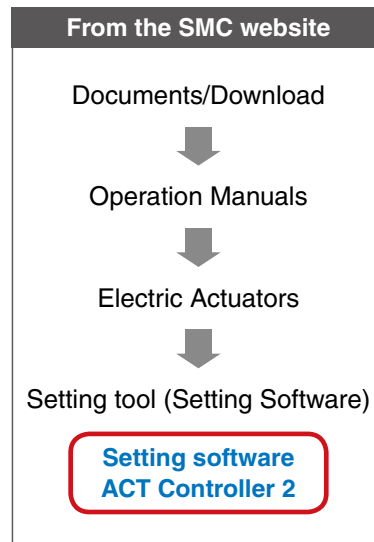
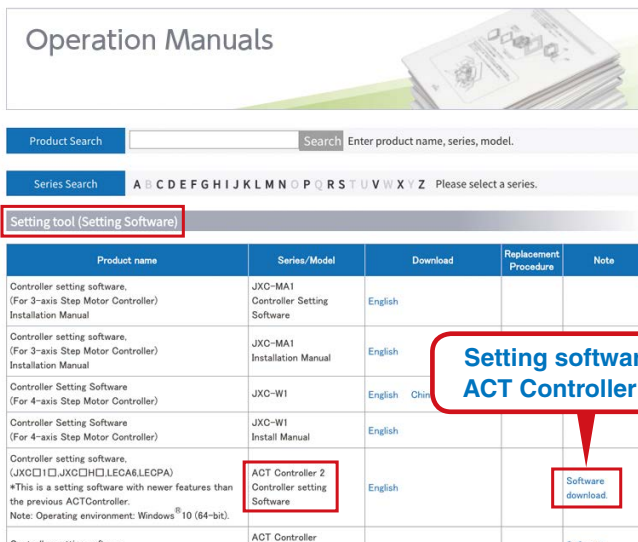

Step Data Input Type JXC5H/6H Series **p. 31**



**Teaching Box**

◎ **Normal Mode**

- Multiple step data can be stored in the teaching box and transferred to the controller.
- Continuous test drive by up to 5 step data

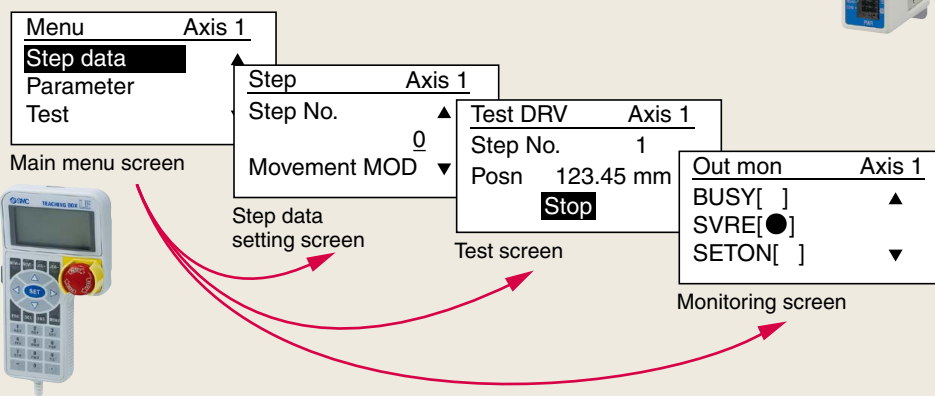

**Teaching box screen**

- Each function (step data setting, test drive, monitoring, etc.) can be selected from the main menu.

◎ **Easy Mode**

- The simple screen without scrolling promotes ease of setting and operation.
- Choose an icon from the first screen to select a function.
- Set the step data and check the monitor on the second screen.



**Example of setting the step data**

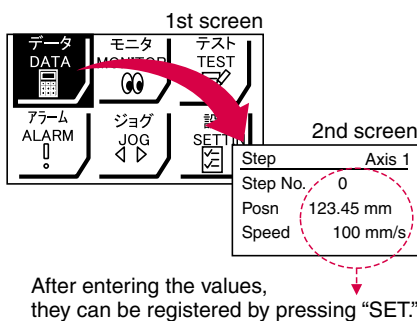

**Example of checking the operation status**

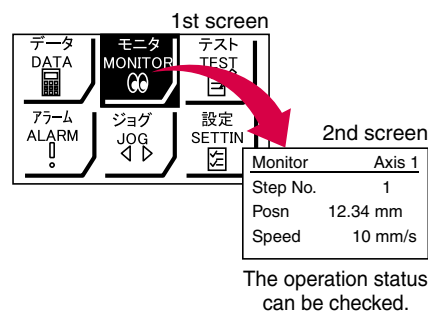

**Teaching box screen**

- Data can be set by inputting only the position and speed. (Other conditions are preset.)

Step	Axis 1
Step No.	0
Posn	50.00 mm
Speed	200 mm/s



Step	Axis 1
Step No.	1
Posn	80.00 mm
Speed	100 mm/s

**The actuator and controller are provided as a set.** (They can be ordered separately as well.)

Confirm that the combination of the controller and actuator is correct.

<Check the following before use.>

- ① Check the actuator label for the model number. This number should match that of the controller.
- ② Check that the Parallel I/O configuration matches (NPN or PNP).

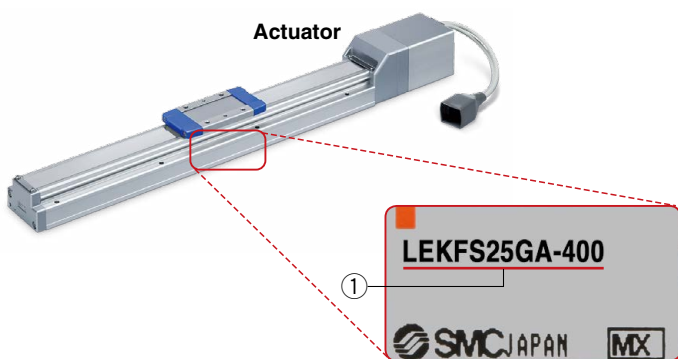

## Function

Item	Step data input type JXC5H/6H
Step data and parameter setting	<ul style="list-style-type: none"> <li>Input from controller setting software (PC)</li> <li>Input from teaching box</li> </ul>
Step data “position” setting	<ul style="list-style-type: none"> <li>Numerical value input from controller setting software (PC) or teaching box</li> <li>Input numerical value</li> <li>Direct teaching</li> <li>JOG teaching</li> </ul>
Number of step data	64 points
Operation command (I/O signal)	Step No. [IN <sup>+</sup> ] input ⇒ [DRIVE] input
Completion signal	[INP] output

## Setting Items

TB: Teaching box PC: Controller setting software

Item		Contents	Easy Mode		Normal Mode	Step data input type JXC5H/6H
			TB	PC	TB/PC	
Step data setting (Excerpt)	Movement MOD	Selection of “absolute position” and “relative position”	△	●	●	Set at ABS/INC
	Speed	Transfer speed	●	●	●	Set in units of 1 mm/s
	Position	[Position]: Target position [Pushing]: Pushing start position	●	●	●	Set in units of 0.01 mm
	Acceleration/Deceleration	Acceleration/deceleration during movement	●	●	●	Set in units of 1 mm/s <sup>2</sup>
	Pushing force	Rate of force during pushing operation	●	●	●	Set in units of 1%
	Trigger LV	Target force during pushing operation	△	●	●	Set in units of 1%
	Pushing speed	Speed during pushing operation	△	●	●	Set in units of 1 mm/s
	Moving force	Force during positioning operation	△	●	●	Set to 100%
	Area output	Conditions for area output signal to turn ON	△	●	●	Set in units of 0.01 mm
	In position	[Position]: Width to the target position [Pushing]: How much it moves during pushing	△	●	●	Set to 0.5 mm or more (Units: 0.01 mm)
Parameter setting (Excerpt)	Stroke (+)	+ side position limit	×	×	●	Set in units of 0.01 mm
	Stroke (-)	- side position limit	×	×	●	Set in units of 0.01 mm
	ORIG direction	Direction of the return to origin can be set.	×	×	●	Compatible
	ORIG speed	Speed during return to origin	×	×	●	Set in units of 1 mm/s
	ORIG ACC	Acceleration during return to origin	×	×	●	Set in units of 1 mm/s <sup>2</sup>
Test	JOG		●	●	●	Continuous operation at the set speed can be tested while the switch is being pressed.
	MOVE		×	●	●	Operation at the set distance and speed from the current position can be tested.
	Return to ORIG		●	●	●	Compatible
	Test drive	Operation of the specified step data	●	●	● (Continuous operation)	Compatible
	Forced output	ON/OFF of the output terminal can be tested.	×	×	●	Compatible
Monitor	DRV mon	Current position, speed, force, and the specified step data can be monitored.	●	●	●	Compatible
	In/Out mon	Current ON/OFF status of the input and output terminal can be monitored.	×	×	●	Compatible
ALM	Status	Alarm currently being generated can be confirmed.	●	●	●	Compatible
	ALM Log record	Alarms generated in the past can be confirmed.	×	×	●	Compatible
File	Save/Load	Step data and parameters can be saved, forwarded, and deleted.	×	×	●	Compatible
Other	Language	Can be changed to Japanese or English	●	●	●	Compatible

△: Can be set from TB Ver. 2.\*\* (The version information is displayed on the initial screen.)

## Fieldbus Network

# EtherCAT/EtherNet/IP™/PROFINET Direct Input Type Step Motor Controller/JXC□H Series p. 38

**ACT 2** Controller Setting Software  
ACT Controller 2



○ **Two types of operation command**

**Step no. defined operation:** Operate using the preset step data in the controller.  
**Numerical data defined operation:** The actuator operates using values such as position and speed from the PLC.

○ **Numerical monitoring available**

Numerical information, such as the current speed, current position, and alarm codes, can be monitored on the PLC.

○ **Transition wiring of communication cables**

Two communication ports are provided.

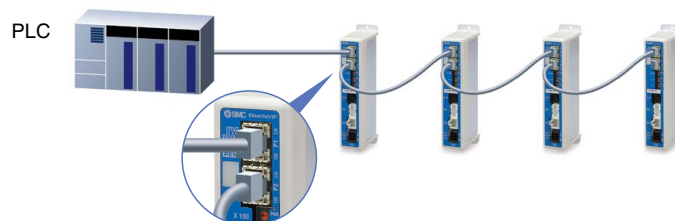

### Application

Communication protocols

**EtherCAT**

**EtherNet/IP**

**PROFINET**

PLC

Electric Actuators

Air Cylinders

EX260

**Both air and electric systems can be established under the same protocol.**

**ACT 2** Controller Setting Software ACT Controller 2 From p. 3

## Easy-to-use setting software ACT Controller 2 (For PC)

**Various functions available in normal mode** (Compared with the existing ACT Controller)

- Parameter and step data setting
- The JXC-BC writing tool
- Alarm confirmation
- Customizable plug-in functions
- Waveform monitoring

\* Customers operating computers with specifications other than Windows 10/64 bit should use the existing ACT Controller.



**System Construction/General Purpose I/O**

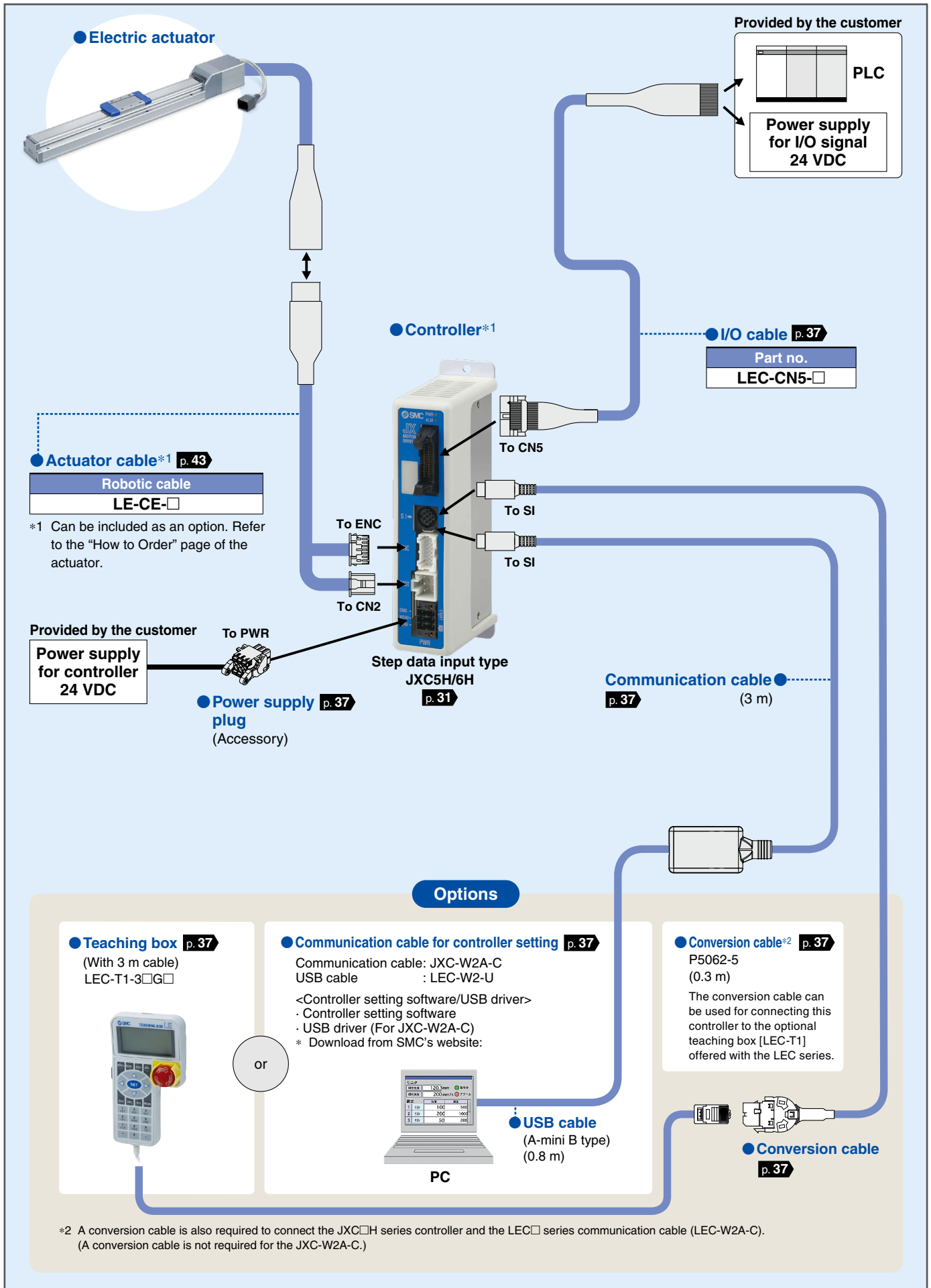

## System Construction/Fieldbus Network (EtherCAT/EtherNet/IP™/PROFINET Direct Input Type)

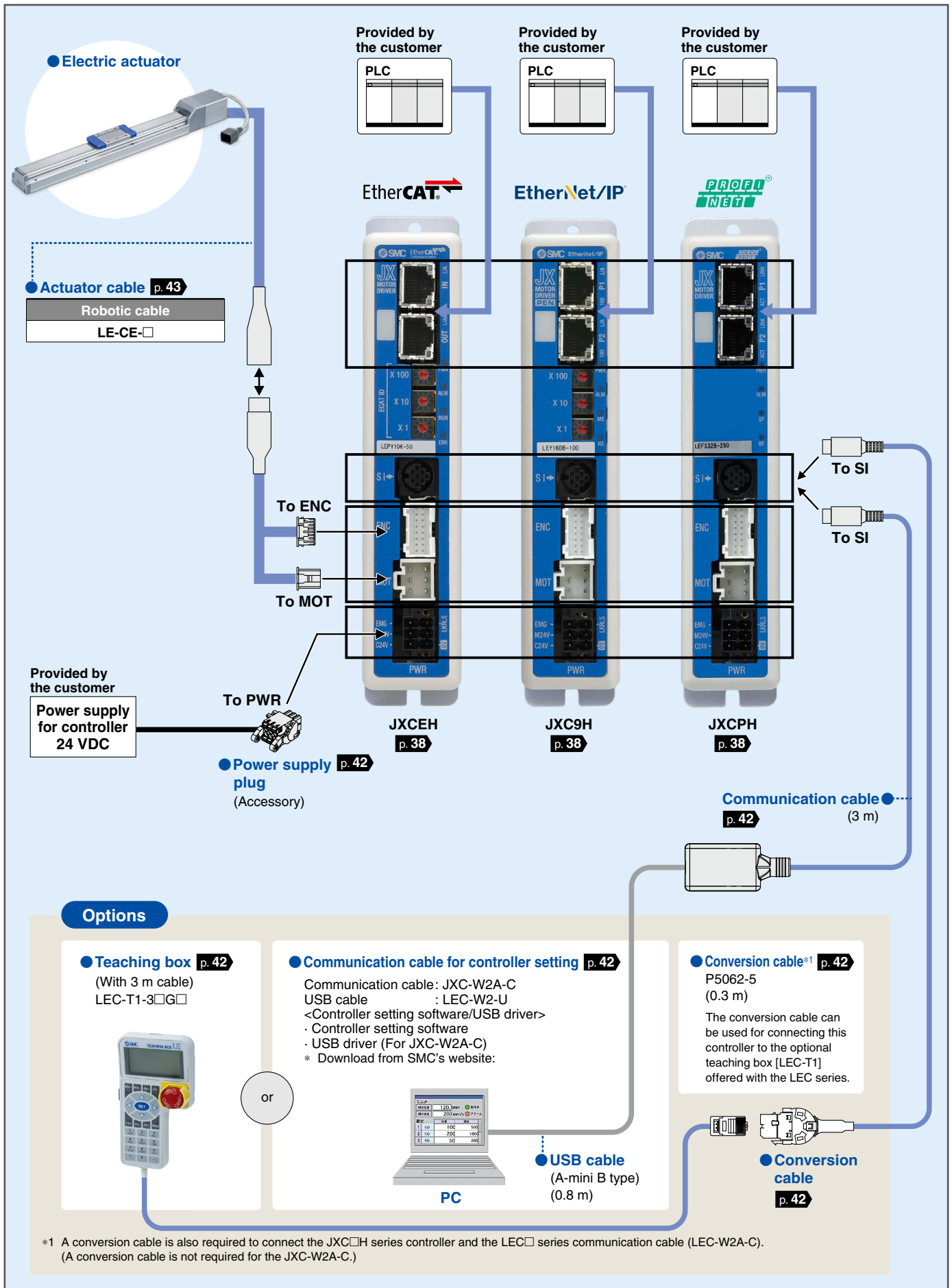

# Electric Actuator

## High Performance High Rigidity and High Precision Slider Type

### High Rigidity and High Precision Slider Type *LEKFS□G Series*

Battery-less Absolute (Step Motor 24 VDC)

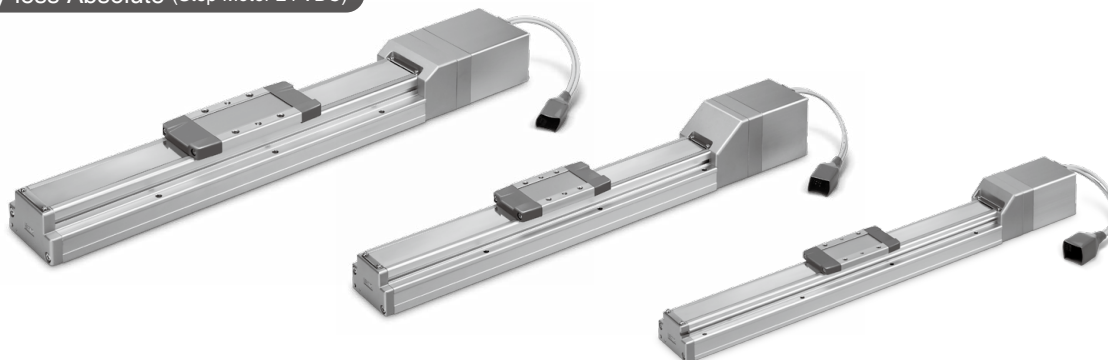

Model Selection

LEKFS□G Series

## CONTENTS

### High Performance High Rigidity and High Precision Slider Type *LEKFS□G Series* p. 10

Battery-less Absolute (Step Motor 24 VDC)

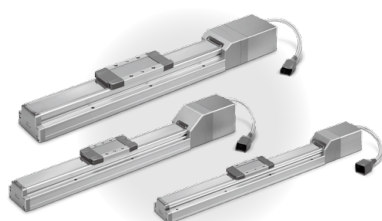

Model Selection .....	p. 11
How to Order .....	p. 18
Specifications .....	p. 20
Dimensions .....	p. 21
Auto Switch Mounting .....	p. 27

Auto Switch

JXC5H/6H Series

### Controllers *JXC□H Series* p. 30

#### High Performance Controller (Step Data Input Type) *JXC5H/6H Series* Battery-less Absolute (Step Motor 24 VDC)



How to Order .....	p. 31
Specifications .....	p. 31
Dimensions .....	p. 33
Options .....	p. 37
Actuator Cable .....	p. 43

#### High Performance Step Motor Controller *JXCEH/9H/PH Series* Battery-less Absolute (Step Motor 24 VDC)



How to Order .....	p. 38
Specifications .....	p. 39
Dimensions .....	p. 40
Options .....	p. 42
Actuator Cable .....	p. 43

JXCEH/9H/PH Series

Battery-less Absolute Encoder Type Specific Product Precautions ..... p. 44

CE/UKCA/UL-compliance List ..... p. 45

# Model Selection

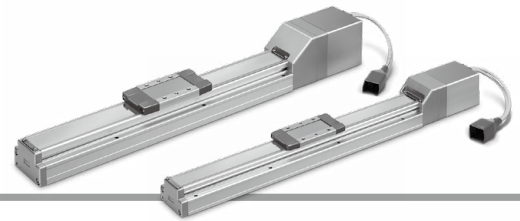

## Selection Procedure



## Selection Example

### Operating conditions

- Workpiece mass: 5 [kg]
  - Speed: 300 [mm/s]
  - Acceleration/Deceleration: 10000 [mm/s<sup>2</sup>]
  - Stroke: 200 [mm]
  - Mounting orientation: Horizontal upward
- Workpiece mounting condition:

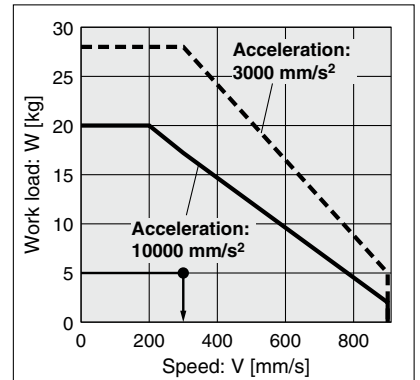
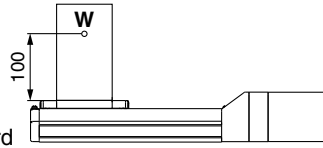

<Speed-Work load graph>  
(LEKFS25GA/Battery-less absolute)

**Step 1 Check the work load-speed.** <Speed-Work load graph> (pages 12 to 14)  
Select a model based on the workpiece mass and speed while referencing the speed-work load graph.  
Selection example) The **LEKFS25GA-200** can be temporarily selected as a possible candidate based on the graph shown on the right side.

**Step 2 Check the cycle time.**  
Calculate the **cycle time** using the following calculation method.  
**Cycle time:**  
T can be found from the following equation.

$$T = T1 + T2 + T3 + T4 \text{ [s]}$$

- T1: Acceleration time and T3: Deceleration time can be found by the following equation.

$$T1 = V/a1 \text{ [s]} \quad T3 = V/a2 \text{ [s]}$$

- T2: Constant speed time can be found from the following equation.

$$T2 = \frac{L - 0.5 \cdot V \cdot (T1 + T3)}{V} \text{ [s]}$$

- T4: Settling time varies depending on the conditions such as actuator types, load, and in position of the step data. Reference value for settling time: 0.15 [s] or less  
The following value is used for this calculation.

$$T4 = 0.15 \text{ [s]}$$

Calculation example)  
T1 to T4 can be calculated as follows.

$$T1 = V/a1 = 300/10000 = 0.03 \text{ [s]}$$

$$T3 = V/a2 = 300/10000 = 0.03 \text{ [s]}$$

$$T2 = \frac{L - 0.5 \cdot V \cdot (T1 + T3)}{V} = \frac{200 - 0.5 \cdot 300 \cdot (0.03 + 0.03)}{300} = 0.64 \text{ [s]}$$

$$T4 = 0.15 \text{ [s]}$$

The **cycle time** can be found as follows.

$$T = T1 + T2 + T3 + T4 = 0.03 + 0.64 + 0.03 + 0.15 = 0.85 \text{ [s]}$$

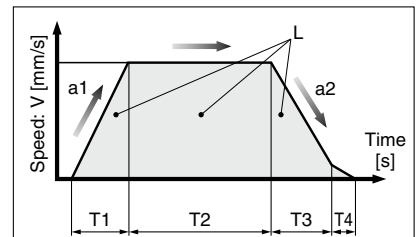

- L : Stroke [mm] ... (Operating condition)
- V : Speed [mm/s] ... (Operating condition)
- a1: Acceleration [mm/s<sup>2</sup>] ... (Operating condition)
- a2: Deceleration [mm/s<sup>2</sup>] ... (Operating condition)

- T1: Acceleration time [s]  
Time until reaching the set speed
- T2: Constant speed time [s]  
Time while the actuator is operating at a constant speed
- T3: Deceleration time [s]  
Time from the beginning of the constant speed operation to stop
- T4: Settling time [s]  
Time until positioning is completed

**Step 3 Check the allowable moment.** <Static allowable moment> (page 14)  
<Dynamic allowable moment> (pages 15, 16)

Confirm the moment that applies to the actuator is within the allowable range for both static and dynamic conditions.

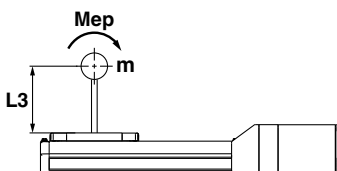

Based on the above calculation result, the **LEKFS25GA-200** should be selected.

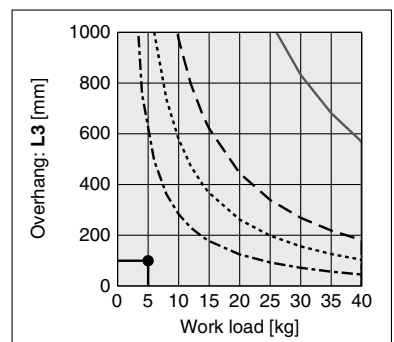

\* If the step motor and servo motors do not meet your specifications, also consider the AC servo specification.

### Speed-Work Load Graph (Guide)

\* The following graphs show the values when the moving force is 100%.

#### LEKFS25GH/Ball Screw Drive

##### Horizontal/Lead 20

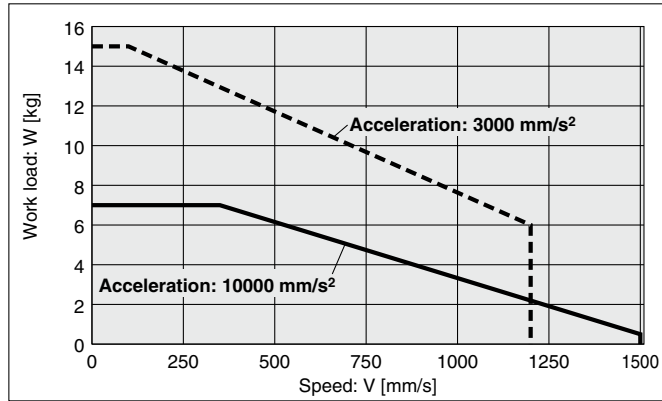

##### Vertical/Lead 20

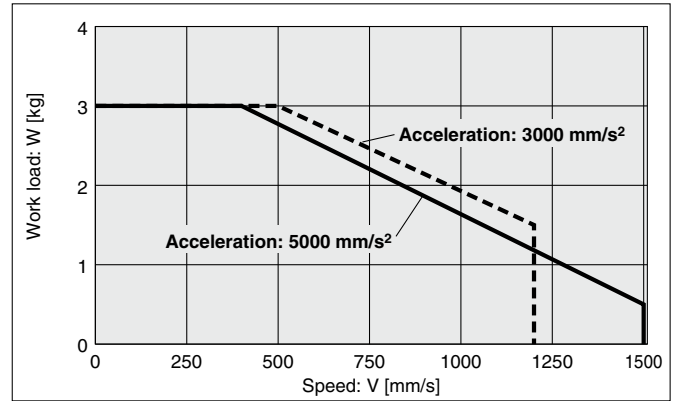

#### LEKFS25GA/Ball Screw Drive

##### Horizontal/Lead 12

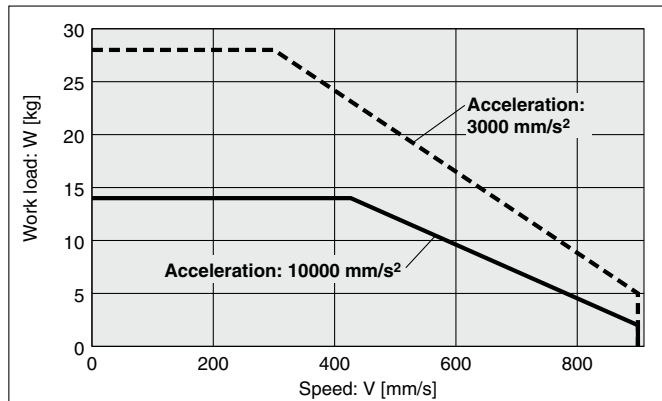

##### Vertical/Lead 12

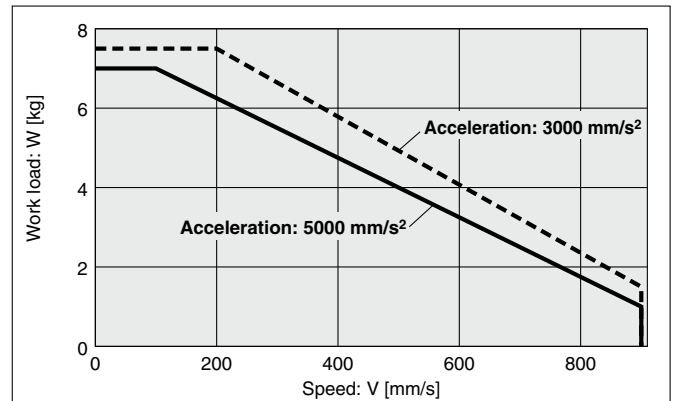

#### LEKFS25GB/Ball Screw Drive

##### Horizontal/Lead 6

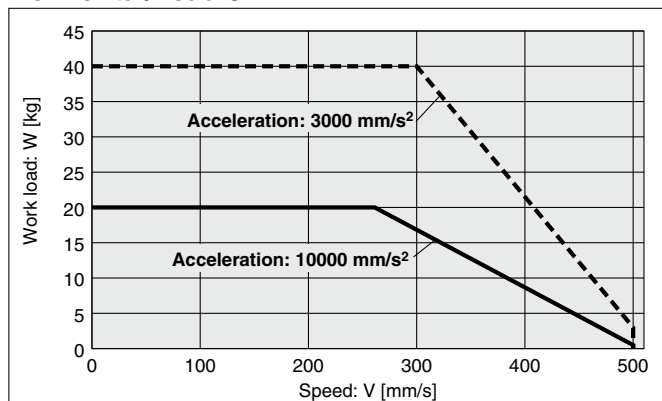

##### Vertical/Lead 6

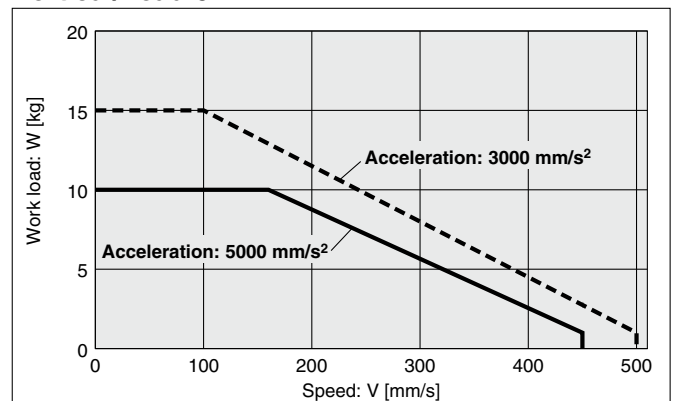

**Operating temperature: Use products with a duty ratio of 100% or less when the temperature is below 30°C and with a duty ratio of 35% or less when the temperature exceeds 30°C.**

Model Selection

LEKFS□G Series

Auto Switch

JXC5H/6H Series

JXCEH/9H/PH Series

## Speed-Work Load Graph (Guide)

\* The following graphs show the values when the moving force is 100%.

### LEKFS32GH/Ball Screw Drive

#### Horizontal/Lead 24

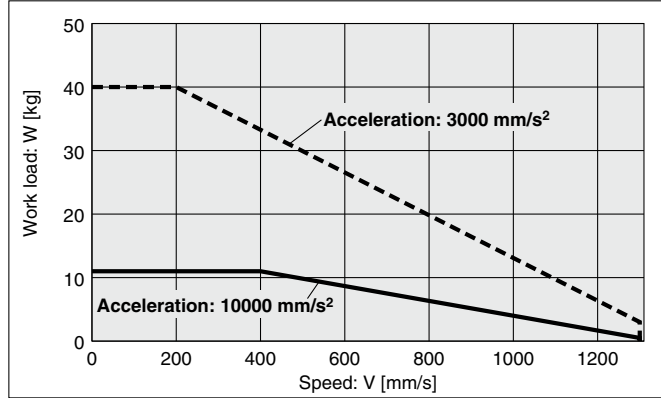

#### Vertical/Lead 24

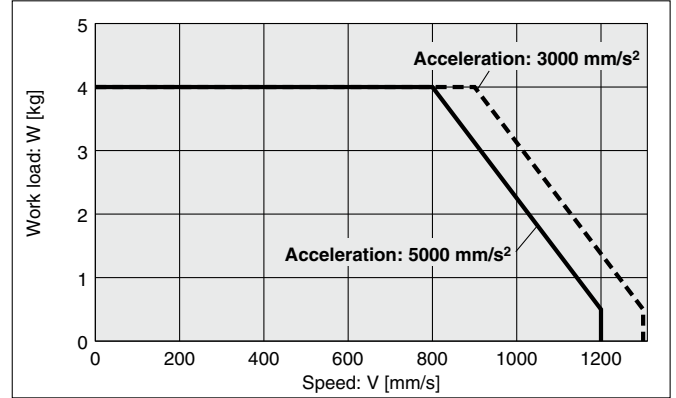

### LEKFS32GA/Ball Screw Drive

#### Horizontal/Lead 16

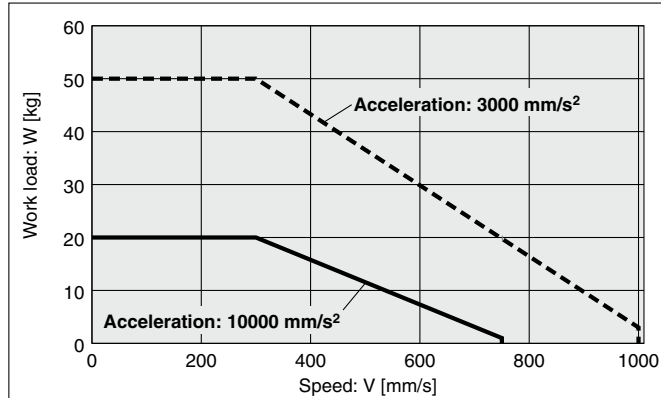

#### Vertical/Lead 16

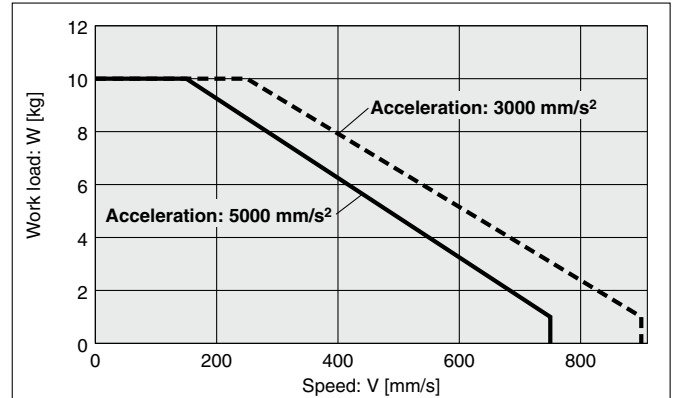

### LEKFS32GB/Ball Screw Drive

#### Horizontal/Lead 8

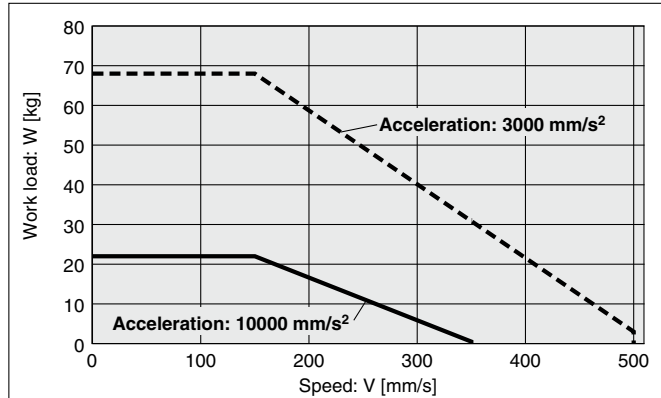

#### Vertical/Lead 8

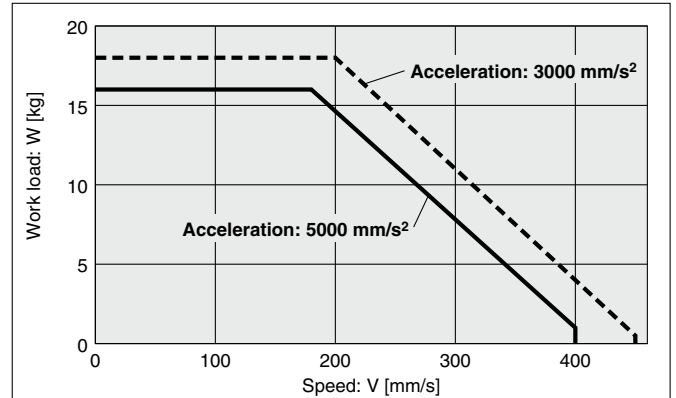

**Operating temperature:** Use products with a duty ratio of 100% or less when the temperature is below 30°C and with a duty ratio of 35% or less when the temperature exceeds 30°C.

### Speed-Work Load Graph (Guide)

\* The following graphs show the values when the moving force is 100%.

#### LEKFS40GH/Ball Screw Drive

##### Horizontal/Lead 30

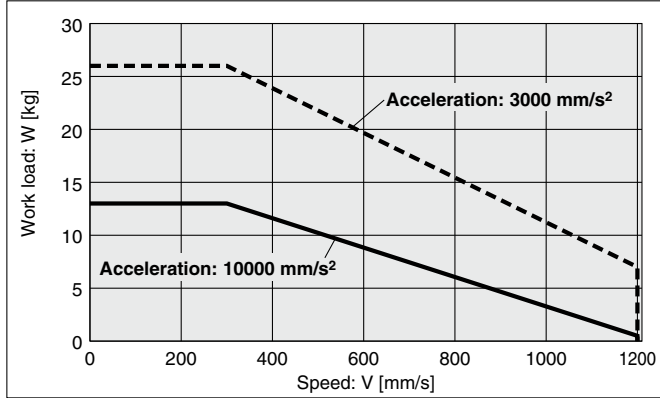

##### Vertical/Lead 30

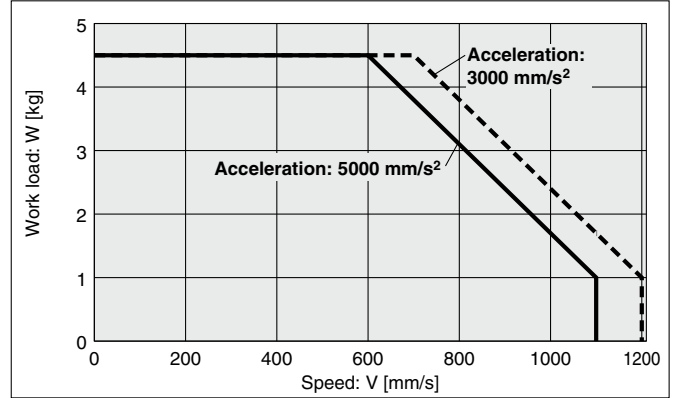

#### LEKFS40GA/Ball Screw Drive

##### Horizontal/Lead 20

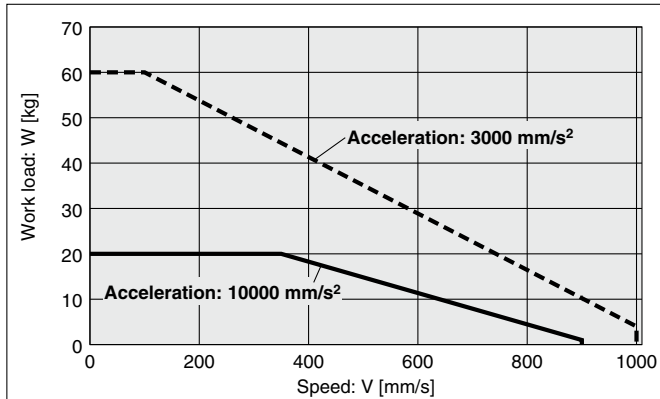

##### Vertical/Lead 20

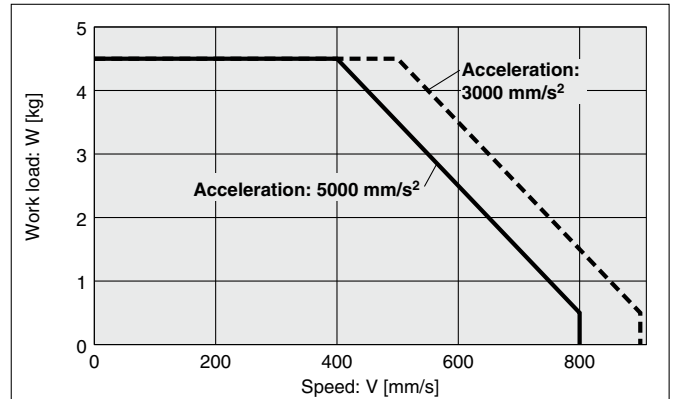

#### LEKFS40GB/Ball Screw Drive

##### Horizontal/Lead 10

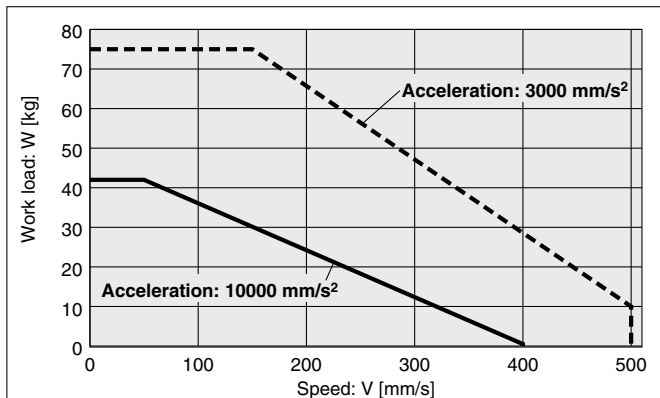

##### Vertical/Lead 10

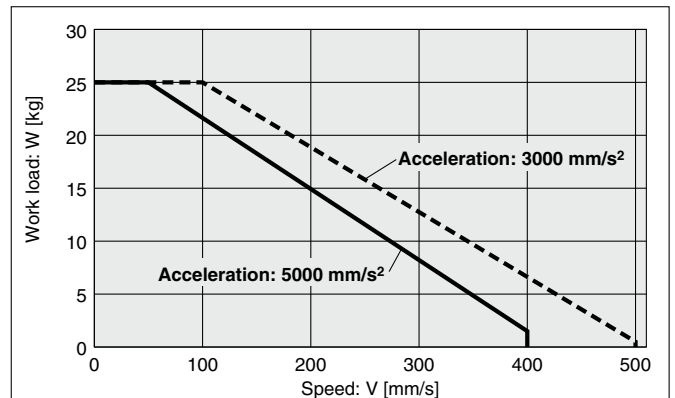

Operating temperature: Use products with a duty ratio of 100% or less when the temperature is below 30°C and with a duty ratio of 35% or less when the temperature exceeds 30°C.

### Static Allowable Moment\*1

Model	LEKFS25	LEKFS32	LEKFS40
Pitching [N·m]	61	141	264
Yawing [N·m]	70	141	264
Rolling [N·m]	115	290	473

\*1 The static allowable moment is the amount of static moment which can be applied to the actuator when it is stopped. If the product is exposed to impact or repeated load, be sure to take adequate safety measures when using the product.

## Dynamic Allowable Moment

\* These graphs show the amount of allowable overhang (guide unit) when the center of gravity of the workpiece overhangs in one direction.

**Acceleration**    ——— 1000 mm/s<sup>2</sup>    - - - 3000 mm/s<sup>2</sup>    ····· 5000 mm/s<sup>2</sup>    - · - · 10000 mm/s<sup>2</sup>

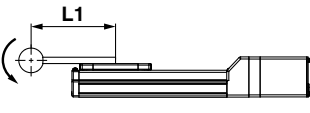
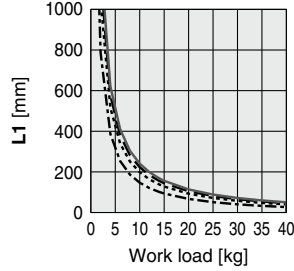
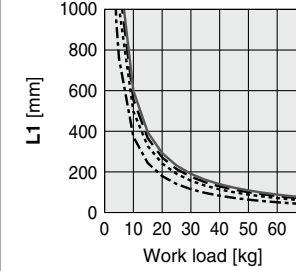
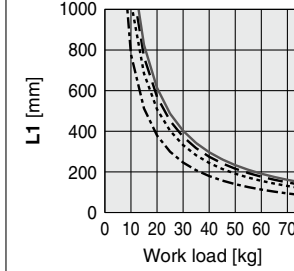
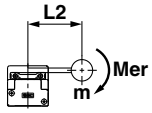
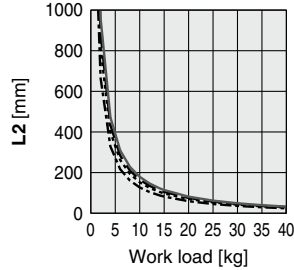
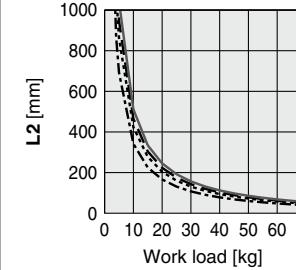
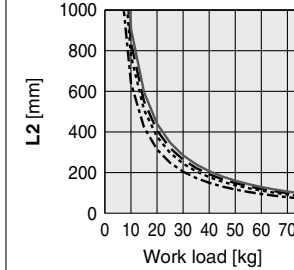
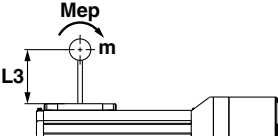
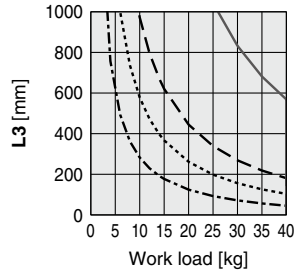
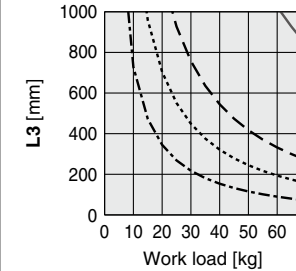
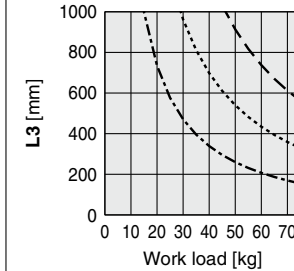
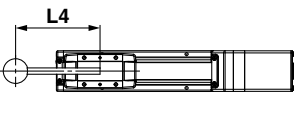
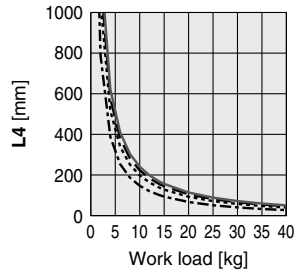
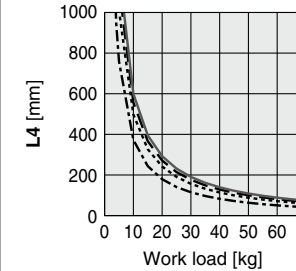
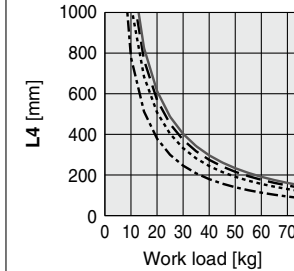
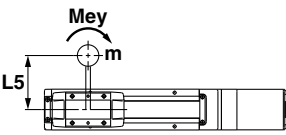
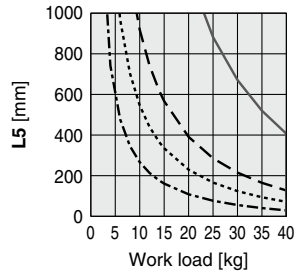
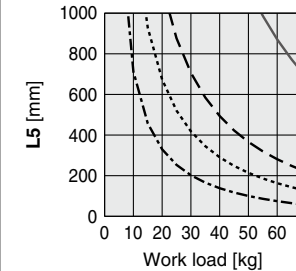
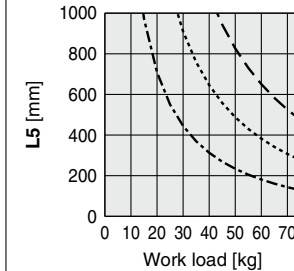
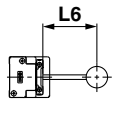
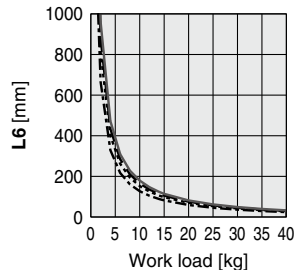
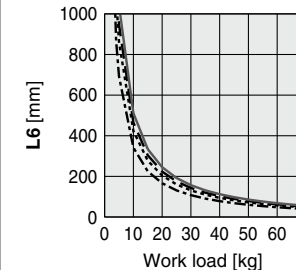
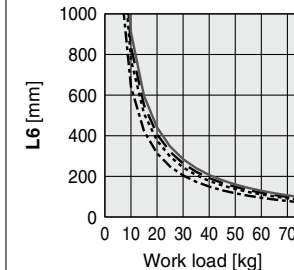
Orientation	Load overhanging direction m : Work load [kg] Me : Allowable moment [N·m] L : Overhang to the work load center of gravity [mm]	Model		
		LEKFS25G	LEKFS32G	LEKFS40G
Horizontal/Bottom	 X			
	 Y			
	 Z			
Wall	 X			
	 Y			
	 Z			



## Dynamic Allowable Moment

\* These graphs show the amount of allowable overhang (guide unit) when the center of gravity of the workpiece overhangs in one direction.

Acceleration    ——— 1000 mm/s<sup>2</sup>    - - - 3000 mm/s<sup>2</sup>    ..... 5000 mm/s<sup>2</sup>

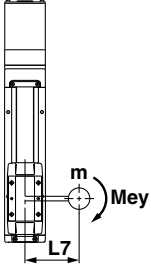
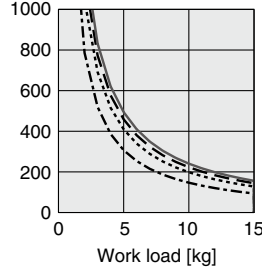
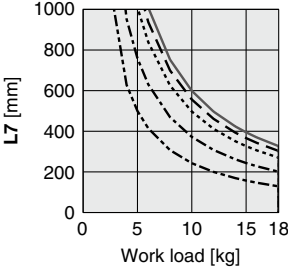
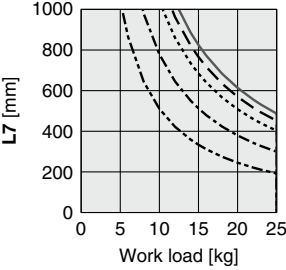
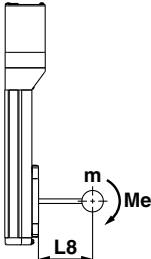
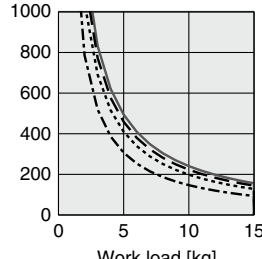
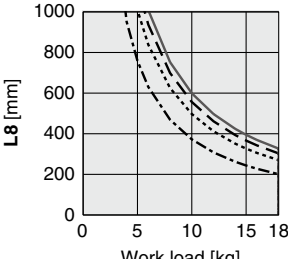
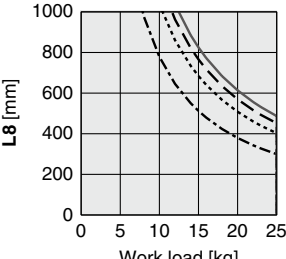
Orientation m : Work load [kg] Me: Allowable moment [N·m] L : Overhang to the work load center of gravity [mm]		Model		
		LEKFS25G	LEKFS32G	LEKFS40G
Vertical	Y 			
	Z 			

## Calculation of Guide Load Factor

- Decide operating conditions.

Model: LEKFS□G

Size: 25/32/40

Mounting orientation: Horizontal/Bottom/Wall/Vertical

Acceleration [mm/s<sup>2</sup>]: a

Work load [kg]: m

Work load center position [mm]: Xc/Yc/Zc

- Select the target graph while referencing the model, size, and mounting orientation.

- Based on the acceleration and work load, find the overhang [mm]: Lx/Ly/Lz from the graph.

- Calculate the load factor for each direction.

$$\alpha_x = X_c/L_x, \alpha_y = Y_c/L_y, \alpha_z = Z_c/L_z$$

- Confirm the total of  $\alpha_x$ ,  $\alpha_y$ , and  $\alpha_z$  is 1 or less.

$$\alpha_x + \alpha_y + \alpha_z \leq 1$$

When 1 is exceeded, please consider a reduction of acceleration and work load, or a change of the work load center position and series.

### Mounting orientation

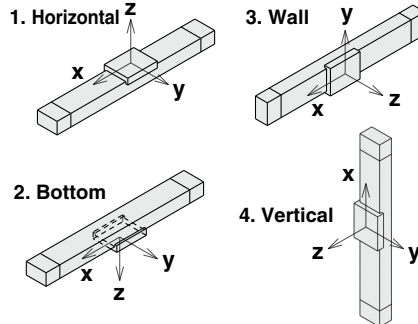

### Example

- Operating conditions

Model: LEKFS40G

Size: 40

Mounting orientation: Horizontal

Acceleration [mm/s<sup>2</sup>]: 10000

Work load [kg]: 20

Work load center position [mm]: Xc = 0, Yc = 50, Zc = 200

- Select the graphs for horizontal of the LEKFS40G on page 15.

- Lx = 380 mm, Ly = 320 mm, Lz = 740 mm

- The load factor for each direction can be found as follows.

$$\alpha_x = 0/380 = 0$$

$$\alpha_y = 50/320 = 0.156$$

$$\alpha_z = 200/740 = 0.270$$

- $\alpha_x + \alpha_y + \alpha_z = 0.426 \leq 1$

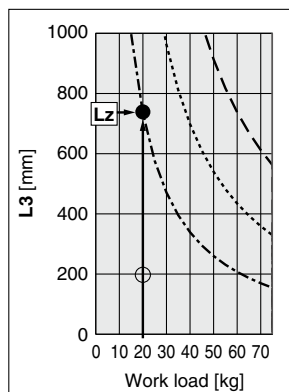
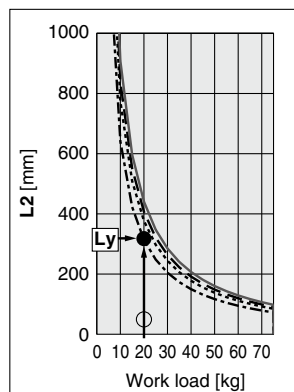
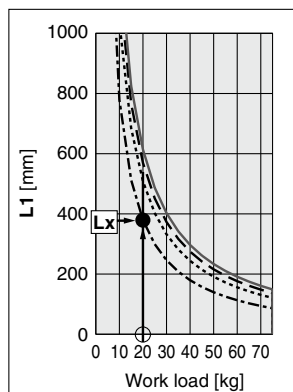

## Table Accuracy (Reference Value)

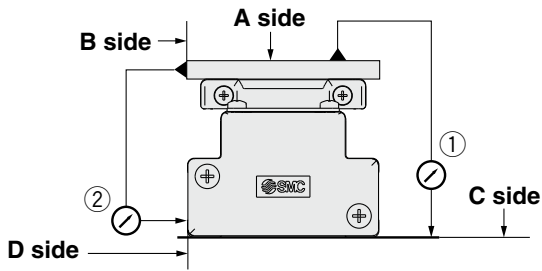

Model	Traveling parallelism [mm] (Every 300 mm)	
	① C side traveling parallelism to A side	② D side traveling parallelism to B side
<b>LEKFS25</b>	0.04	0.02
<b>LEKFS32</b>	0.04	0.02
<b>LEKFS40</b>	0.04	0.02

\* Traveling parallelism does not include the mounting surface accuracy.

## Table Displacement (Reference Value)

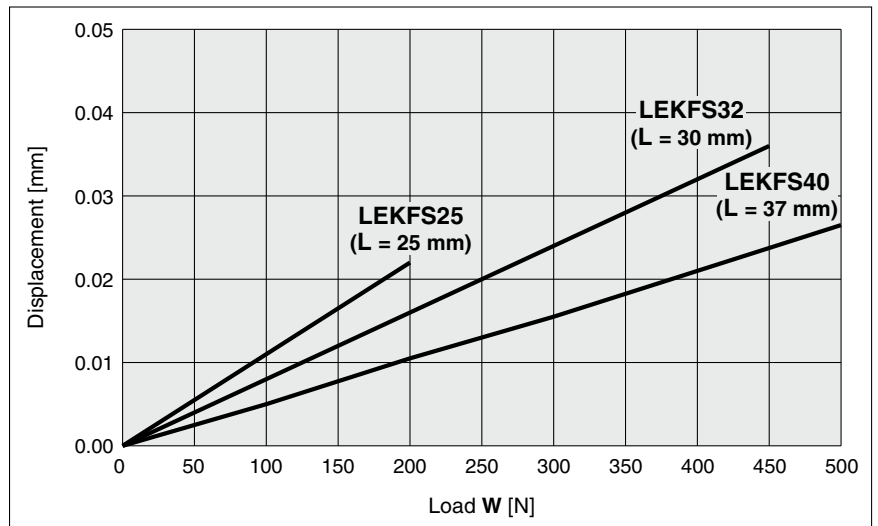
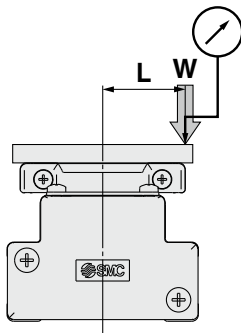

\* This displacement is measured when a 15 mm aluminum plate is mounted and fixed on the table.

Battery-less Absolute (Step Motor 24 VDC)

## High Performance

# High Rigidity and High Precision Slider Type LEKFS□G Series LEKFS25, 32, 40

CE UK CA  
\* For details, refer to page 45.

RoHS

### How to Order

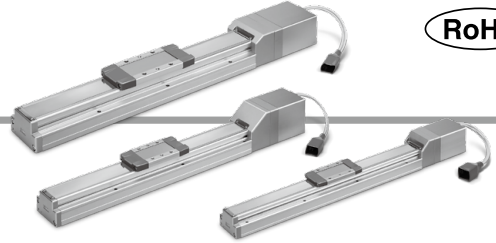

LEKFS **32** **G** **A** - **300** **R1** **C5H73**

① ② ③ ④ ⑤ ⑥ ⑦ ⑧ ⑨

#### ① Size

25
32
40

#### ② Motor mounting position

Nil	In-line
R	Right side parallel
L	Left side parallel

#### ③ Motor type

G	High performance Battery-less absolute (Step motor 24 VDC)
---	--

#### ④ Lead [mm]

Symbol	LEKFS25	LEKFS32	LEKFS40
H	20	24	30
A	12	16	20
B	6	8	10

#### ⑤ Stroke\*1

100	100
to	to
600	600

\* For details, refer to the applicable stroke table below.

#### Applicable Stroke Table

Size	Stroke					
	100	200	300	400	500	600
25	●	●	●	●	●	—
32	●	●	●	●	●	—
40	—	●	●	●	●	●

#### ⑥ Motor option

Nil	Without option
B	With lock

#### ⑦ Grease application (Seal band part)

Nil	With
N	Without (Roller specification)

#### ⑧ Actuator cable type/length

Robotic cable [m]			
Nil	None	R8	8*2
R1	1.5	RA	10*2
R3	3	RB	15*2
R5	5	RC	20*2

Model Selection

LEKFS□G Series

Auto Switch

JXC5H/6H Series

JXCEH/9H/PH Series

For auto switches, refer to pages 27 to 29.

## 9 Controller

Nil	Without controller
C□H□□	With controller



### Controller type

5	Parallel I/O (NPN) type
6	Parallel I/O (PNP) type
E	EtherCAT
9	EtherNet/IP™
P	PROFINET

### Mounting

7	Screw mounting
8*3	DIN rail

### Number of axes/Special specification

H	1 axis/High performance type
---	------------------------------

### I/O cable length

Nil	Without cable
1	1.5 m
3	3 m
5	5 m

- \*1 Please contact SMC for non-standard strokes as they are produced as special orders.
- \*2 Produced upon receipt of order
- \*3 The DIN rail is not included. It must be ordered separately.

### ⚠ Caution

#### [CE/UKCA-compliant products]

EMC compliance was tested by combining the electric actuator LEF series and the controller JXC series.

The EMC depends on the configuration of the customer's control panel and the relationship with other electrical equipment and wiring. Therefore, compliance with the EMC directive cannot be certified for SMC components incorporated into the customer's equipment under actual operating conditions. As a result, it is necessary for the customer to verify compliance with the EMC directive for the machinery and equipment as a whole.

### ■ Trademark

EtherNet/IP® is a registered trademark of ODVA, Inc.  
EtherCAT® is registered trademark and patented technology, licensed by Beckhoff Automation GmbH, Germany.

### The actuator and controller are sold as a package.

Confirm that the combination of the controller and actuator is correct.

#### <Check the following before use.>

- \*1 Check the actuator label for the model number. This number should match that of the controller.

LEKFS25GA-400

\*1

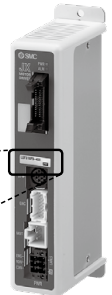

- \* Refer to the Operation Manual for using the products. Please download it via our website:

Type	Step data input type	EtherCAT direct input type	EtherNet/IP™ direct input type	PROFINET direct input type
Series	JXC5H JXC6H	JXCEH	JXC9H	JXCPH
Features	Parallel I/O	EtherCAT direct input	EtherNet/IP™ direct input	PROFINET direct input
Compatible motor	Step motor 24 VDC			
Max. number of step data	64 points			
Power supply voltage	24 VDC			
Reference page	31	38		

## Specifications

Model		LEKFS25			LEKFS32			LEKFS40				
Actuator specifications	Stroke [mm]	100 to 500			100 to 500			200 to 600				
	Work load [kg]*2	Horizontal	15	28	40	40	50	68	26	60	75	
		Vertical	3	7.5	15	4	10	18	4.5	4.5	25	
	Speed [mm/s]	Stroke range	Up to 400	20 to 1500	12 to 900	6 to 500	24 to 1300	16 to 1000	8 to 500	30 to 1200	20 to 1000	10 to 500
			401 to 500	20 to 1100	12 to 750	6 to 400	24 to 1300	16 to 950	8 to 500	30 to 1200	20 to 1000	10 to 500
			501 to 600	—	—	—	—	—	—	30 to 1200	20 to 1000	10 to 500
	Max. acceleration/ deceleration [mm/s <sup>2</sup> ]	Horizontal	10000									
		Vertical	5000									
	Positioning repeatability [mm]		±0.01 (Lead H: ±0.02)									
	Lost motion [mm]*3		0.05 or less									
	Lead [mm]		20	12	6	24	16	8	30	20	10	
	Impact/Vibration resistance [m/s <sup>2</sup> ]*4		50/20									
Actuation type		Ball screw (LEKFS□), Ball screw + Belt (LEKFS□ <sup>R</sup> )										
Guide type		Linear guide										
Operating temperature range [°C]		5 to 40										
Operating humidity range [%RH]		90 or less (No condensation)										
Electric specifications	Motor size	□42			□56.4							
	Motor type	Battery-less absolute (Step motor 24 VDC)										
	Encoder	Battery-less absolute										
	Power supply voltage [V]	24 VDC ±10%										
Lock unit specifications	Power [W]*5 *7	Max. power 126			Max. power 222			Max. power 222				
	Type*6	Non-magnetizing lock										
	Holding force [N]	47	78	157	72	108	216	75	113	245		
	Power [W]*7	5			5			5				
Power supply voltage [V]		24 VDC ±10%										

- \*1 Please contact SMC for non-standard strokes as they are produced as special orders.
- \*2 The max. work load at 3000 mm/s<sup>2</sup> acceleration and deceleration speed  
 Work load varies depending on the speed and acceleration. Check the "Speed-Work Load Graph" on pages 12 to 14.  
 Furthermore, if the cable length exceeds 5 m, the speed and work load specified in the "Speed-Work Load Graph" may decrease by up to 10% for each 5 m increase.
- \*3 A reference value for correcting errors in reciprocal operation
- \*4 Impact resistance: No malfunction occurred when the actuator was tested with a drop tester in both an axial direction and a perpendicular direction to the lead screw. (The test was performed with the actuator in the initial state.)  
 Vibration resistance: No malfunction occurred in a test ranging between 45 to 2000 Hz. The test was performed in both an axial direction and a perpendicular direction to the lead screw. (The test was performed with the actuator in the initial state.)
- \*5 Indicates the max. power during operation (including the controller)  
 This value can be used for the selection of the power supply.
- \*6 With lock only
- \*7 For an actuator with lock, add the power for the lock.

## Weight

Series	LEKFS25				
Stroke [mm]	100	200	300	400	500
Product weight [kg]	1.8	2.1	2.4	2.6	2.9
Additional weight with lock [kg]	0.26				

Series	LEKFS32				
Stroke [mm]	100	200	300	400	500
Product weight [kg]	3.4	3.8	4.3	4.7	5.1
Additional weight with lock [kg]	0.53				

Series	LEKFS40				
Stroke [mm]	200	300	400	500	600
Product weight [kg]	5.8	6.4	7.0	7.6	8.2
Additional weight with lock [kg]	0.53				

## Dimensions: In-line Motor

### LEKFS25G

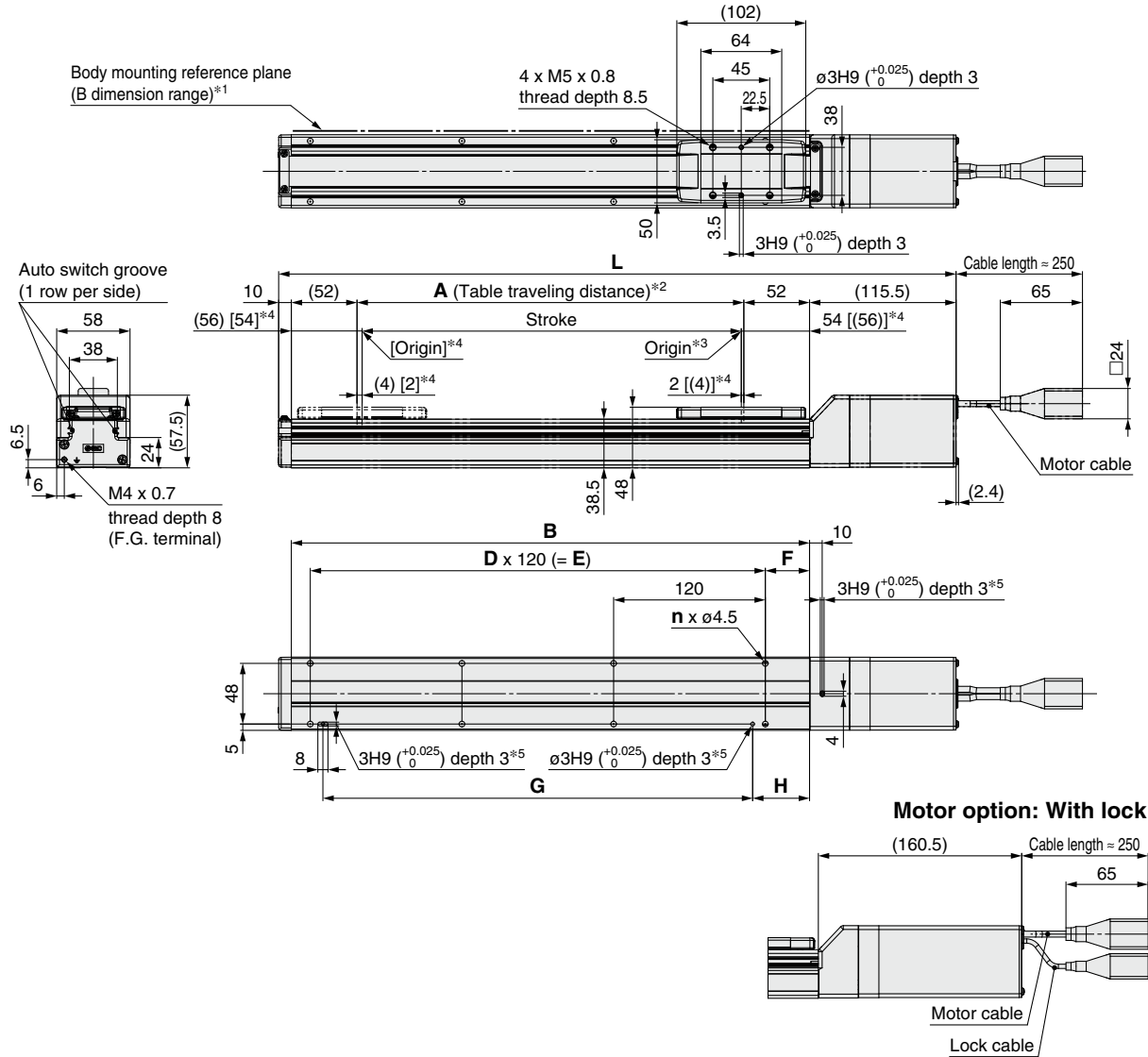

- \*1 When mounting the actuator using the body mounting reference plane, set the height of the opposite surface or pin to be 3 mm or more. (Recommended height: 5 mm)  
In addition, be aware that surfaces other than the body mounting reference plane (B dimension range) may slightly protrude from the body mounting reference plane. Be sure to provide a clearance of 1 mm or more to avoid interference with workpieces, facilities, etc.
- \*2 This is the distance within which the table can move when it returns to origin. Make sure that workpieces mounted on the table do not interfere with other workpieces or the facilities around the table.
- \*3 Position after returning to origin
- \*4 [ ] for when the direction of return to origin has changed
- \*5 When using the positioning pin holes on the bottom, use either the one on the body side or the one on the housing side.

### Dimensions

[mm]

Model	L		A	B	n	D	E	F	G	H
	Without lock	With lock								
LEKFS25G□-100□	335.5	380.5	106	210	4	—	—	35	100	45
LEKFS25G□-200□	435.5	480.5	206	310	6	2	240		220	
LEKFS25G□-300□	535.5	580.5	306	410	8	3	360		340	
LEKFS25G□-400□	635.5	680.5	406	510	8	3	360		340	
LEKFS25G□-500□	735.5	780.5	506	610	10	4	480		460	

## Dimensions: In-line Motor

### LEKFS32G

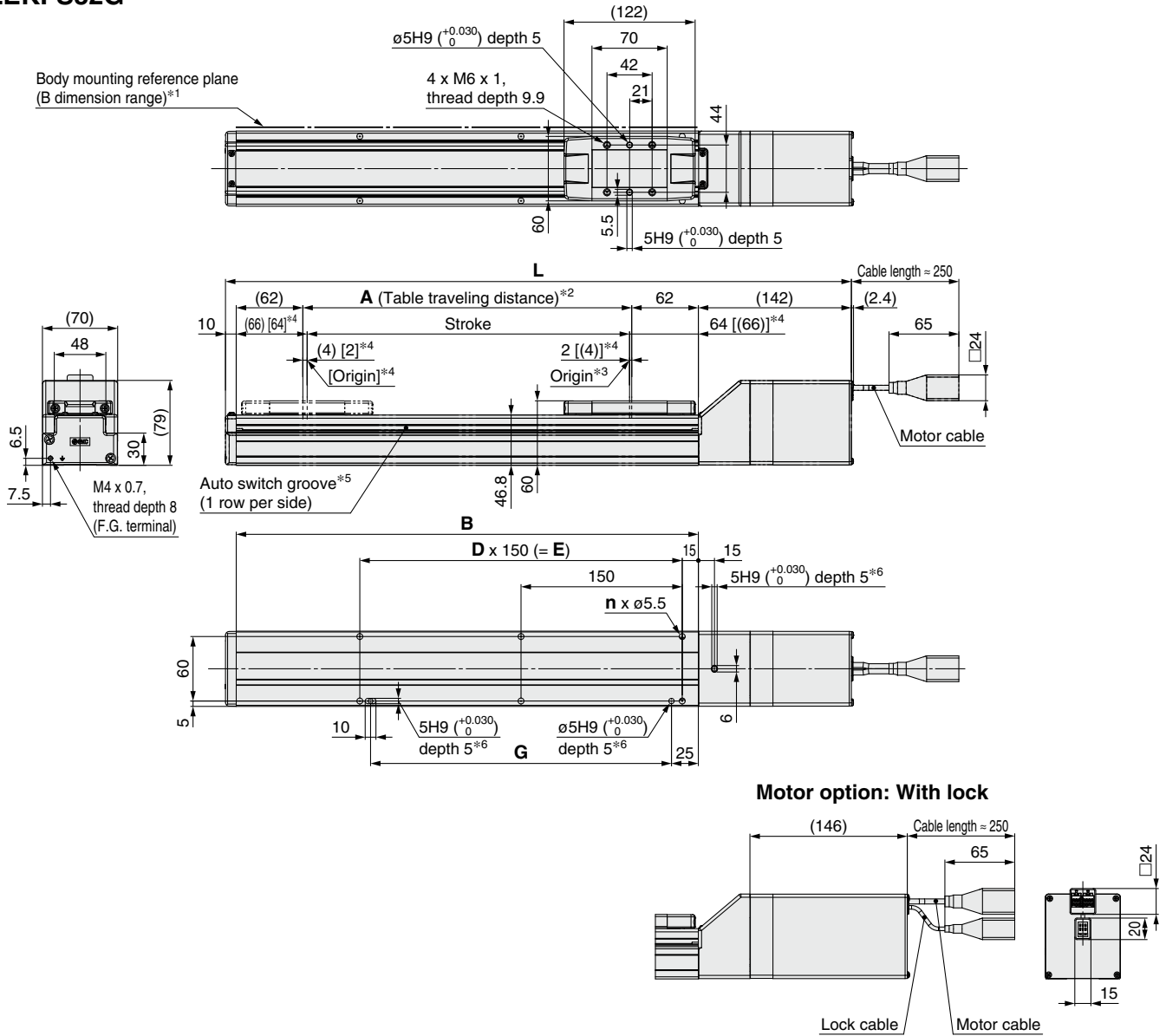

- \*1 When mounting the actuator using the body mounting reference plane, set the height of the opposite surface or pin to be 3 mm or more. (Recommended height: 5 mm)  
In addition, be aware that surfaces other than the body mounting reference plane (B dimension range) may slightly protrude from the body mounting reference plane. Be sure to provide a clearance of 1 mm or more to avoid interference with workpieces, facilities, etc.
- \*2 This is the distance within which the table can move when it returns to origin. Make sure that workpieces mounted on the table do not interfere with other workpieces or the facilities around the table.
- \*3 Position after returning to origin
- \*4 [ ] for when the direction of return to origin has changed
- \*5 A switch spacer (BM3-016) is required to secure auto switches. Please order it separately.
- \*6 When using the positioning pin holes on the bottom, use either the one on the body side or the one on the housing side.

### Dimensions

Model	L		A	B	n	D	E	G
	Without lock	With lock						
LEKFS32G□-100□	404	453	106	230	4	—	—	130
LEKFS32G□-200□	504	553	206	330	6	2	300	280
LEKFS32G□-300□	604	653	306	430	6	2	300	280
LEKFS32G□-400□	704	753	406	530	8	3	450	430
LEKFS32G□-500□	804	853	506	630	10	4	600	580

Model Selection

LEKFS□G Series

Auto Switch

JXC5H/6H Series

JXCEH/9H/PH Series

## Dimensions: In-line Motor

### LEKFS40G

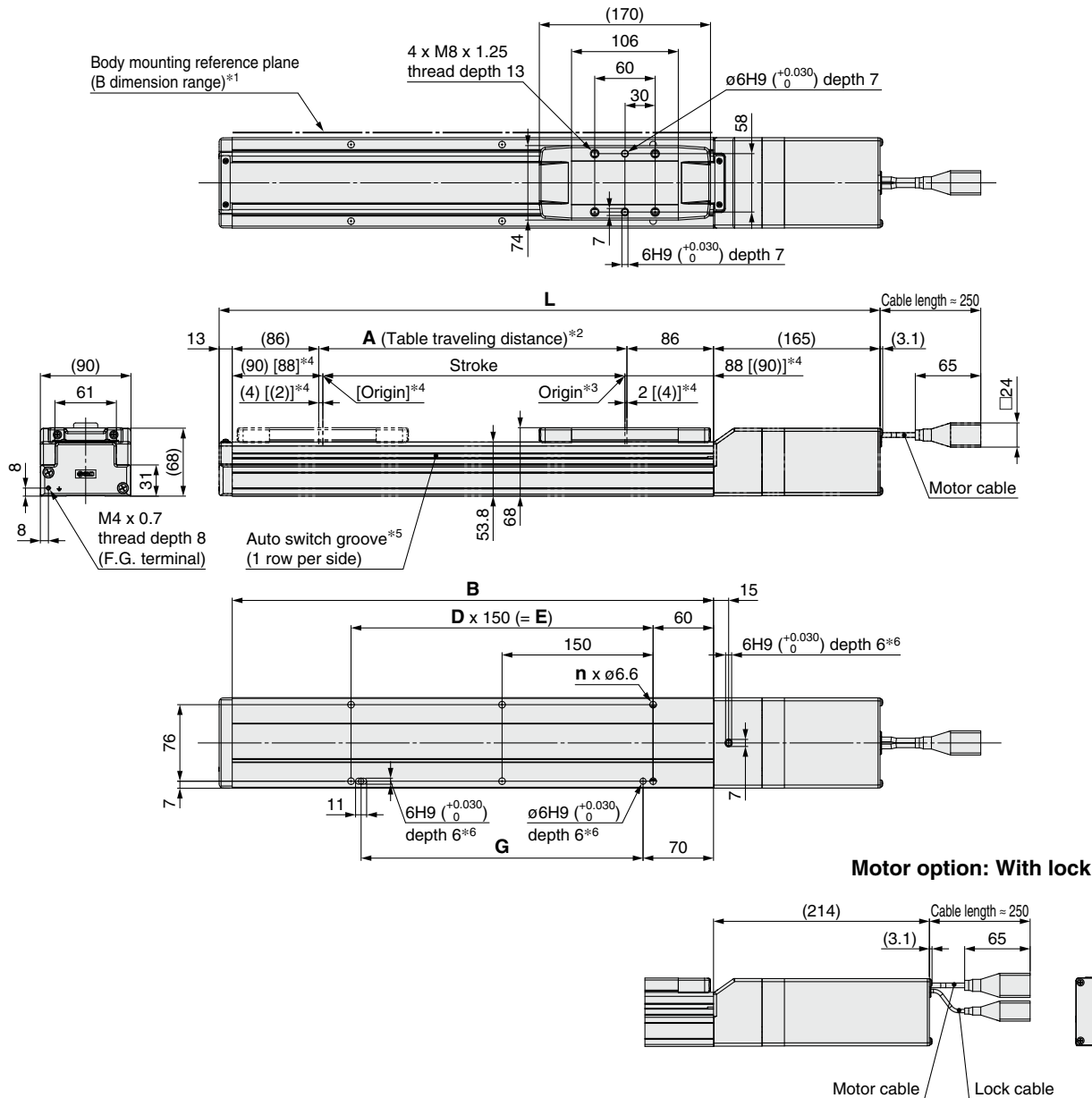

- \*1 When mounting the actuator using the body mounting reference plane, set the height of the opposite surface or pin to be 3 mm or more. (Recommended height: 5 mm)  
In addition, be aware that surfaces other than the body mounting reference plane (B dimension range) may slightly protrude from the body mounting reference plane. Be sure to provide a clearance of 1 mm or more to avoid interference with workpieces, facilities, etc.
- \*2 This is the distance within which the table can move when it returns to origin. Make sure that workpieces mounted on the table do not interfere with other workpieces or the facilities around the table.
- \*3 Position after returning to origin
- \*4 [ ] for when the direction of return to origin has changed
- \*5 A switch spacer (BM Y3-016) is required to secure auto switches. Please order it separately.
- \*6 When using the positioning pin holes on the bottom, use either the one on the body side or the one on the housing side.

### Dimensions

Model	L		A	B	n	D	E	G
	Without lock	With lock						
LEKFS40G□-200□	556	605	206	378	6	2	300	280
LEKFS40G□-300□	656	705	306	478	6	2	300	280
LEKFS40G□-400□	756	805	406	578	8	3	450	430
LEKFS40G□-500□	856	905	506	678	10	4	600	580
LEKFS40G□-600□	956	1005	606	778	10	4	600	580



## Dimensions: Right/Left Side Parallel Motor

### LEKFS25RG

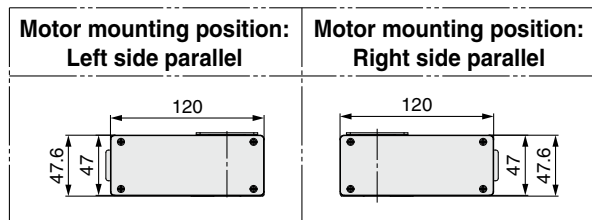
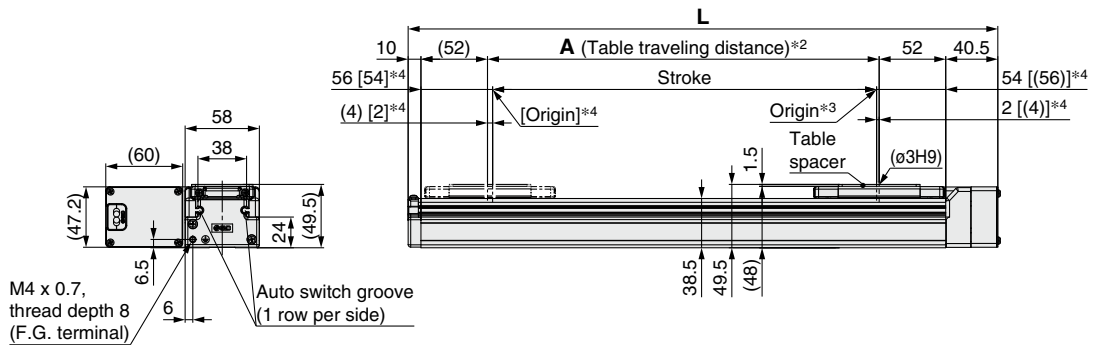
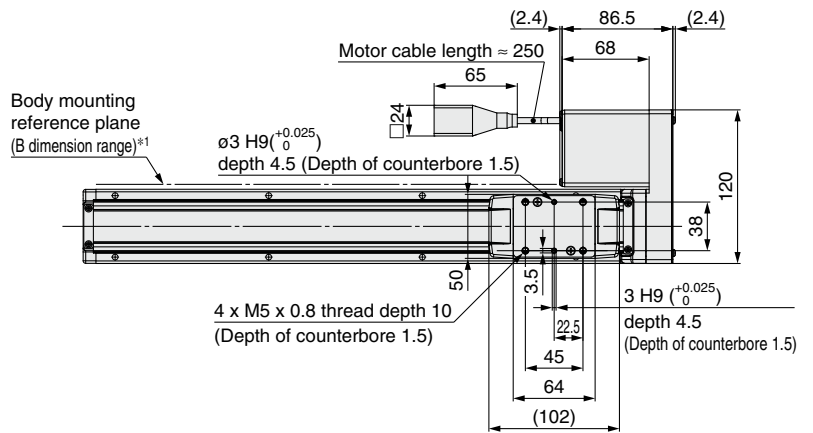
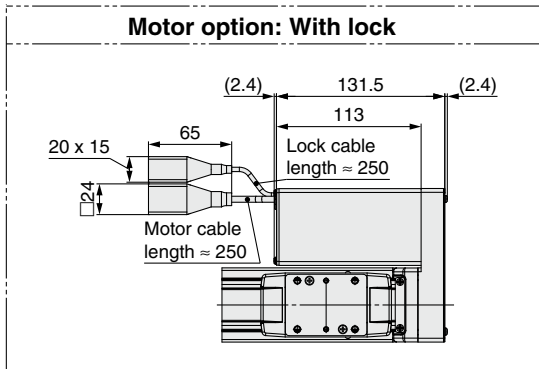

- \*1 When mounting the actuator using the body mounting reference plane, set the height of the opposite surface or pin to be 3 mm or more. (Recommended height: 5 mm)  
 In addition, be aware that surfaces other than the body mounting reference plane (B dimension range) may slightly protrude from the body mounting reference plane. Be sure to provide a clearance of 1 mm or more to avoid interference with workpieces, facilities, etc.
- \*2 This is the distance within which the table can move when it returns to origin. Make sure that workpieces mounted on the table do not interfere with other workpieces or the facilities around the table.
- \*3 Position after returning to origin
- \*4 [ ] for when the direction of return to origin has changed
- \*5 When using the positioning pin holes on the bottom, use either the one on the body side or the one on the housing side.
- \* This illustration shows the motor mounting position for the right side parallel type.

### Dimensions

Model	L	A	B	n	D	E	F	G	H
LEKFS25□G□-100□	260.5	106	210	4	—	—		100	45
LEKFS25□G□-200□	360.5	206	310	6	2	240		220	
LEKFS25□G□-300□	460.5	306	410	8	3	360	35	340	
LEKFS25□G□-400□	560.5	406	510	8	3	360		340	
LEKFS25□G□-500□	660.5	506	610	10	4	480		460	

Model Selection

LEKFS□G Series

Auto Switch

JXC5H/6H Series

JXCEH/9H/PH Series

## Dimensions: Right/Left Side Parallel Motor

### LEKFS32RG

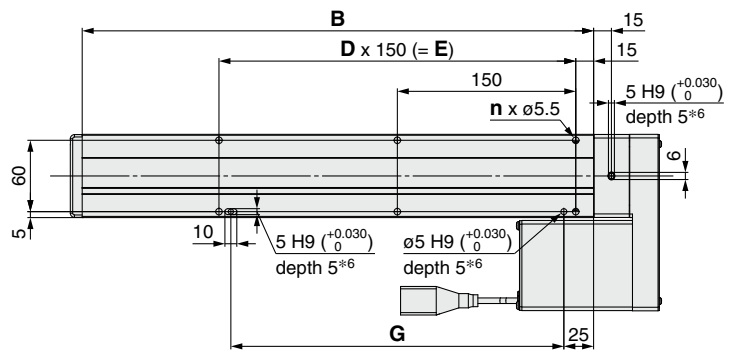
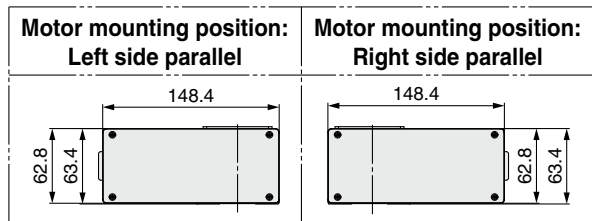
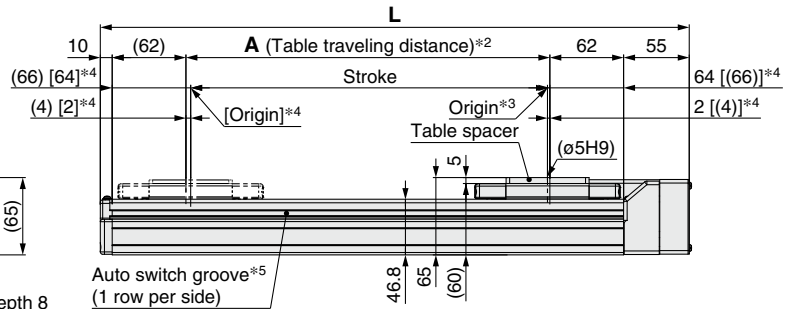
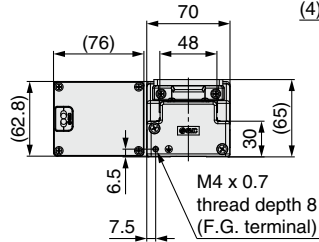
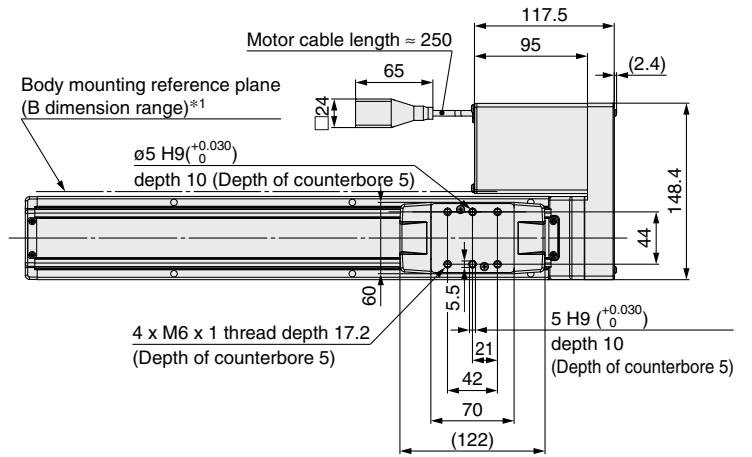
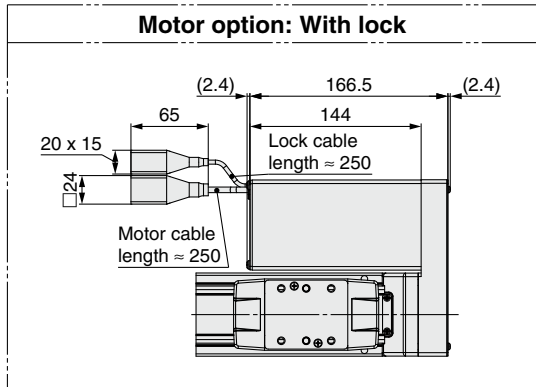

- \*1 When mounting the actuator using the body mounting reference plane, set the height of the opposite surface or pin to be 3 mm or more. (Recommended height: 5 mm) In addition, be aware that surfaces other than the body mounting reference plane (B dimension range) may slightly protrude from the body mounting reference plane. Be sure to provide a clearance of 1 mm or more to avoid interference with workpieces, facilities, etc.
- \*2 This is the distance within which the table can move when it returns to origin. Make sure that workpieces mounted on the table do not interfere with other workpieces or the facilities around the table.
- \*3 Position after returning to origin
- \*4 [ ] for when the direction of return to origin has changed
- \*5 A switch spacer (BM3-016) is required to secure auto switches. Please order it separately.
- \*6 When using the positioning pin holes on the bottom, use either the one on the body side or the one on the housing side.
- \* This illustration shows the motor mounting position for the right side parallel type.

### Dimensions

Model	L	A	B	n	D	E	G
LEKFS32□G□-100□	295	106	230	4	—	—	130
LEKFS32□G□-200□	395	206	330	6	2	300	280
LEKFS32□G□-300□	495	306	430	6	2	300	280
LEKFS32□G□-400□	595	406	530	8	3	450	430
LEKFS32□G□-500□	695	506	630	10	4	600	580

## Dimensions: Right/Left Side Parallel Motor

### LEKFS40RG

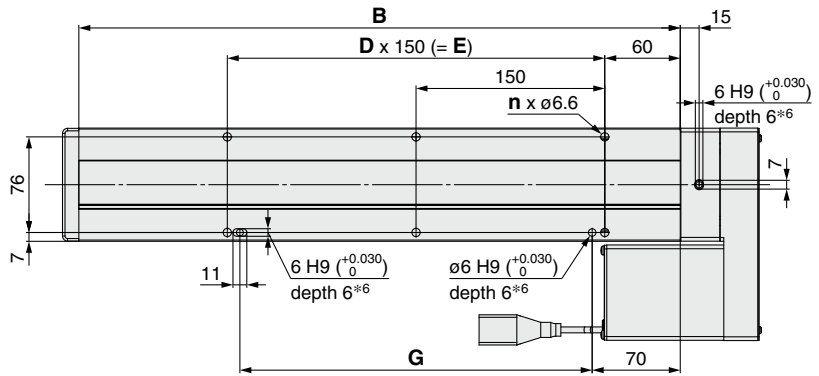
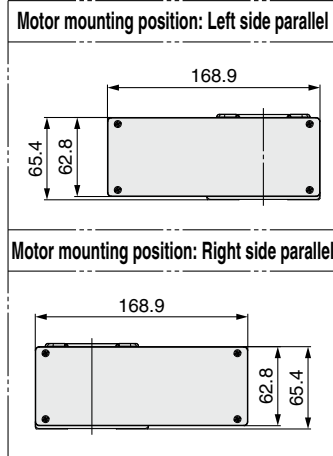
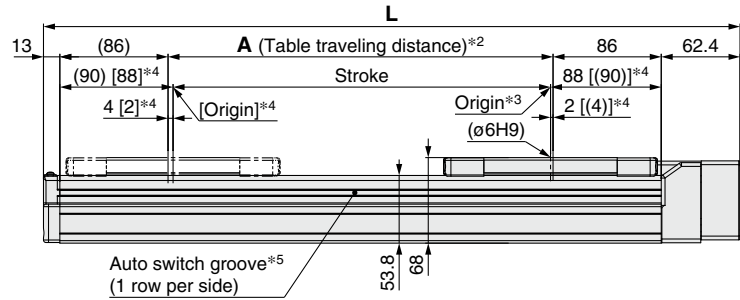
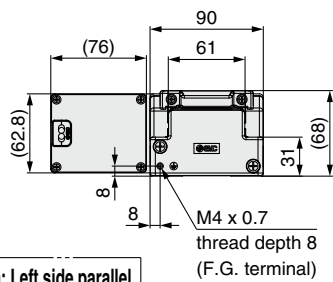
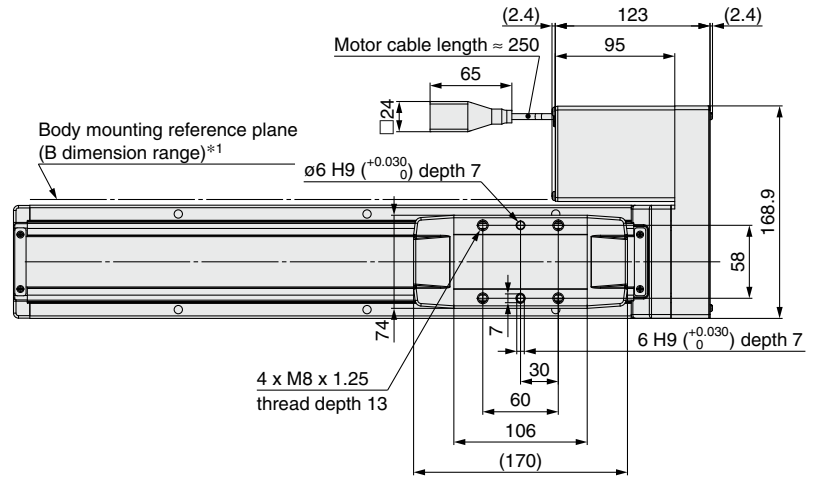
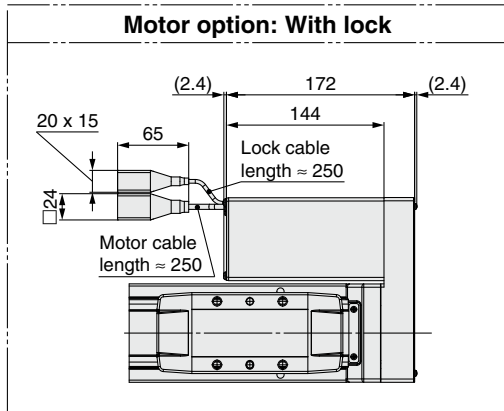

- \*1 When mounting the actuator using the body mounting reference plane, set the height of the opposite surface or pin to be 3 mm or more. (Recommended height: 5 mm)  
In addition, be aware that surfaces other than the body mounting reference plane (B dimension range) may slightly protrude from the body mounting reference plane. Be sure to provide a clearance of 1 mm or more to avoid interference with workpieces, facilities, etc.
- \*2 This is the distance within which the table can move when it returns to origin. Make sure that workpieces mounted on the table do not interfere with other workpieces or the facilities around the table.
- \*3 Position after returning to origin
- \*4 [ ] for when the direction of return to origin has changed
- \*5 A switch spacer (BMY3-016) is required to secure auto switches. Please order it separately.
- \*6 When using the positioning pin holes on the bottom, use either the one on the body side or the one on the housing side.
- \* This illustration shows the motor mounting position for the right side parallel type.

#### Dimensions

Model	L	A	B	n	D	E	G
LEKFS40□G□-200□	453.4	206	378	6	2	300	280
LEKFS40□G□-300□	553.4	306	478	6	2	300	280
LEKFS40□G□-400□	653.4	406	578	8	3	450	430
LEKFS40□G□-500□	753.4	506	678	10	4	600	580
LEKFS40□G□-600□	853.4	606	778	10	4	600	580

# LEKFS□G Series Auto Switch Mounting

## Auto Switch Mounting Position

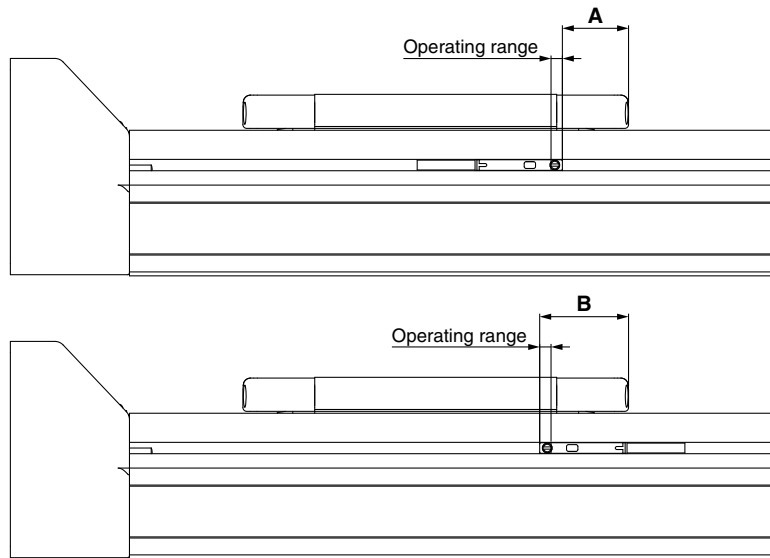

**Table 1 Auto switch mounting dimensions** [mm]

Model	Size	A	B	Operating range
LEKFS□G	25	17.5	23.5	3.0
	32	26.3	32.3	3.4
	40	32.2	38.2	3.6

- \* The applicable auto switch is D-M9 (N/P/B) (W) (M/L/Z).
- \* The operating range is a guideline including hysteresis, not meant to be guaranteed. There may be large variations depending on the ambient environment.
- \* Adjust the auto switch after confirming the operating conditions in the actual setting.

## Auto Switch Mounting

### LEKFS25G

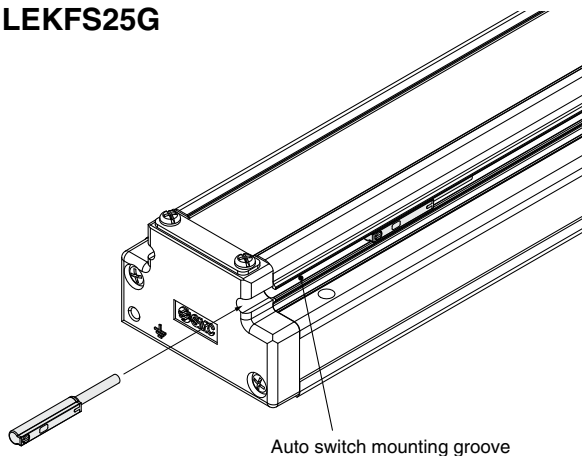

Auto switch mounting groove

### LEKFS32G/40G

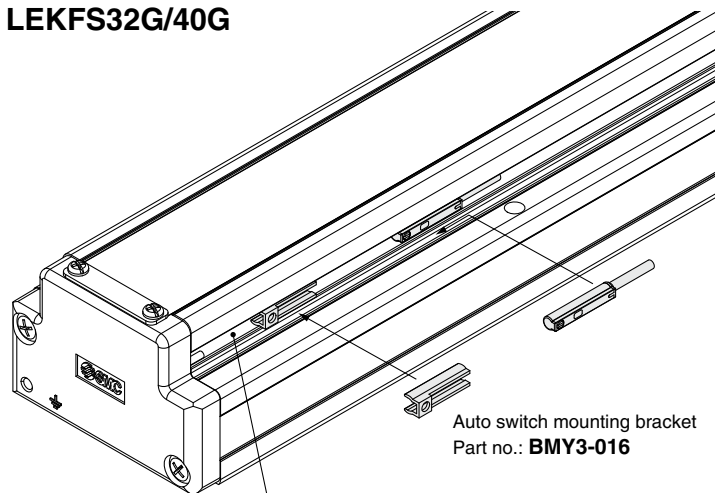

Auto switch mounting groove

Auto switch mounting bracket  
Part no.: **BMY3-016**

Auto Switch Mounting Screw

Tightening torque [N·m]
0.1 to 0.15

- \* The applicable auto switch is D-M9 (N/P/B) (W) (M/L/Z).
- \* When tightening the auto switch mounting screw (included with the auto switch), use a watchmaker's screwdriver with a handle diameter of 5 to 6 mm.
- \* Prepare an auto switch mounting bracket (BMY3-016) when mounting the auto switch on to the LEKFS32G/40G.

# Normally Closed Solid State Auto Switch Direct Mounting Type

## D-M9NE(V)/D-M9PE(V)/D-M9BE(V)



Refer to the SMC website for details on products that are compliant with international standards.

### Grommet

- Output signal turns on when no magnetic force is detected.
- Can be used for the actuator adopted by the solid state auto switch D-M9 series (excluding special order products)



### Caution

#### Precautions

Fix the auto switch with the existing screw installed on the auto switch body. The auto switch may be damaged if a screw other than the one supplied is used.

### Auto Switch Specifications

PLC: Programmable Logic Controller

D-M9□E, D-M9□EV (With indicator light)						
Auto switch model	D-M9NE	D-M9NEV	D-M9PE	D-M9PEV	D-M9BE	D-M9BEV
Electrical entry direction	In-line	Perpendicular	In-line	Perpendicular	In-line	Perpendicular
Wiring type	3-wire				2-wire	
Output type	NPN		PNP		—	
Applicable load	IC circuit, Relay, PLC				24 VDC relay, PLC	
Power supply voltage	5, 12, 24 VDC (4.5 to 28 V)				—	
Current consumption	10 mA or less				—	
Load voltage	28 VDC or less		—		24 VDC (10 to 28 VDC)	
Load current	40 mA or less				2.5 to 40 mA	
Internal voltage drop	0.8 V or less at 10 mA (2 V or less at 40 mA)				4 V or less	
Leakage current	100 μA or less at 24 VDC				0.8 mA or less	
Indicator light	Red LED illuminates when turned ON.					
Standard	CE marking, RoHS					

### Oilproof Flexible Heavy-duty Lead Wire Specifications

Auto switch model	D-M9NE(V)	D-M9PE(V)	D-M9BE(V)
Sheath	Outside diameter [mm] 2.6		
Insulator	Number of cores 3 cores (Brown/Blue/Black)		2 cores (Brown/Blue)
	Outside diameter [mm] 0.88		
Conductor	Effective area [mm <sup>2</sup> ] 0.15		
	Strand diameter [mm] 0.05		
Min. bending radius [mm] (Reference values) 17			

- \* Refer to the **Web Catalog** for solid state auto switch common specifications.
- \* Refer to the **Web Catalog** for lead wire lengths.

### Weight

Auto switch model	D-M9NE(V)	D-M9PE(V)	D-M9BE(V)
Lead wire length	0.5 m (Nil)	8	7
	1 m (M)*1	14	13
	3 m (L)	41	38
	5 m (Z)*1	68	63

\*1 The 1 m and 5 m options are produced upon receipt of order.

### Dimensions

#### D-M9□E

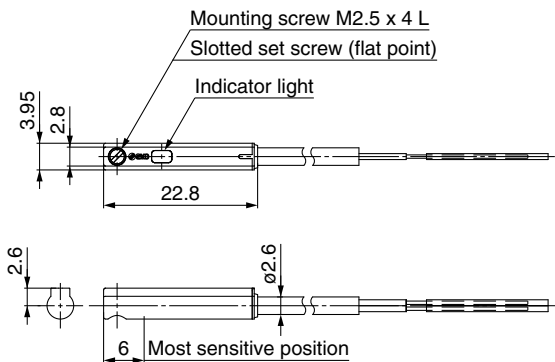

#### D-M9□EV

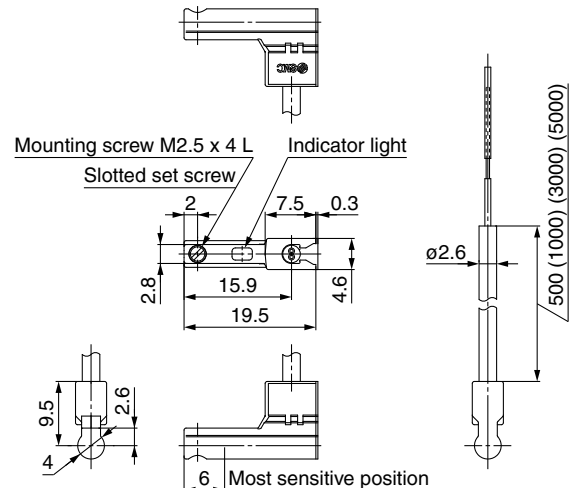

# 2-Color Indicator Solid State Auto Switch Direct Mounting Type

## D-M9NW/D-M9PW/D-M9BW



Refer to the SMC website for details on products that are compliant with international standards.

### Grommet

- 2-wire load current is reduced (2.5 to 40 mA).
- Using flexible cable as standard spec.
- The proper operating range can be determined by the color of the light. (Red → Green ← Red)



### Caution

#### Precautions

Fix the auto switch with the existing screw installed on the auto switch body. The auto switch may be damaged if a screw other than the one supplied is used.

### Auto Switch Specifications

PLC: Programmable Logic Controller

D-M9□W, D-M9□WV (With indicator light)			
Auto switch model	D-M9NW	D-M9PW	D-M9BW
Electrical entry direction	In-line		
Wiring type	3-wire		2-wire
Output type	NPN	PNP	—
Applicable load	IC circuit, Relay, PLC		24 VDC relay, PLC
Power supply voltage	5, 12, 24 VDC (4.5 to 28 V)		—
Current consumption	10 mA or less		
Load voltage	28 VDC or less	—	24 VDC (10 to 28 VDC)
Load current	40 mA or less		2.5 to 40 mA
Internal voltage drop	0.8 V or less at 10 mA (2 V or less at 40 mA)		4 V or less
Leakage current	100 μA or less at 24 VDC		0.8 mA or less
Indicator light	Operating range ..... Red LED illuminates. Proper operating range ..... Green LED illuminates.		
Standard	CE marking, RoHS		

### Oilproof Flexible Heavy-duty Lead Wire Specifications

Auto switch model		D-M9NW	D-M9PW	D-M9BW
Sheath	Outside diameter [mm]	2.6		
Insulator	Number of cores	3 cores (Brown/Blue/Black)		2 cores (Brown/Blue)
	Outside diameter [mm]	0.88		
Conductor	Effective area [mm <sup>2</sup> ]	0.15		
	Strand diameter [mm]	0.05		
Min. bending radius [mm] (Reference values)		17		

- \* Refer to the **Web Catalog** for solid state auto switch common specifications.
- \* Refer to the **Web Catalog** for lead wire lengths.

### Weight

[g]

Auto switch model		D-M9NW	D-M9PW	D-M9BW
Lead wire length	0.5 m (Nil)	8	7	7
	1 m (M)	14	13	13
	3 m (L)	41	38	38
	5 m (Z)	68	63	63

### Dimensions

[mm]

D-M9□W

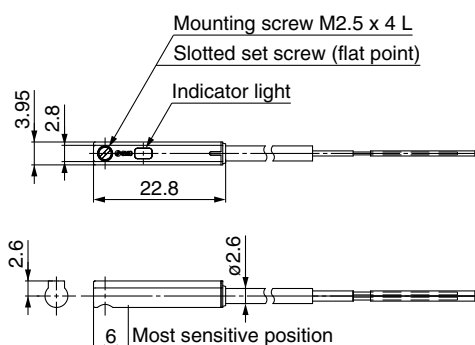

# Controllers

## JXC□ Series



Step Data Input Type ..... p. 31

### High Performance

Battery-less Absolute (Step Motor 24 VDC)

JXC5H/6H Series



EtherCAT/EtherNet/IP™/PROFINET Direct Input Type ..... p. 38

### High Performance

Battery-less Absolute (Step Motor 24 VDC)

JXCEH/9H/PH Series

EtherCAT®

EtherNet/IP™

PROFINET®



• Actuator Cable p. 43

Model Selection

LEKFS□G Series

Auto Switch

JXC5H/6H Series

JXCEH/9H/PH Series

# High Performance Controller (Step Data Input Type)

## JXC5H/6H Series



For details, refer to page 45.



### How to Order

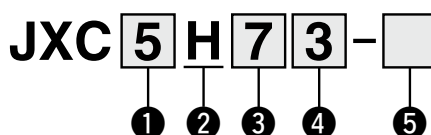

#### 1 Controller type

5	Parallel I/O (NPN) type
6	Parallel I/O (PNP) type

#### 2 Specification

H	1 axis/High performance type
---	------------------------------

#### 3 Mounting

7	Screw mounting
8	DIN rail

#### 4 I/O cable length

Nil	None
1	1.5 m
3	3 m
5	5 m

#### 5 Actuator part number

Without cable specifications and actuator options Example: Enter "LEKFS25GA-400" for the LEKFS25GA-400B-R1C□H□□.	
BC	Blank controller*1

\*1 Requires dedicated software (JXC-BCW)

### The controller is sold as single unit after the compatible actuator is set.

Connect to an actuator (LEKFS□G) designated for a high performance controller. Confirm that the combination of the controller and actuator is correct.

#### <Check the following before use.>

- ① Check the actuator label for the model number. This number should match that of the controller.
- ② Check that the Parallel I/O configuration matches (NPN or PNP).

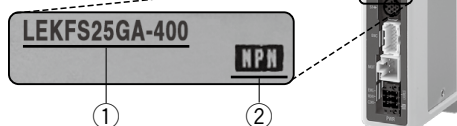

\* Refer to the operation manual for using the products. Please download it via our website:

### Precautions for blank controllers (JXC□1□□-BC)

A blank controller is a controller to which the customer can write the data of the actuator it is to be combined and used with. For data writing, use the controller setting software ACT Controller 2 or the dedicated software JXC-BCW.

- Both ACT Controller 2 and JXC-BCW can be downloaded from the SMC website.
- To use this software, order the communication cable for controller setting (JXC-W2A-C) and the USB cable (LEC-W2-U) separately.

#### Hardware Requirements

OS	Windows®10 (64 bit)	Windows®7
		Windows®8
		Windows®10
Software	ACT Controller 2 (With JXC-BCW function)	JXC-BCW

\* Windows®7, Windows®8, and Windows®10 are registered trademarks of Microsoft Corporation in the United States.

### Specifications

Model	JXC5H JXC6H
<b>Compatible motor</b>	Step motor (Servo/24 VDC)
<b>Power supply</b>	Power supply voltage: 24 VDC ±10%
<b>Current consumption (Controller)</b>	100 mA or less
<b>Compatible encoder</b>	Battery-less absolute
<b>Parallel input</b>	11 inputs (Photo-coupler isolation)
<b>Parallel output</b>	13 outputs (Photo-coupler isolation)
<b>Serial communication</b>	RS485 (Only for the LEC-T1 and JXC-W2)
<b>Memory</b>	EEPROM
<b>LED indicator</b>	PWR, ALM
<b>Cable length [m]</b>	Actuator cable: 20 or less
<b>Cooling system</b>	Natural air cooling
<b>Operating temperature range [°C]</b>	0 to 40
<b>Operating humidity range [%RH]</b>	90 or less (No condensation)
<b>Insulation resistance [MΩ]</b>	Between all external terminals and the case: 50 (500 VDC)
<b>Weight [g]</b>	150 (Screw mounting), 170 (DIN rail mounting)

### ⚠ Caution

#### [CE/UKCA-compliant products]

EMC compliance was tested by combining the electric actuator LE series and the JXC5H/6H series. The EMC depends on the configuration of the customer's control panel and the relationship with other electrical equipment and wiring. Therefore, compliance with the EMC directive cannot be certified for SMC components incorporated into the customer's equipment under actual operating conditions. As a result, it is necessary for the customer to verify compliance with the EMC directive for the machinery and equipment as a whole.



## How to Mount

### a) Screw mounting (JXC□H7□) (Installation with two M4 screws)

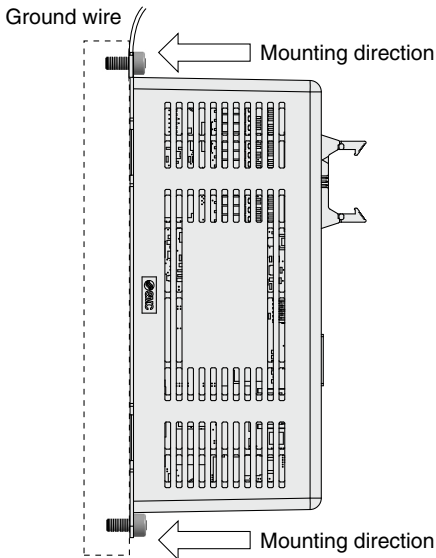

### b) DIN rail mounting (JXC□H8□) (Installation with the DIN rail)

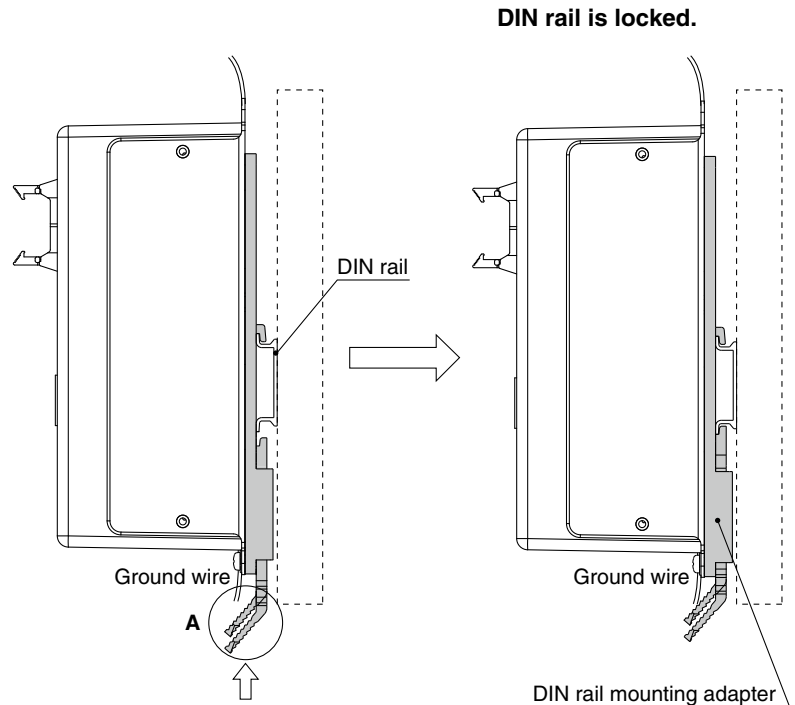

Hook the controller on the DIN rail and press the lever of section **A** in the arrow direction to lock it.

\* When size 25 or more of the LE series are used, the space between the controllers should be 10 mm or more.

### DIN rail AXT100-DR-□

\* For □, enter a number from the No. line in the table below.  
Refer to the dimension drawings on page 33 for the mounting dimensions.

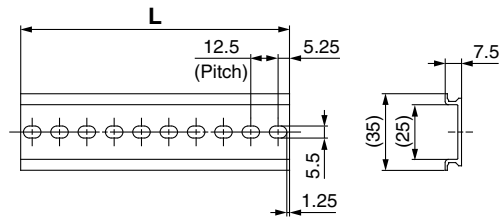

### L Dimensions [mm]

No.	1	2	3	4	5	6	7	8	9	10	11	12	13	14	15	16	17	18	19	20
<b>L</b>	23	35.5	48	60.5	73	85.5	98	110.5	123	135.5	148	160.5	173	185.5	198	210.5	223	235.5	248	260.5
No.	21	22	23	24	25	26	27	28	29	30	31	32	33	34	35	36	37	38	39	40
<b>L</b>	273	285.5	298	310.5	323	335.5	348	360.5	373	385.5	398	410.5	423	435.5	448	460.5	473	485.5	498	510.5

### DIN rail mounting adapter LEC-3-D0 (with 2 mounting screws)

This should be used when the DIN rail mounting adapter is mounted onto a screw mounting type controller afterward.

# JXC5H/6H Series

## Dimensions

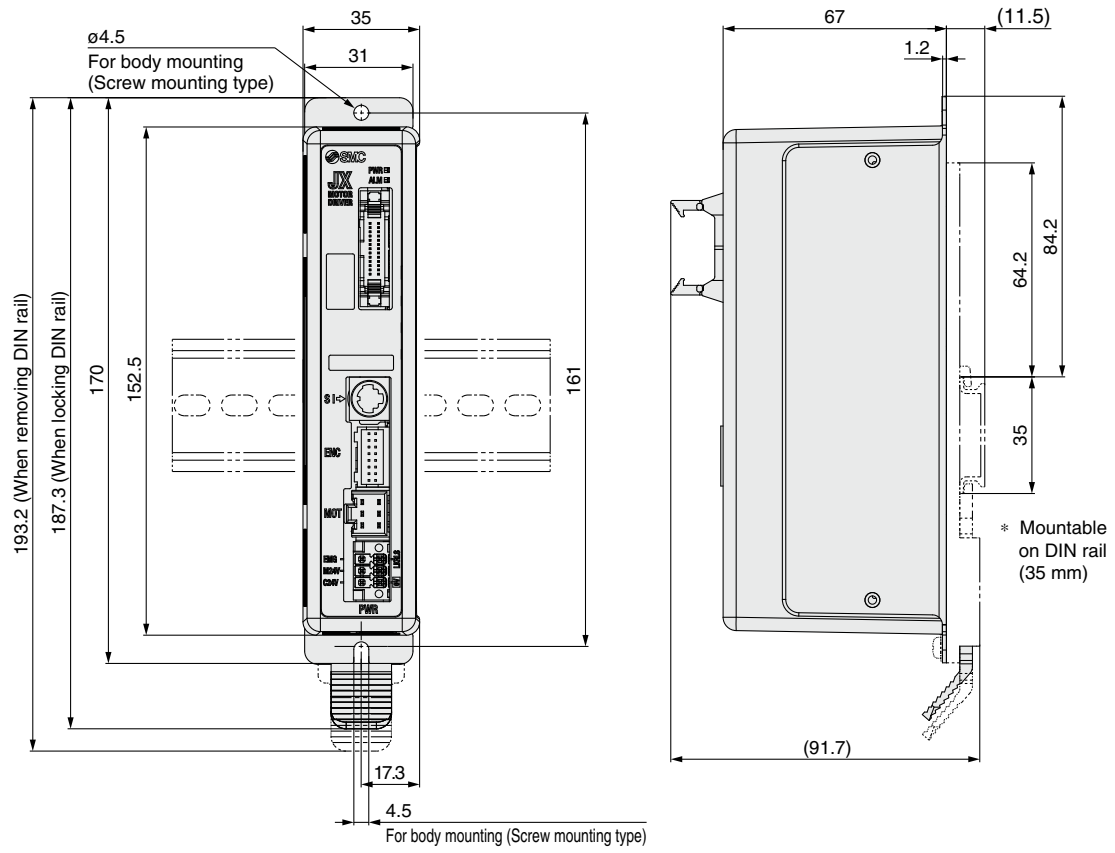

## Wiring Example 1

### Parallel I/O Connector

- \* When you connect a PLC to the parallel I/O connector, use the I/O cable (LEC-CN5-□).
- \* The wiring changes depending on the type of parallel I/O (NPN or PNP).

### Wiring diagram JXC5H□□ (NPN)

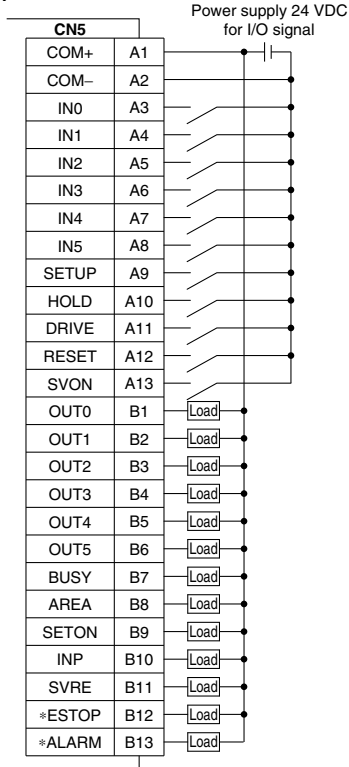

### JXC6H□□ (PNP)

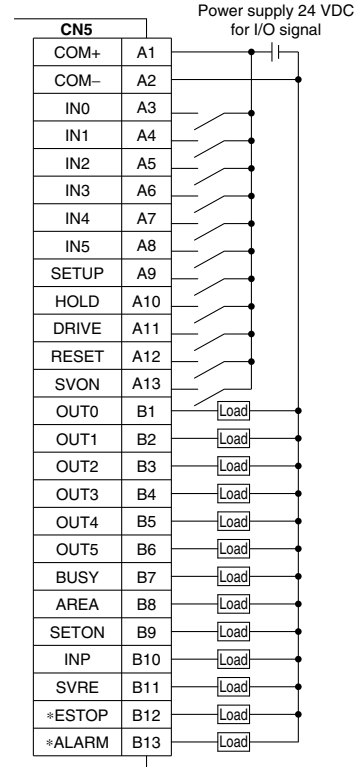

### Input Signal

Name	Details
COM+	Connects the power supply 24 V for input/output signal
COM-	Connects the power supply 0 V for input/output signal
IN0 to IN5	Step data specified bit no. (Input is instructed by combining IN0 to 5.)
SETUP	Instruction to return to origin
HOLD	Temporarily stops operation
DRIVE	Instruction to drive
RESET	Resets alarm and interrupts operation
SVON	Servo ON instruction

### Output Signal

Name	Details
OUT0 to OUT5	Outputs the step data no. during operation
BUSY	Outputs when the actuator is moving
AREA	Outputs within the step data area output setting range
SETON	Outputs when returning to origin
INP	Outputs when target position or target force is reached (Turns on when the positioning or pushing is completed.)
SVRE	Outputs when servo is on
*ESTOP* <sup>*1</sup>	OFF when EMG stop is instructed
*ALARM* <sup>*1</sup>	OFF when alarm is generated

\*<sup>1</sup> Signal of negative-logic circuit (N.C.)

## Step Data Setting

### 1. Step data setting for positioning

In this setting, the actuator moves toward and stops at the target position.

The following diagram shows the setting items and operation. The setting items and set values for this operation are stated below.

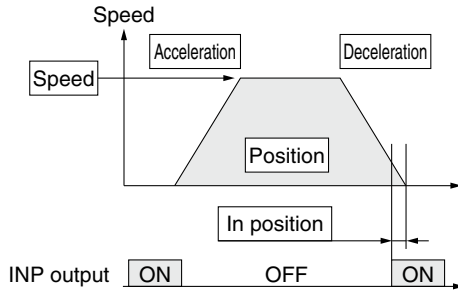

- ◎ : Need to be set.
- : Need to be adjusted as required.
- : Setting is not required.

#### Step Data (Positioning)

Necessity	Item	Details
◎	Movement MOD	When the absolute position is required, set Absolute. When the relative position is required, set Relative.
◎	Speed	Transfer speed to the target position
◎	Position	Target position
○	Acceleration	Parameter which defines how rapidly the actuator reaches the speed set. The higher the set value, the faster it reaches the speed set.
○	Deceleration	Parameter which defines how rapidly the actuator comes to stop. The higher the set value, the quicker it stops.
◎	Pushing force	Set 0. (If values 1 to 100 are set, the operation will be changed to the pushing operation.)
—	Trigger LV	Setting is not required.
—	Pushing speed	Setting is not required.
○	Moving force	Max. torque during the positioning operation (No specific change is required.)
○	Area 1, Area 2	Condition that turns on the AREA output signal.
○	In position	Condition that turns on the INP output signal. When the actuator enters the range of [in position], the INP output signal turns on. (It is unnecessary to change this from the initial value.) When it is necessary to output the arrival signal before the operation is completed, make the value larger.

### 2. Step data setting for pushing

The actuator moves toward the pushing start position, and when it reaches that position, it starts pushing with the set force or less.

The following diagram shows the setting items and operation. The setting items and set values for this operation are stated below.

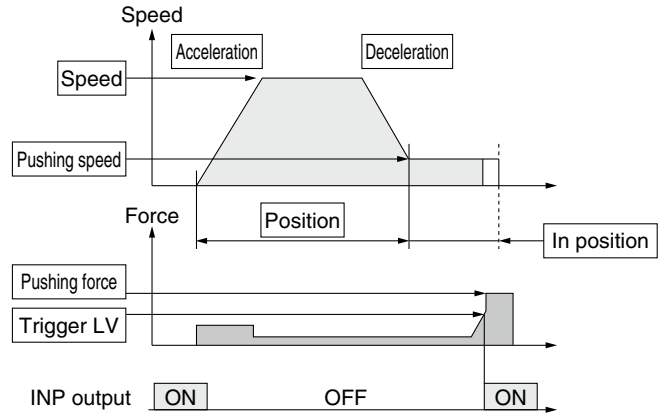

- ◎ : Need to be set.
- : Need to be adjusted as required.

#### Step Data (Pushing)

Necessity	Item	Details
◎	Movement MOD	When the absolute position is required, set Absolute. When the relative position is required, set Relative.
◎	Speed	Transfer speed to the pushing start position
◎	Position	Pushing start position
○	Acceleration	Parameter which defines how rapidly the actuator reaches the speed set. The higher the set value, the faster it reaches the speed set.
○	Deceleration	Parameter which defines how rapidly the actuator comes to stop. The higher the set value, the quicker it stops.
◎	Pushing force	Pushing force ratio is defined. The setting range differs depending on the electric actuator type. Refer to the operation manual for the electric actuator.
◎	Trigger LV	Condition that turns on the INP output signal. The INP output signal turns on when the generated force exceeds the value. Trigger level should be the pushing force or less.
○	Pushing speed	Pushing speed during pushing. When the speed is set fast, the electric actuator and workpieces might be damaged due to the impact when they hit the end, so this set value should be smaller. Refer to the operation manual for the electric actuator.
○	Moving force	Max. torque during the positioning operation (No specific change is required.)
○	Area 1, Area 2	Condition that turns on the AREA output signal.
◎	In position	Transfer distance during pushing. If the transferred distance exceeds the setting, it stops even if it is not pushing. If the transfer distance is exceeded, the INP output signal will not turn on.

## Signal Timing

### Return to Origin

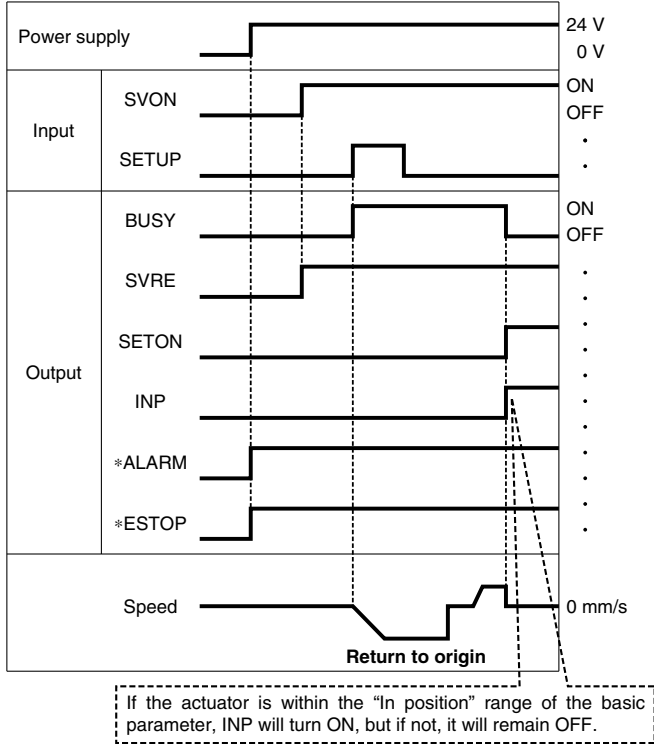

\* \*ALARM" and \*ESTOP" are expressed as negative-logic circuits.

### Positioning Operation

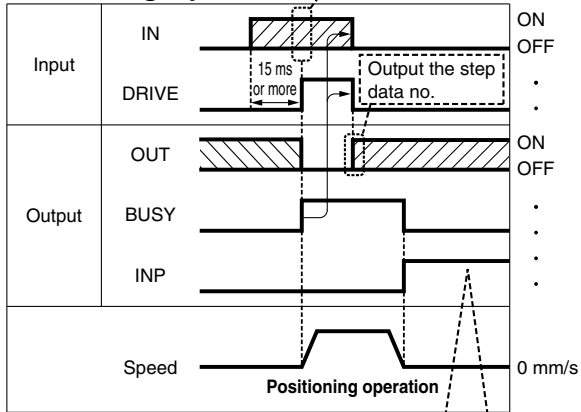

\* "OUT" is output when "DRIVE" is changed from ON to OFF. Refer to the operation manual for details on the controller for the LEM series. (When power supply is applied, "DRIVE" or "RESET" is turned ON or \*ESTOP" is turned OFF, all of the "OUT" outputs are OFF.)

### HOLD

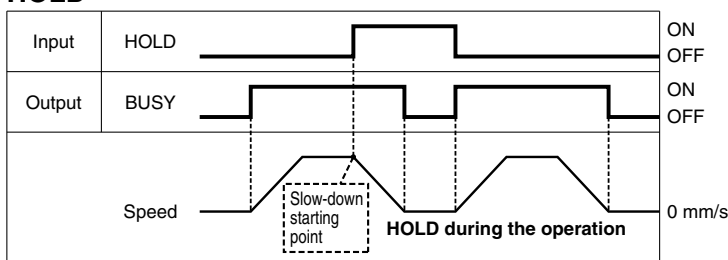

\* When the actuator is within the "In position" range in the pushing operation, it does not stop even if HOLD signal is input.

### Pushing Operation

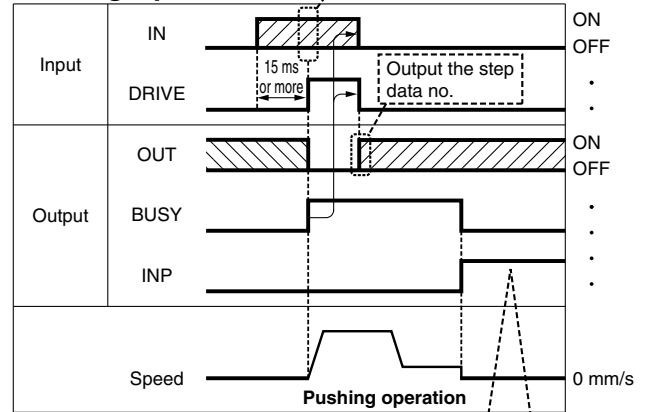

### Reset

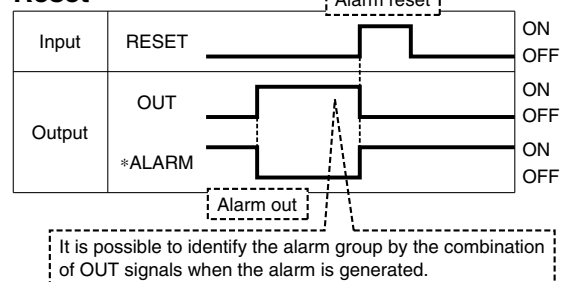

\* \*ALARM" is expressed as a negative-logic circuit.

# JXC5H/6H Series

## Options

### ■ Communication cable for controller setting

#### ① Communication cable JXC-W2A-C

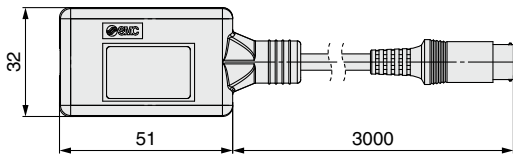

\* It can be connected to the controller directly.

#### ② USB cable LEC-W2-U

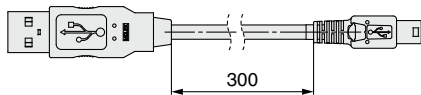

#### ③ Controller setting kit JXC-W2A

A set which includes a communication cable (JXC-W2A-C) and a USB cable (LEC-W2-U)

#### <Controller setting software/USB driver>

- Controller setting software
- USB driver (For JXC-W2A-C)

Download from SMC's website:

#### Hardware Requirements

OS	Windows®7, Windows®8.1, Windows®10
Communication interface	USB 1.1 or USB 2.0 ports
Display	1024 x 768 or more

\* Windows®7, Windows®8.1, and Windows®10 are registered trademarks of Microsoft Corporation in the United States.

### ■ Conversion cable P5062-5 (Cable length: 300 mm)

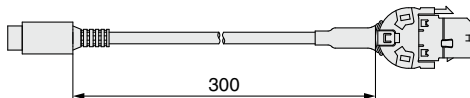

\* To connect the teaching box (LEC-T1-3□J□G□) or controller setting kit (LEC-W2□) to the controller, a conversion cable is required.

### ■ I/O cable

#### LEC-CN5-1

Cable length (L) [m]	
1	1.5
3	3
5	5

\* Conductor size: AWG28

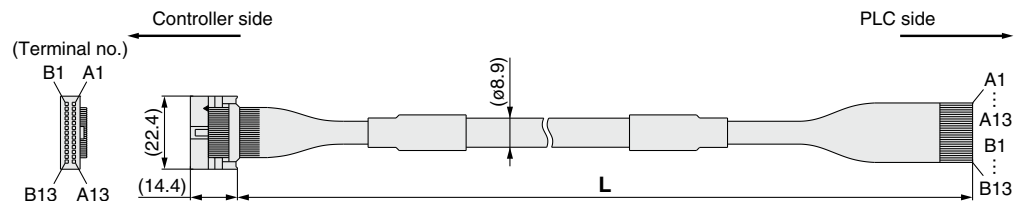

Connector pin no.	Insulation color	Dot mark	Dot color
A1	Light brown	■	Black
A2	Light brown	■	Red
A3	Yellow	■	Black
A4	Yellow	■	Red
A5	Light green	■	Black
A6	Light green	■	Red
A7	Gray	■	Black
A8	Gray	■	Red
A9	White	■	Black
A10	White	■	Red
A11	Light brown	■ ■	Black
A12	Light brown	■ ■	Red
A13	Yellow	■ ■	Black

Connector pin no.	Insulation color	Dot mark	Dot color
B1	Yellow	■ ■	Red
B2	Light green	■ ■	Black
B3	Light green	■ ■	Red
B4	Gray	■ ■	Black
B5	Gray	■ ■	Red
B6	White	■ ■	Black
B7	White	■ ■	Red
B8	Light brown	■ ■ ■	Black
B9	Light brown	■ ■ ■	Red
B10	Yellow	■ ■ ■	Black
B11	Yellow	■ ■ ■	Red
B12	Light green	■ ■ ■	Black
B13	Light green	■ ■ ■	Red
—			Shield

#### Weight

Product no.	Weight [g]
LEC-CN5-1	170
LEC-CN5-3	320
LEC-CN5-5	520

### ■ Power supply plug JXC-CPW

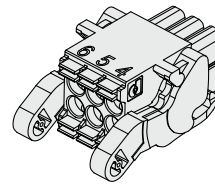

\* The power supply plug is an accessory.  
<Applicable cable size> AWG20 (0.5 mm<sup>2</sup>), cover diameter 2.0 mm or less

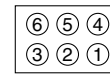

- ① C24V
- ② M24V
- ③ EMG
- ④ 0V
- ⑤ N.C.
- ⑥ LK RLS

#### Power supply plug

Terminal name	Function	Details
0V	Common supply (-)	The M24V terminal, C24V terminal, EMG terminal, and LK RLS terminal are common (-).
M24V	Motor power supply (+)	Motor power supply (+) of the controller
C24V	Control power supply (+)	Control power supply (+) of the controller
EMG	Stop (+)	Connection terminal of the external stop circuit
LK RLS	Lock release (+)	Connection terminal of the lock release switch

### ■ Teaching box

#### LEC-T1-3□J□G□

Teaching box

Cable length [m]  
3 3

Initial language

J	Japanese
E	English

\* The displayed language can be changed to English or Japanese.



Enable switch

Nil	None
S	Equipped with enable switch

\* Interlock switch for jog and test function

Stop switch

G	Equipped with stop switch
---	---------------------------

#### Specifications

Item	Description
Switch	Stop switch, Enable switch (Option)
Cable length [m]	3
Enclosure	IP64 (Except connector)
Operating temperature range [°C]	5 to 50
Operating humidity range [%RH]	90 or less (No condensation)
Weight [g]	350 (Except cable)

# High Performance Step Motor Controller

## JXCEH/9H/PH Series



### How to Order

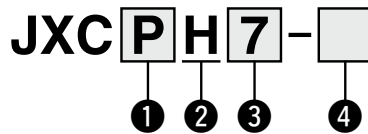

#### ① Communication protocol

<b>E</b>	EtherCAT
<b>9</b>	EtherNet/IP™
<b>P</b>	PROFINET

#### ② Specifications

<b>H</b>	1 axis/High performance type
----------	------------------------------

#### ③ Mounting

<b>7</b>	Screw mounting
<b>8*1</b>	DIN rail

\*1 The DIN rail is not included. It must be ordered separately. (Refer to page 42.)

#### ④ Actuator part number

Without cable specifications and actuator options Example: Enter " <b>LEKFS25GA-400</b> " for the LEKFS25GA-400B-R1C□H□□.	
<b>BC</b>	Blank controller*1

\*1 Requires dedicated software (JXC-BCW)

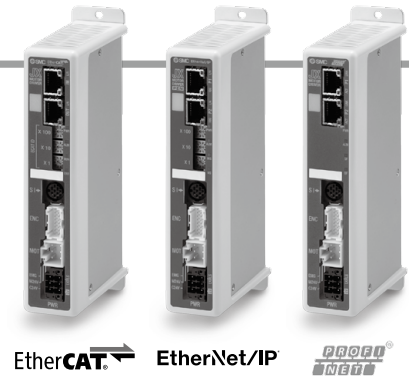

Model Selection

LEKFS□G Series

Auto Switch

JXC5H/6H Series

JXCEH/9H/PH Series

### The controller is sold as single unit after the compatible actuator is set.

Confirm that the combination of the controller and actuator is correct.

- ① Check the actuator label for the model number. This number should match that of the controller.

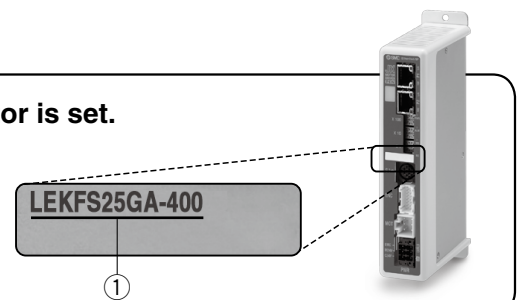

\* Refer to the operation manual for using the products. Please download it via our website.

### Precautions for blank controllers (JXC□H□-BC)

A blank controller is a controller to which the customer can write the data of the actuator it is to be combined and used with. For data writing, use the controller setting software ACT Controller 2 or the dedicated software JXC-BCW.

- Both ACT Controller 2 and JXC-BCW can be downloaded from the SMC website.
- To use this software, order the communication cable for controller setting (JXC-W2A-C) and the USB cable (LEC-W2-U) separately.

#### Hardware Requirements

OS	Windows®10 (64 bit)	Windows®7	Windows®8	Windows®10
Software	ACT Controller 2 (With JXC-BCW function)	JXC-BCW		

\* Windows®7, Windows®8, and Windows®10 are registered trademarks of Microsoft Corporation in the United States.

### ⚠ Caution

#### [CE/UKCA-compliant products]

- ① EMC compliance was tested by combining the electric actuator LE series and the JXCEH/PH series. The EMC depends on the configuration of the customer's control panel and the relationship with other electrical equipment and wiring. Therefore, compliance with the EMC directive cannot be certified for SMC components incorporated into the customer's equipment under actual operating conditions. As a result, it is necessary for the customer to verify compliance with the EMC directive for the machinery and equipment as a whole.
- ② For the JXCEH/PH series (step motor controller), EMC compliance was tested by installing a noise filter set (LEC-NFA). Refer to page 42 for the noise filter set. Refer to the JXCEH/PH Operation Manual for installation.

# JXCEH/9H/PH Series

## Specifications

Model		JXCEH	JXC9H	JXCPH
Network		EtherCAT	EtherNet/IP™	PROFINET
Compatible motor		Step motor (Servo/24 VDC)		
Power supply		Power voltage: 24 VDC ±10%		
Current consumption (Controller)		200 mA or less	200 mA or less	200 mA or less
Compatible encoder		Battery-less absolute		
Communication specifications	Applicable system	Protocol	EtherCAT*2	PROFINET*2
		Version*1	Conformance Test Record V.1.2.6	Specification Version 2.32
	Communication speed	100 Mbps*2	10/100 Mbps*2 (Automatic negotiation)	100 Mbps*2
	Configuration file*3	ESI file	EDS file	GSDML file
	I/O occupation area	Input 20 bytes Output 36 bytes	Input 36 bytes Output 36 bytes	Input 36 bytes Output 36 bytes
	Terminating resistor	Not included		
Memory		EEPROM		
LED indicator		PWR, RUN, ALM, ERR	PWR, ALM, MS, NS	PWR, ALM, SF, BF
Cable length [m]		Actuator cable: 20 or less		
Cooling system		Natural air cooling		
Operating temperature range [°C]		0 to 40 (No freezing)		
Operating humidity range [%RH]		90 or less (No condensation)		
Insulation resistance [MΩ]		Between all external terminals and the case: 50 (500 VDC)		
Weight [g]		260 (Screw mounting) 280 (DIN rail mounting)	250 (Screw mounting) 270 (DIN rail mounting)	260 (Screw mounting) 280 (DIN rail mounting)

\*1 Please note that versions are subject to change.

\*2 Use a shielded communication cable with CAT5 or higher for the PROFINET, EtherNet/IP™, and EtherCAT.

\*3 The files can be downloaded from the SMC website.

### ■ Trademark

EtherNet/IP® is a registered trademark of ODVA, Inc.

EtherCAT® is registered trademark and patented technology, licensed by Beckhoff Automation GmbH, Germany.

## Example of Operation Command

In addition to the step data input of 64 points maximum in each communication protocol, the changing of each parameter can be performed in real time via numerical data defined operation.

\* Numerical values other than "Moving force," "Area 1," and "Area 2" can be used to perform operation under numerical instructions from JXCL1.

### <Application example> Movement between 2 points

No.	Movement mode	Speed	Position	Acceleration	Deceleration	Pushing force	Trigger LV	Pushing speed	Moving force	Area 1	Area 2	In position
0	1: Absolute	100	10	3000	3000	0	0	0	100	0	0	0.50
1	1: Absolute	100	100	3000	3000	0	0	0	100	0	0	0.50

### <Step no. defined operation>

Sequence 1: Servo ON instruction

Sequence 2: Instruction to return to origin

Sequence 3: Specify step data No. 0 to input the DRIVE signal.

Sequence 4: Specify step data No. 1 after the DRIVE signal has been temporarily turned OFF to input the DRIVE signal.

### <Numerical data defined operation>

Sequence 1: Servo ON instruction

Sequence 2: Instruction to return to origin

Sequence 3: Specify step data No. 0 and turn ON the input instruction flag (position). Input 10 in the target position. Subsequently the start flag turns ON.

Sequence 4: Turn ON step data No. 0 and the input instruction flag (position) to change the target position to 100 while the start flag is ON.

The same operation can be performed with any operation command.

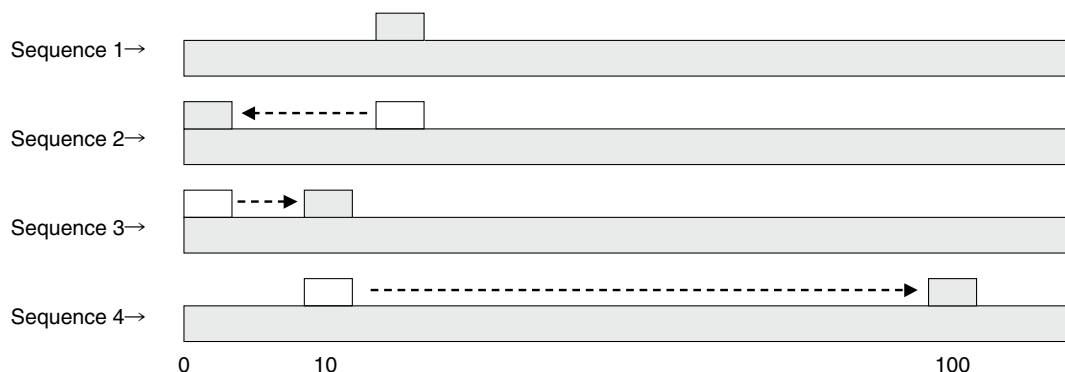



**Dimensions**

**JXCEH**

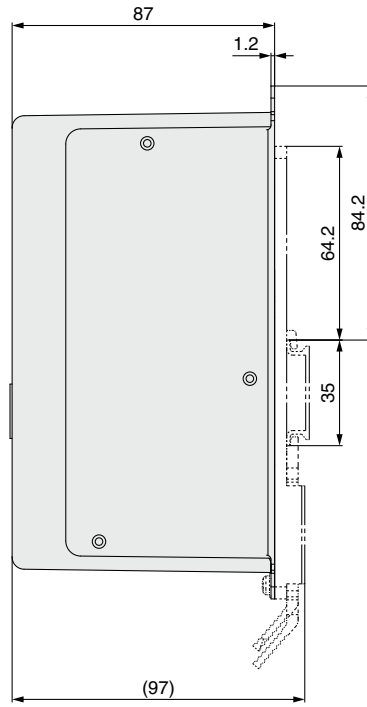
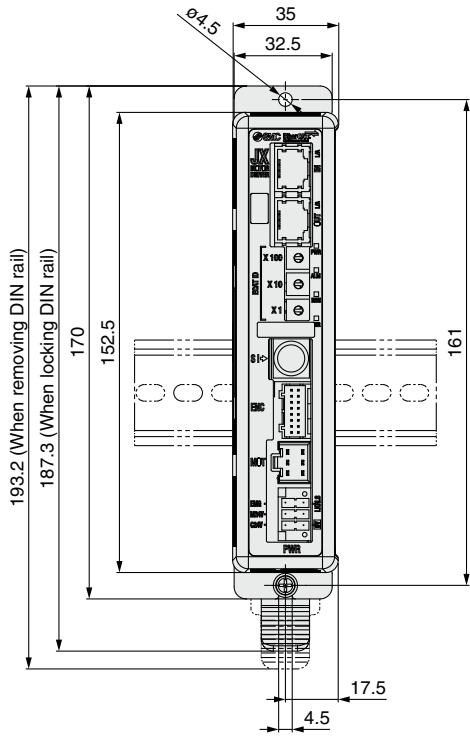

**JXC9H**

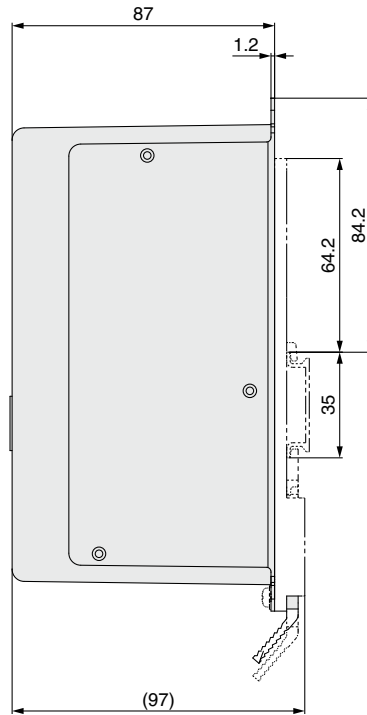
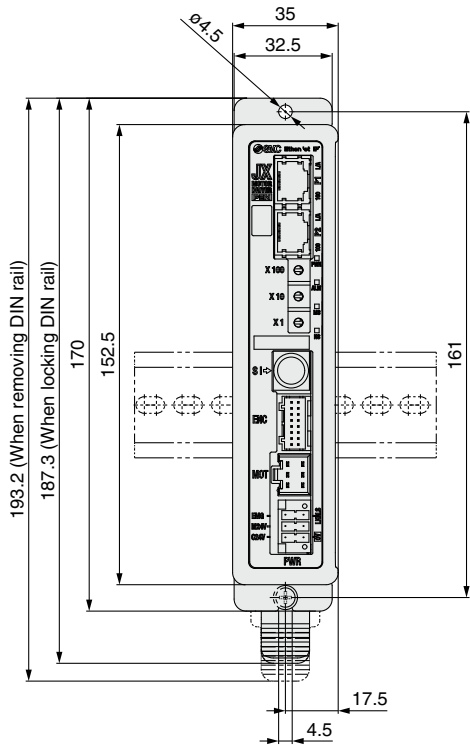

Model Selection

LEKFS  G Series

Auto Switch

JXC5H/6H Series

JXCEH/9H/PH Series

# JXCEH/9H/PH Series

## Dimensions

### JXCPH

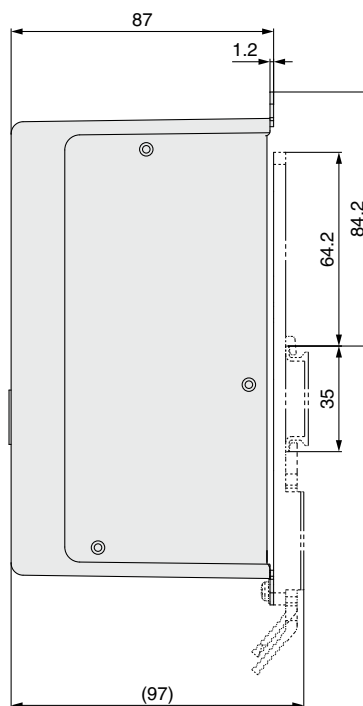
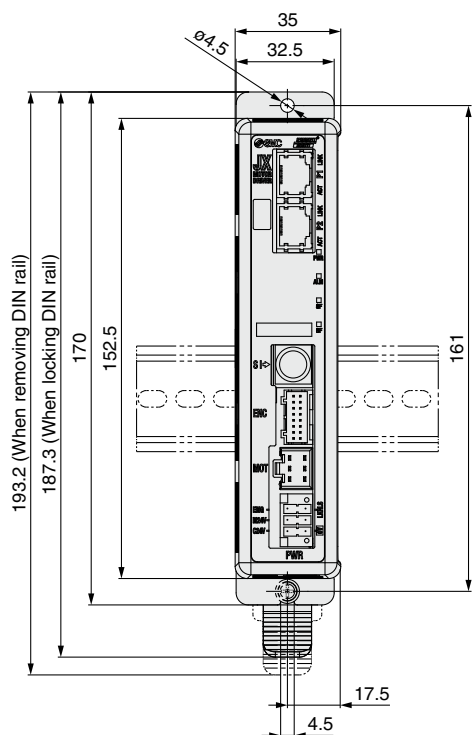

### DIN rail

#### AXT100-DR-□

\* For □, enter a number from the No. line in the table below.

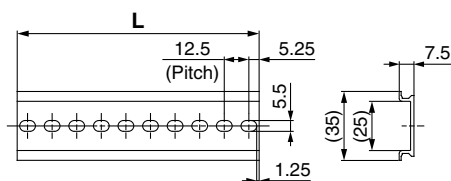

### L Dimensions [mm]

No.	1	2	3	4	5	6	7	8	9	10	11	12	13	14	15	16	17	18	19	20
<b>L</b>	23	35.5	48	60.5	73	85.5	98	110.5	123	135.5	148	160.5	173	185.5	198	210.5	223	235.5	248	260.5
No.	21	22	23	24	25	26	27	28	29	30	31	32	33	34	35	36	37	38	39	40
<b>L</b>	273	285.5	298	310.5	323	335.5	348	360.5	373	385.5	398	410.5	423	435.5	448	460.5	473	485.5	498	510.5

### DIN rail mounting adapter

#### LEC-3-D0 (with 2 mounting screws)

This should be used when the DIN rail mounting adapter is mounted onto a screw mounting type controller afterward.

## Options

### ■ Communication cable for controller setting

#### ① Communication cable JXC-W2A-C

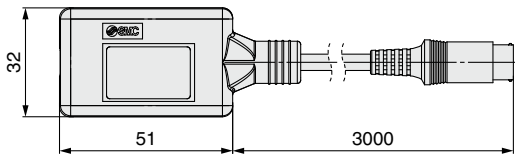

\* It can be connected to the controller directly.

#### ② USB cable LEC-W2-U

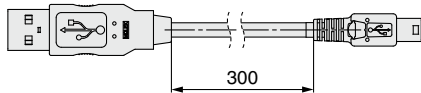

#### ③ Controller setting kit JXC-W2A

A set which includes a communication cable (JXC-W2A-C) and a USB cable (LEC-W2-U)

<Controller setting software/USB driver>

- Controller setting software
- USB driver (For JXC-W2A-C)

Download from SMC's website.

#### Hardware Requirements

OS	Windows®7, Windows®8.1, Windows®10
Communication interface	USB 1.1 or USB 2.0 ports
Display	1024 x 768 or more

\* Windows®7, Windows®8.1 and Windows®10 are registered trademarks of Microsoft Corporation in the United States.

### ■ DIN rail mounting adapter LEC-3-D0

\* With 2 mounting screws

This should be used when the DIN rail mounting adapter is mounted onto a screw mounting type controller afterward.

### ■ DIN rail AXT100-DR-□

\* For □, enter a number from the No. line in the table on page 41. Refer to the dimension drawings on pages 40 and 41 for the mounting dimensions.

### ■ Teaching box

**LEC-T1-3 J G**

Teaching box

Cable length [m]	3
------------------	---

Initial language

J	Japanese
E	English

\* The displayed language can be changed to English or Japanese.

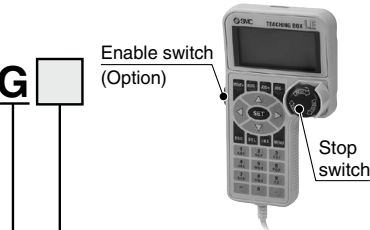

Enable switch

Nil	None
S	Equipped with enable switch

\* Interlock switch for jog and test function

Stop switch

G	Equipped with stop switch
---	---------------------------

#### Specifications

Item	Description
Switch	Stop switch, Enable switch (Option)
Cable length [m]	3
Enclosure	IP64 (Except connector)
Operating temperature range [°C]	5 to 50
Operating humidity range [%RH]	90 or less (No condensation)
Weight [g]	350 (Except cable)

### ■ Power supply plug JXC-CPW

\* The power supply plug is an accessory.

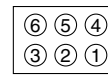
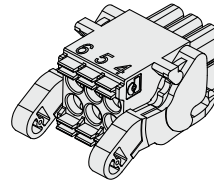

- |        |          |
|--------|----------|
| ① C24V | ④ 0V     |
| ② M24V | ⑤ N.C.   |
| ③ EMG  | ⑥ LK RLS |

#### Power supply plug

Terminal name	Function	Details
0V	Common supply (-)	The M24V terminal, C24V terminal, EMG terminal, and LK RLS terminal are common (-).
M24V	Motor power supply (+)	Motor power supply (+) of the controller
C24V	Control power supply (+)	Control power supply (+) of the controller
EMG	Stop (+)	Connection terminal of the external stop circuit
LK RLS	Lock release (+)	Connection terminal of the lock release switch

### ■ Conversion cable P5062-5 (Cable length: 300 mm)

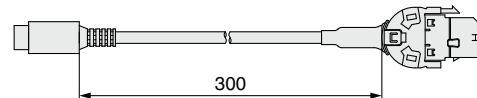

\* To connect the teaching box (LEC-T1-3□G□) or controller setting kit (LEC-W2) to the controller, a conversion cable is required.

### ■ Noise filter set

## LEC-NFA

Contents of the set: 2 noise filters

(Manufactured by WURTH ELEKTRONIK: 74271222)

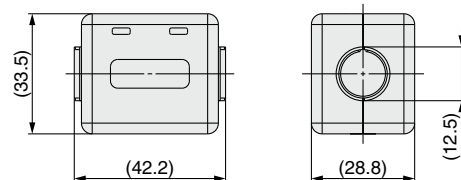

\* Refer to the JXCEH/PH series Operation Manual for installation.

# JXC5H/6H Series JXCEH/9H/PH Series Actuator Cable (Option)

[Robotic cable for battery-less absolute (Step motor 24 VDC)]

**LE-CE-1**

Cable length (L) [m]

1	1.5
3	3
5	5
8	8*1
A	10*1
B	15*1
C	20*1

\*1 Produced upon receipt of order

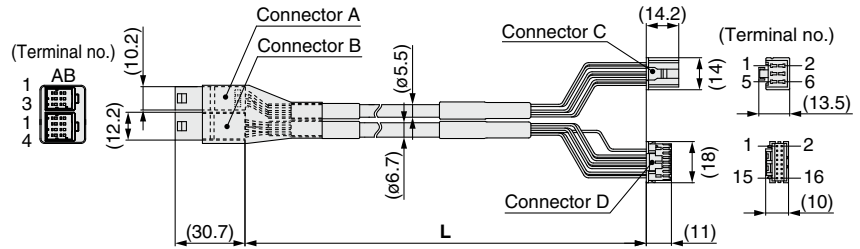

**Weight**

Product no.	Weight [g]	Note
LE-CE-1	190	Robotic cable
LE-CE-3	360	
LE-CE-5	570	
LE-CE-8	900	
LE-CE-A	1120	
LE-CE-B	1680	
LE-CE-C	2210	

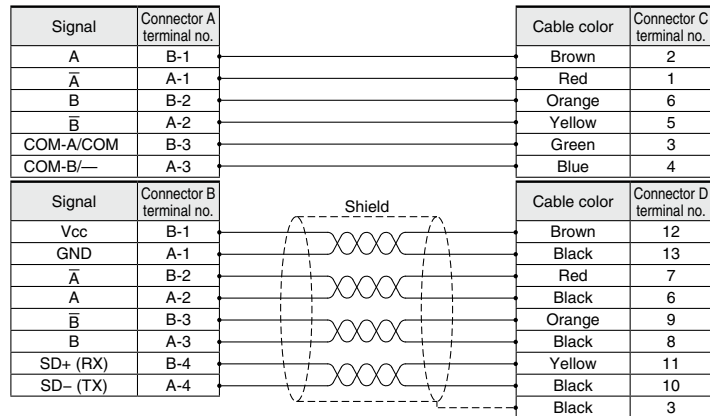

[Robotic cable with lock for battery-less absolute (Step motor 24 VDC)]

**LE-CE-1-B**

Cable length (L) [m]

1	1.5
3	3
5	5
8	8*1
A	10*1
B	15*1
C	20*1

\*1 Produced upon receipt of order

**With lock and sensor**

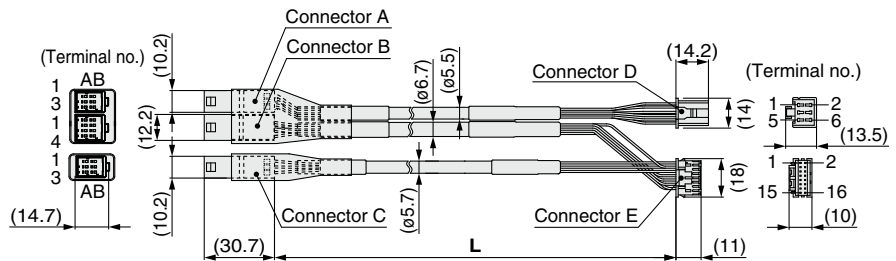

**Weight**

Product no.	Weight [g]	Note
LE-CE-1-B	240	Robotic cable
LE-CE-3-B	460	
LE-CE-5-B	740	
LE-CE-8-B	1170	
LE-CE-A-B	1460	
LE-CE-B-B	2120	
LE-CE-C-B	2890	

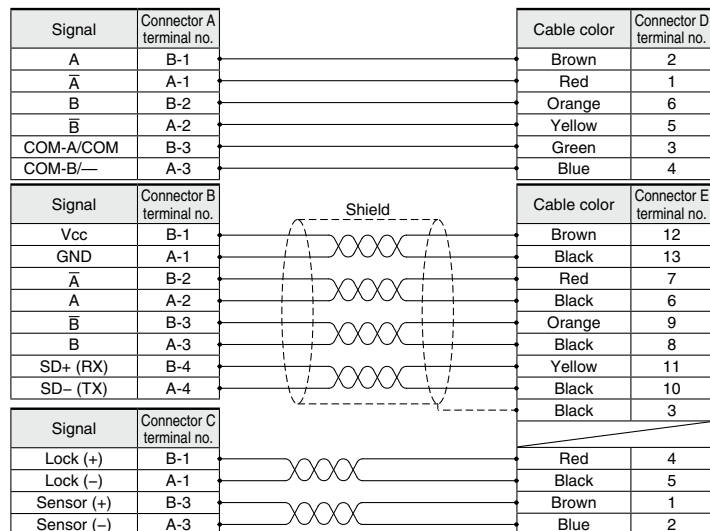



# LEKFS□G Series

## Battery-less Absolute Encoder Type Specific Product Precautions

Be sure to read this before handling the products. Refer to the back cover for safety instructions. For electric actuator precautions, refer to the “Handling Precautions for SMC Products” and the “Operation Manual” on the SMC website.

### Handling

#### ⚠ Caution

##### 1. Absolute encoder ID mismatch error at the first connection

In the following cases, an “ID mismatch error” alarm occurs after the power is turned ON. Perform a return to origin operation after resetting the alarm before use.

- When an electric actuator is connected and the power is turned ON for the first time after purchase\*1
- When the actuator or motor is replaced
- When the controller is replaced

\*1 If you have purchased an electric actuator and controller with the set part number, the pairing may have already been completed and the alarm may not be generated.

##### “ID mismatch error”

Operation is enabled by matching the encoder ID on the electric actuator side with the ID registered in the controller. This alarm occurs when the encoder ID is different from the registered contents of the controller. By resetting this alarm, the encoder ID is registered (paired) to the controller again.

When a controller is changed after pairing is completed				
	Encoder ID no. (* Numbers below are examples.)			
Actuator	17623	17623	17623	17623
Controller	17623	17699	17699	17623
ID mismatch error occurred?	No	Yes	Error reset ⇒ No	

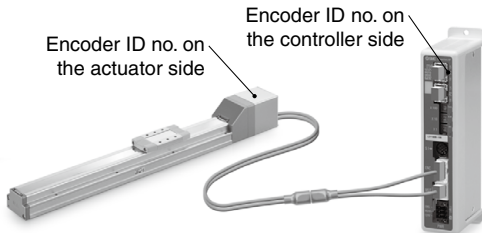

The ID number is automatically checked when the control power supply is turned ON. An error is output if the ID number does not match.

##### 2. In environments where strong magnetic fields are present, use may be limited.

A magnetic sensor is used in the encoder. Therefore, if the actuator motor is used in an environment where strong magnetic fields are present, malfunction or failure may occur. Do not expose the actuator motor to magnetic fields with a magnetic flux density of 1 mT or more.

When installing an electric actuator and an air cylinder with an auto switch (ex. CDQ2 series) or multiple electric actuators side by side, maintain a space of 40 mm or more around the motor. Refer to the construction drawing of the actuator motor.

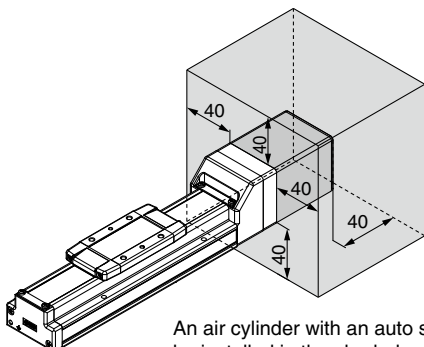

An air cylinder with an auto switch cannot be installed in the shaded area.

##### • When lining up actuators

SMC actuators can be used with their motors adjacent to each other. However, for actuators with a built-in auto switch magnet, maintain a space of 40 mm or more between the motors and the position where the magnet passes.

For the LEF series, the magnet is in the middle of the table, and for the LEY series, the magnet is in the piston portion. (Refer to the construction drawings in the catalog for details.)

○ Can be used with their motors adjacent to each other

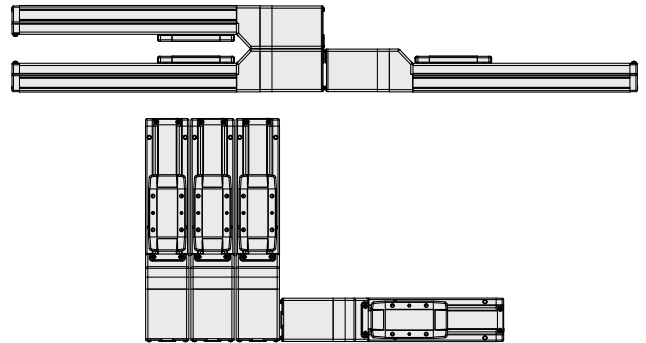

✗ Do not allow the motors to be in close proximity to the position where the magnet passes.

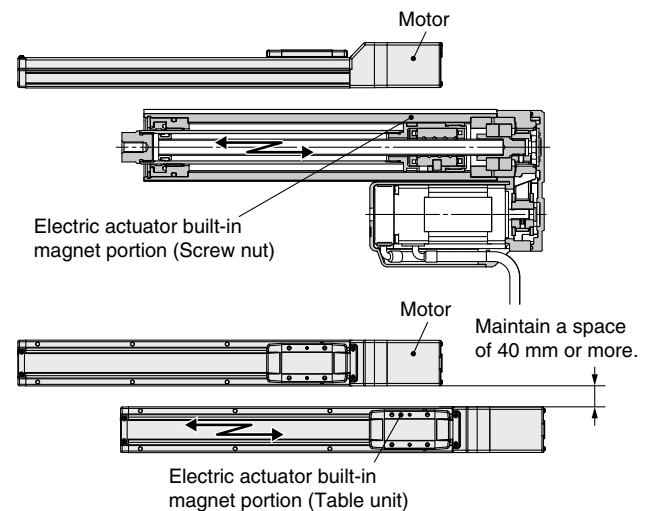

##### 3. The connector size of the motor cable is different from that of the electric actuator with an incremental encoder.

The motor cable connector of an electric actuator with a battery-less absolute encoder is different from that of an electric actuator with an incremental encoder. As the connector cover dimensions are different, take the dimensions below into consideration during the design process.

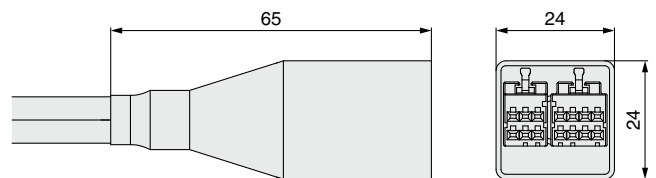

Battery-less absolute encoder connector cover dimensions

# CE/UKCA/UL-compliance List

\* For CE, UKCA, and UL-compliant products, refer to the tables below.

As of February 2022

## ■ Controllers “○”: Compliant “x”: Not compliant

Compatible motor	Series	CE UK CA	cUL <sup>us</sup>	
			Compliance	Certification No. (File No.)
High performance (Step motor 24 VDC)	JXC5H/6H	○	○	E480340
	JXCEH	○	○	E480340
	JXC9H	○	○	E480340
	JXCPH	○	○	E480340

## ■ Actuators “○”: Compliant “x”: Not compliant

Compatible motor	Series	CE UK CA	cUL <sup>us</sup>	
			Compliance	Certification No. (File No.)
High performance battery-less absolute (Step motor 24 VDC)	LEKFS□G	○	x	—

## ■ Actuators (When ordered with a controller) “○”: Compliant “x”: Not compliant “—”: Not applicable

Compatible motor	Series	JXC5H/6H			JXCEH			JXC9H			JXCPH		
		CE UK CA	cUL <sup>us</sup>		CE UK CA	cUL <sup>us</sup>		CE UK CA	cUL <sup>us</sup>		CE UK CA	cUL <sup>us</sup>	
			Compliance	Certification No. (File No.)		Compliance	Certification No. (File No.)		Compliance	Certification No. (File No.)		Compliance	Certification No. (File No.)
High performance battery-less absolute (Step motor 24 VDC)	LEKFS□G	○	x	—	○	x	—	○	x	—	○	x	—

## Safety Instructions

These safety instructions are intended to prevent hazardous situations and/or equipment damage. These instructions indicate the level of potential hazard with the labels of “**Caution**,” “**Warning**” or “**Danger**.” They are all important notes for safety and must be followed in addition to International Standards (ISO/IEC)\*1), and other safety regulations.

 **Caution:** **Caution** indicates a hazard with a low level of risk which, if not avoided, could result in minor or moderate injury.

 **Warning:** **Warning** indicates a hazard with a medium level of risk which, if not avoided, could result in death or serious injury.

 **Danger:** **Danger** indicates a hazard with a high level of risk which, if not avoided, will result in death or serious injury.

\*1) ISO 4414: Pneumatic fluid power – General rules relating to systems.  
ISO 4413: Hydraulic fluid power – General rules relating to systems.  
IEC 60204-1: Safety of machinery – Electrical equipment of machines.  
(Part 1: General requirements)  
ISO 10218-1: Manipulating industrial robots – Safety.  
etc.

### Warning

#### 1. The compatibility of the product is the responsibility of the person who designs the equipment or decides its specifications.

Since the product specified here is used under various operating conditions, its compatibility with specific equipment must be decided by the person who designs the equipment or decides its specifications based on necessary analysis and test results. The expected performance and safety assurance of the equipment will be the responsibility of the person who has determined its compatibility with the product. This person should also continuously review all specifications of the product referring to its latest catalog information, with a view to giving due consideration to any possibility of equipment failure when configuring the equipment.

#### 2. Only personnel with appropriate training should operate machinery and equipment.

The product specified here may become unsafe if handled incorrectly. The assembly, operation and maintenance of machines or equipment including our products must be performed by an operator who is appropriately trained and experienced.

#### 3. Do not service or attempt to remove product and machinery/equipment until safety is confirmed.

1. The inspection and maintenance of machinery/equipment should only be performed after measures to prevent falling or runaway of the driven objects have been confirmed.
2. When the product is to be removed, confirm that the safety measures as mentioned above are implemented and the power from any appropriate source is cut, and read and understand the specific product precautions of all relevant products carefully.
3. Before machinery/equipment is restarted, take measures to prevent unexpected operation and malfunction.

#### 4. Contact SMC beforehand and take special consideration of safety measures if the product is to be used in any of the following conditions.

1. Conditions and environments outside of the given specifications, or use outdoors or in a place exposed to direct sunlight.
2. Installation on equipment in conjunction with atomic energy, railways, air navigation, space, shipping, vehicles, military, medical treatment, combustion and recreation, or equipment in contact with food and beverages, emergency stop circuits, clutch and brake circuits in press applications, safety equipment or other applications unsuitable for the standard specifications described in the product catalog.
3. An application which could have negative effects on people, property, or animals requiring special safety analysis.
4. Use in an interlock circuit, which requires the provision of double interlock for possible failure by using a mechanical protective function, and periodical checks to confirm proper operation.

### Caution

#### 1. The product is provided for use in manufacturing industries.

The product herein described is basically provided for peaceful use in manufacturing industries.  
If considering using the product in other industries, consult SMC beforehand and exchange specifications or a contract if necessary.  
If anything is unclear, contact your nearest sales branch.

### Limited warranty and Disclaimer/ Compliance Requirements

The product used is subject to the following “Limited warranty and Disclaimer” and “Compliance Requirements”.

Read and accept them before using the product.

#### Limited warranty and Disclaimer

1. The warranty period of the product is 1 year in service or 1.5 years after the product is delivered, whichever is first.\*2)  
Also, the product may have specified durability, running distance or replacement parts. Please consult your nearest sales branch.
2. For any failure or damage reported within the warranty period which is clearly our responsibility, a replacement product or necessary parts will be provided.  
This limited warranty applies only to our product independently, and not to any other damage incurred due to the failure of the product.
3. Prior to using SMC products, please read and understand the warranty terms and disclaimers noted in the specified catalog for the particular products.

##### \*2) Vacuum pads are excluded from this 1 year warranty.

A vacuum pad is a consumable part, so it is warranted for a year after it is delivered.  
Also, even within the warranty period, the wear of a product due to the use of the vacuum pad or failure due to the deterioration of rubber material are not covered by the limited warranty.

#### Compliance Requirements

1. The use of SMC products with production equipment for the manufacture of weapons of mass destruction (WMD) or any other weapon is strictly prohibited.
2. The exports of SMC products or technology from one country to another are governed by the relevant security laws and regulations of the countries involved in the transaction. Prior to the shipment of a SMC product to another country, assure that all local rules governing that export are known and followed.

### Caution

#### SMC products are not intended for use as instruments for legal metrology.

Measurement instruments that SMC manufactures or sells have not been qualified by type approval tests relevant to the metrology (measurement) laws of each country. Therefore, SMC products cannot be used for business or certification ordained by the metrology (measurement) laws of each country.

## Safety Instructions

Be sure to read the “Handling Precautions for SMC Products” (M-E03-3) and “Operation Manual” before use.

**SMC Corporation**