

Remote Type Pressure Sensors/ Pressure Sensor Controllers



Compact Pneumatic Pressure Sensor

PSE530

▶p. 5



Compact Pneumatic Pressure Sensor/Switch

PSE540

▶p. 9



Low Differential Pressure Sensor

PSE550

▶p. 17



Pressure Sensor for General Fluids

PSE560

▶p. 20



Pressure Sensor/Switch for General Fluids

PSE570

▶p. 23



3-Screen Display

Multi-channel Digital Sensor Monitor

PSE200A

▶p. 32



3-Screen Display

Sensor Monitor

PSE300A

▶p. 44



Connector type

3-Screen Display

Sensor Monitor

PSE300AC

▶p. 54



DIN rail/
Terminal block type

PSE Series



CAT.ES100-56D

IO-Link Compatible

Two types of connection are supported depending on the application.

- For the communication of sensor data/Reduced installation space → Direct connection **PSE54□-L/PSE57□-L2**
- On site setting and the confirmation of measured values/Reduced wiring → Hub connection **PSE202A/203A**

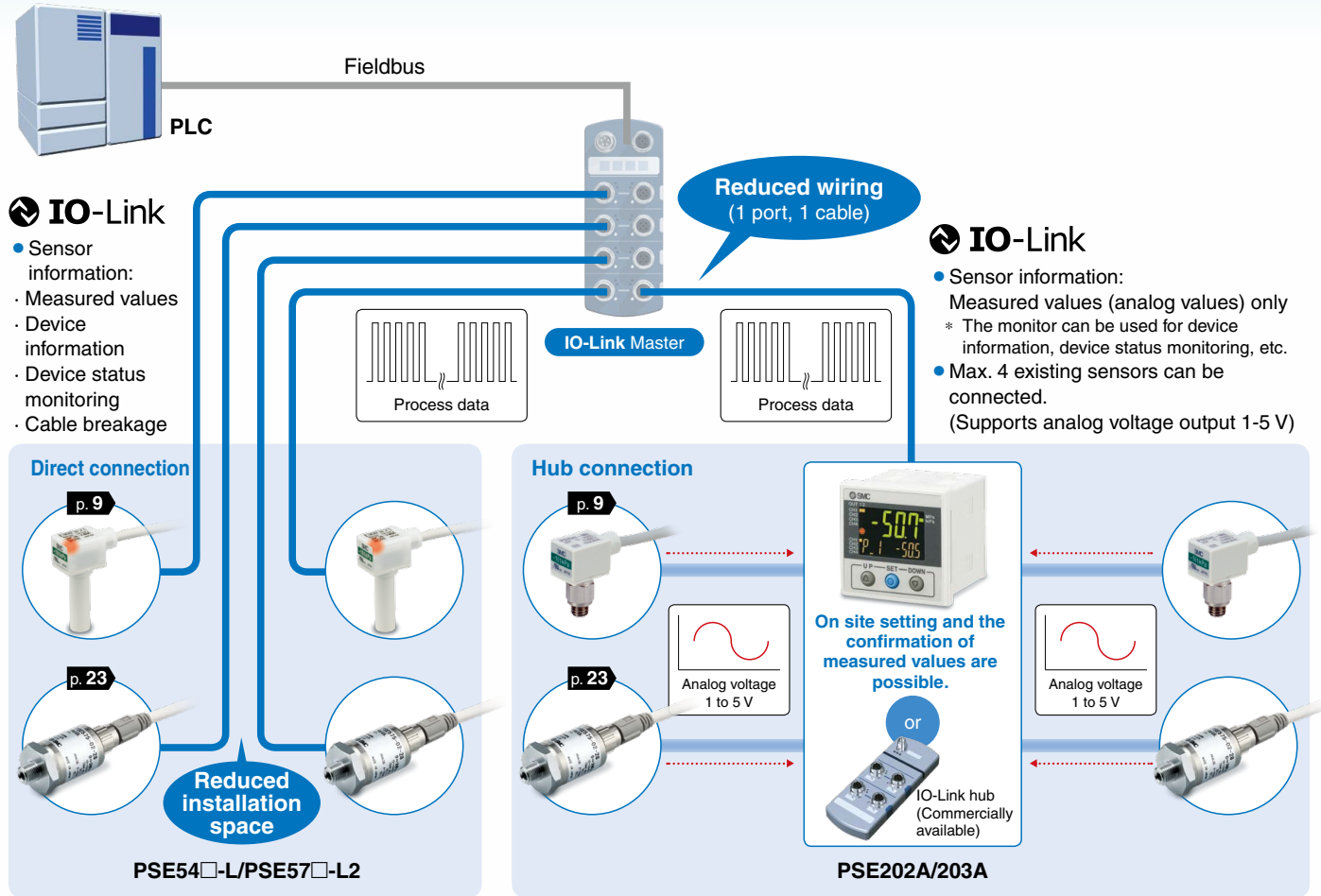

Compatible Series PSE54□-L / PSE57□-L2 p. 11, 25

■ Visualization of operation/equipment status/Remote monitoring and control by communication

■ Implement diagnostic bits in the process data.

The diagnostic bit in the cyclic process data makes it easy to find problems with the equipment. It is possible to find problems with the equipment in real time using the cyclic (periodic) data and to monitor such problems in detail with the noncyclic (aperiodic) data.

Process Data

Bit offset	Item	Note
0	OUT1 output	0: OFF 1: ON
1	OUT2 output	0: OFF 1: ON
8	Diagnosis (Measurement)	0: Normal 1: Abnormal
14	Diagnosis (Error)	0: Normal 1: Abnormal
15	Diagnosis (Error)	0: Normal 1: Abnormal
16 to 31	Measured pressure value	Signed 16 bit

Diagnosis items
Outside of rated pressure range
Internal product malfunction
• Over current
• Outside of zero-clear range
• IO-Link master version error
• Snapshot failure



Bit offset	31	30	29	28	27	26	25	24	23	22	21	20	19	18	17	16
Item	Measured pressure value (PD)															

Bit offset	15	14	13	12	11	10	9	8	7	6	5	4	3	2	1	0
Item	System error	Other than system error	Reservation					Measurement	Reservation					OUT2	OUT1	
	Diagnosis							Diagnosis						Switch output		

Compatible with small switches for general fluids

Application Example For hydraulic cylinder pressure control

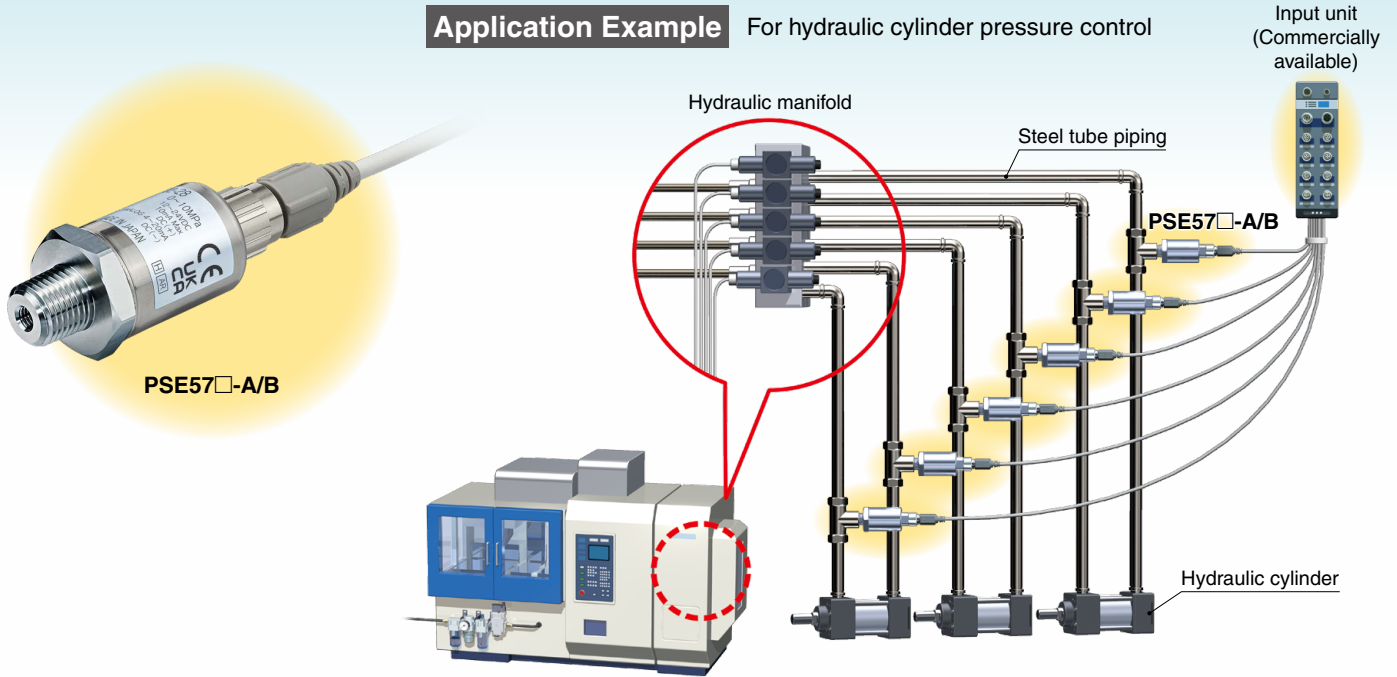

Switch Output Specification (Factory setting)

Eliminates the need to set the threshold value on-site, reducing labor!



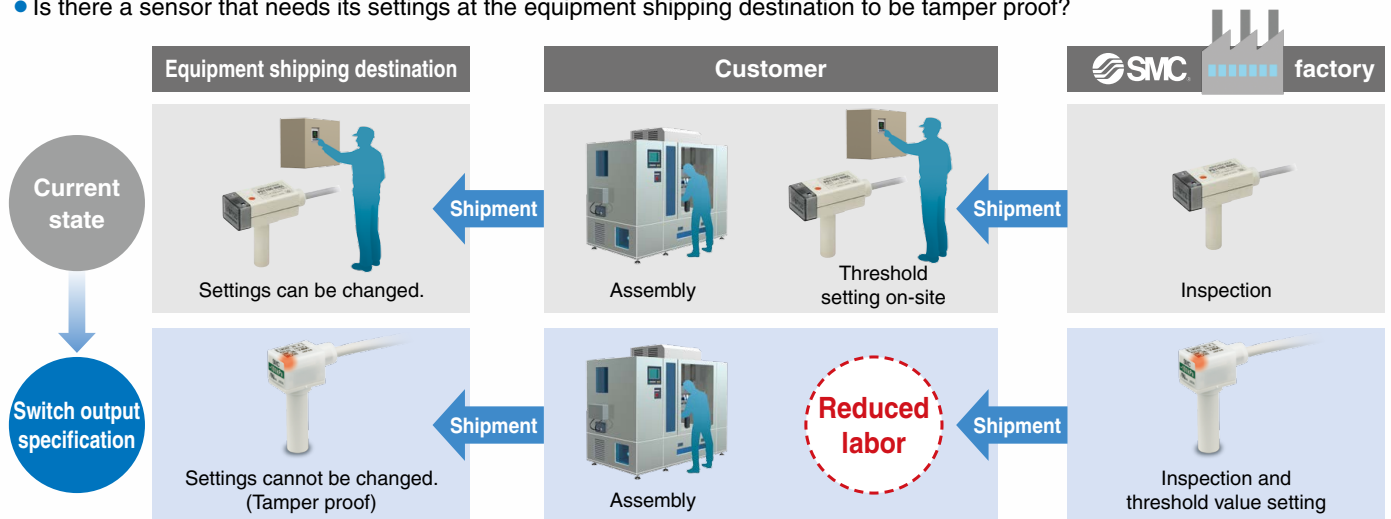





- Is there more than one sensor with the same settings in the same equipment?
- Are there repeat devices equipped with sensors with the same settings?
- Is there a sensor that needs its settings at the equipment shipping destination to be tamper proof?



Compatible Series



PSE Series Variations

		Pressure Sensors					Digital Sensor Monitors		
Model		PSE530	PSE540	PSE550	PSE560	PSE570	PSE200A	PSE300A	PSE300AC
									
		p. 5	p. 9	p. 17	p. 20	p. 23	p. 32	p. 44	p. 54
Basic Specifications	Applicable fluid	Air			General fluids				
	Rated pressure range (Min. display)								
	Repeatability	±1 % (F.S.)	±0.2 % (F.S.)	±0.3 % (F.S.)	±0.2 % (F.S.)	±0.2% (F.S.) PSE570/573/574 ±0.5% (F.S.) PSE575/576/577	±0.1 % (F.S.)		
	Voltage	12 to 24 VDC							
	No. of outputs for switch		1 output*1			2 outputs*1	5 outputs	2 outputs	2 outputs
	IO-Link		○*1			○*1	○		
	Analog output	1 to 5 V		1 to 5 V 4 to 20 mA				1 to 5 V 4 to 20 mA	
Functions	Digital display						2-color	2-color	2-color
	Enclosure	IP40			IP65		Front face: IP65 Others: IP40	IP40	IP65
	Wiring	Connector	Grommet			Connector	Connector		
	Main functions (Settings)						IO-Link compatible 3-screen display Panel mounting possible Display value fine adjustment function	3-screen display Panel mounting possible Display value fine adjustment function Anti-chattering function	3-screen display Display value fine adjustment function Selectable pressure unit
Others	Connection thread	M, Reducer	M, R, NPT, Reducer	Resin piping	R, NPT, Rc, URJ, TSJ*2	R			
	Int'l standards	CE/UKCA	CE/UKCA, UL, CSA			CE/UKCA, UL, CSA*3	CE/UKCA	CE/UKCA, UL, CSA	CE/UKCA
	Wiring	e-con	●	●	●	●	●	●	●
		Flexible cable		●	●	●			
	Mounting	Direct	●	●	●	●	●		●
		With bracket			●				●
		Panel mount						●	●
DIN rail									

*1 The IO-Link compatible switch output specification cannot be connected to the PSE200A/PSE300A(C).

*2 URJ: Face seal fitting, TSJ: Compression fitting *3 Excludes the IO-Link/2-output type

Pressure Sensor/PSE5□□ Series

		Rated pressure range				PSE53□	PSE54□	PSE55□	PSE56□	PSE57□
		-100 kPa	0	100 kPa	500 kPa	1 MPa	2 MPa	5 MPa	10 MPa	
Vacuum										
Compound pressure										
Positive pressure										
Low differential pressure										

Digital Sensor Monitor/PSE200A/300A Series

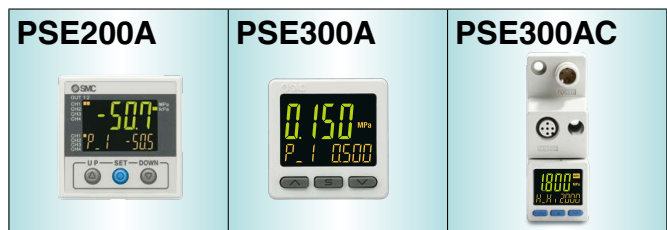

Applicable pressure sensor model*1					Display/Smallest settable increment		
PSE531	PSE541	—	PSE561	—	0.1 kPa	0.1 kPa	0.1 kPa
PSE533	PSE543	—	PSE563	PSE573	0.1 kPa	0.2 kPa	0.1 kPa
PSE532	—	—	—	—	0.1 kPa	0.1 kPa	0.1 kPa
—	—	—	PSE564	PSE574	—	1 kPa	1 kPa
PSE530	PSE540	—	PSE560	PSE570	0.001 MPa	0.001 MPa	0.001 MPa
—	—	PSE550	—	—	—	0.01 kPa	0.001 kPa

* Analog output only

Main Functions * For details, refer to the “Operation Manual” on the SMC website.

Key-lock	Locks the keys to prevent accidental operation
Peak/Bottom value holding	Displays the min. and max. values being set and keeps those values on the display
Auto-preset	Allows for the pressure to be set automatically In the case of suction verification, it memorizes the pressure when adsorbed and released. After repeating several times, the optimum values are calculated automatically.
Auto-shift	Stable switch output is possible even when the supply pressure fluctuates. The set value is corrected automatically in accordance with the fluctuations in the supply pressure.
Display value fine adjustment	Allows for the displayed values to be adjusted (±5%) and the evening out of the variations in the displayed values of each pressure switch
Anti-chattering	Prevents malfunction due to sharp pressure fluctuations The detection of momentary pressure fluctuation as abnormal pressure can be prevented by changing the response time settings.

Compact Pneumatic Pressure Sensor

PSE530 Series

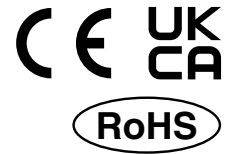

Series	Rated pressure range				
	-100 kPa	0	100 kPa	500 kPa	1 MPa
PSE530		0	1 MPa		1 MPa
PSE531	-101 kPa	0			
PSE532		0	101 kPa		
PSE533	-101 kPa		101 kPa		

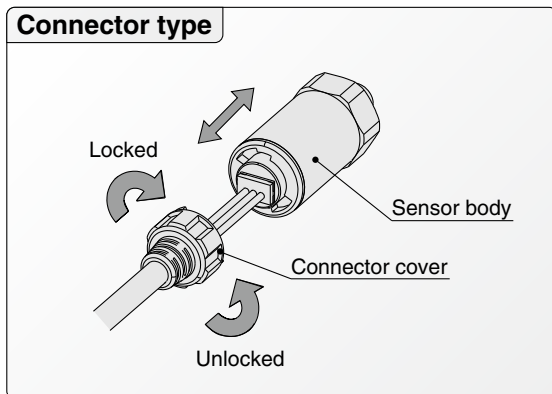

Application example

Leak test of radiator
PSE532 + PSE300A Series

Low pressure sensor (PSE532-□) is used to detect minute differentiations. Auto-shift function reduces influence of fluctuations in the supply pressure.

Applications

Pressure Sensor **PSE530 Series**



How to Order

PSE53 0 - M5 -

• **Sensor range**

0	Positive pressure [0 to 1 MPa]
1	Vacuum [0 to -101 kPa]
2	Low pressure [0 to 101 kPa]
3	Compound pressure [-101 to 101 kPa]

• **Port size**

M5	M5 x 0.8
R06	ø6 reducer
R07	1/4 inch reducer

• **Option**

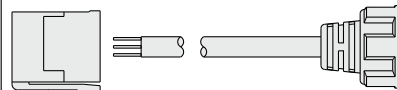
Nil	None
L	Sensor cable (3 m) 
C2L	Connector for pressure sensor controller (1 pc.) + Sensor cable (3 m) 

* The connector is not attached to the cable, but is included with the shipment.

Options/Part Nos.

When only optional parts are required, order with the part numbers listed below.

Description	Part no.	Note
Connector for pressure sensor controller	ZS-28-C	1 pc. per set
Sensor cable	ZS-26-F	Cable length: 3 m
Connector for pressure sensor controller + Sensor cable	ZS-26-J	Cable length: 3 m The connector is not attached to the cable at the time of shipment.

For pressure switch precautions and specific product precautions, refer to the "Operation Manual" on the SMC website.

Specifications

Model	PSE530 (Positive pressure)	PSE531 (Vacuum)	PSE532 (Low pressure)	PSE533 (Compound pressure)
Rated pressure range	0 to 1 MPa	0 to -101 kPa	0 to 101 kPa	-101 to 101 kPa
Extension analog output range	-0.1 to 0 MPa	10.1 to 0 kPa	-10.1 to 0 kPa	—
Proof pressure	1.5 MPa		500 kPa	
Applicable fluid	Air/Non-corrosive gas/Non-flammable gas			
Power supply voltage	12 to 24 VDC ±10%, Ripple (p-p) 10% or less (with reverse connection protection)			
Current consumption	15 mA or less (with no load)			
Output specifications	Analog output 1 to 5 V (within rated pressure range), 0.6 to 1 V (within extension analog output range), Output impedance: Approx. 1 kΩ			
Accuracy (Ambient temperature at 25°C)	±2% F.S. (within rated pressure range), ±5% F.S. (within extension analog output range)			
Linearity	±1% F.S.			
Repeatability	±1% F.S.			
Power supply voltage effect	±1% F.S. based on the analog output at 18 V ranging from 12 to 24 VDC			
Environment	Enclosure	IP40		
	Temperature range	Operating: 0 to 50°C; Stored: -10 to 70°C (No freezing or condensation)		
	Withstand voltage	1000 VAC (in 50/60 Hz) for 1 min between terminals and housing		
	Insulation resistance	5 MΩ or more (500 VDC measured via megohmmeter) between terminals and housing		
Temperature characteristics	±2% F.S. (25°C reference)			
Sensor cable/Option	Halogen-free heavy-duty cable, 3 cores, ø2.7, 3 m, Conductor area: 0.15 mm ² , Insulator O.D.: 0.8 mm			
Standards	CE/UKCA marking			

Piping Specifications

Part no.	M5	R06	R07
Port size	M5 x 0.8 male thread	ø6 reducer type	1/4 inch reducer type
Materials of parts in contact with fluid	Pressure sensor: Silicon, O-ring: NBR		
	Body: Stainless steel 304	Body: PBT	
Weight	With sensor cable (3 m)	41 g	38 g
	Without sensor cable	7 g	3.8 g

PSE530
 PSE540
 PSE550
 PSE560
 PSE570
 PSE200A
 PSE300A
 PSE300AC
 Digital Sensor Monitors

PSE530 Series

Internal Circuit and Wiring Example

PSE53 □
 Voltage output type
 1 to 5 V
 Output impedance
 Approx. 1 kΩ

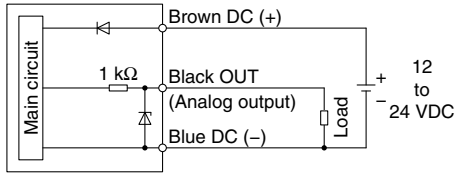

Analog Output

1 to 5 VDC

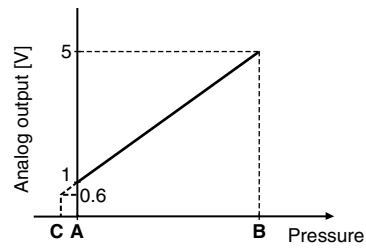

Range	Rated pressure range	A	B	C
For vacuum	0 to -101 kPa	0	-101 kPa	10.1 kPa
For compound pressure	-101 kPa to 101 kPa	-101 kPa	101 kPa	—
For low pressure	0 to 101 kPa	0	101 kPa	-10.1 kPa
For positive pressure	0 to 1 MPa	0	1 MPa	-0.1 MPa

Dimensions

PSE53 □-M5

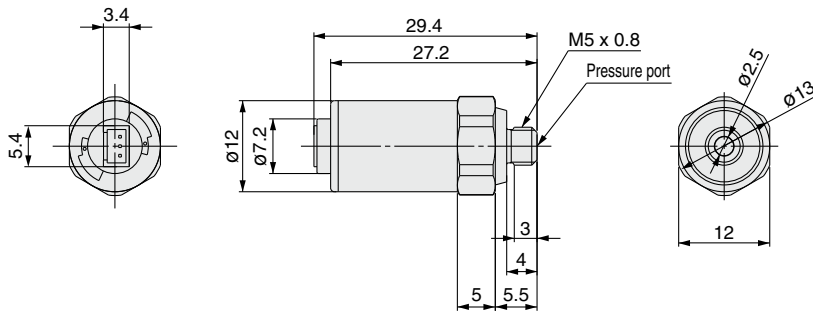

PSE53 □-R06 R07

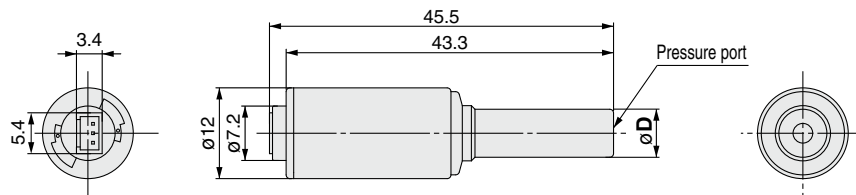

[mm]

Model	Applicable fitting size (D)
PSE53 □-R06	6
PSE53 □-R07	1/4"

With sensor cable

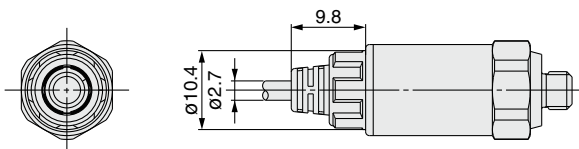

Digital Sensor Monitors
PSE300AC PSE300A PSE200A

PSE570

PSE560

PSE550

PSE540

PSE530

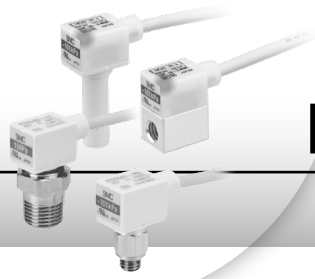

Compact Pneumatic Pressure Sensor/Switch

PSE540 Series



Series	Rated pressure range				
	-100 kPa	0	100 kPa	500 kPa	1 MPa
PSE540		0	1 MPa		
PSE541	-101 kPa	0			
PSE543	-100 kPa		100 kPa		

- Weight: 2.9 g
- Head size: 9.6 x 20.8 x 18 mm

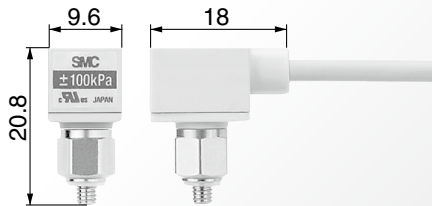

For PSE54□-M3

Application examples

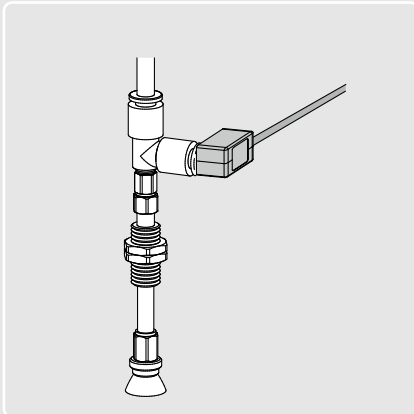

Pads can be directly mounted.

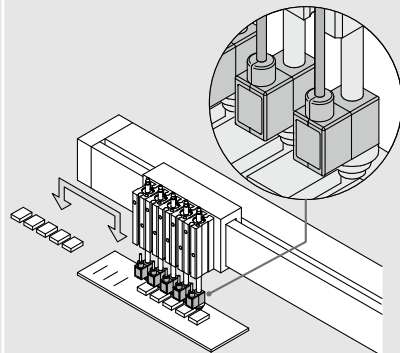

Manifolding is possible.

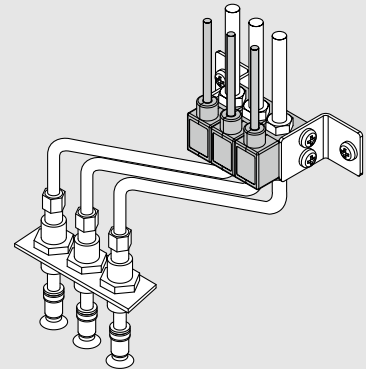

Applications

Compact Pneumatic Pressure Sensor/Switch



PSE540 Series



Analog output type

IO-Link / 1-output type ▶ p. 11

How to Order

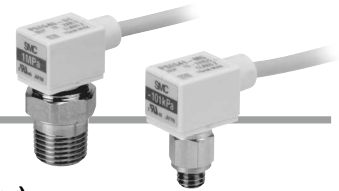

Sensor range	
0	Positive pressure [0 to 1 MPa]
1	Negative pressure [0 to -101 kPa]
3	Compound pressure [-100 to 100 kPa]

Accuracy	
Nil	±2% F.S.
A	±1% F.S.

Option (Connector)

Option (Connector)	
Nil	None
C2	Connector for pressure sensor controller (1 pc.)

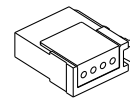

* The connector is not attached to the cable, but is included with the shipment.

PSE54 1 - M3 -

Port size

M3	M3 x 0.5		IM5	M5 female thread, through type	
M5	M5 x 0.8		IM5H	M5 female thread, through type (with mounting hole)	
01	R1/8 (with M5 female thread)				
N01	NPT1/8 (with M5 female thread)				
R04	ø4 reducer				
R06	ø6 reducer				

Option/Part No.

Description	Part no.	Note
Connector for pressure sensor controller	ZS-28-C	1 pc.

Specifications

For pressure switch precautions and specific product precautions, refer to the "Operation Manual" on the SMC website.

Model	PSE540	PSE541	PSE543
Rated pressure range	0 to 1 MPa	0 to -101 kPa	-100 to 100 kPa
Extension analog output range	-0.1 to 0 MPa	10.1 to 0 kPa	—
Proof pressure	1.5 MPa	500 kPa	
Applicable fluid	Air/Non-corrosive gas/Non-flammable gas		
Power supply voltage	12 to 24 VDC ±10%, Ripple (p-p) 10% or less (with reverse connection protection)		
Current consumption	15 mA or less		
Output specifications	Analog output 1 to 5 V (within rated pressure range), 0.6 to 1 V (within extension analog output range), Output impedance: Approx. 1 kΩ		
Accuracy (Ambient temperature at 25°C)	PSE54□: ±2% F.S. (within rated pressure range), ±5% F.S. (within extension analog output range) PSE54□A: ±1% F.S. (within rated pressure range), ±3% F.S. (within extension analog output range)		
Linearity	±0.7% F.S. or less	±0.4% F.S.	
Repeatability	±0.2% F.S.		
Power supply voltage effect	±0.8% F.S.		
Environment	Enclosure	IP40	
	Operating temperature range	Operating: 0 to 50°C, Stored: -20 to 70°C (No freezing or condensation)	
	Operating humidity range	Operating/Stored: 35 to 85% RH (No condensation)	
	Withstand voltage	1000 VAC (in 50/60 Hz) for 1 min between terminals and housing	
	Insulation resistance	50 MΩ or more (500 VDC measured via megohmmeter) between terminals and housing	
Temperature characteristics	±2% F.S. (25°C reference)		
Sensor cable	Oilproof heavy-duty vinyl cable (ellipse), 3 cores, 2.7 x 3.2, 3 m, Conductor area: 0.15 mm ² , Insulator O.D.: 0.9 mm		
Standards	CE/UKCA marking, UL/CSA (E216656)		

Piping Specifications

Part no.	M3	M5	01	N01	R04	R06	IM5	IM5H
Port size	M3 x 0.5	M5 x 0.8	R1/8 M5 x 0.8	NPT1/8 M5 x 0.8	ø4 reducer	ø6 reducer	M5 female thread, through type	M5 female thread, through type (with mounting hole)
Material	Case	Resin case: PBT Fitting: Stainless steel 303		Resin case: PBT Fitting: C3604BD		PBT		Resin case: PBT Fitting: A6063S-T5
	Pressure sensing section	Pressure sensor: Silicon, O-ring: NBR						
Weight	With sensor cable	42.4 g	42.7 g	49.3 g	41.4 g	41.6 g	43.3 g	44.1 g
	Without sensor cable	2.9 g	3.2 g	9.8 g	1.9 g	2.1 g	3.8 g	4.6 g

Compact Pneumatic Pressure Sensor/Switch



PSE540 Series



IO-Link / 1-output type

Analog output type ▶ p. 10

How to Order

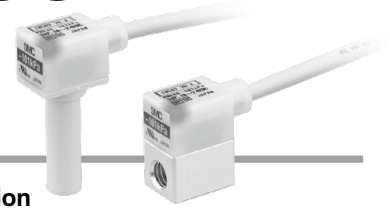

Sensor range		Accuracy		Output specification	
0	Positive pressure [0 to 1 MPa]	Nil	±2% F.S.	L	IO-Link/Switch: 1 output (PNP or NPN switching type for switch output)
1	Negative pressure [0 to -101 kPa]	A	±1% F.S.		
3	Compound pressure [-100 to 100 kPa]				

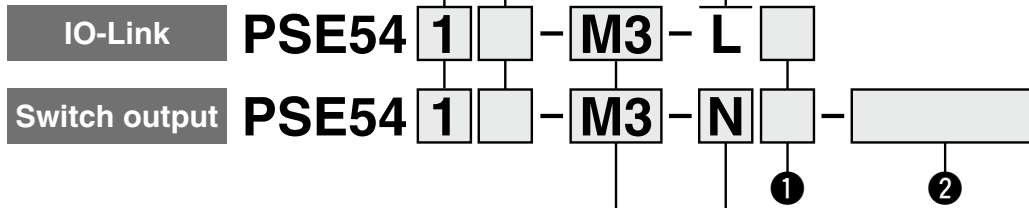

Port size

M3	M3 x 0.5		IM5	M5 female thread, through type	
M5	M5 x 0.8		IM5H	M5 female thread, through type (with mounting hole)	
01	R1/8 (with M5 female thread)				
N01	NPT1/8 (with M5 female thread)				
R04	ø4 reducer				
R06	ø6 reducer				

Output specification	
N	NPN open collector 1 output
P	PNP open collector 1 output

① Lead wire termination

Nil	Basic	
S	With M12-4 pin connector, 500 mm	

② Set value (When output specification "N" or "P" is selected)

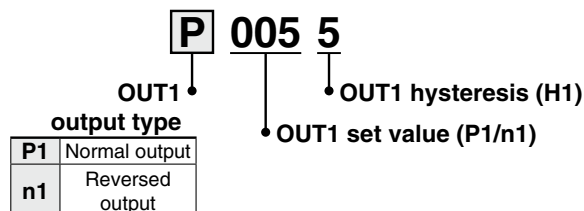

Normal output

Switch output

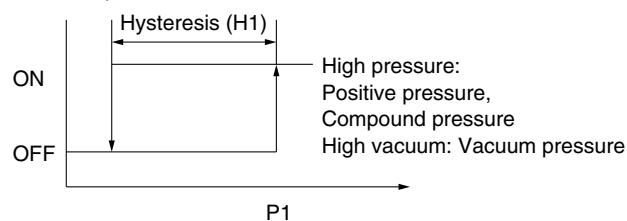

Reversed output

Switch output

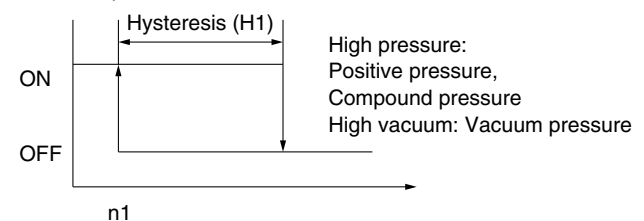

OUT1 set value (P1/n1)

Symbol	Sensor range		
	PSE540	PSE541	PSE543
-10	/	/	-100 kPa*1
-09			-90 kPa
-08			-80 kPa
-07			-70 kPa
-06			-60 kPa
-05			-50 kPa
-04			-40 kPa
-03			-30 kPa
-02			-20 kPa
-01			-0.1 MPa*1
000	0.0 MPa	0 kPa	0 kPa
001	0.1 MPa	-10 kPa	10 kPa
002	0.2 MPa	-20 kPa	20 kPa
003	0.3 MPa	-30 kPa	30 kPa
004	0.4 MPa	-40 kPa	40 kPa
005	0.5 MPa	-50 kPa	50 kPa
006	0.6 MPa	-60 kPa	60 kPa
007	0.7 MPa	-70 kPa	70 kPa
008	0.8 MPa	-80 kPa	80 kPa
009	0.9 MPa	-90 kPa	90 kPa
010	1.0 MPa*1	-100 kPa*1	100 kPa*1

OUT1 hysteresis (H1)

Symbol	Sensor range		
	PSE540	PSE541	PSE543
0	0.00 MPa	0 kPa	0 kPa
1	0.01 MPa	1 kPa	1 kPa
2	0.02 MPa	2 kPa	2 kPa
3	0.03 MPa	3 kPa	3 kPa
4	0.04 MPa	4 kPa	4 kPa
5	0.05 MPa	5 kPa	5 kPa
6	0.06 MPa	6 kPa	6 kPa
7	0.07 MPa	7 kPa	7 kPa
8	0.08 MPa	8 kPa	8 kPa
9	0.09 MPa	9 kPa	9 kPa
A	0.10 MPa	10 kPa	10 kPa

- *1 Part numbers whose switch output switching point is out of the set pressure range cannot be selected.
 Normal output: $P1 - H1 \geq \text{set pressure range lower limit}$
 Reverse output: $n1 + H1 \leq \text{set pressure range upper limit}$
 Be sure to confirm the above.
- *2 If you wish to use a set value other than the above, contact your local SMC sales representative.

Ordering Example

- Pressure range: Positive pressure
- Port size: M3
- Accuracy: $\pm 2\%$ F.S.
- Output specification: NPN open collector 1 output
- Lead wire termination: With M12-4 pin connector
- OUT1: Normal output, Set point 0.5 MPa, Hysteresis 0.05 MPa

PSE540-M3-NS-P0055

PSE530

PSE540

PSE550

PSE560

PSE570

PSE200A

PSE300A

PSE300AC

Digital Sensor Monitors

PSE540 Series

For pressure switch precautions and specific product precautions, refer to the "Operation Manual" on the SMC website.

Specifications

Model	IO-Link		
	PSE540(A)-□-L	PSE541(A)-□-L	PSE543(A)-□-L
Rated pressure range	-0.1 to 1 MPa	0 to -101 kPa	-100 to 100 kPa
Set pressure range	-0.105 to 1.05 MPa	10 to -105 kPa	-105 to 105 kPa
Smallest settable increment	1 kPa	0.1 kPa	0.1 kPa
Proof pressure	1.5 MPa	500 kPa	
Applicable fluid	Air/Non-corrosive gas/Non-flammable gas		
Power supply voltage	When used as a switch output device (When not used as an IO-Link device)	12 to 24 VDC ±10%, Ripple (p-p) 10% or less	
	When used as an IO-Link device	18 to 26.4 VDC, including ripple (p-p) 10%	
Current consumption	35 mA or less		
Output	NPN or PNP open collector 1 output (Selectable) Hysteresis, Window comparator, Error output Normal, Reversed Max. load current: 80 mA Max. applied voltage: 30 V Internal voltage drop (Residual voltage): 1.5 V or less (at load current of 80 mA) Delay time: 3.4 ms or less, Variable from 0 to 60 s/0.01 s increments		
Accuracy (Ambient temperature at 25°C)	PSE54□A: ±1% F.S. (within rated pressure range), ±3% F.S. (within extension analog output range) PSE54□: ±2% F.S. (within rated pressure range), ±5% F.S. (within extension analog output range)		
Linearity	±0.7% F.S.	±0.4% F.S.	
Repeatability	±0.2% F.S.		
Power supply voltage effect	±0.8% F.S.		
Environment	Enclosure	IP40	
	Operating temperature range	Operating: 0 to 50°C, Stored: -10 to 60°C (No freezing or condensation)	
	Operating humidity range	Operating/Stored: 35 to 85% RH (No condensation)	
	Withstand voltage	1000 VAC (in 50/60 Hz) for 1 min between terminals and housing	
	Insulation resistance	50 MΩ or more (500 VDC measured via megohmmeter) between terminals and housing	
Temperature characteristics	±2% F.S. (25°C reference)		
Sensor cable	Oilproof heavy-duty vinyl cable (ellipse), 3 cores, 2.7 x 3.2, 3 m, Conductor area: 0.15 mm ² , Insulator O.D.: 0.9 mm		
Standards	CE/UKCA marking, UL/CSA (E216656)		
Communication	IO-Link type	Device	
	IO-Link version	V1.1	
	Communication speed	COM2 (38.4 kbps)	
	Configuration file	IODD file	
	Min. cycle time	3.4 ms	
	Process data length	Input data: 4 bytes, Output data: 0 bytes	
	On request data communication	Yes	
	Data storage function	Yes	
	Event function	Yes	
	Vendor ID	131 (0 x 0083)	
Indicator light	SIO mode: Lights up when switch output is turned ON (OUT1: Red) IO-Link communication: ON or flashing (OUT1: Red)		

Compact Pneumatic Pressure Sensor/Switch **PSE540 Series**

For pressure switch precautions and specific product precautions, refer to the "Operation Manual" on the SMC website.

Specifications

Model	Switch output		
	PSE540(A)-□-N/P	PSE541(A)-□-N/P	PSE543(A)-□-N/P
Rated pressure range	-0.1 to 1 MPa	0 to -101 kPa	-100 to 100 kPa
Set pressure range	-0.105 to 1.05 MPa	10 to -105 kPa	-105 to 105 kPa
Smallest settable increment	1 kPa		
Proof pressure	1.5 MPa	500 kPa	
Applicable fluid	Air/Non-corrosive gas/Non-flammable gas		
Power supply voltage	12 to 24 VDC ±10%, Ripple (p-p) 10% or less		
Current consumption	35 mA or less		
Output	NPN or PNP open collector 1 output Hysteresis Normal, Reversed Max. load current: 80 mA Max. applied voltage: 30 V Internal voltage drop (Residual voltage): 1.5 V or less (at load current of 80 mA) Delay time: 3.4 ms or less		
Accuracy (Ambient temperature at 25°C)	PSE54□A: ±1% F.S. (within rated pressure range), ±3% F.S. (within extension analog output range) PSE54□: ±2% F.S. (within rated pressure range), ±5% F.S. (within extension analog output range)		
Linearity	±0.7% F.S.	±0.4% F.S.	
Repeatability	±0.2% F.S.		
Power supply voltage effect	±0.8% F.S.		
Environment	Enclosure	IP40	
	Operating temperature range	Operating: 0 to 50°C, Stored: -10 to 60°C (No freezing or condensation)	
	Operating humidity range	Operating/Stored: 35 to 85% RH (No condensation)	
	Withstand voltage	1000 VAC (in 50/60 Hz) for 1 min between terminals and housing	
Insulation resistance	50 MΩ or more (500 VDC measured via megohmmeter) between terminals and housing		
Temperature characteristics	±2% F.S. (25°C reference)		
Sensor cable	Oilproof heavy-duty vinyl cable (ellipse), 3 cores, 2.7 x 3.2, 3 m, Conductor area: 0.15 mm ² , Insulator O.D.: 0.9 mm		
Standards	CE/UKCA marking, UL/CSA (E216656)		

Piping Specifications

Part no.		M3	M5	01	N01	R04	R06	IM5	IM5H
Port size		M3 x 0.5	M5 x 0.8	R1/8 M5 x 0.8	NPT1/8 M5 x 0.8	ø4 reducer	ø6 reducer	M5 female thread, through type	M5 female thread, through type (with mounting hole)
Material	Case	Resin case: PC Fitting: Stainless steel 303		Resin case: PC Fitting: C3604BD		Resin case: PC		Resin case: PC Fitting: A6063S-T5	
	Pressure sensing section	Pressure sensor: Silicon, O-ring: NBR							
Weight	With sensor cable	43.6 g	43.9 g	50.5 g	42.6 g	42.8 g	44.5 g	45.3 g	
	Without sensor cable	4.1 g	4.4 g	11 g	3.1 g	3.3 g	5.0 g	5.8 g	

PSE530

PSE540

PSE550

PSE560

PSE570

PSE200A

PSE300A

PSE300AC

Digital Sensor Monitors

PSE540 Series

Internal Circuit and Wiring Example

PSE54 □
 Voltage output type
 1 to 5 V
 Output impedance
 Approx. 1 kΩ

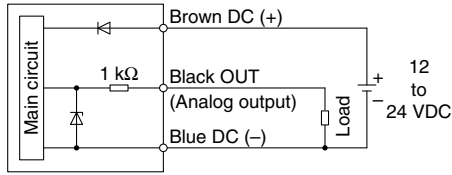

Analog Output

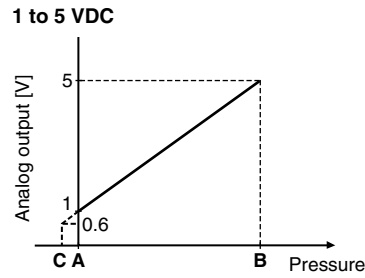

Range	Rated pressure range	A	B	C
For vacuum	0 to -101 kPa	0	-101 kPa	10.1 kPa
For compound pressure	-100 kPa to 100 kPa	-100 kPa	100 kPa	—
For positive pressure	0 to 1 MPa	0	1 MPa	-0.1 MPa

-N NPN (1 output)

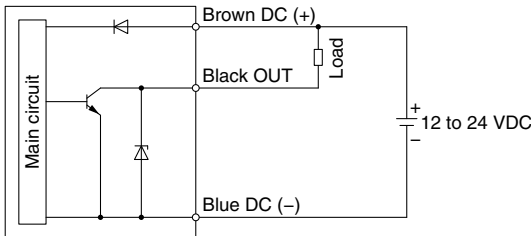

-P PNP (1 output)

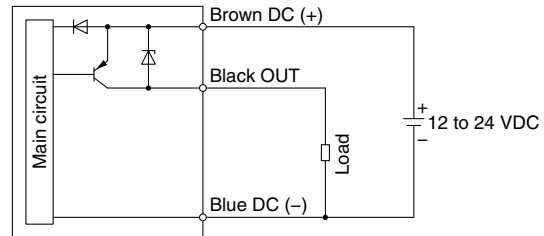

-L: (IO-Link/Switch 1 output)

When used as a switch output device (When not used as an IO-Link device = When in SIO mode)

NPN open collector 1 output setting

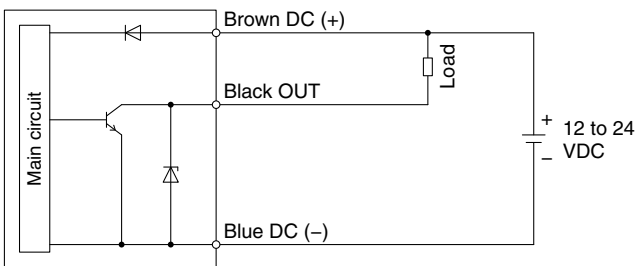

PNP open collector 1 output setting

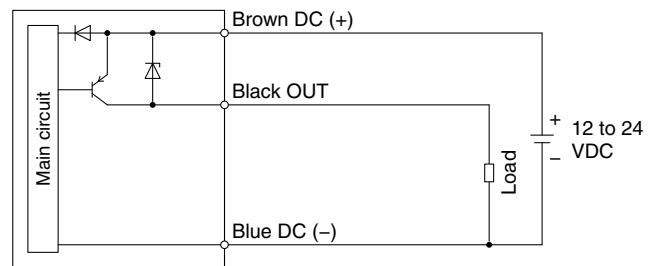

When used as an IO-Link device

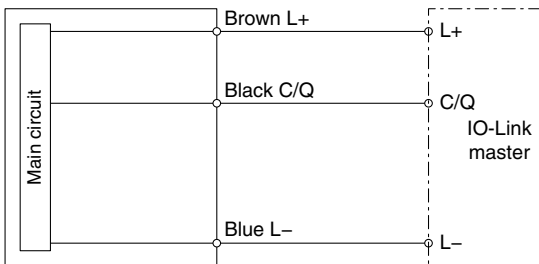

IO-Link: Process Data

Relationship between the process data and pressure value

PSE540-L (For positive pressure)

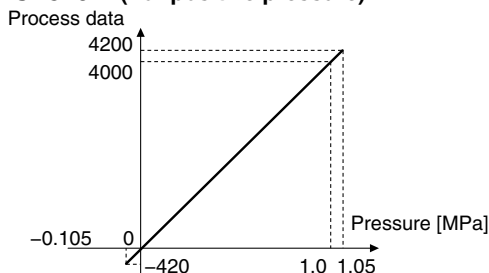

PSE541-L (For negative pressure)

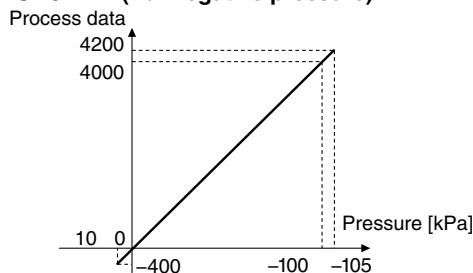

PSE543-L (For compound pressure)

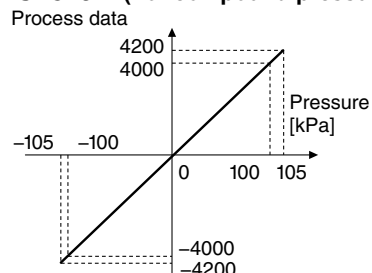

Dimensions

PSE54□-M3
M5

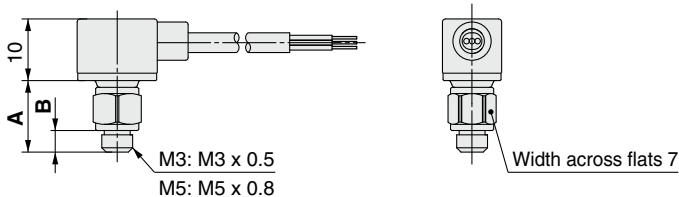

	PSE54□-M3	PSE54□-M5
A	10.8	11.5
B	3	3.5

PSE54□-R04
R06

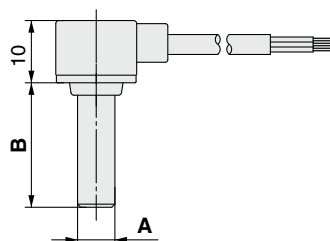

	PSE54□-R04	PSE54□-R06
A	ø4	ø6
B	18	20

Common Dimensions

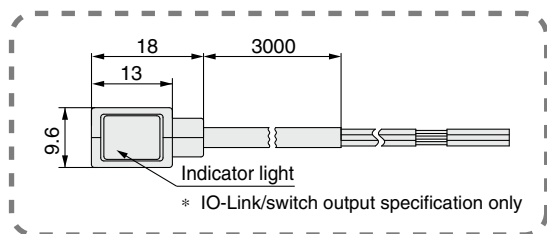

PSE54□-IM5

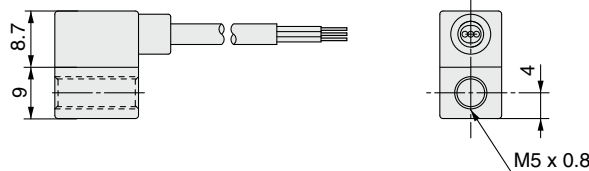

PSE54□-01
N01

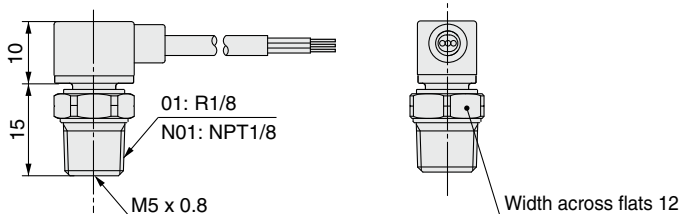

PSE54□-IM5H

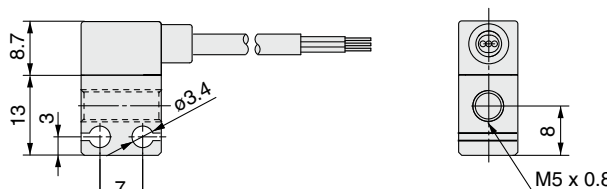

PSE530
 PSE540
 PSE550
 PSE560
 PSE570
 PSE200A
 PSE300A
 PSE300AC
 Digital Sensor Monitors



Low Differential Pressure Sensor

PSE550 Series



Series	Rated pressure range		
	0	1 kPa	2 kPa
PSE550	0	2 kPa	

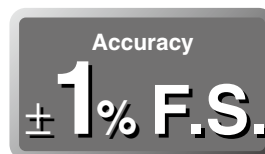
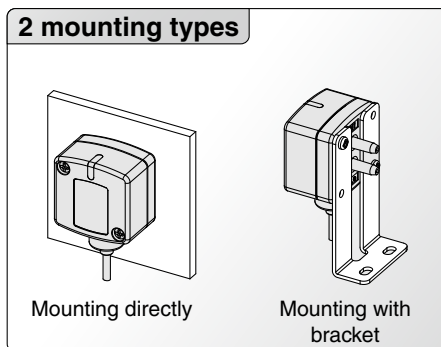
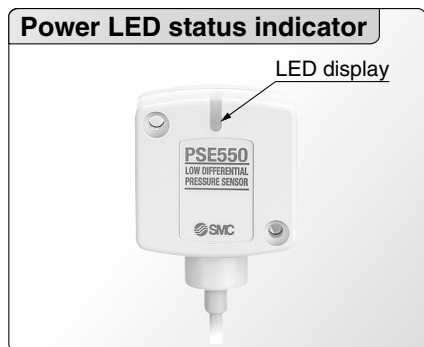

Application examples

Flow control
PSE550 Series

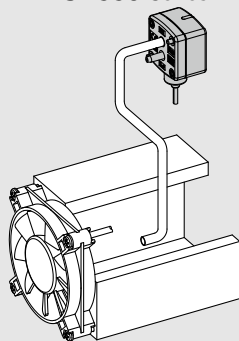

Can control air flow by monitoring the flow rate inside the duct.

Filter clogging monitoring
PSE550 Series

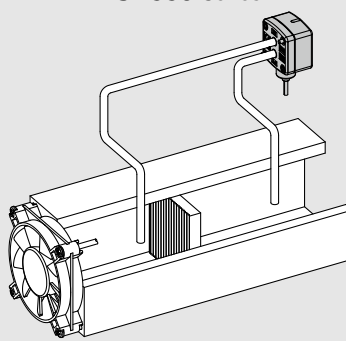

Can control filtration and replacement periods by monitoring the clogging of the filter.

Liquid level detection
PSE550 Series

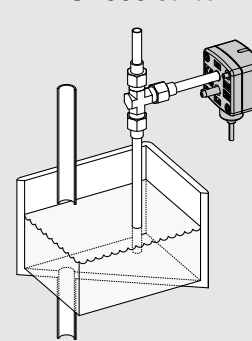

Can detect the liquid level through changes in the purge pressure.

Applications

Low Differential Pressure Sensor

PSE550 Series



How to Order

PSE550-□-□-□

Output specifications

Nil	Voltage output type 1 to 5 V
28	Current output type 4 to 20 mA

Option 2 (Connector)

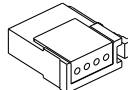
Nil	None
C2	Connector for pressure sensor controller (1 pc.) 

- * Not applicable to the PSE200 series.
- * The connector is not attached to the cable, but is included with the shipment.

Option 1 (Bracket)

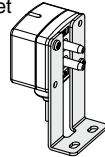
Nil	None
A	Bracket 

- * The bracket is not attached to the product, but is included with the shipment.

Options/Part Nos.

Description	Part no.	Note
Bracket	ZS-30-A	With M3 x 5 L (2 pcs.)
Connector for pressure sensor controller	ZS-28-C	1 pc.

Specifications

For pressure switch precautions and specific product precautions, refer to the "Operation Manual" on the SMC website.

Model	PSE550	PSE550-28
Rated differential pressure range	0 to 2 kPa	
Operating pressure range	-50 to 50 kPa*1	
Extension analog output range	-0.2 to 0 kPa	—
Proof pressure	65 kPa	
Applicable fluid	Air/Non-corrosive gas/Non-flammable gas	
Power supply voltage	12 to 24 VDC ±10%, Ripple (p-p) 10% or less (with reverse connection protection)	
Current consumption	15 mA or less	—
Output specifications	Analog output: 1 to 5 VDC (within rated differential pressure range) 0.6 to 1 VDC (within extension analog output range) Output impedance: Approx. 1 kΩ	Analog output: 4 to 20 mA DC (within rated differential pressure range) Maximum load impedance: 500 Ω or less (at 24 VDC) 100 Ω or less (at 12 VDC)
Accuracy (Operating temperature at 25°C)	±1% F.S. (within rated differential pressure range), ±3% F.S. (within extension analog output range)	
Linearity	±0.5% F.S.	
Repeatability	±0.3% F.S.	
Indicator light	Orange light is turned on. (When energized)	
Environment	Enclosure	IP40
	Operating temperature range	Operating: 0 to 50°C, Stored: -20 to 70°C (No freezing or condensation)
	Operating humidity range	Operating/Stored: 35 to 85% RH (No condensation)
	Withstand voltage	1000 VAC (in 50/60 Hz) for 1 min between terminals and housing
Insulation resistance	50 MΩ or more (500 VDC measured via megohmmeter) between terminals and housing	
Temperature characteristics	±3% F.S. (25°C reference)	
Port size	ø4.8 (ø4.4 in the end) resin piping (Applicable to I.D. ø4 air tubing)	
Materials of parts in contact with fluid	Resin pipe: Nylon, Piston area of sensor: Silicon	
Sensor cable	Oilproof heavy-duty vinyl cable (ellipse), 3 cores, ø2.6, 3 m Conductor area: 0.15 mm ² , Insulator O.D.: 0.9 mm	Oilproof heavy-duty vinyl cable (ellipse), 2 cores, ø2.6, 3 m Conductor area: 0.15 mm ² , Insulator O.D.: 0.9 mm
Weight	With sensor cable	75 g
	Without sensor cable	35 g
Standards	CE/UKCA marking, UL/CSA (E216656)	

*1 Can detect differential pressure from 0 to 2 kPa within the range of -50 to 50 kPa.

PSE530

PSE540

PSE550

PSE560

PSE570

PSE200A

PSE300A

PSE300AC

Digital Sensor Monitors

PSE550 Series

Internal Circuits and Wiring Examples

PSE550

Voltage output type
1 to 5 V
Output impedance
Approx. 1 k Ω

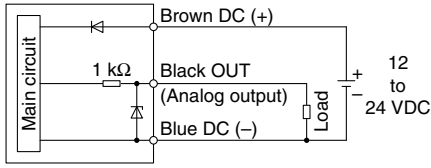

PSE550-28

Current output type
4 to 20 mA
Allowable load impedance
500 Ω or less (at 24 VDC)
100 Ω or less (at 12 VDC)

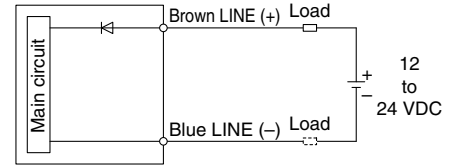

* Install the load either on the LINE (+) or LINE (-) side.

Analog Output

1 to 5 VDC

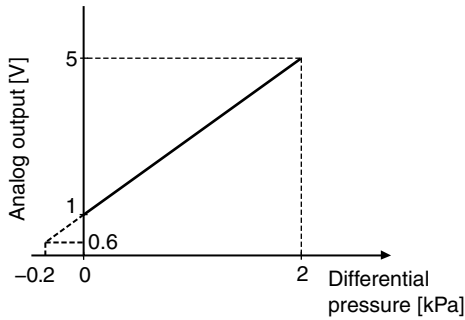

4 to 20 mA DC

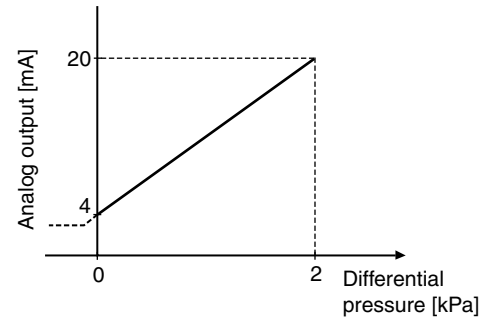

Dimensions

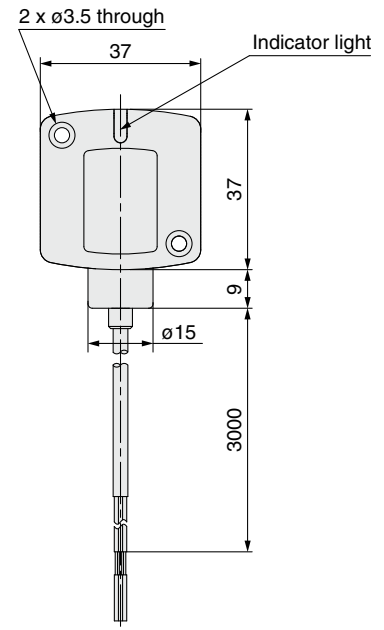
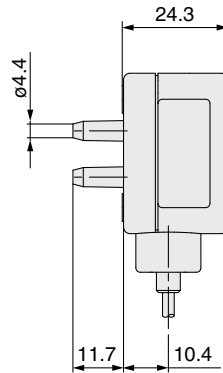
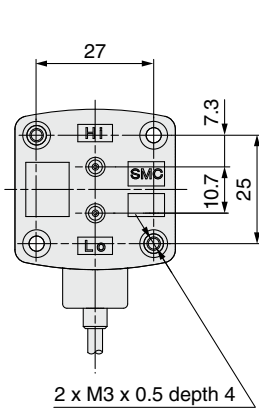

With bracket

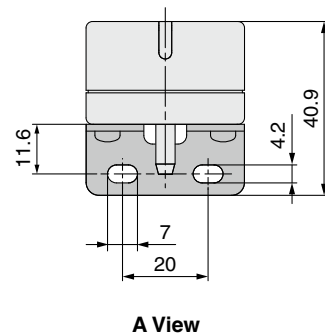
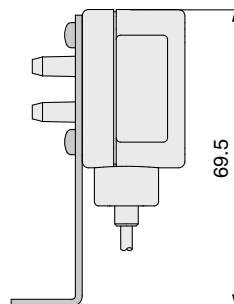
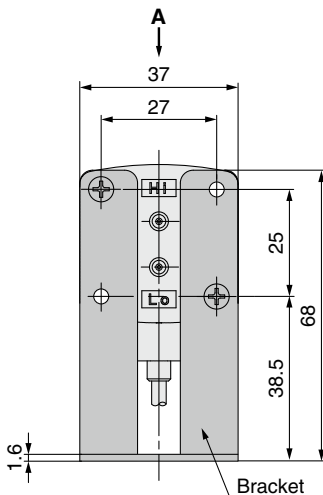



Pressure Sensor for General Fluids

PSE560 Series



PSE530

PSE540

PSE550

PSE560

PSE570

PSE200A

PSE300A

PSE300AC

Digital Sensor Monitors

Series	Rated pressure range				
	-100 kPa	0	100 kPa	500 kPa	1 MPa
PSE560		0	1 MPa		
PSE561	-101 kPa	0			
PSE563	-100 kPa		100 kPa		
PSE564		0		500 kPa	

Applicable fluid examples

- Argon
- Air-containing drainage
- Refrigerant
- Nitrogen
- Hydraulic oil
- Silicone oil
- Water
- Carbon dioxide
- Lubricant
- Fluorocarbon
- Air

Material of parts
in contact with fluid
Stainless steel 316L

IP65

**Copper-free
Fluorine-free**

Oil-free
(Single diaphragm construction)

Variations

Port type	Thread type	Special fitting type for semiconductors
Port size	R1/8, R1/4, Rc1/8, NPT1/8, NPT1/4	URJ1/4, TSJ1/4*1
Leakage	$1 \times 10^{-5} \text{Pa} \cdot \text{m}^3/\text{s}$	$1 \times 10^{-10} \text{Pa} \cdot \text{m}^3/\text{s}$
Analog output	1 to 5 V voltage output	
	4 to 20 mA current output	

*1 For URJ1/4, TSJ1/4, refer to "Glossary of Terms/Technical Information" in the Web Catalog.

Application examples

Cleaning lines

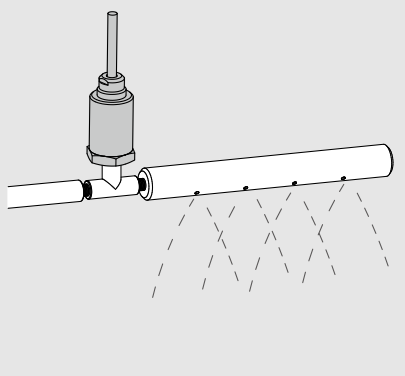

Check for working pressure for hydraulic cylinders

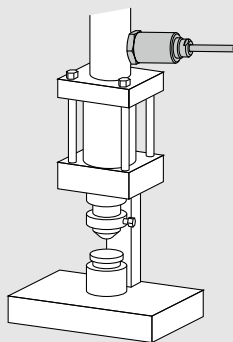

Suction verification of workpieces containing moisture

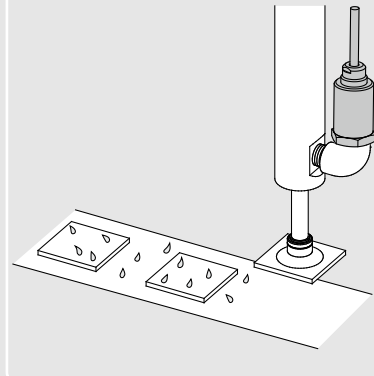

* When vacuum is released, take precautions to avoid water hammer. (An adapter with restrictor (ZS-31-X175) is available to prevent water hammer.) (Refer to "NOTE" in the Operation Manual on the SMC website for details.)

Applications

Pressure Sensor for General Fluids

PSE560 Series



How to Order

Sensor range

0	Positive pressure [0 to 1 MPa]
1	Vacuum [0 to -101 kPa]
3	Compound pressure [-100 to 100 kPa]
4	Positive pressure [0 to 500 kPa]

Option (Connector)

Nil	None
C2	Connector for pressure sensor controller (1 pc.)

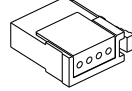

* Current output type cannot be connected to the PSE200 series.
* The connector is not attached to the cable, but is included with the shipment.

PSE56 0 - 01 - [] - []

Port size

01	R1/8 (with M5 female thread)
02	R1/4 (with M5 female thread)
C01	Rc1/8
N01	NPT1/8 (with M5 female thread)
N02	NPT1/4 (with M5 female thread)
A2	URJ1/4 (Face seal fitting)
B2	TSJ1/4 (Compression fitting)

Output specifications

Nil	Voltage output type 1 to 5 V
28	Current output type 4 to 20 mA

Options/Part Nos.

Description	Part no.	Material	Note
Connector for pressure sensor controller	ZS-28-C	—	1 pc.
Adapter with restrictor Rc1/4	ZS-31-X175	Stainless steel 304	1 pc.
Adapter with restrictor NPT1/4	ZS-31-X186		1 pc.
Adapter with restrictor Rc1/8	ZS-31-X188		1 pc.
Adapter with restrictor NPT1/8	ZS-31-X189		1 pc.
Orifice M5	ZS-48-A	Stainless steel 303	1 pc.

For pressure switch precautions and specific product precautions, refer to the "Operation Manual" on the SMC website.

Specifications

Model	PSE560 (Positive pressure)	PSE561 (Vacuum)	PSE563 (Compound pressure)	PSE564 (Positive pressure)
Rated pressure range	0 to 1 MPa	0 to -101 kPa	-100 to 100 kPa	0 to 500 kPa
Extension analog output range	-0.1 to 0 MPa	10.1 to 0 kPa	—	-50 to 0 kPa
Proof pressure	1.5 MPa	500 kPa	500 kPa	750 kPa

Model	PSE56□-□	PSE56□-□-28
Applicable fluid	Liquid or gas that will not corrode or attack stainless steel 316L	
Power supply voltage	12 to 24 VDC ±10%, Ripple (p-p) 10% or less (with reverse connection protection)	
Current consumption	10 mA or less	—
Output specifications	Analog output: 1 to 5 V (within rated pressure range) 0.6 to 1 V (within extension analog output range) Output impedance: Approx. 1 kΩ	Analog output: 4 to 20 mA DC (within rated pressure range) Maximum load impedance: 500 Ω or less (at 24 VDC) 100 Ω or less (at 12 VDC)
Accuracy (Ambient temperature at 25°C)	±1% F.S. (within rated pressure range), ±3% F.S. (within extension analog output range)	
Linearity	±0.5% F.S.	
Repeatability	±0.2% F.S.	
Power supply voltage effect	±0.3% F.S.	
Environment	Enclosure	IP65
	Operating temperature range	Operating: -10 to 60°C, Stored: -20 to 70°C (No freezing or condensation)
	Operating humidity range	Operating/Stored: 35 to 85% RH (No condensation)
	Withstand voltage	250 VAC for 1 min between terminals and housing
Insulation resistance	50 MΩ or more (50 VDC measured via megohmmeter) between terminals and housing	
Temperature characteristics	±2% F.S. (0 to 50°C: 25°C reference), ±3% F.S. (-10 to 60°C: 25°C reference)	
Sensor cable	PSE56□-□: Oilproof heavy-duty vinyl cable with air tubing, 3 cores, ø5.1, 3 m, Conductor area: 0.2 mm ² , Insulator O.D.: 1.12 mm PSE56□-□-28: Oilproof heavy-duty vinyl cable with air tubing, 2 cores, ø5.1, 3 m, Conductor area: 0.2 mm ² , Insulator O.D.: 1.12 mm	
Standards	CE/UKCA marking, UL/CSA (E216656)	

Piping Specifications

Part no.	01	02	N01	N02	C01	A2	B2	
Port size	R1/8 M5 x 0.8	R1/4 M5 x 0.8	NPT1/8 M5 x 0.8	NPT1/4 M5 x 0.8	Rc1/8	URJ1/4	TSJ1/4	
Material	Case: C3604 + Nickel plating, Piping port/Pressure sensor: Stainless steel 316L, Grease-free							
Weight	With sensor cable	193 g	200 g	194 g	201 g	187 g	203 g	193 g
	Without sensor cable	101 g	108 g	102 g	109 g	95 g	111 g	101 g

Internal Circuits and Wiring Examples

PSE56□-□
Voltage output type
1 to 5 V
Output impedance
Approx. 1 kΩ

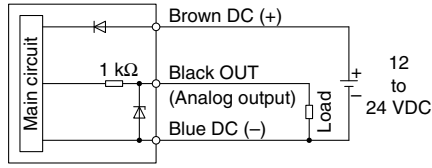

PSE56□-□-28
Current output type
4 to 20 mA
Allowable load impedance
500 Ω or less (at 24 VDC)
100 Ω or less (at 12 VDC)

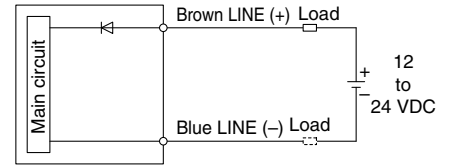

* Install the load either on the LINE (+) or LINE (-) side.

Analog Output

1 to 5 VDC

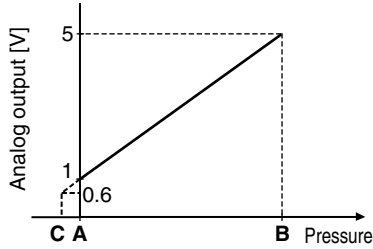

4 to 20 mA DC

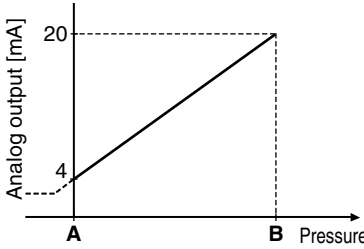

Range	Rated pressure range	A	B	C
For vacuum	0 to -101 kPa	0	-101 kPa	10.1 kPa
For compound pressure	-100 kPa to 100 kPa	-100 kPa	100 kPa	—
For positive pressure	0 to 1 MPa	0	1 MPa	-0.1 MPa
	0 to 500 kPa	0	500 kPa	-50 kPa

Dimensions

PSE56□-01, **PSE56□-N01**
PSE56□-02, **PSE56□-N02**

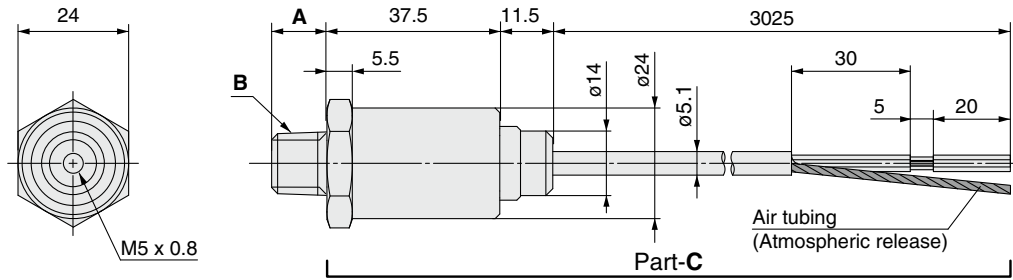

Be sure to release the air in the air tubing of the cable to the atmosphere. If the air tubing is restricted, or left in environments where it is exposed to water or oil, it cannot be detected normally.

* The dimensions of part C are common to all PSE56□ models.

PSE56□-C01

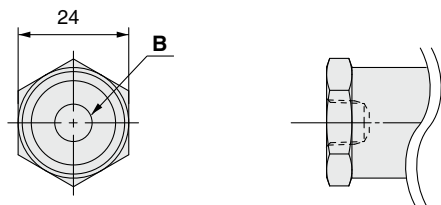

PSE56□-A2

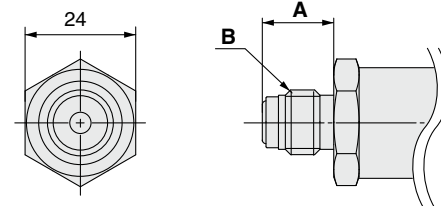

PSE56□-B2

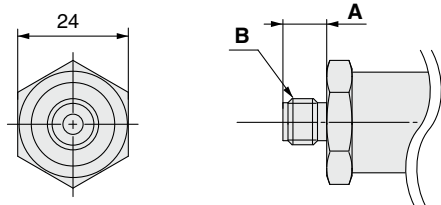

Adapter with restrictor
ZS-31-X□□□
Material:
Stainless steel 304

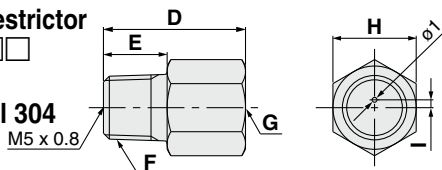

Orifice
ZS-48-A
Material:
Stainless steel 303

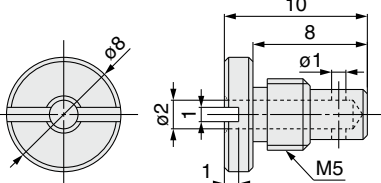

Model	A	B
PSE56□-01	8.2	R1/8
PSE56□-02	12	R1/4
PSE56□-N01	9.2	NPT1/8
PSE56□-N02	12.2	NPT1/4
PSE56□-C01	—	Rc1/8
PSE56□-A2	15.5	URJ1/4
PSE56□-B2	9.5	TSJ1/4

Part no.	D	E	F	G	H	I
ZS-31-X188	20	9	R1/8	Rc1/8	14	1.5
ZS-31-X189	20	9	NPT1/8	NPT1/8	14	1.5
ZS-31-X175	29	13	R1/4	Rc1/4	17	1.6
ZS-31-X186	29	13	NPT1/4	NPT1/4	17	1.6

* If it is expected that the pressure, such as water hammer or surge pressure, will fluctuate rapidly, refer to the precautions in the Operation Manual on the SMC website.

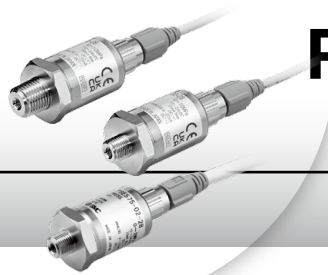

Pressure Sensor/Switch for General Fluids

PSE570 Series



(Excludes the IO-Link/2-output type)



Series	Rated pressure range						
	0	100 kPa	500 kPa	1 MPa	2 MPa	5 MPa	10 MPa
PSE570	0	1 MPa					
PSE573	-100 kPa	100 kPa					
PSE574	0	500 kPa					
PSE575	0	2 MPa					
PSE576	0	5 MPa					
PSE577	0	10 MPa					

M12 connector

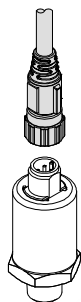

Materials of Parts in Contact with Fluid

	PSE570/573/574	PSE575/576/577
Piping port*1	C3604 + Nickel plating	
Pressure sensor*1	Al ₂ O ₃ (Alumina 96%)	
Sensor seal	FKM + Grease	FKM

*1 Stainless steel 316L is used for the PSE560.
For details, refer to page 20.

**Withstand
voltage**

500 VAC

<Twice that of the PSE560>

IP65

Application examples

Liquid coolant pressure control

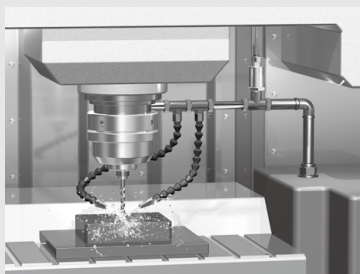

PET bottle molding machines

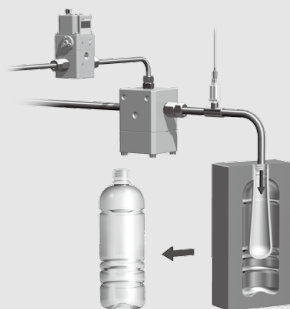

Liquid pressure control of gun drills

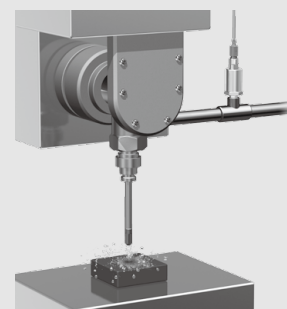

Applications

Pressure Sensor/Switch for General Fluids



PSE570 Series



Analog output type

IO-Link / 2-output type ▶ p. 25

How to Order



PSE57 0 - 01 - [] - []

Sensor range

0	Positive pressure [0 to 1 MPa]
3	Compound pressure [-100 to 100 kPa]
4	Positive pressure [0 to 500 kPa]
5	Positive pressure [0 to 2 MPa]
6	Positive pressure [0 to 5 MPa]
7	Positive pressure [0 to 10 MPa]

Option (Lead wire)

Nil	Lead wire and M12 connector (3 m), Straight	
L	Lead wire and M12 connector (3 m), Right angle	
N	None	

* See page 58 for connection to the PSE300AC.

Output specification

Nil	Voltage output type 1 to 5 V
28	Current output type 4 to 20 mA

Port size

Symbol	Port size	Model					
		PSE570	PSE573	PSE574	PSE575	PSE576	PSE577
01	R1/8 (with M5 female thread)	●	●	●	—	—	—
02	R1/4 (with M5 female thread)	●	●	●	●	●	●

Options/Part Nos.

	Description	Part no.	Material	Note
①	Lead wire and M12 connector (3 m), Straight	ZS-37-A	—	1 pc.
②	Lead wire and M12 connector (3 m), Right angle	ZS-37-B	—	1 pc.
③	Assembly-type connector	PCA-1557743	—	1 pc.
④	Adapter with restrictor Rc1/4	ZS-31-X175	Stainless steel 304	1 pc.
⑤	Adapter with restrictor Rc1/8	ZS-31-X188	—	1 pc.
⑥	Orifice M5	ZS-48-A	Stainless steel 303	1 pc.
⑦	① + ③	ZS-37-A-X448	—	The lead wire and connector are shipped together. (Not assembled)
⑧	② + ③	ZS-37-B-X449	—	
⑨	Connector for pressure sensor controller connection	ZS-28-CA-4	—	1 pc.

For pressure switch precautions and specific product precautions, refer to the "Operation Manual" on the SMC website.

Specifications

Model		PSE570	PSE573	PSE574	PSE575	PSE576	PSE577
Fluid	Applicable fluid	Gas or liquid that will not corrode materials of parts in contact with fluid					
Pressure	Rated pressure range	0 to 1 MPa	-100 to 100 kPa	0 to 500 kPa	0 to 2 MPa	0 to 5 MPa	0 to 10 MPa
	Proof pressure	3.0 MPa	600 kPa	1.5 MPa	5.0 MPa	12.5 MPa	30 MPa
	Power supply voltage	12 to 24 VDC ±10% with 10% voltage ripple or less					
Electrical	Current consumption	10 mA or less					
	Protection	Reverse connection protection					
Accuracy	Analog output accuracy (Ambient temperature at 25°C)	±1.0% F.S.			±2.5% F.S.		
	Linearity	±0.5% F.S.					
	Repeatability (Ambient temperature at 25°C)	±0.2% F.S.					
	Temperature characteristics (25°C reference)	±2% F.S. (0 to 50°C) ±3% F.S. (-10 to 60°C)	±3% F.S. (0 to 50°C) ±4% F.S. (-10 to 60°C)			±5% F.S. (-10 to 60°C)	
Environment	Enclosure	IP65					
	Withstand voltage	500 VAC for 1 min between terminals and housing					
	Insulation resistance	100 MΩ or more (500 VDC measured via megohmmeter) between terminals and housing					
	Operating temperature range	Operating: -10 to 60°C, Stored: -20 to 70°C (No freezing or condensation)					
	Operating humidity range	Operating/Stored: 35 to 85% RH (No condensation)					
Standards		CE/UKCA marking, UL/CSA (E216656)					
Materials of parts in contact with fluid		Piping port: C3604 + Nickel plating, Pressure sensor: Al ₂ O ₃ (Alumina 96%), Sensor seal: FKM + Grease			Piping port: C3604 + Nickel plating, Pressure sensor: Al ₂ O ₃ (Alumina 96%), Sensor seal: FKM		
Analog output	Model	PSE57□-□			PSE57□-□-28		
	Output	Voltage output: 1 to 5 V			Current output: 4 to 20 mA		
	Impedance	Output impedance: Approx. 1 kΩ			Maximum load impedance: 500 Ω or less (at 24 VDC) 100 Ω or less (at 12 VDC)		

PSE530

PSE540

PSE550

PSE560

PSE570

PSE200A

PSE300A

PSE300AC

Digital Sensor Monitors

Pressure Sensor/Switch for General Fluids



PSE570 Series

IO-Link / 2-output type



Analog output type ▶ p. 24

How to Order

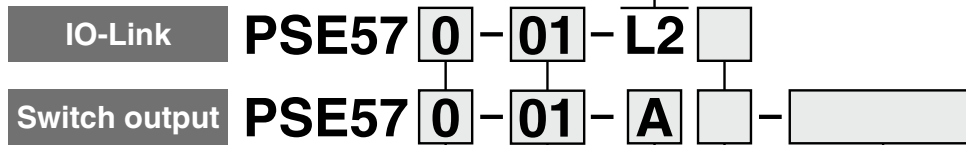

Sensor range

0	Positive pressure [0 to 1 MPa]
3	Compound pressure [-100 to 100 kPa]
4	Positive pressure [0 to 500 kPa]
5	Positive pressure [0 to 2 MPa]
6	Positive pressure [0 to 5 MPa]
7	Positive pressure [0 to 10 MPa]

Port size

Symbol	Port size	Model					
		PSE570	PSE573	PSE574	PSE575	PSE576	PSE577
01	R1/8 (with M5 female thread)	●	●	●	—	—	—
02	R1/4 (with M5 female thread)	●	●	●	●	●	●

Output specification

L2	IO-Link/Switch: 1 output + 2 outputs (PNP or NPN switching type for switch output)
----	---

Option (Lead wire)

Nil	Lead wire and M12 connector (3 m), Straight	
L	Lead wire and M12 connector (3 m), Right angle	
N	None	

Output specification

A	NPN open collector 2 outputs
B	PNP open collector 2 outputs

① Set value (When output specification "N" or "P" is selected)

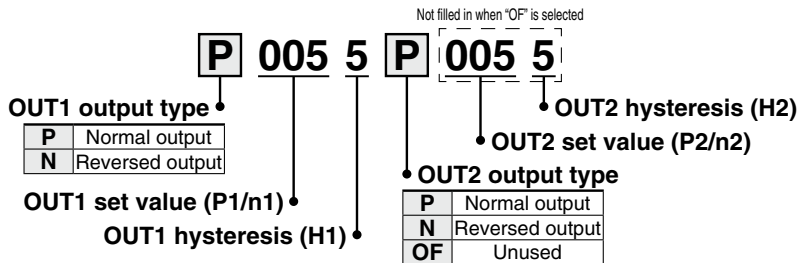

Normal output

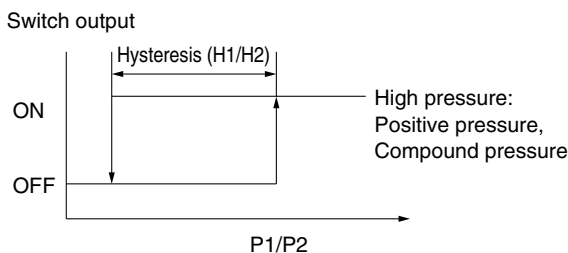

Reversed output

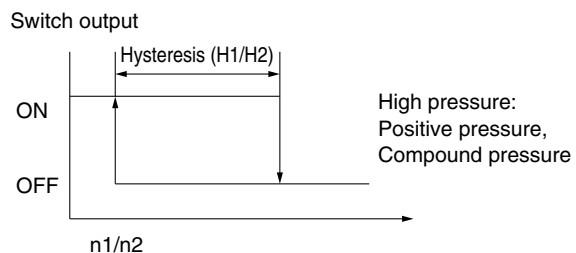

Options/Part Nos.

	Description	Part no.	Material	Note
①	Lead wire and M12 connector (3 m), Straight	ZS-37-A	—	1 pc.
②	Lead wire and M12 connector (3 m), Right angle	ZS-37-B	—	1 pc.
③	Assembly-type connector	PCA-1557743	—	1 pc.
④	Adapter with restrictor Rc1/4	ZS-31-X175	Stainless steel 304	1 pc.
⑤	Adapter with restrictor Rc1/8	ZS-31-X188	Stainless steel 304	1 pc.
⑥	Orifice M5	ZS-48-A	Stainless steel 303	1 pc.
⑦	① + ③	ZS-37-A-X448	—	The lead wire and connector are shipped together. (Not assembled)
⑧	② + ③	ZS-37-B-X449	—	

	Description	Part no.	Material	Note
⑨	Lead wire and M12 connector (Connector on both sides)	EX9-AC005-SSPS	—	Length: 0.5 m, Straight
		EX9-AC010-SSPS	—	Length: 1 m, Straight
		EX9-AC020-SSPS	—	Length: 2 m, Straight
		EX9-AC030-SSPS	—	Length: 3 m, Straight
		EX9-AC050-SSPS	—	Length: 5 m, Straight
⑩	Connector for pressure sensor controller connection	EX9-AC100-SSPS	—	Length: 10 m, Straight
		ZS-28-CA-4	—	1 pc.

* The lead wire with an M12 connector is not included with the product. Please order it separately.

OUT1 Set Value (P1/n1)

OUT2 Set Value (P2/n2)

Symbol	Sensor range					
	PSE570	PSE573	PSE574	PSE575	PSE576	PSE577
-10	/	-100 kPa*1	/	/	/	/
-09		-90 kPa				
-08		-80 kPa				
-07		-70 kPa				
-06		-60 kPa				
-05		-50 kPa				
-04		-40 kPa				
-03		-30 kPa				
-02		-20 kPa				
-01		-0.1 MPa*1				
000	0.0 MPa	0 kPa	0 kPa	0.0 MPa*1	0.0 MPa*1	0 MPa*1
001	0.1 MPa	10 kPa	50 kPa	0.2 MPa	0.5 MPa	1 MPa
002	0.2 MPa	20 kPa	100 kPa	0.4 MPa	1.0 MPa	2 MPa
003	0.3 MPa	30 kPa	150 kPa	0.6 MPa	1.5 MPa	3 MPa
004	0.4 MPa	40 kPa	200 kPa	0.8 MPa	2.0 MPa	4 MPa
005	0.5 MPa	50 kPa	250 kPa	1.0 MPa	2.5 MPa	5 MPa
006	0.6 MPa	60 kPa	300 kPa	1.2 MPa	3.0 MPa	6 MPa
007	0.7 MPa	70 kPa	350 kPa	1.4 MPa	3.5 MPa	7 MPa
008	0.8 MPa	80 kPa	400 kPa	1.6 MPa	4.0 MPa	8 MPa
009	0.9 MPa	90 kPa	450 kPa	1.8 MPa	4.5 MPa	9 MPa
010	1.0 MPa*1	100 kPa*1	500 kPa*1	2.0 MPa*1	5.0 MPa*1	10 MPa*1

OUT1 Hysteresis (H1)

OUT2 Hysteresis (H2)

Symbol	Sensor range					
	PSE570	PSE573	PSE574	PSE575	PSE576	PSE577
0	0.00 MPa	0 kPa	0 kPa	0.00 MPa	0.00 MPa	0.0 MPa
1	0.01 MPa	1 kPa	5 kPa	0.02 MPa	0.05 MPa	0.1 MPa
2	0.02 MPa	2 kPa	10 kPa	0.04 MPa	0.10 MPa	0.2 MPa
3	0.03 MPa	3 kPa	15 kPa	0.06 MPa	0.15 MPa	0.3 MPa
4	0.04 MPa	4 kPa	20 kPa	0.08 MPa	0.20 MPa	0.4 MPa
5	0.05 MPa	5 kPa	25 kPa	0.10 MPa	0.25 MPa	0.5 MPa
6	0.06 MPa	6 kPa	30 kPa	0.12 MPa	0.30 MPa	0.6 MPa
7	0.07 MPa	7 kPa	35 kPa	0.14 MPa	0.35 MPa	0.7 MPa
8	0.08 MPa	8 kPa	40 kPa	0.16 MPa	0.40 MPa	0.8 MPa
9	0.09 MPa	9 kPa	45 kPa	0.18 MPa	0.45 MPa	0.9 MPa
A	0.10 MPa	10 kPa	50 kPa	0.20 MPa	0.50 MPa	1.0 MPa

*1 Product number whose switch output switching point is out of set pressure range cannot be selected.

Normal output: $P1 - H1 \geq \text{set pressure range low limit}$

When reverse output: $n1 + H1 \leq \text{set pressure range high limit}$

Please confirm that it is.

*2 If you wish to use a set-up setting other than the above, contact your SMC sales representative

Ordering Examples

- Pressure range: PSE576
- Port size: 02
- Output specification: PNP open collector 2 outputs
- Lead wire: Lead wire and M12 connector (3 m), Right angle
- OUT1: Normal output, Set point 2.5 MPa, Hysteresis 0.05 MPa
- OUT2: Unused

PSE576-02-BL-P00510F

PSE530

PSE540

PSE550

PSE560

PSE570

PSE200A

PSE300A

PSE300AC

Digital Sensor Monitors

PSE570 Series

For pressure switch precautions and specific product precautions, refer to the "Operation Manual" on the SMC website.

Specifications

Model		IO-Link					
		PSE570-□-L2	PSE573-□-L2	PSE574-□-L2	PSE575-□-L2	PSE576-□-L2	PSE577-□-L2
Applicable fluid		Gas or liquid that will not corrode the materials of parts in contact with fluid					
Pressure	Rated pressure range	0 to 1 MPa	-100 to 100 kPa	0 to 500 kPa	0 to 2 MPa	0 to 5 MPa	0 to 10 MPa
	Set pressure range	-0.105 to 1.050 MPa	-105.0 to 105.0 kPa	-50 to 525 kPa	-0.105 to 2.1 MPa	-0.105 to 5.25 MPa	-0.105 to 10.5 MPa
	Smallest settable increment	1 kPa	0.1 kPa	1 kPa	1 kPa	10 kPa	10 kPa
	Proof pressure	3 MPa	600 kPa	1.5 MPa	5 MPa	12.5 MPa	30 MPa
Electrical	Power supply voltage	When used as a switch output device (When not used as an IO-Link device) 12 to 24 VDC ±10%, Ripple (p-p) 10% or less					
		When used as an IO-Link device 18 to 30 VDC, including ripple (p-p) 10%					
	Current consumption	35 mA or less					
Protection		Reverse connection protection					
Switch output		NPN or PNP open collector 2 outputs (Selectable) Hysteresis, Window comparator, Error output Normal, Reversed Max. load current: 80 mA Max. applied voltage: 30 V Internal voltage drop (Residual voltage): 1.5 V or less (at load current of 80 mA) Delay time: 3.4 ms or less, Variable from 0 to 60 s/0.01 s increments					
Accuracy	Accuracy (Ambient temperature at 25°C)	±1.0% F.S.			±2.5% F.S.		
	Linearity	±0.5% F.S.					
	Repeatability (Ambient temperature at 25°C)	±0.2% F.S.			±0.5% F.S.		
	Temperature characteristics	±2% F.S. (0 to 50°C) ±3% F.S. (-10 to 60°C)	±3% F.S. (0 to 50°C) ±4% F.S. (-10 to 60°C)		±5% F.S. (-10 to 60°C)		
Environment	Enclosure	IP65					
	Withstand voltage	500 VAC for 1 min between terminals and housing					
	Insulation resistance	100 MΩ or more (500 VDC measured via megohmmeter) between terminals and housing					
	Operating temperature range	Operating: -10 to 60°C, Stored: -20 to 70°C (No freezing or condensation)					
Operating humidity range		Operating/Stored: 35 to 85% RH (No condensation)					
Standards		CE/UKCA marking					
Materials of parts in contact with fluid		Piping port: C3604 + Nickel plating, Pressure sensor: Al ₂ O ₃ (Alumina 96%), Sensor seal: FKM + Grease			Piping port: C3604 + Nickel plating, Pressure sensor: Al ₂ O ₃ (Alumina 96%), Sensor seal: FKM		
Communication	IO-Link type	Device					
	IO-Link version	V1.1					
	Communication speed	COM2 (38.4 kbps)					
	Configuration file	IODD file					
	Min. cycle time	3.4 ms					
	Process data length	Input data: 4 bytes, Output data: 0 bytes					
	On request data communication	Yes					
	Data storage function	Yes					
	Event function	Yes					
	Vendor ID	131 (0 x 0083)					
Indicator light	SIO mode: Lights up when switch output is turned ON (OUT1: Green, OUT2: Red) IO-Link communication: Green light is ON or flashing. Error: Red light is flashing.						

Pressure Sensor/Switch for General Fluids **PSE570 Series**

For pressure switch precautions and specific product precautions, refer to the "Operation Manual" on the SMC website.

Specifications

Model		Switch output					
		PSE570-□-A/B	PSE573-□-A/B	PSE574-□-A/B	PSE575-□-A/B	PSE576-□-A/B	PSE577-□-A/B
Applicable fluid		Gas or liquid that will not corrode the materials of parts in contact with fluid					
Pressure	Rated pressure range	0 to 1 MPa	-100 to 100 kPa	0 to 500 kPa	0 to 2 MPa	0 to 5 MPa	0 to 10 MPa
	Set pressure range	-0.105 to 1.050 MPa	-105.0 to 105.0 kPa	-50 to 525 kPa	-0.105 to 2.1 MPa	-0.105 to 5.25 MPa	-0.105 to 10.5 MPa
	Smallest settable increment	1 kPa				10 kPa	
Electrical	Proof pressure	3 MPa	600 kPa	1.5 MPa	5 MPa	12.5 MPa	30 MPa
	Power supply voltage	12 to 24 VDC ±10%, Ripple (p-p) 10% or less					
	Current consumption	35 mA or less					
Protection		Reverse connection protection					
Switch output		NPN or PNP open collector 2 outputs Hysteresis Normal, Reversed Max. load current: 80 mA Max. applied voltage: 30 V Internal voltage drop (Residual voltage): 1.5 V or less (at load current of 80 mA) Delay time: 3.4 ms or less					
Accuracy	Accuracy (Ambient temperature at 25°C)	±1.0% F.S.			±2.5% F.S.		
	Linearity	±0.5% F.S.					
	Repeatability (Ambient temperature at 25°C)	±0.2% F.S.			±0.5% F.S.		
	Temperature characteristics	±2% F.S. (0 to 50°C) ±3% F.S. (-10 to 60°C)	±3% F.S. (0 to 50°C) ±4% F.S. (-10 to 60°C)		±5% F.S. (-10 to 60°C)		
Environment	Enclosure	IP65					
	Withstand voltage	500 VAC for 1 min between terminals and housing					
	Insulation resistance	100 MΩ or more (500 VDC measured via megohmmeter) between terminals and housing					
	Operating temperature range	Operating: -10 to 60°C, Stored: -20 to 70°C (No freezing or condensation)					
Operating humidity range		Operating/Stored: 35 to 85% RH (No condensation)					
Standards		CE/UKCA marking					
Materials of parts in contact with fluid		Piping port: C3604 + Nickel plating, Pressure sensor: Al ₂ O ₃ (Alumina 96%), Sensor seal: FKM + Grease			Piping port: C3604 + Nickel plating, Pressure sensor: Al ₂ O ₃ (Alumina 96%), Sensor seal: FKM		

Piping Specifications

Part no.		PSE570/573/574-01	PSE570/573/574-02	PSE575/576/577-02
Port size	R1/8	R1/4	R1/4	R1/4
	M5 x 0.8	M5 x 0.8	M5 x 0.8	M5 x 0.8
Materials of parts in contact with fluid		Piping port: C3604 + Nickel plating Pressure sensor: Al ₂ O ₃ (Alumina 96%) Sensor seal: FKM + Grease		Piping port: C3604 + Nickel plating Pressure sensor: Al ₂ O ₃ (Alumina 96%) Sensor seal: FKM
Weight	Without lead wire and M12 connector	88 g	95 g	103 g
	With lead wire and M12 connector	175 g	182 g	191 g

Cable Specifications

Part no.		PSE570
Conductor	Nominal cross section	AWG23
	Outside diameter	0.72 mm
Insulator	Material	Cross-linked vinyl chloride
	Outside diameter	1.14 mm
	Color	Brown, Blue, Black, White
Sheath Material		Oil resistant vinyl chloride
Finished O.D.		ø4
Length		3 m

PSE530

PSE540

PSE550

PSE560

PSE570

PSE200A

PSE300A

PSE300AC

Digital Sensor Monitors

PSE570 Series

Internal Circuits and Wiring Examples

PSE57□-□

Voltage output type
1 to 5 V
Output impedance
Approx. 1 kΩ

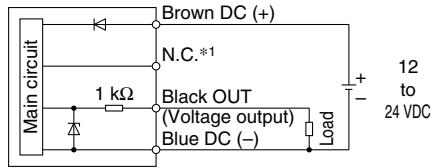

PSE57□-□-28

Current output type
4 to 20 mA
Allowable load impedance
500 Ω or less (at 24 VDC)
100 Ω or less (at 12 VDC)

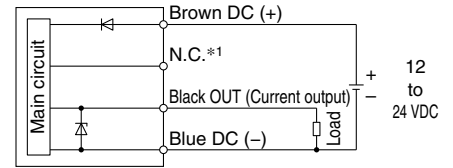

*1 For the analog output type, the unconnected terminals are used in SMC, so please do not connect them.

PSE57□-□-A

NPN open collector (2 outputs)

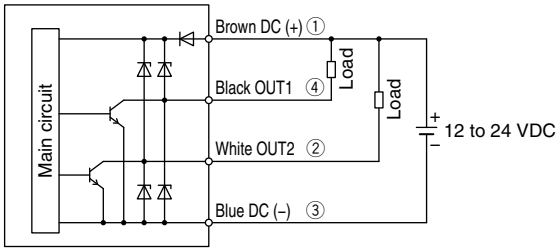

PSE57□-□-B

PNP open collector (2 outputs)

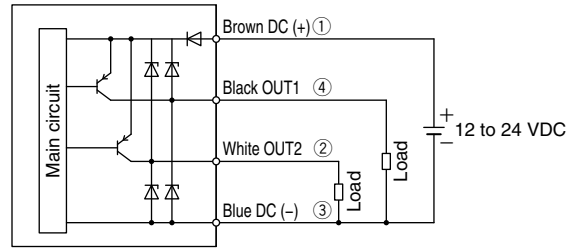

PSE57□-□-L2

When used as a switch output device
Setting of NPN open collector 2 outputs

* The numbers in the circuit diagrams show the connector pin layout.

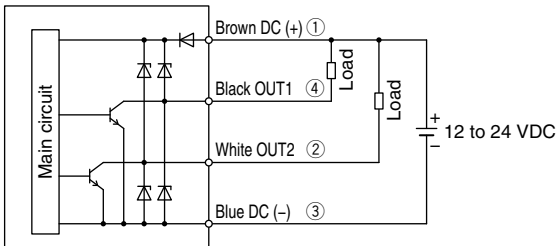

Setting of PNP open collector 2 outputs

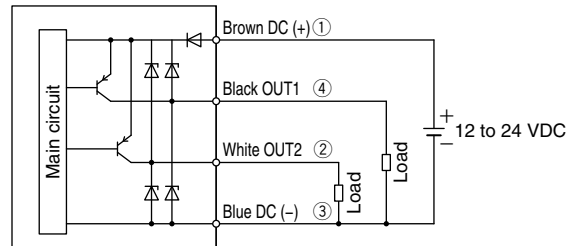

When used as an IO-Link device

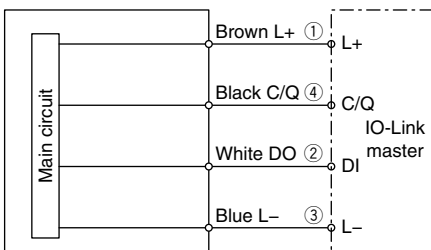

Analog Output

1 to 5 VDC

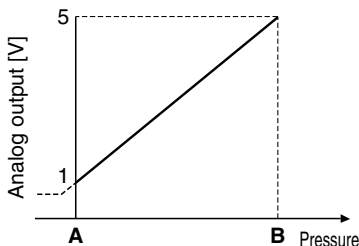

4 to 20 mA DC

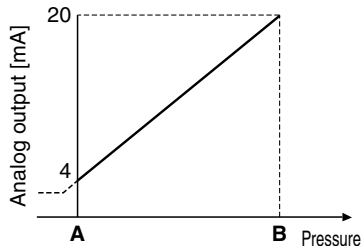

Model	Rated pressure range	A	B
PSE570	0 to 1 MPa	0 MPa	1 MPa
PSE573	-100 to 100 kPa	-100 kPa	100 kPa
PSE574	0 to 500 kPa	0 kPa	500 kPa
PSE575	0 to 2 MPa	0 MPa	2 MPa
PSE576	0 to 5 MPa	0 MPa	5 MPa
PSE577	0 to 10 MPa	0 MPa	10 MPa

IO-Link: Process Data

PSE570-L2 (For positive pressure)

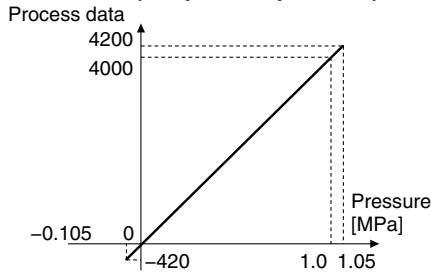

PSE573-L2 (For compound pressure)

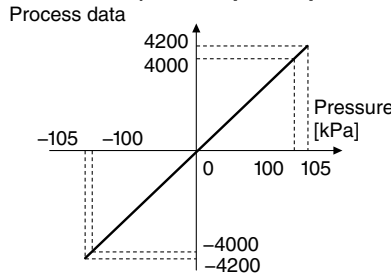

PSE574-L2 (For positive pressure)

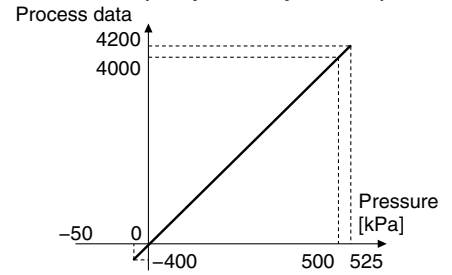

PSE575-L2 (For positive pressure)

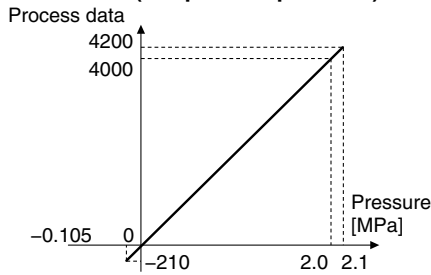

PSE576-L2 (For positive pressure)

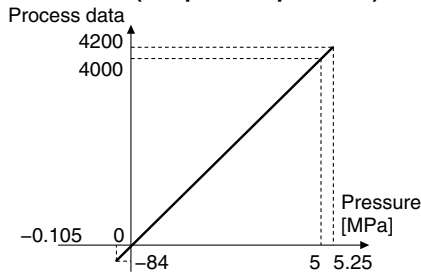

PSE577-L2 (For positive pressure)

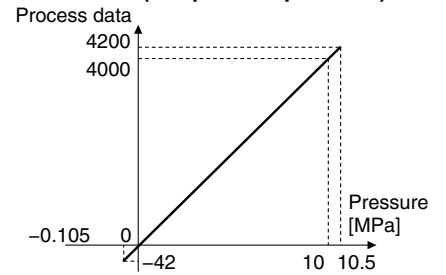

Lead wire and M12 connector (Connector on both sides)

EX9-AC 005 -SSPS (With connector on both sides (Socket/Plug))

● Cable length (L)

005	500 mm
010	1000 mm
020	2000 mm
030	3000 mm
050	5000 mm
100	10000 mm

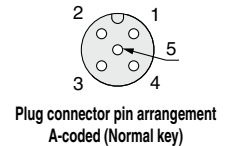
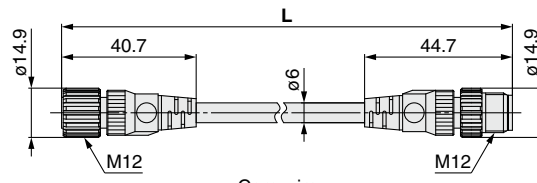
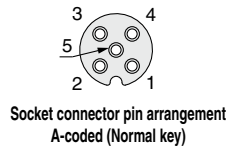

Terminal no.

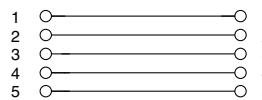

Core wire color

- 1 Brown
- 2 White
- 3 Blue
- 4 Black
- 5 Gray

Connections

Item	Specifications
Cable O.D.	ø6 mm
Conductor nominal cross section	0.3 mm ² /AWG22
Wire O.D. (Including conductor)	1.5 mm
Min. bending radius (Fixed)	40 mm

PSE530

PSE540

PSE550

PSE560

PSE570

Digital Sensor Monitors

PSE200A

PSE300A

PSE300AC

PSE570 Series

Dimensions

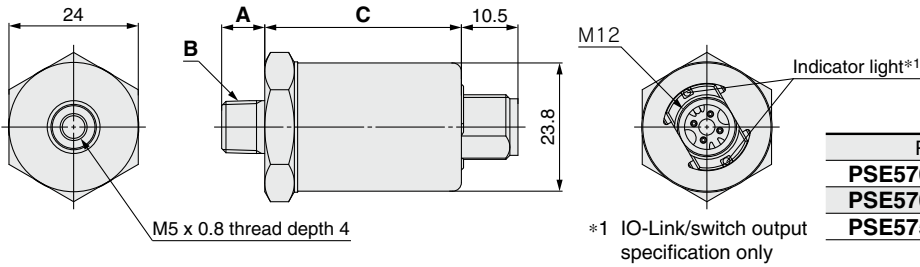

Part no.	A	B	C
PSE570/573/574-01	8	R1/8	36.5
PSE570/573/574-02	12	R1/4	36.5
PSE575/576/577-02	12	R1/4	39.7

Lead wire and M12 connector

ZS-37-A

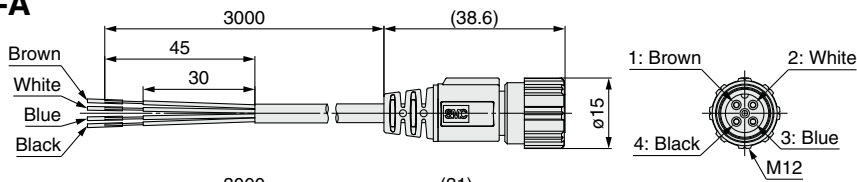

Pin no.	Lead wire color	Description
1	Brown	DC (+)
2	White	N.C.*1/OUT2
3	Blue	DC (-)
4	Black	OUT1

*1 For the analog output type, the unconnected terminals are used in SMC, so please do not connect them.

ZS-37-B

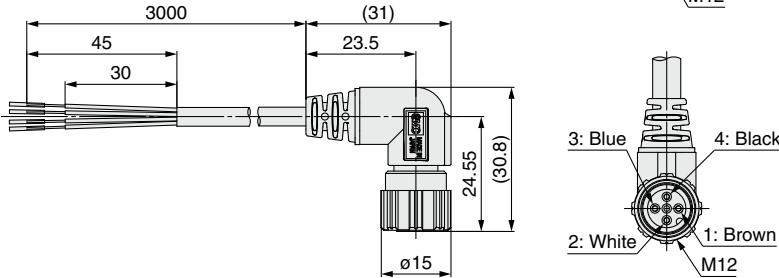

Part no.	Description
ZS-37-A	Straight type 3 m
ZS-37-B	Right angle type 3 m

Adapter with restrictor

ZS-31-X□□□

Material:
Stainless steel 304

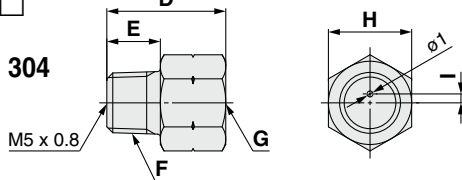

Part no.	D	E	F	G	H	I
ZS-31-X188	20	9	R1/8	Rc1/8	14	1.5
ZS-31-X175	29	13	R1/4	Rc1/4	17	1.6

Orifice

ZS-48-A

Material:
Stainless steel 303

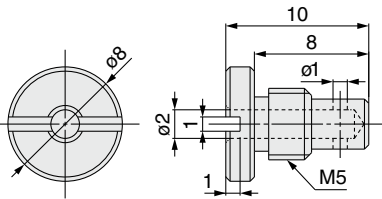

*If it is expected that the pressure, such as water hammer or surge pressure, will fluctuate rapidly, refer to the precautions in the Operation Manual on the SMC website.

3-Screen Display

Multi-channel Digital Sensor Monitor

PSE200A Series



Applicable sensors					Rated pressure range					Set/Display resolution
PSE53□	PSE54□	PSE55□	PSE56□	PSE57□	-100 kPa	0	100 kPa	500 kPa	1 MPa 10 MPa	
PSE531	PSE541	—	PSE561	—	-101 kPa	0				0.1 kPa
PSE533	PSE543	—	PSE563	PSE573	-100 kPa		100 kPa			0.2 kPa
PSE530	PSE540	—	PSE560	PSE570		0		1 MPa		0.001 MPa
—	—	—	—	PSE575		0		2 MPa		0.001 MPa
—	—	—	—	PSE576		0		5 MPa		0.01 MPa
—	—	—	—	PSE577		0		10 MPa		0.01 MPa
PSE532	—	—	—	—		0	100 kPa			0.1 kPa
—	—	—	PSE564	PSE574		0		500 kPa		1 kPa
—	—	PSE550	—	—		0	2 kPa			0.01 kPa

Up to 4 pressure sensors can be connected!

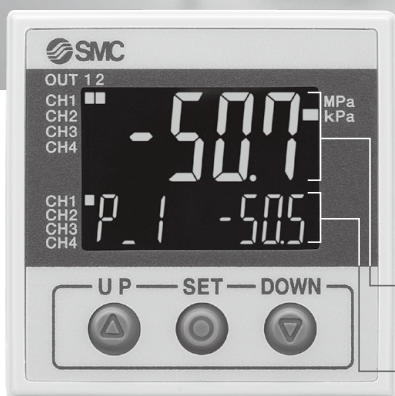
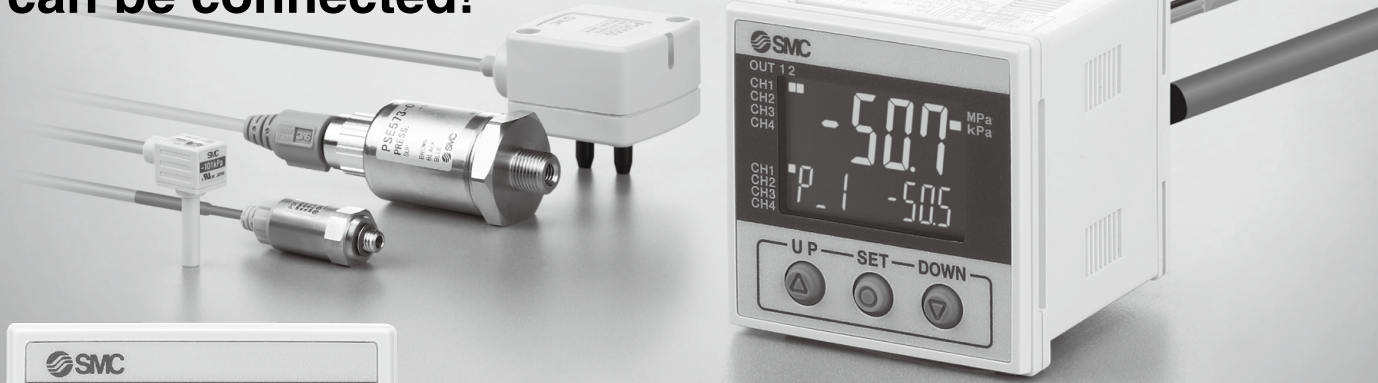

It is possible to change the settings while checking the measured value.

Main screen Measured value (Current pressure value)

Sub screen Left side Right side
Label (Display item), Set value (Threshold value)

Visualization of Settings

Set value (Threshold value)	P.1
Hysteresis value	H.1
Peak value	H.H.
Bottom value	H.Lo
Channel display	CH.1

- Differential Pressure Check Mode [p. 34](#)
- 3 channels are displayed simultaneously. [p. 34](#)

- Input Range Selection [p. 35](#)

IO-Link Compatible

• Hub Function

Convert analog signals to digital signals!

* For details, refer to the "Operation Manual" on the SMC website.



Applicable Pressure Sensor Variations

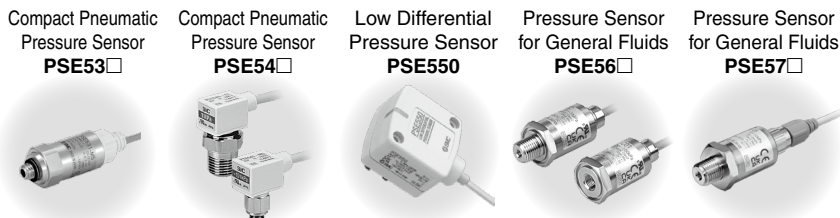

PSE530
PSE540
PSE550
PSE560
PSE570
PSE200A
PSE300A
PSE300AC

Visualization of Settings

Item and set value are displayed together.
Easy to confirm the displayed item

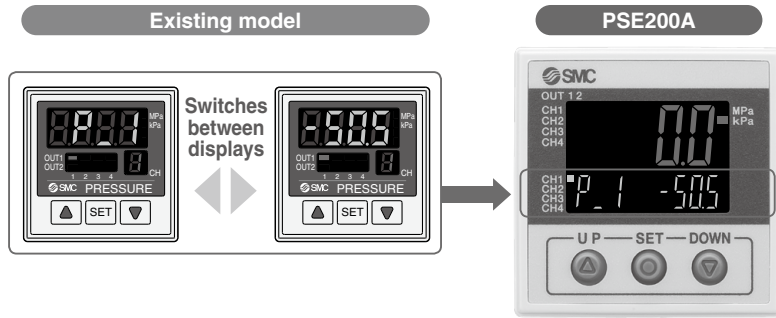

Mode Examples

Mode	Normal output	Set value (Threshold value)	Reversed output	Set value (Threshold value)	Hysteresis	Set hysteresis value		
Hysteresis mode	P.1	-505	n.1	-505	H.1	51		
Window comparator mode	Normal output/ Lo side	Set value (Threshold value)	Normal output/ Hi side	Set value (Threshold value)	Reversed output/ Lo side	Set value (Threshold value)	Reversed output/ Hi side	Set value (Threshold value)
	P.L	-300	P.H	-600	n.L	-300	n.H	-600

Easy Screen Switching

It is possible to change the settings while checking the measured value.

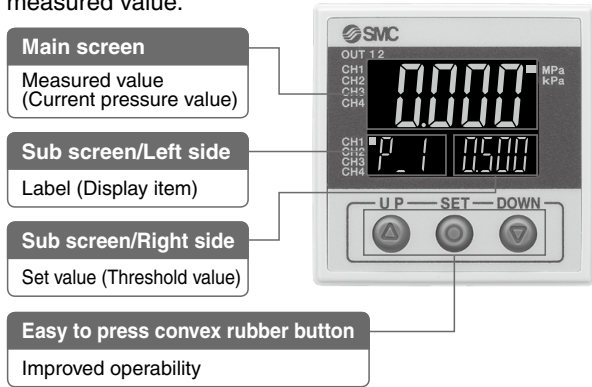

The sub screen can be switched by pressing the down buttons.

Simple 3-Step Setting

After selecting the channel, when the SET button is pressed and the set value (P_1) is displayed, the set value (threshold value) can be set.

When the SET button is pressed and the hysteresis (H_1) is being displayed, the hysteresis value can be set.

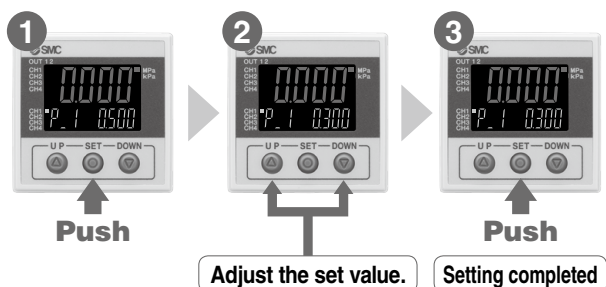

Now with a snap shot function for set value reading

Snap shot function Pressing the **▲** and **▼** buttons simultaneously for a minimum of 1 second will make the set value (threshold value) the same as the current pressure value.

Centralized Control Saves Installation Space.

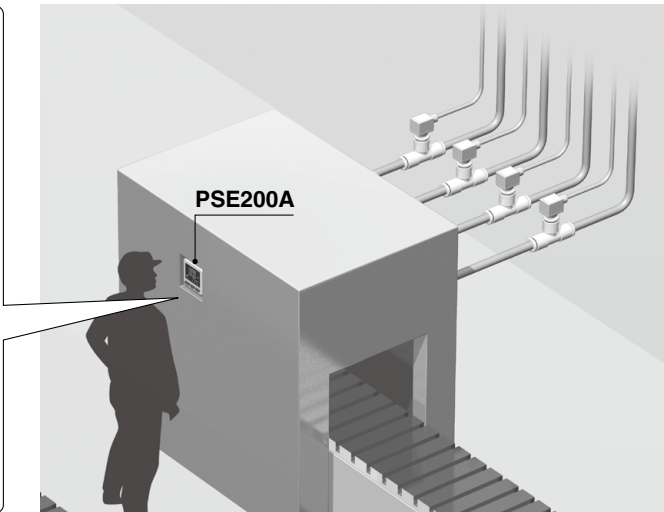
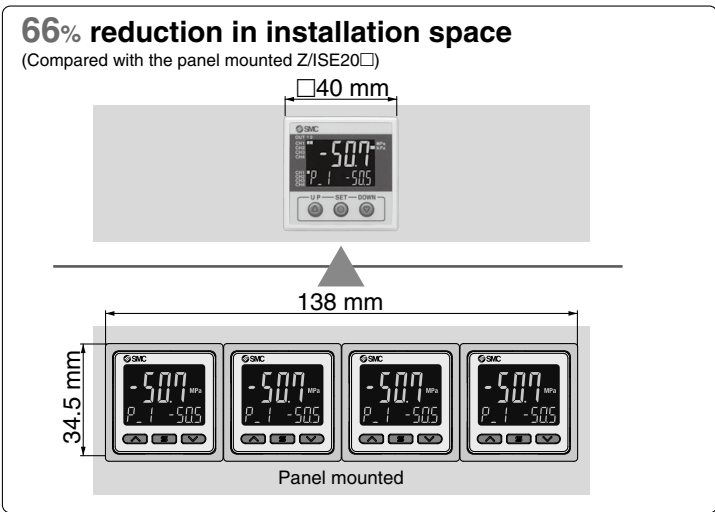

PSE530

PSE540

Differential Pressure Check Mode * For details, refer to the "Operation Manual" on the SMC website.

One monitor displays 2 lines of differential pressure.

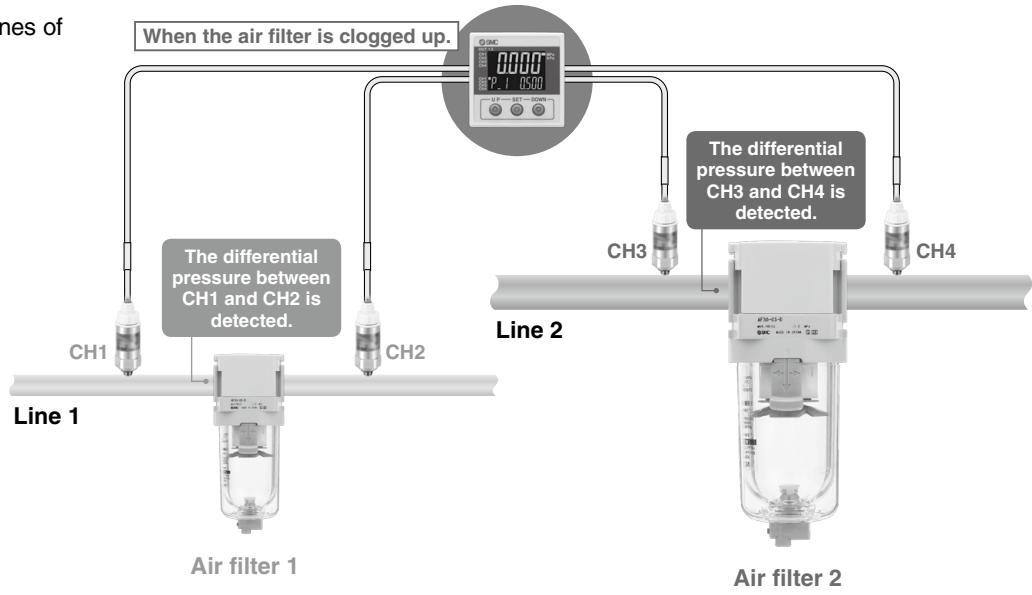

PSE550

PSE560

PSE570

A Single Monitor Various Applications

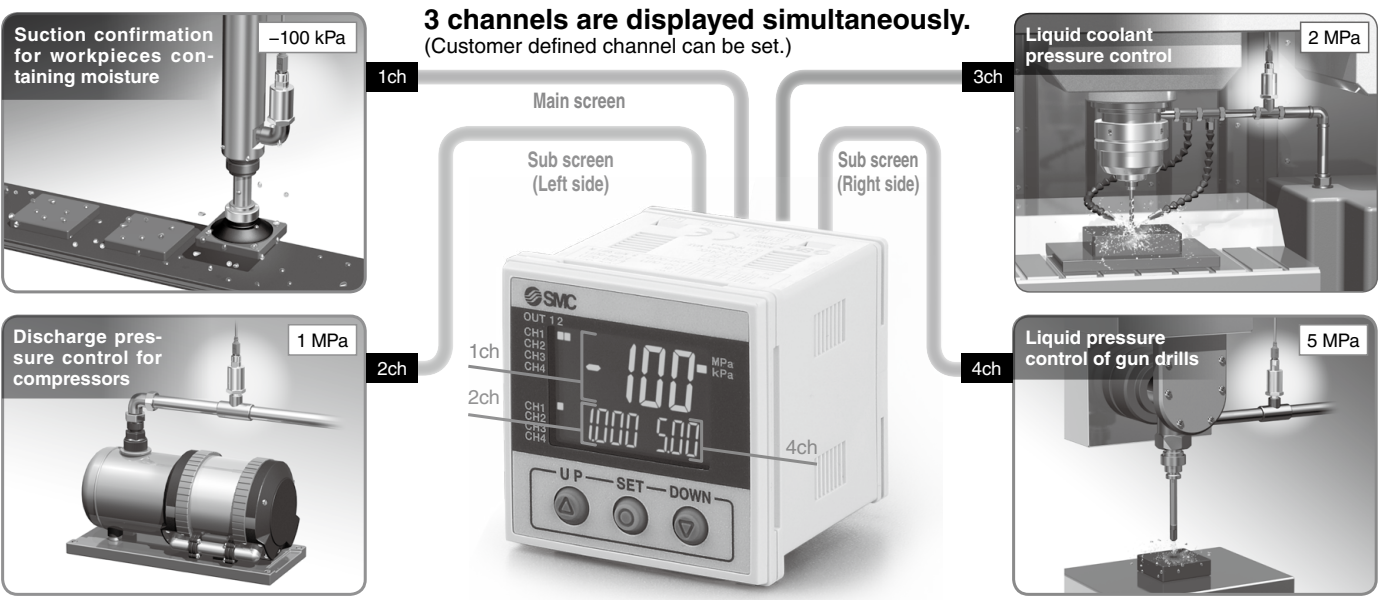

PSE200A

PSE300A

PSE300AC

Digital Sensor Monitors

Input Range Selection (for Pressure/Flow rate)

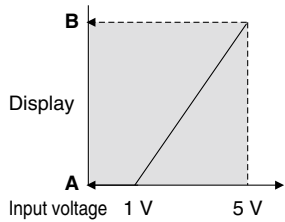

The sensor input range can be set to the required value and displayed. (Voltage input: 1 to 5 V)
Pressure switch/Flow switch can be displayed.

A is displayed for 1 V. B is displayed for 5 V.

The range can be set as required.

Refer to page 38 for the specification of the sensors which can be connected.

For the individual specifications of each connectable sensor, refer to the **Web Catalog**.

For Digital Flow Switch for Water / PF3W511

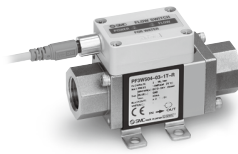

	A	B
PF3W504	0	4
PF3W520	0	16
PF3W540	0	40
PF3W511	0	100

Set A and B to the values shown in the table on the left.

For Flow Sensor / PFMV5



Setting of the display for analog voltage

	A	B
PFMV5 Series	1.00	5.00

Set A and B to the values shown in the table on the left.

Connectors

Connection and removal of wiring is easy.

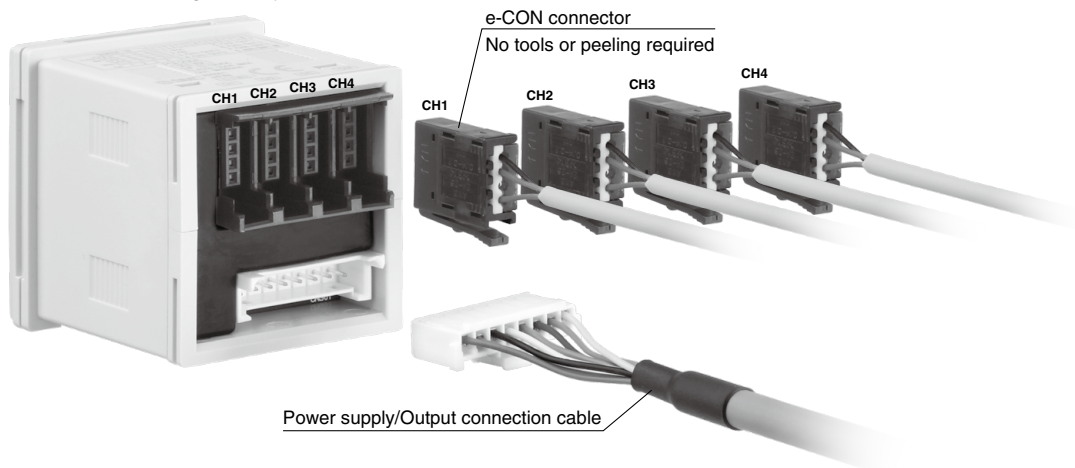

Functions * For details, refer to the "Operation Manual" on the SMC website.

Auto-preset function

This function, when selected in the initial setting, calculates and stores the set value from the measured pressure.

Display value fine adjustment function

Fine adjustment of the indicated value of the pressure sensor can be made within the range of $\pm 5\%$ of the read value.

Peak/Bottom value indication function

This function constantly detects and updates the maximum (minimum) pressure when the power is supplied, and allows to hold the maximum (minimum) pressure value.

Key-lock function

This function prevents operation errors such as accidentally changing setting values.

Zero-clear function

This function clears and resets the zero value on the display of measured pressure.

Error display function

This function displays error location and content when a problem or error has occurred.

Anti-chattering function

This function prevents the detection of such temporary drops in the supply pressure as errors by changing the delay time setting.

Pressure range/Unit selection function

The pressure range and displayed unit can be switched.

Zero-cut setting

When the pressure display value is close to zero, this function forces the display to zero.

Selection of power-saving mode

Power-saving mode can be selected. It shifts to power-saving mode automatically when there is no button operation for 30 seconds.

Setting of security code

Users can select whether a security code must be entered to release the key lock.

Auto-shift function

This function compensates for such supply pressure fluctuations. It measures the pressure at the time of auto-shift signal input and uses it as the reference pressure to correct the set value on the switch.

Differential pressure check mode

Set and display the differential pressure between CH1 - CH2, and CH3 - CH4.

Channel to channel copy function

The set values can be copied to other channel.

Channel select function

Pressure value for the selected channel is displayed.

Channel scan function

Pressure values for each channel are displayed in turn every 2 seconds.

Series Variations

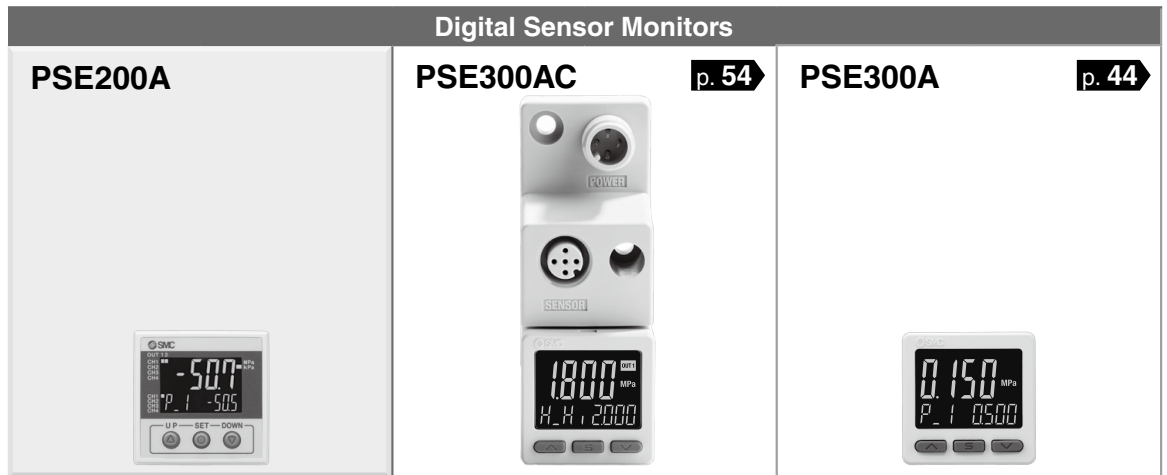

Basic Specifications	Repeatability	$\pm 0.1\%$ (F.S.)	$\pm 0.1\%$ (F.S.)
	Voltage	12 to 24 VDC	12 to 24 VDC
	No. of outputs for switch	5 outputs	2 outputs
	Analog output	—	1 to 5 V 4 to 20 mA
	Operating temperature	0 to 50°C	0 to 50°C

Functions	Number of screens	3	3
	Enclosure	Front face: IP65 Others: IP40	IP65 IP40
	3 Step	Yes	Yes
	Wiring	Connector	Connector

Applicable Pressure Sensors	Compact Pneumatic Pressure Sensor PSE53	Compact Pneumatic Pressure Sensor PSE54	Low Differential Pressure Sensor PSE550	Pressure Sensor for General Fluids PSE56	Pressure Sensor for General Fluids PSE57
	Rated pressure range -101 kPa to 0 -100 kPa to 100 kPa 0 to 100 kPa 0 to 1 MPa	Rated pressure range -101 kPa to 0 -100 kPa to 100 kPa 0 to 1 MPa	Rated pressure range 0 to 2 kPa	Rated pressure range -101 kPa to 0 -100 kPa to 100 kPa 0 to 500 kPa 0 to 1 MPa	Rated pressure range -100 kPa to 100 kPa 0 to 500 kPa 0 to 1 MPa 0 to 2 MPa 0 to 5 MPa 0 to 10 MPa

CONTENTS

How to Order	p. 37	Applicable Pressure Sensors	p. 39
Options/Part Nos.	p. 37	Internal Circuits and Wiring Examples	p. 39
Specifications	p. 38	Dimensions	p. 42

PSE530
PSE540
PSE550
PSE560
PSE570
PSE200A
PSE300A

3-Screen Display Multi-channel Digital Sensor Monitor

PSE200A Series

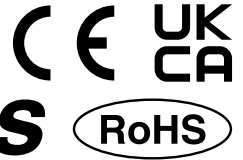

How to Order

PSE20 **0** A - **M** □ □ □

Input/Output specification

0	NPN 5 outputs + Auto-shift input
1	PNP 5 outputs + Auto-shift input
2	IO-Link + NPN 4 outputs or NPN 5 outputs (SIO mode)
3	IO-Link + PNP 4 outputs or PNP 5 outputs (SIO mode)

Unit specification

Nil	With unit selection function*1
M	SI units only*2

- *1 Under the New Measurement Act, switches with the unit selection function are no longer allowed for use in Japan.
- *2 Fixed unit: kPa, MPa, Pa

Option 1

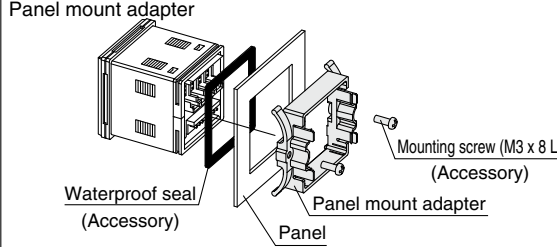
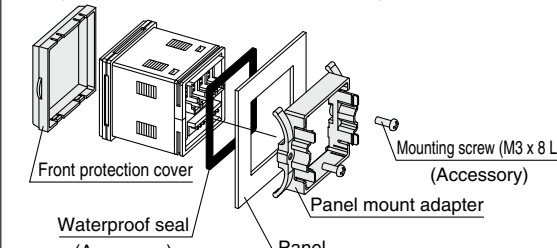
Nil	None
A	Panel mount adapter  Waterproof seal (Accessory) Panel mount adapter Panel Mounting screw (M3 x 8 L) (Accessory)
	Front protection cover + Panel mount adapter  Front protection cover Waterproof seal (Accessory) Panel mount adapter Panel Mounting screw (M3 x 8 L) (Accessory)

* Options are not assembled, but shipped together.

Option 3

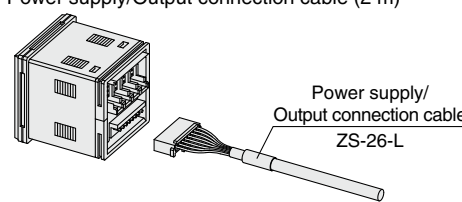
Nil	Power supply/Output connection cable (2 m)  Power supply/Output connection cable ZS-26-L
N	None

* Cable is shipped together, but not connected.

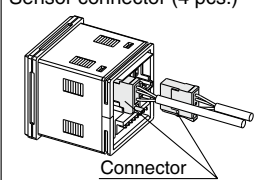

Option 2

Nil	None
4C	Sensor connector (4 pcs.)  Connector

- * Connector is not connected, but shipped together.
- * This connector cannot be used with the PSE570 series.

Options/Part Nos.

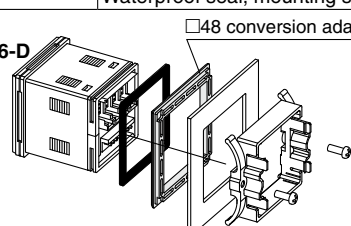
When only optional parts are required, order with the part numbers listed below.

Description	Part no.	Note
Panel mount adapter	ZS-26-B	Waterproof seal, mounting screws M3 x 8 L (2 pcs.) included
Front protection cover + Panel mount adapter	ZS-26-C	Waterproof seal, mounting screws M3 x 8 L (2 pcs.) included
□48 conversion adapter * This adapter is used to mount the PSE200A series on the panel fitting of the PSE100 series.	ZS-26-D	 □48 conversion adapter Order panel mount adapter separately.
Front protection cover	ZS-26-01	
Sensor connector (1 pc. per set)	ZS-28-C ZS-28-CA-4	For the PSE5□□ series (Excludes the PSE570 series) For PSE570 series
Power supply with M12 connector/Output cable (Made to Order) * For use when using an M12 connector for IO-Link communication	ZS-26-LM12	

3-Screen Display Multi-channel Digital Sensor Monitor **PSE200A Series**

For pressure switch precautions and specific product precautions, refer to the "Operation Manual" on the SMC website.

Specifications

Series	PSE200A								
Applicable SMC pressure sensor	PSE550	PSE531 PSE541 PSE561	PSE533 PSE543 PSE563 PSE573	PSE532	PSE564 PSE574	PSE530 PSE540 PSE560 PSE570	PSE575	PSE576	PSE577
Rated pressure range	0 to 2 kPa	0 to -101 kPa	-100 to 100 kPa	0 to 100 kPa	0 to 500 kPa	0 to 1 MPa	0 to 2 MPa	0 to 5 MPa	0 to 10 MPa
Display/Set pressure range	-0.2 to 2.1 kPa	10 to -105 kPa	-105 to 105 kPa	-10 to 105 kPa	-50 to 525 kPa	-0.105 to 1.05 MPa	-0.105 to 2.1 MPa	-0.25 to 5.25 MPa	-0.5 to 10.5 MPa
Display/Smallest settable increment	0.001 kPa	0.1 kPa	0.1 kPa	0.1 kPa	1 kPa	0.001 MPa	0.001 MPa	0.01 MPa	0.01 MPa
Electrical	Power supply voltage	When used as a switch output device 12 to 24 VDC ±10% with 10% ripple (p-p) or less							
	When used as an IO-Link device	18 to 30 VDC, including ripple (p-p) 10%*1							
	Current consumption	55 mA or less							
	Protection	Polarity protection							
	Power supply voltage for sensor ^{#1}	[Power supply voltage] -1.5 V							
	Power supply current for sensor ^{#2}	Max. 50 mA (However, the total current for the 4 inputs is 200 mA maximum or less.)							
Accuracy	Display accuracy	±0.5% F.S. ±1 digit (Ambient temperature of 25 ±3°C)							
	Repeatability	±0.1% F.S. ±1 digit							
	Temperature characteristics	±0.5% F.S. (Reference: 25°C)							
Switch output (SIO mode)	Output type	NPN or PNP open collector output: 5 outputs							
	Output mode	Hysteresis mode, Window comparator mode, Error output, Output OFF							
	Switch operation	Normal output, Reversed output							
	Max. load current	80 mA							
	Max. applied voltage (NPN only)	30 VDC							
	Internal voltage drop (Residual voltage)	1.5 V or less (at load current of 80 mA)							
	Delay time*3	5 ms or less, variable from 0 to 60 s/0.01 s increments							
	Hysteresis	Variable from 0*4							
	Protection	Over current protection							
	Sensor input	Input type	Voltage input: 1 to 5 VDC (Input impedance: 1 MΩ)						
Number of inputs		4 inputs							
Connection method		e-CON							
Protection		Over voltage protection (up to a voltage of 26.4 VDC)							
	Auto-shift input*5	Voltage free input (Reed or Solid state), input for 5 ms or longer, Independently controllable auto-shift function ON/OFF							
Display	Unit*6	MPa, kPa, Pa, kgf/cm ² , bar, mbar, psi, inHg, mmHg, mmH ₂ O (depends on selected range)							
	Display type	LCD							
	Number of screens	3-screen display (Main screen, Sub screen x 2)							
	Display color	Main screen: Red/Green, Sub screen: Orange							
	Number of display digits	Main screen: 4 digits (7 segments), Sub screen (Left): 4 digits (some digits are 11-segments, 7 segments for other), Sub screen (Right): 5 digits (some digits are 11-segments, 7 segments for other)							
	Indicator light	Lights up when switch output is turned ON. OUT1, OUT2: Orange							
	Digital filter*7	Variable from 0 to 30 s/0.01 s increments							
Environment	Enclosure	Front face: IP65 (when panel-mounted), Others: IP40*8							
	Withstand voltage	1000 VAC for 1 min between terminals and housing							
	Insulation resistance	50 MΩ or more (500 VDC measured via megohmmeter) between terminals and housing							
	Operating temperature range	Operating: 0 to 50°C, Stored: -10 to 60°C (No condensation)							
	Operating humidity range	Operating/Stored: 35 to 85% RH (No condensation)							
	Standards	CE/UKCA marking							
Weight	Body	51 g (Excludes power supply and output cable)							
	Power supply/Output cable	60 g							
Communication (IO-Link mode)	e-CON (1 pc.)	2 g							
	IO-Link type	Device							
	IO-Link version	V1.1							
	Communication speed	COM2 (38.4 kbps)							
	Configuration file	IODD file*9							
	Minimum cycle time	4.8 ms							
	Process data length	Input data: 10 bytes, Output data: 0 bytes							
	On request data communication	Yes							
	Data storage function	Yes							
	Event function	Yes							
	Vendor ID	131 (0 x 0083)							

*1 Check the power supply voltage range of the connected sensor.

*2 Over current on DC (+) side and DC (-) side of the sensor input connector results in breakage of the product.

*3 Value without digital filter (at 0 ms)

*4 If the applied pressure fluctuates around the set value, the hysteresis must be set to a value more than the amount of fluctuation, or chattering will occur.

*5 This setting is only possible for the PSE200A/PSE201A.

*6 This setting is only possible for models with the unit selection function. Only MPa, kPa, or Pa is available for models without this function.

*7 The response time indicates when the set value is 90% in relation to the step input.

*8 If □48 conversion adapter is used, it meets IP40.

*9 The configuration file can be downloaded from the SMC website.

*Products with tiny scratches, marks, or display color or brightness variations which do not affect the performance of the product are verified as conforming products.

Cable Specifications

Conductor area		0.15 mm ² (AWG26)
Insulator	O.D.	0.9 mm
Sheath	Finished O.D.	∅4.8

PSE530

PSE540

PSE550

PSE560

PSE570

PSE200A

PSE300A

PSE300AC

Digital Sensor Monitors

PSE200A Series

Applicable Pressure Sensors

Applicable SMC pressure sensor					Rated pressure range							
PSE53□	PSE54□	PSE550	PSE56□	PSE57□	-100 kPa	0	100 kPa	500 kPa	1 MPa	2 MPa	5 MPa	10 MPa
PSE531	PSE541	—	PSE561	—	-101 kPa	0						
PSE533	PSE543	—	PSE563	PSE573	-100 kPa	100 kPa						
PSE532	—	—	—	—	0	100 kPa						
—	—	—	PSE564	PSE574	0	500 kPa						
PSE530	PSE540	—	PSE560	PSE570	0	1 MPa						
—	—	—	—	PSE575	0	2 MPa						
—	—	—	—	PSE576	0	5 MPa						
—	—	—	—	PSE577	0	10 MPa						
—	—	PSE550	—	—	0	12 kPa						

Internal Circuits and Wiring Examples

PSE20□ A - □□□□

• Input/Output specifications

0

• NPN open collector 5 outputs + Auto-shift 1 input

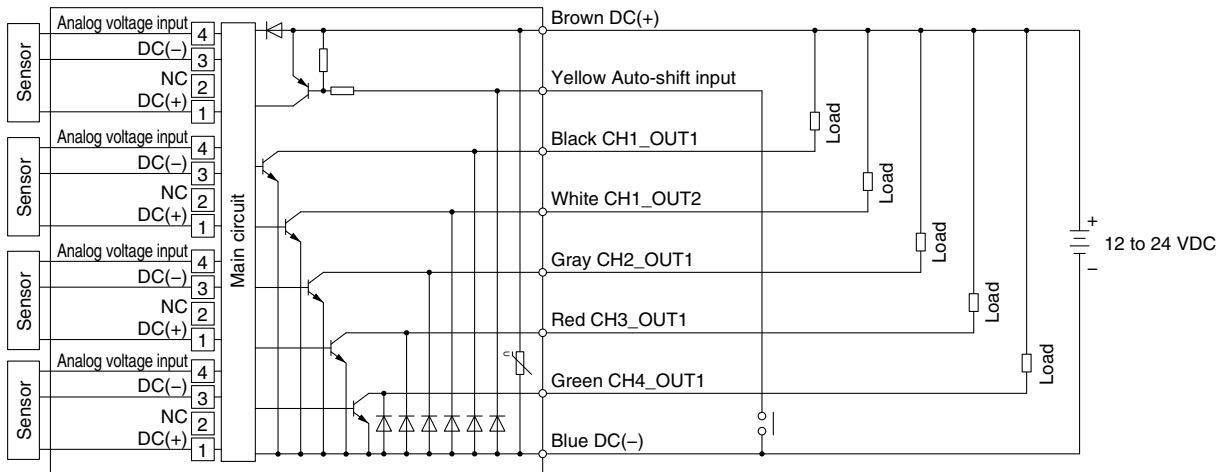

1

• PNP open collector 5 outputs + Auto-shift 1 input

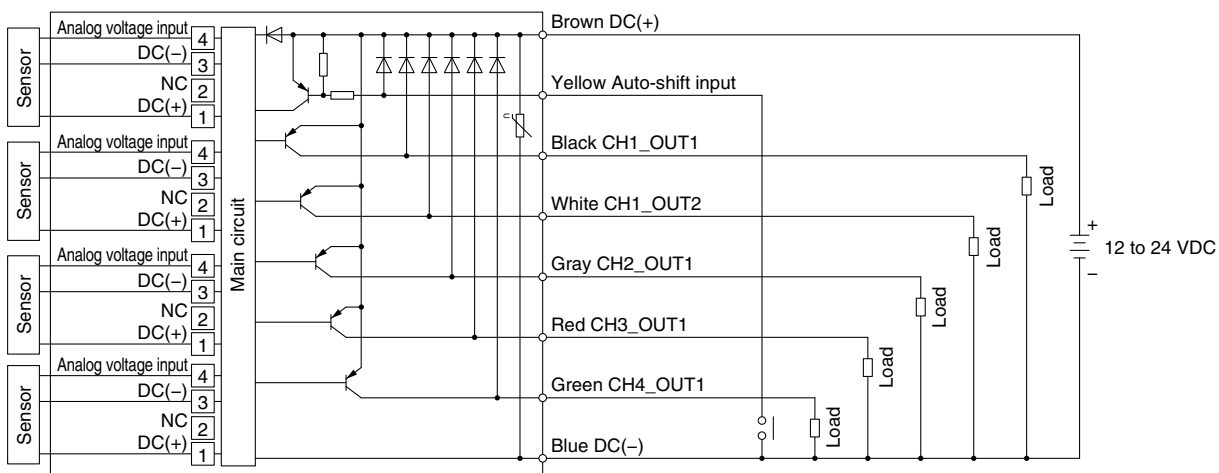

Internal Circuits and Wiring Examples

PSE20 **A** -

• Input/Output specifications

2

· IO-Link/NPN open collector 1 output + NPN open collector 4 outputs

When used as an IO-Link device

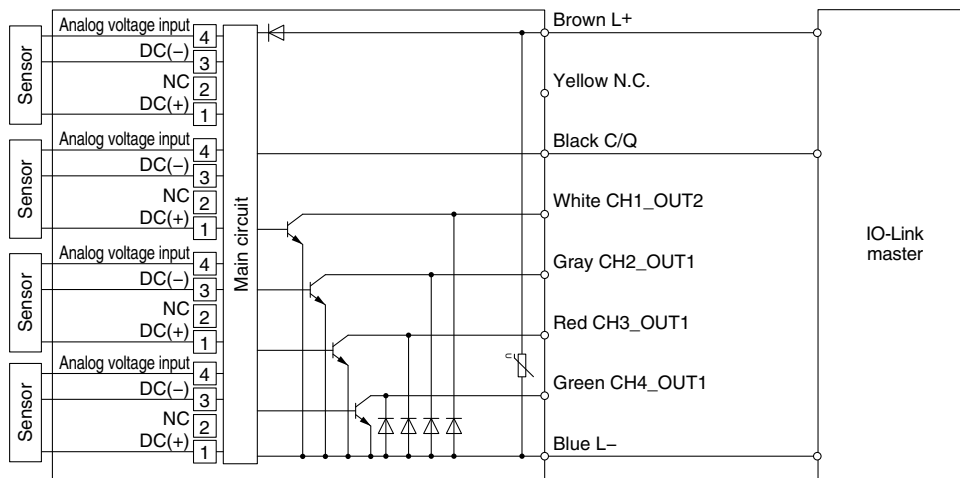

When used as a switch output device

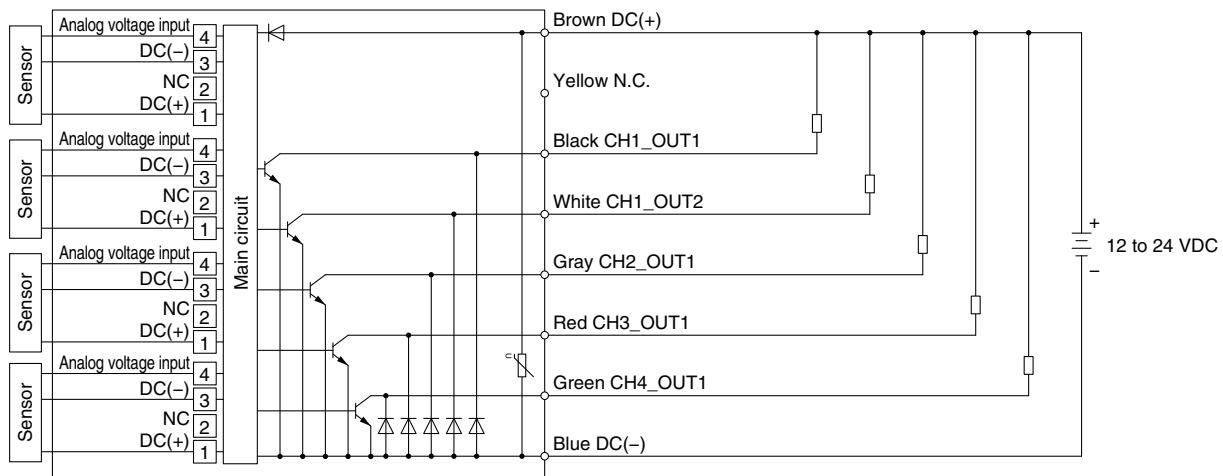

PSE530

PSE540

PSE550

PSE560

PSE570

Digital Sensor Monitors
PSE300AC | **PSE300A** | **PSE200A**

PSE200A Series

Internal Circuits and Wiring Examples

PSE20 A -

• Input/Output specifications

3

· IO-Link/PNP open collector 1 output + PNP open collector 4 outputs

When used as an IO-Link device

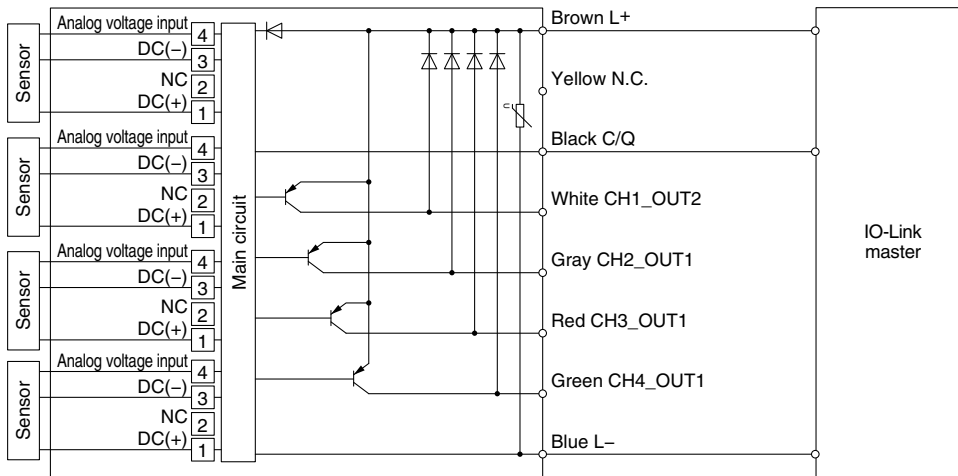

When used as a switch output device

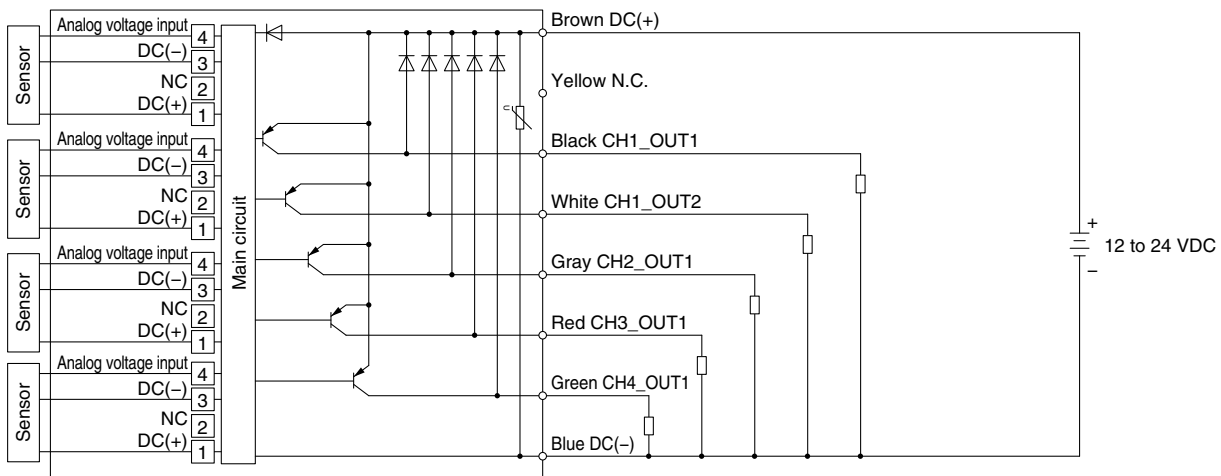

Dimensions

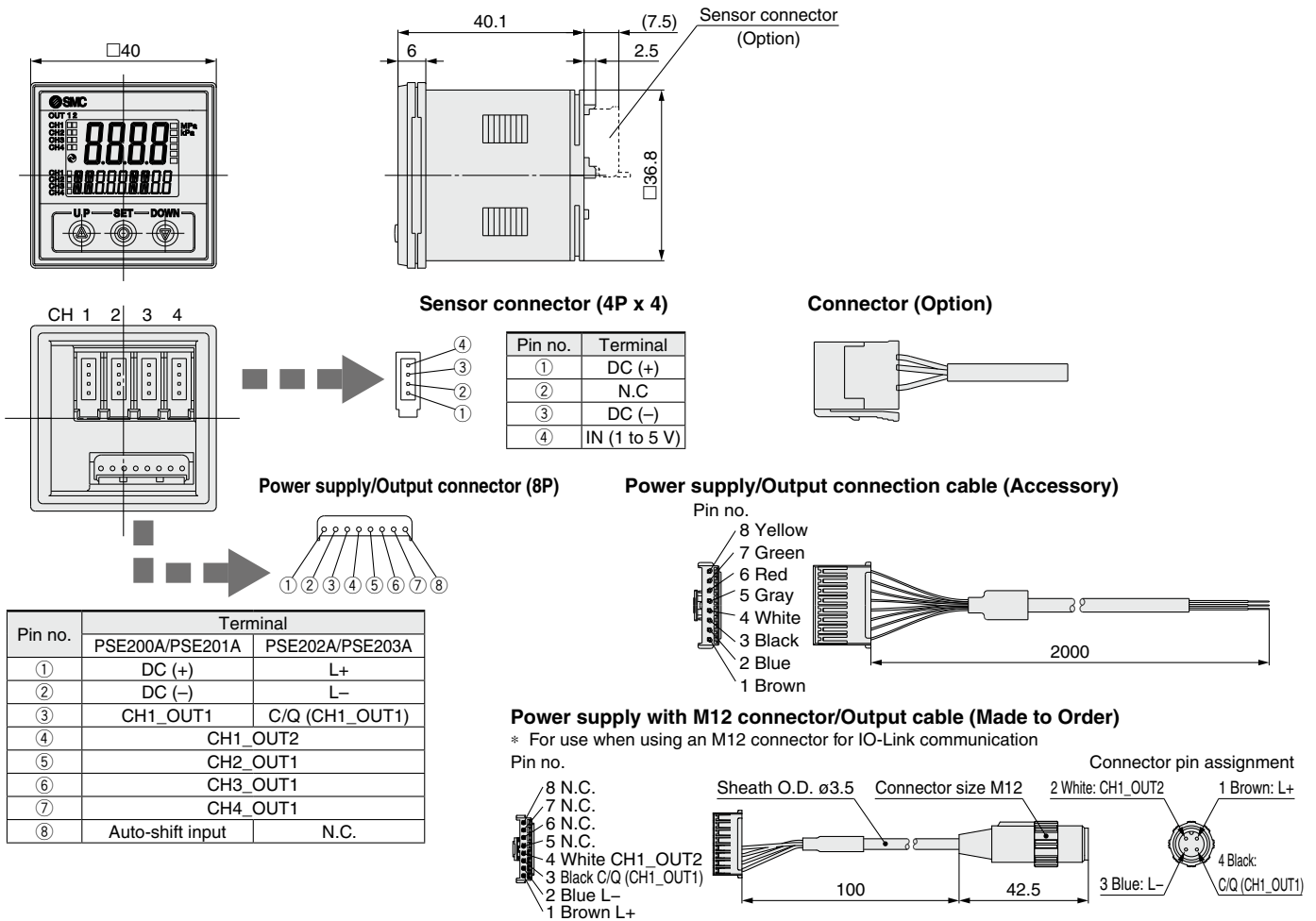

Front protection cover + Panel mount adapter

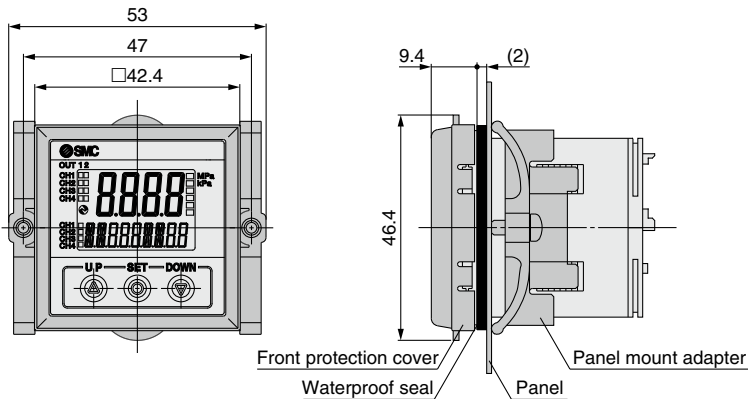

□48 conversion adapter + Panel mount adapter

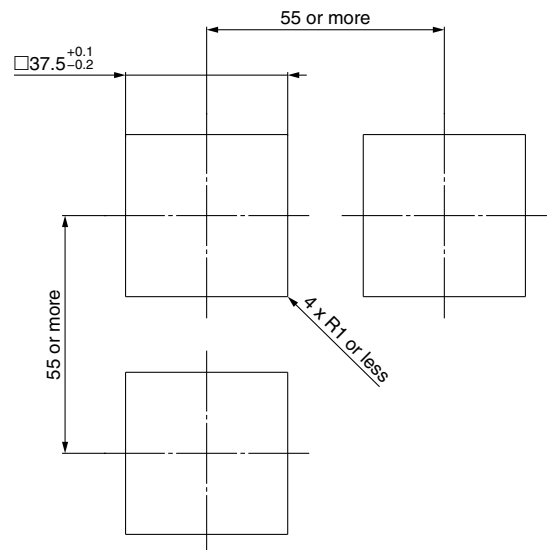
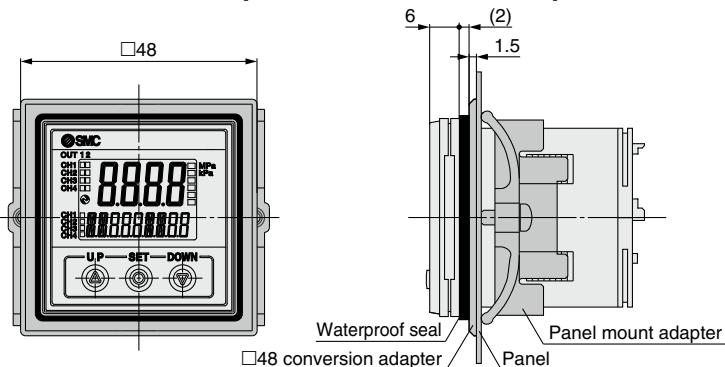

Panel fitting dimensions
Applicable panel thickness:
0.5 to 8 mm

PSE530
PSE540
PSE550
PSE560
PSE570
Digital Sensor Monitors
PSE200A
PSE300A
PSE300AC



3-Screen Display Sensor Monitor

PSE300A Series



Applicable sensors					Rated pressure range					Set/Display resolution
PSE53□	PSE54□	PSE55□	PSE56□	PSE57□	-100 kPa	0	100 kPa	500 kPa	1 MPa 10 MPa	
PSE531	PSE541	—	PSE561	—	-101 kPa	0				0.1 kPa
PSE533	PSE543	—	PSE563	PSE573	-100 kPa		100 kPa			0.2 kPa
PSE530	PSE540	—	PSE560	PSE570		0		1 MPa		0.001 MPa
—	—	—	—	PSE575		0		2 MPa		0.001 MPa
—	—	—	—	PSE576		0		5 MPa		0.01 MPa
—	—	—	—	PSE577		0		10 MPa		0.01 MPa
PSE532	—	—	—	—		0	100 kPa			0.1 kPa
—	—	—	PSE564	PSE574		0		500 kPa		1 kPa
—	—	PSE550	—	—		0	2 kPa			0.01 kPa



Compatible with 5 types of pressure sensor



It is possible to change the settings while checking the measured value.

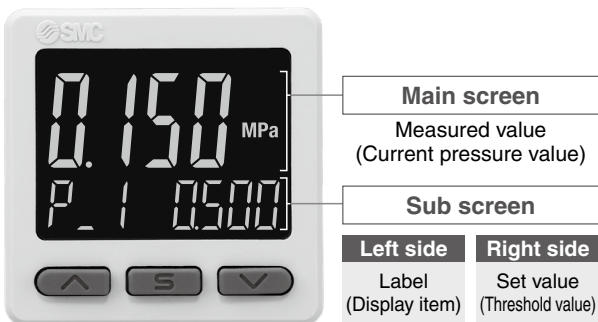

NPN/PNP Switch Function



Input Range Selection (for Pressure/Flow rate)

- Set the displayed value according to the sensor input. (Voltage input: 1 to 5 V/Current input: 4 to 20 mA)
- Value is displayed regardless of the pressure switch or flow switch.

Visualization of Settings

Set value (Threshold value)	P.1	Hysteresis value	H.1
Peak value	H.Hi	Bottom value	H.Lo

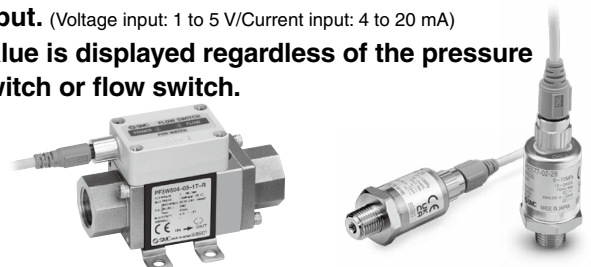

PSE530

PSE540

PSE550

PSE560

PSE570

PSE200A

PSE300A

PSE300AC

Digital Sensor Monitors

Improved Operability

Visualization of Settings

The sub screen (label) shows the item to be set.

Always displayed on one screen

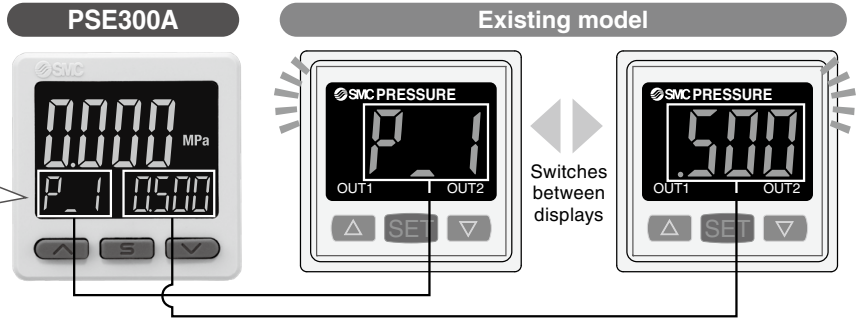

Mode Examples	Hysteresis mode	Normal output	Set value (Threshold value)	Reversed output	Set value (Threshold value)	Hysteresis	Set hysteresis value		
			P_1	0500	n_1	0500	H_1	0050	
Window comparator mode	Window comparator mode	Normal output/Lo side	Set value (Threshold value)	Normal output/Hi side	Set value (Threshold value)	Reversed output/Lo side	Set value (Threshold value)	Reversed output/Hi side	Set value (Threshold value)
			P_L	0300	P_H	0500	n_L	0300	n_H

Simple 3-Step Setting

When the S button is pressed and the set value (P_1) is being displayed, the set value (threshold value) can be set. When the S button is pressed and the hysteresis (H_1) is being displayed, the hysteresis value can be set.



Now with a snap shot function for set value reading

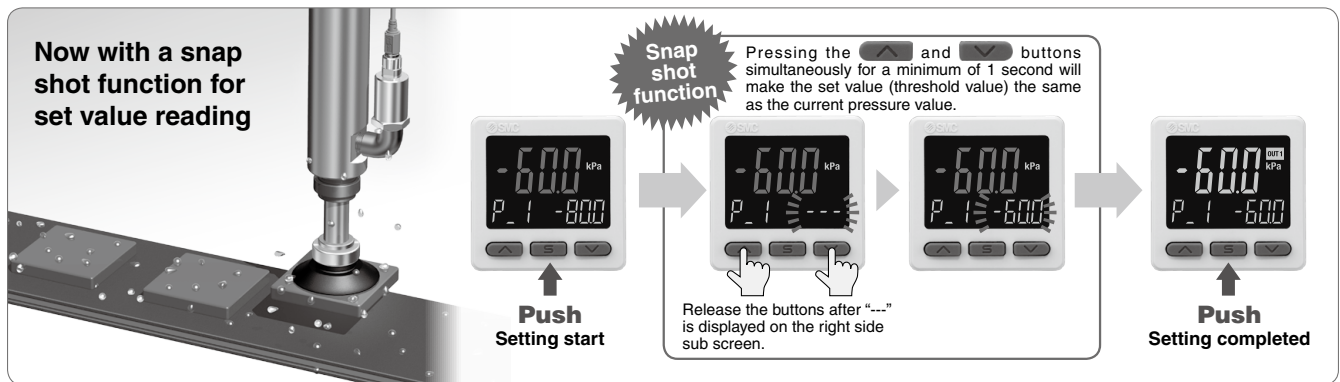

Easy Screen Switching

It is possible to change the settings while checking the measured value.

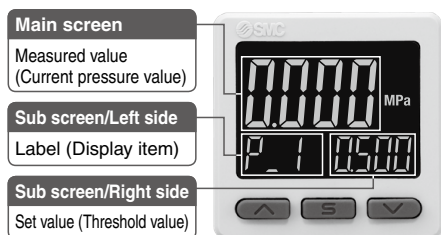

The sub screen can be switched by pressing the up/down buttons.



* One additional arbitrary display mode can be added via the function settings.

Copy Function

The set values of the sensor can be copied.

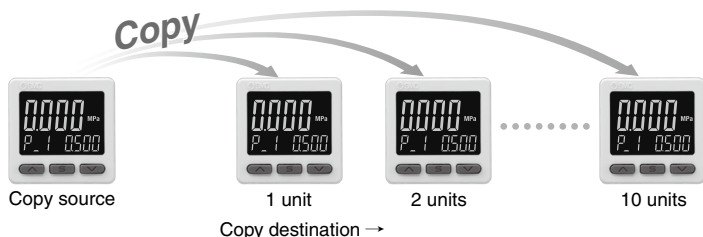

Easy Fitting of Connector

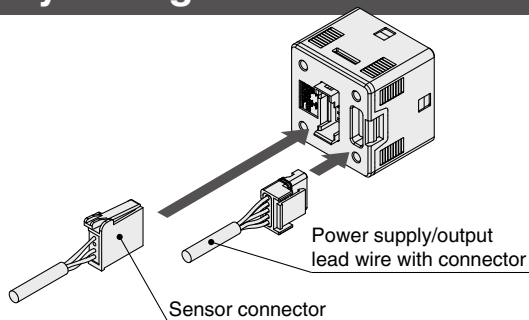

Input Range Selection (for Pressure/Flow rate)

The displayed value to the sensor input can be set as required.

(Voltage input: 1 to 5 V/Current input: 4 to 20 mA)

Pressure switch/Flow switch can be displayed.

A is displayed for 1 V (or 4 mA).
B is displayed for 5 V (or 20 mA).
The range can be set as required.

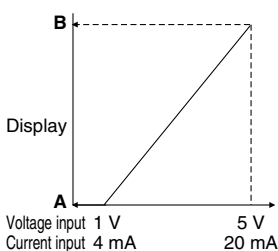

■ For Digital Flow Switch for Water/PF3W511

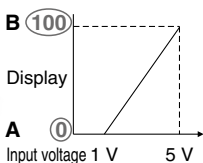

	A	B
PF3W504	0	4
PF3W520	0	16
PF3W540	0	40
PF3W511	0	100

Set A and B to the values shown in the table on the left.

Analog Free Span Function

For the displayed value, the analog span point (5 V, 20 mA) can be changed within the rated pressure range of 10 to 105%*1.

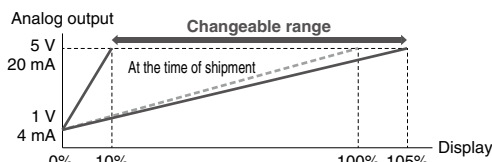

*1 Up to the upper limit of the display/set pressure range.

[Application example]

To output 5 V from the pressure controller at 0.75 MPa, using a sensor that outputs 1 to 5 V at 0 to 1 MPa.

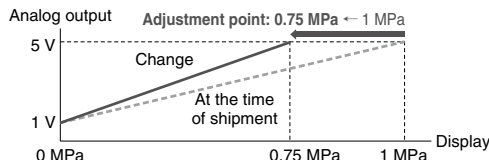



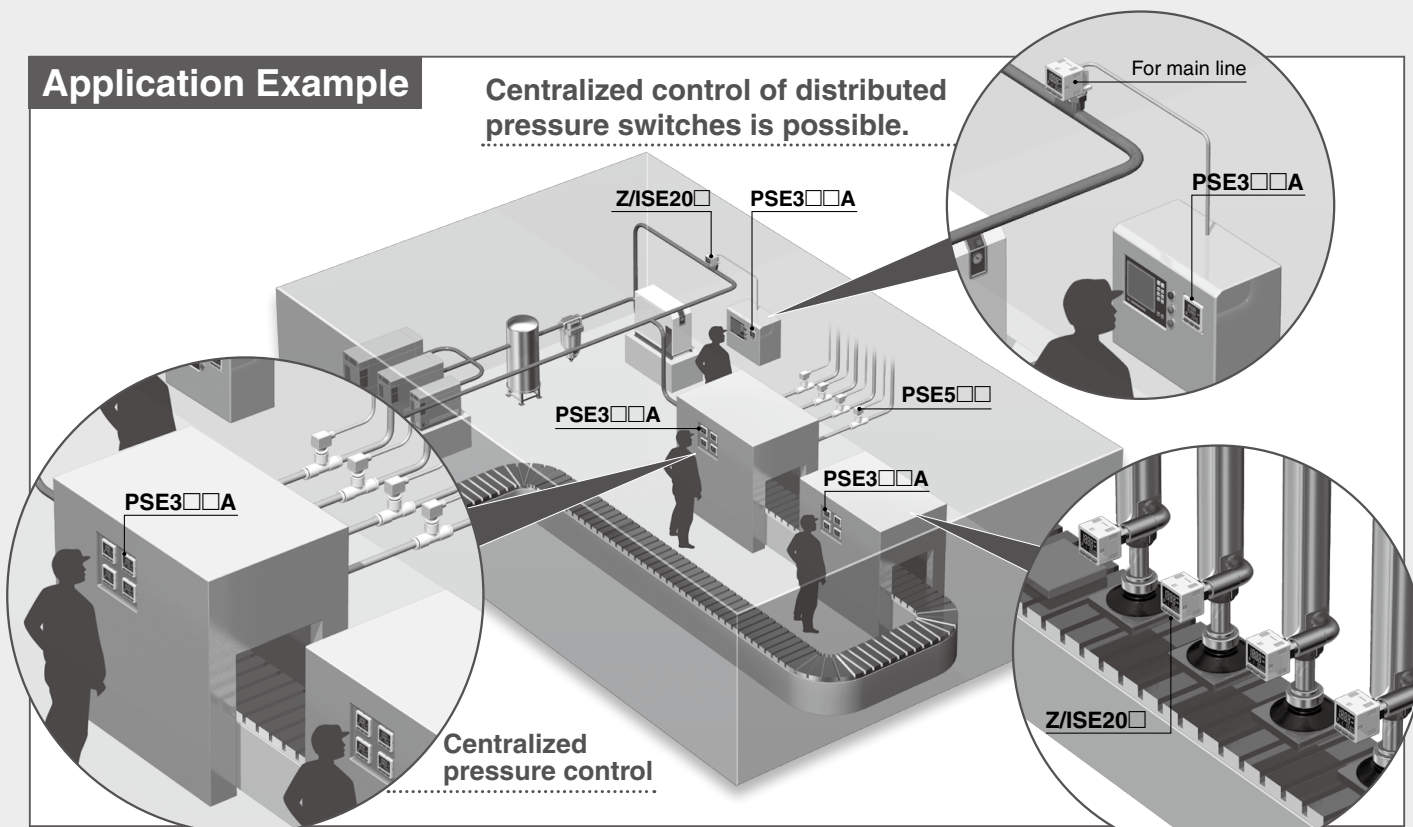

Application Example

Centralized control of distributed pressure switches is possible.



PSE530
PSE540
PSE550
PSE560
PSE570
PSE200A
PSE300A
PSE300AC

Series Variations

		Digital Sensor Monitors				
		PSE300A	PSE200A p. 32	PSE300AC p. 54		
						
Basic Specifications	Repeatability	±0.1% (F.S.)		±0.1% (F.S.)		
	Voltage	12 to 24 VDC		12 to 24 VDC		
	No. of outputs for switch	2 outputs	5 outputs	2 outputs		
	Analog output	1 to 5 V 4 to 20 mA	—			
	Operating temperature	0 to 50°C		0 to 50°C		
Functions	Number of screens	3	3			
	Enclosure	IP40	Front face: IP65 Others: IP40	IP65		
	3-step setting	Yes	Yes			
	Wiring	Connector	Connector			
Applicable Pressure Sensors	Compact Pneumatic Pressure Sensor PSE53 □		Compact Pneumatic Pressure Sensor PSE54 □	Low Differential Pressure Sensor PSE550	Pressure Sensor for General Fluids PSE56 □	Pressure Sensor for General Fluids PSE57 □
	Rated pressure range	-101 kPa to 0 -100 kPa to 100 kPa 0 to 100 kPa 0 to 1 MPa	-101 kPa to 0 -100 kPa to 100 kPa 0 to 1 MPa	0 to 2 kPa	-101 kPa to 0 -100 kPa to 100 kPa 0 to 500 kPa 0 to 1 MPa	-100 kPa to 100 kPa 0 to 500 kPa 0 to 1 MPa 0 to 2 MPa 0 to 5 MPa 0 to 10 MPa

CONTENTS

How to Order	p. 48	Internal Circuits and Wiring Examples	p. 50
Options/Part Nos.	p. 48	Dimensions	p. 51
Specifications	p. 49		

3-Screen Display Sensor Monitor

PSE300A Series



How to Order

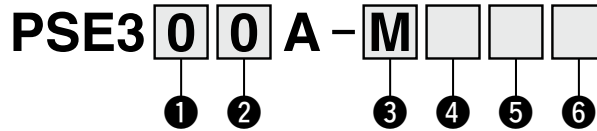

1 Input specification

Symbol	Description
0	Voltage input
1	Current input

2 Output specification

Symbol	Description	Factory default settings
0	NPN/PNP open collector 2 outputs switching type + Analog voltage/Auto-shift/Copy function switching type	NPN open collector 2 outputs + Analog voltage* ¹
3	NPN/PNP open collector 2 outputs switching type + Analog voltage/Auto-shift/Copy function switching type	PNP open collector 2 outputs + Analog voltage* ¹
1	NPN/PNP open collector 2 outputs switching type + Analog current/Auto-shift/Copy function switching type	NPN open collector 2 outputs + Analog current* ²
4	NPN/PNP open collector 2 outputs switching type + Analog current/Auto-shift/Copy function switching type	PNP open collector 2 outputs + Analog current* ²
6	NPN/PNP open collector 2 outputs switching type + Copy function	NPN open collector 2 outputs + Copy function

*1, 2 Although the default output specifications differ, the output specifications are the same.

3 Unit specification

Symbol	Description
Nil	With unit selection function* ¹
M	SI units only* ²

*1 Under the New Measurement Act, switches with the unit selection function are no longer allowed for use in Japan.

*2 Fixed unit: MPa, kPa, Pa

4 Option 1

Symbol	Description
Nil	Without lead wire
L	Lead wire with connector (2 m lead wire)

ZS-46-5L

6 Option 3

Symbol	Description
Nil	None
C	Sensor connector

ZS-28-C

* This connector cannot be used with the PSE570 series.

Options/Part Nos.

When only optional parts are required, order with the part numbers listed below.

Description	Part no.	Note
Bracket	ZS-46-A1	—
Panel mount adapter	ZS-46-B	—
Panel mount adapter + Front protection cover	ZS-46-D	—
Lead wire with connector	ZS-46-5L	5-core, 2 m
Front protection cover	ZS-27-01	—
Sensor connector (1 pc. per set)	ZS-28-C	For the PSE5□□ series (Excludes the PSE570 series)
	ZS-28-CA-4	For the PSE570 series

5 Option 2

Symbol	Description
Nil	None
A	Bracket
B	Panel mount adapter
D	Panel mount adapter + Front protection cover

ZS-46-A1

ZS-46-B

ZS-46-D

PSE530

PSE540

PSE550

PSE560

PSE570

PSE200A

PSE300A

PSE300AC

Digital Sensor Monitors

PSE300A Series

For pressure switch precautions and specific product precautions, refer to the "Operation Manual" on the SMC website.

Specifications

Series		PSE300A								
Applicable SMC pressure sensor		PSE550	PSE531 PSE541 PSE561	PSE533 PSE543 PSE563 PSE573	PSE532	PSE564 PSE574	PSE530 PSE540 PSE560 PSE570	PSE575	PSE576	PSE577
Rated pressure range		0 to 2 kPa	0 to -101 kPa	-100 to 100 kPa	0 to 100 kPa	0 to 500 kPa	0 to 1 MPa	0 to 2 MPa	0 to 5 MPa	0 to 10 MPa
Display/Set pressure range		-0.2 to 2.1 kPa	10 to -105 kPa	-105 to 105 kPa	-10 to 105 kPa	-50 to 525 kPa	-0.105 to 1.05 MPa	-0.105 to 2.1 MPa	-0.25 to 5.25 MPa	-0.50 to 10.5 MPa
Display/Smallest settable increment		0.001 kPa	0.1 kPa	0.1 kPa	0.1 kPa	1 kPa	0.001 MPa	0.001 MPa	0.01 MPa	0.01 MPa
Electrical	Power supply voltage	12 to 24 VDC $\pm 10\%$, Ripple (p-p) 10% or less								
	Current consumption	35 mA or less								
	Protection	Polarity protection								
Accuracy	Display accuracy	$\pm 0.5\%$ F.S. ± 1 digit (Ambient temperature of 25°C)								
	Repeatability	$\pm 0.1\%$ F.S. ± 1 digit								
	Analog output accuracy (To display value)	$\pm 0.5\%$ F.S.								
	Analog output linearity	$\pm 0.2\%$ F.S.								
Temperature characteristics		$\pm 0.5\%$ F.S. (Reference: 25°C)								
Switch output	Output type	Select from NPN or PNP open collector 2 outputs.								
	Output mode	Select from Hysteresis, Window comparator, Error output, or Switch output OFF modes.								
	Switch operation	Select from Normal or Reversed output.								
	Max. load current	80 mA								
	Max. applied voltage (NPN only)	30 VDC								
	Internal voltage drop (Residual voltage)	NPN: 1 V or less (at load current of 80 mA) PNP: 1.5 V or less (at load current of 80 mA)								
	Delay time*1	1.5 ms or less (with anti-chattering function: 20, 100, 500, 1000, 2000, 5000 ms)								
	Hysteresis	Hysteresis mode Window comparator mode	Variable from 0*2							
Protection		Over current protection								
Analog output	Voltage output	Output type*3		Voltage output: 1 to 5 V Extension analog output range: 0.6 to 1 V						
		Output impedance		Approx. 1 k Ω						
	Current output	Output type*3		Current output: 4 to 20 mA Extension analog output range: 2.4 to 4 mA						
		Load impedance		Maximum load impedance at power supply voltage of 12 V: 300 Ω at power supply voltage of 24 V: 600 Ω Minimum load impedance: 50 Ω						
Analog response time		50 ms or less								
Auto-shift input	Input type	Non-voltage input: 0.4 V or less								
	Input mode	Select from Auto-shift or Auto-shift zero.								
	Input time	5 ms or more								
Sensor input	Input type	PSE30□A: Voltage input 1 to 5 VDC (Input impedance: 1 M Ω) PSE31□A: Current input 4 to 20 mA DC (Input impedance: 51 Ω)								
	Number of inputs	1 input								
	Connection method	Connector (e-CON)								
	Protection	Over voltage protection (up to a voltage of 26.4 V)								
Display	Unit*4	MPa, kPa, Pa, kg/cm ² , bar, mbar, psi, inHg, mmHg, mmH ₂ O								
	Display type	LCD								
	Number of screens	3-screen display (Main screen, Sub screen x 2)								
	Display color	1) Main screen: Red/Green 2) Sub screen: Orange								
	Number of display digits	1) Main screen: 4 digits (7 segments) 2) Sub screen: 4 digits (Upper 1 digit 11 segments, 7 segments for other)								
	Indicator light	Lights up when switch output is turned ON. OUT1, OUT2: Orange								
Digital filter*5,*6		0, 10, 50, 100, 500, 1000, 5000 ms								
Environment	Enclosure	IP40								
	Withstand voltage	1000 VAC for 1 min between terminals and housing								
	Insulation resistance	50 M Ω or more (500 VDC measured via megohmmeter) between terminals and housing								
	Operating temperature range	Operating: 0 to 50°C, Stored: -10 to 60°C (No freezing or condensation)								
	Operating humidity range	Operating/Stored: 35 to 85% RH (No condensation)								
Standards		UL/CSA (E216656), CE/UKCA marking								
Weight	Body	25 g (Excludes power supply and output lead wires)								
	Lead wire with connector	+39 g								

*1 Value without digital filter (at 0 ms)

*2 If the sensor input fluctuates around the set value, the hysteresis must be set to a value more than the amount of fluctuation, or chattering will occur.

*3 If the connected sensor does not have an extended analog output range, there is no extended analog output range available for this product.

*4 This setting is only possible for models with the unit selection function. Only MPa, kPa, or Pa is available for models without this function (set by pressure range).

*5 The response time indicates when the set value is 90% in relation to the step input.

*6 Display, switch output and analog response time are affected.

* Products with tiny scratches, marks, or display color or brightness variations which do not affect the performance of the product are verified as conforming products.

Internal Circuits and Wiring Examples

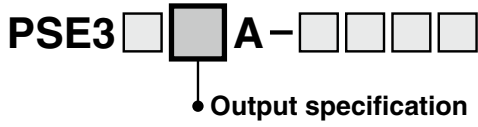

Output specification	Settable circuit	Factory default settings
0	①, ②, ③, ④, ⑤, ⑥	③
1	①, ②, ③, ④, ⑤, ⑥	③
3	①, ②, ③, ④, ⑤, ⑥	④
4	①, ②, ③, ④, ⑤, ⑥	④
6	①, ②	①

① NPN (2 outputs) + Copy function setting

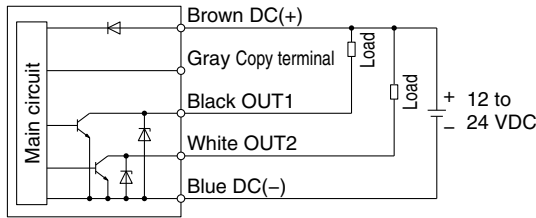

② PNP (2 outputs) + Copy function setting

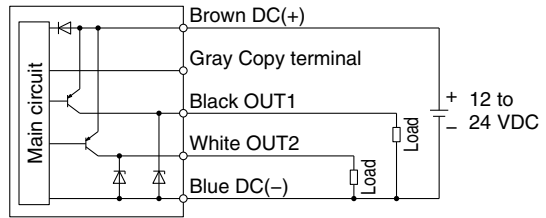

③ NPN (2 outputs) + Analog voltage output setting
NPN (2 outputs) + Analog current output setting

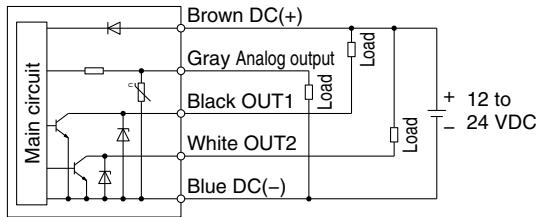

④ PNP (2 outputs) + Analog voltage output setting
PNP (2 outputs) + Analog current output setting

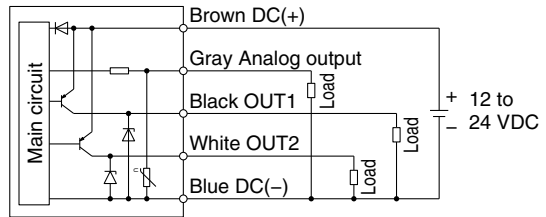

⑤ NPN (2 outputs) + Auto-shift setting

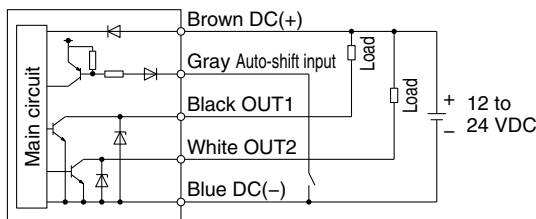

⑥ PNP (2 outputs) + Auto-shift setting

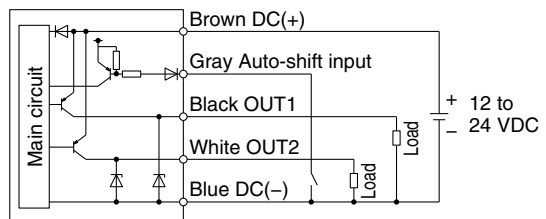

Sensor connector connection

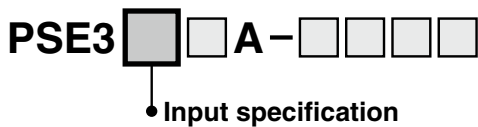

Pin no.	Terminal		
	PSE30 A (Voltage input)	PSE31 A (Current input)	
		Pressure sensor 2-wire type	Pressure sensor 3-wire type
1	DC (+)(Brown)	DC (-)(Brown)	DC (+)(Brown)
2	N.C.	N.C.	N.C.
3	DC (-)(Blue)	N.C.	DC (-)(Blue)
4	IN (1 to 5 V)(Black)	IN (4 to 20 mA)(Blue)	IN (4 to 20 mA)(Black)

* The colors in () indicate the wire color of the PSE5 series.

PSE530

PSE540

PSE550

PSE560

PSE570

PSE200A

PSE300A

PSE300AC

Digital Sensor Monitors

PSE300A Series

Dimensions

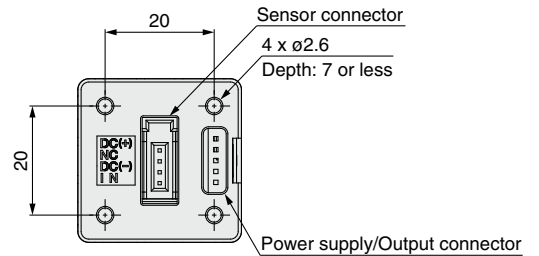
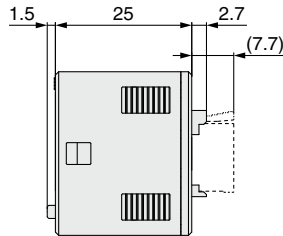
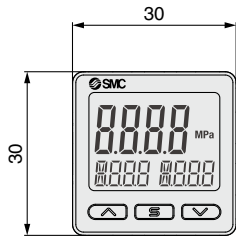
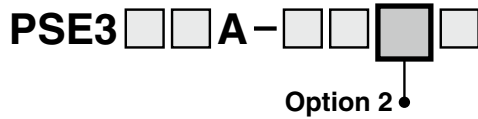

A

Bracket
(Part no.: ZS-46-A1)

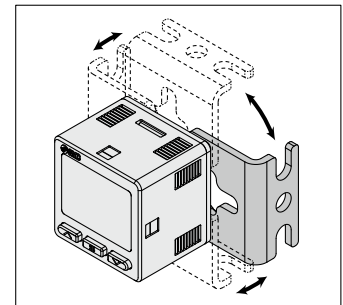
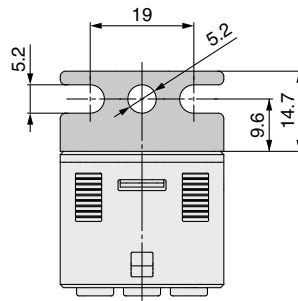
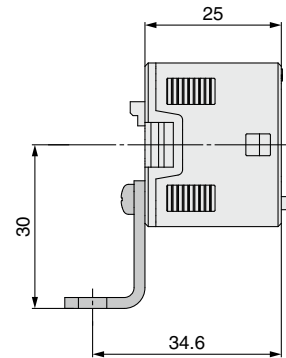
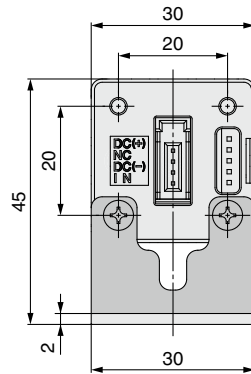

* The bracket configuration allows for mounting in four orientations.

B

Panel mount adapter
(Part no.: ZS-46-B)

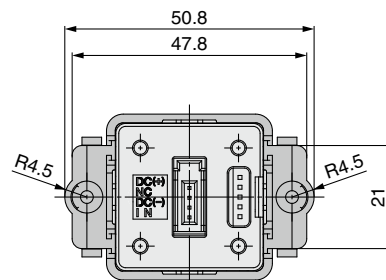
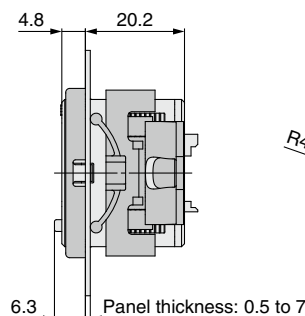
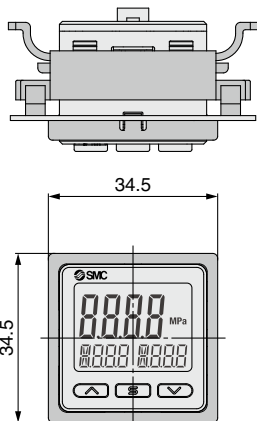

Dimensions

D

Panel mount adapter + Front protection cover
(Part no.: ZS-46-D)

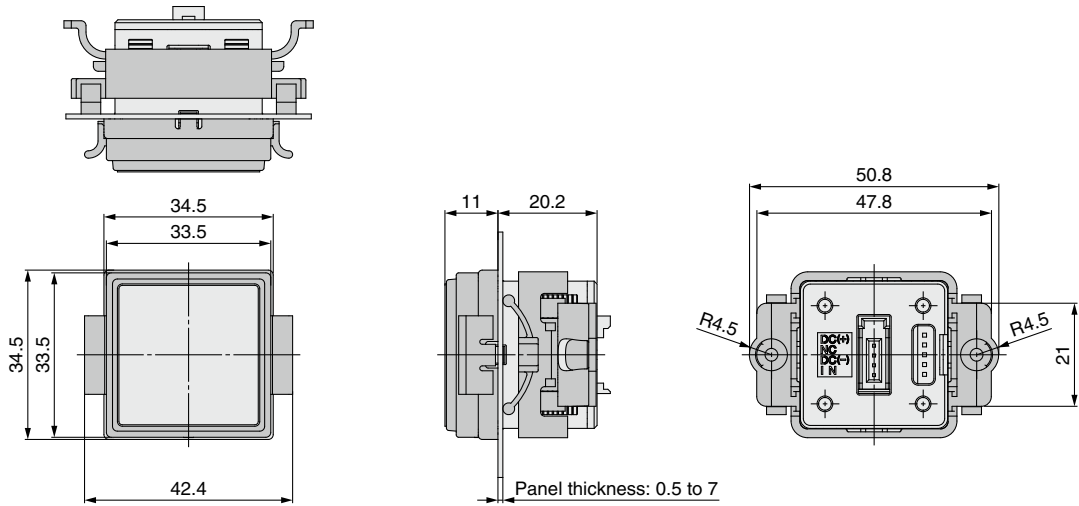

Lead wire with connector
(Part no.: ZS-46-5L)

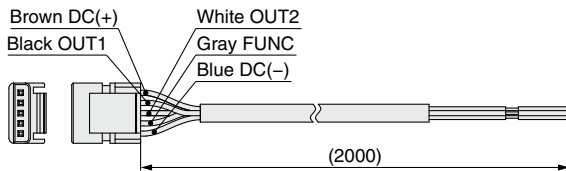

Cable Specifications

Conductor area		0.15 mm ² (AWG26)
Insulator	O.D.	1.0 mm
	Color	Brown, Blue, Black, White, Gray (5-core)
Sheath	Finished O.D.	ø3.5

PSE530

PSE540

PSE550

PSE560

PSE570

Digital Sensor Monitors

PSE200A

PSE300A

PSE300AC

PSE300A Series

Dimensions

Panel fitting dimensions

Individual mounting

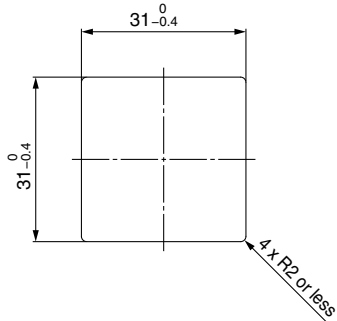

Multiple (2 pcs. or more) secure mounting <Horizontal>

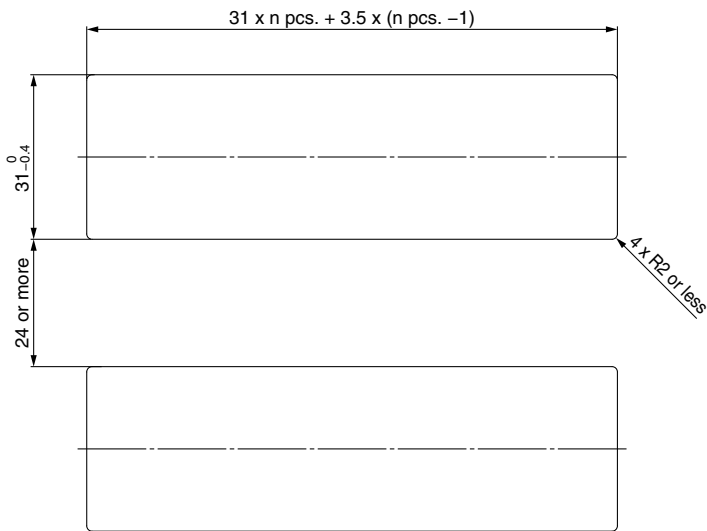

Panel mount example <Horizontal>

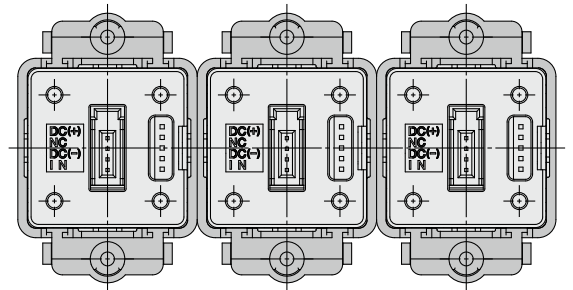

<Vertical>

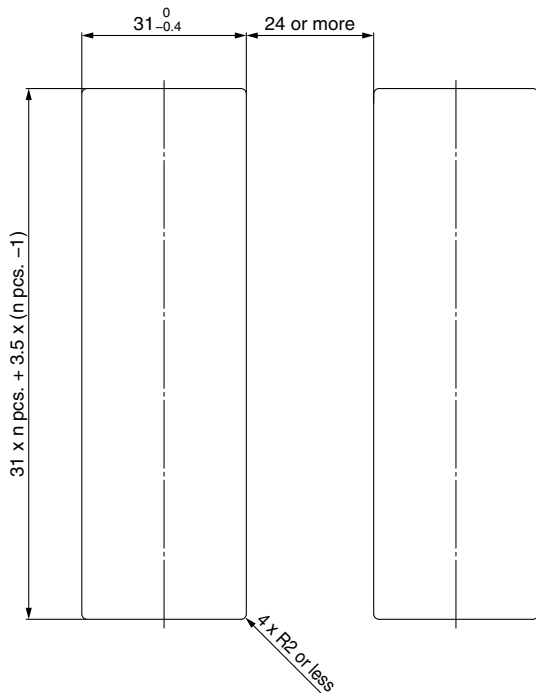

Panel mount example <Vertical>

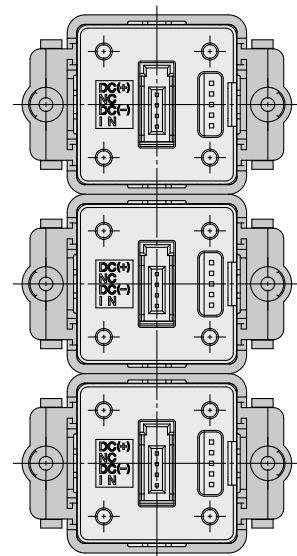

3-Screen Display Sensor Monitor PSE300AC Series



IP65

Applicable sensors					Rated pressure range					Set/Display resolution
PSE53□	PSE54□	PSE55□	PSE56□	PSE57□	-100 kPa	0	100 kPa	500 kPa	1 MPa 10 MPa	
PSE531	PSE541	—	PSE561	—	-101 kPa	0				0.1 kPa
PSE533	PSE543	—	PSE563	PSE573	-100 kPa		100 kPa			0.2 kPa
PSE530	PSE540	—	PSE560	PSE570		0			1 MPa	0.001 MPa
—	—	—	—	PSE575		0			2 MPa	0.001 MPa
—	—	—	—	PSE576		0			5 MPa	0.01 MPa
—	—	—	—	PSE577		0			10 MPa	0.01 MPa
PSE532	—	—	—	—		0	100 kPa			0.1 kPa
—	—	—	PSE564	PSE574		0		500 kPa		1 kPa
—	—	PSE550	—	—		0	2 kPa			0.01 kPa

It is possible to change the settings while checking the measured value.



Main screen

Measured value
(Current pressure value)

Sub screen

Label (Display item),
Set value (Threshold value)

Visualization of Settings

Set value
(Threshold value) P.1

Hysteresis value H.1

Delay time dt.1

Peak value H.H.

Bottom value H.Lo

- PSE530
- PSE540
- PSE550
- PSE560
- PSE570
- PSE200A
- PSE300A
- PSE300AC

3-Screen Display Sensor Monitor PSE300AC Series

● Visualization of Settings

The sub screen (label) shows the item to be set.

New PSE300AC

Current model



Mode Examples

Hysteresis mode

Normal output (Set value (Threshold value)) Reverse output (Set value (Threshold value))

P_1 0500 n_1 0500

Hysteresis (Set hysteresis value)

H_1 0050

Window comparator mode

Normal output/Lo side (Set value (Threshold value)) Normal output/Hi side (Set value (Threshold value))

P_L 0300 P_H 0600

Reverse output/Lo side (Set value (Threshold value)) Reverse output/Hi side (Set value (Threshold value))

n_L 0300 n_H 0600

● Easy Screen Switching

It is possible to change the settings while checking the measured value.

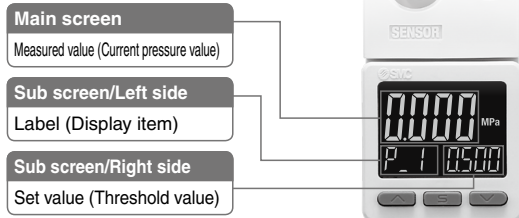

The sub screen can be switched by pressing the up/down buttons.

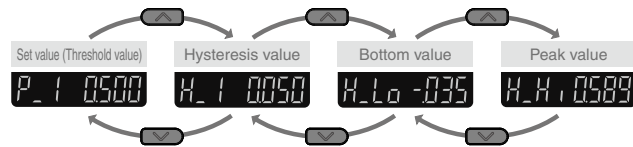

* One arbitrary display mode can be added via function settings.

● NPN/PNP Switch Function

The number of stock items can be reduced.

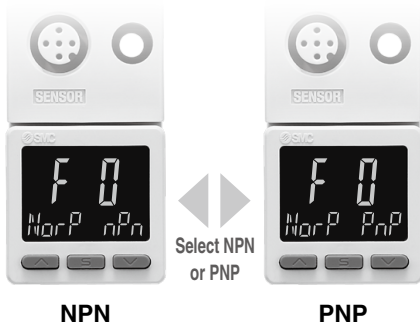

● Input Range Selection (for Pressure/Flow rate)

The sensor input range can be set to the required value and displayed.

(Voltage input: 1 to 5 V/Current input: 4 to 20 mA)

Pressure switch/Flow switch can be displayed.

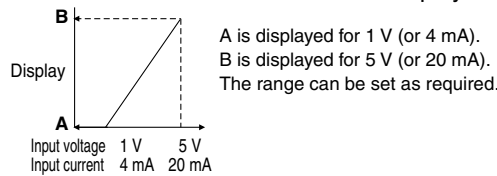

■ For Digital Flow Switch for Water/PF3W511

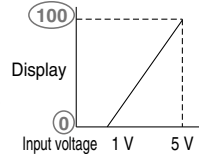
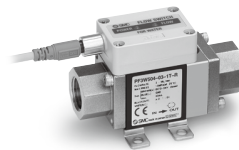

	A	B
PF3W504	0	4
PF3W520	0	16
PF3W540	0	40
PF3W511	0	100

Set A and B to the values shown in the table above.

● Simple 3-Step Setting

When the S button is pressed and the set value (P_1) is being displayed, the set value (threshold value) can be set.

When the S button is pressed and the hysteresis (H_1) is being displayed, the hysteresis value can be set.

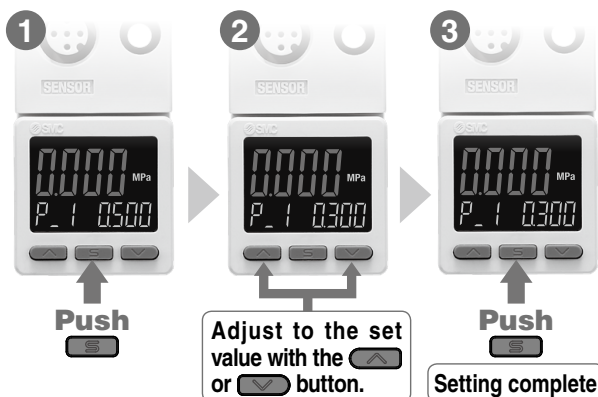

With a snapshot function for set value reading

Pressing the up and down buttons for a minimum of 1 second will make the set value (threshold value) the same as the current pressure value.

Snap shot function

Setting start

Release the buttons after "-" is displayed on the right side sub screen.

Setting complete

3-Screen Display Sensor Monitor

PSE300AC Series

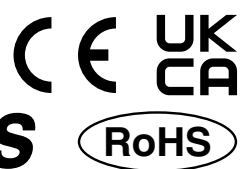

How to Order

PSE3 **0** 0AC - **AB** - **M** - **□**

Input specification

0	Voltage input
1	Current input

Output specification

AB 2 output type (NPN or PNP switching type)

Option (Power supply/Output lead wire)

Nil	Straight lead wire
L	Right angle lead wire
N	None

Options/Part Nos.

Description	Part no.	Note
Power supply/output lead wire	ZS-31-B	Straight (5 m) 1 pc.
	ZS-31-C	Right angle (5 m) 1 pc.

* For details on the lead wire with M12 connector and the assembly type connector for connecting to the sensor, refer to pages 24 and 25.

Unit specification

Nil	With unit selection function*1
M	SI unit only*2
P	With unit selection function (Initial value psi)*1

*1 Under the New Measurement Act, switches with a unit selection function are no longer allowed for use in Japan.

*2 Fixed unit: Pa, kPa, MPa

For pressure switch precautions and specific product precautions, refer to the "Operation Manual" on the SMC website.

Specifications

M12 Connector Type

Series		PSE300AC								
Applicable SMC pressure sensor		PSE550	PSE531/PSE541 PSE561	PSE533/PSE543 PSE563/PSE573	PSE532	PSE564 PSE574	PSE530/PSE540 PSE560/PSE570	PSE575	PSE576	PSE577
Rated pressure range		0 to 2 kPa	0 to -101 kPa	-100 to 100 kPa	0 to 100 kPa	0 to 500 kPa	0 to 1 MPa	0 to 2 MPa	0 to 5 MPa	0 to 10 MPa
Display/Set pressure range		-0.2 to 2.1 kPa	10 to -105 kPa	-105 to 105 kPa	-10 to 105 kPa	-50 to 525 kPa	-0.105 to 1.05 MPa	-0.105 to 2.1 MPa	-0.1 to 5.25 MPa	-0.1 to 10.5 MPa
Display/Smallest settable increment		0.001 kPa	0.1 kPa	0.1 kPa	0.1 kPa	0.1 kPa	1 kPa	0.001 MPa	0.001 MPa	0.01 MPa
Electrical	Power supply voltage	12 to 24 VDC (±10%) with 10% voltage ripple or less								
	Current consumption	25 mA or less								
	Protection	Reverse connection protection								
Accuracy	Display accuracy	±0.5% F.S. ±Min. display unit (Ambient temperature of 25°C)								
	Repeatability	±0.1% F.S. ±Min. display unit (Ambient temperature of 25°C)								
	Temperature characteristics	±0.5% F.S. (Ambient temperature of 0 to 50°C, 25°C reference)								
Switch output	Output type	Select from NPN or PNP open collector output.								
	Output mode	Select from hysteresis mode, window comparator mode, error output or switch output OFF.								
	Switch operation	Select from normal output or reverse output.								
	Max. load current	20 mA								
	Max. applied voltage (NPN only)	30 VDC								
	Internal voltage drop (Residual voltage)	1 V or less (with load current of 20 mA)								
	Delay time *1	1 ms or less (with anti-chattering function: 20, 100, 500, 1000, 2000, 5000 ms)								
	Hysteresis	Variable from 0*2								
Sensor input	Protection	Over current protection								
	Input type	Voltage input: 1 to 5 VDC (Input impedance: 1 MΩ), Current input: 4 to 20 mA DC (Input impedance: 51 Ω)								
	Number of inputs	1 input								
	Connection method	M12-4 pin connector								
Display	Protection	Over voltage protection (up to a voltage of 26.4 VDC)								
	Unit *3	MPa, kPa, Pa, kgf/cm ² , bar, mbar, psi, inHg, mmHg, mmH ₂ O								
	Display type	LCD								
	Number of screens	3-screen display (Main screen, Sub screen x 2)								
	Display color	1) Main screen: Red/Green, 2) Sub screen: Orange								
	Number of display digits	1) Main screen: 4-digit (7-segment), 2) Sub screen: 4-digit (Upper 1-digit 11-segment, 7-segment for other)								
Digital filter *4	Indicator light	Lights up when switch output is turned ON. OUT1/OUT2: Orange								
		0, 10, 50, 100, 500, 1000, 5000 ms								
Environment	Enclosure	IP65								
	Withstand voltage	1000 VAC for 1 min between terminals and housing								
	Insulation resistance	50 MΩ or more (500 VDC measured via megohmmeter) between terminals and housing								
	Operating temperature range	Operating: 0 to 50°C, Stored: -10 to 60°C (No freezing or condensation)								
Standards	Operating humidity range	Operating/Stored: 35 to 85% RH (No condensation)								
		CE/UKCA								
Weight		55.4 g (without power supply or output lead wires)								

*1 Value without digital filter (at 0 ms)

*2 If the applied pressure fluctuates around the set value, the hysteresis must be set to a value more than the amount of fluctuation, or chattering will occur.

*3 This setting is only available for models with the unit selection function. Only MPa, kPa, or Pa is available for models without this function.

*4 The response time indicates when the set value is 90% in relation to the step input.

PSE530
PSE540
PSE550
PSE560
PSE570
PSE200A
PSE300A
PSE300AC

Digital Sensor Monitors

PSE300AC Series

Internal Circuits and Wiring Examples

Setting of NPN open collector 2 outputs: Pressure sensor 3-wire type

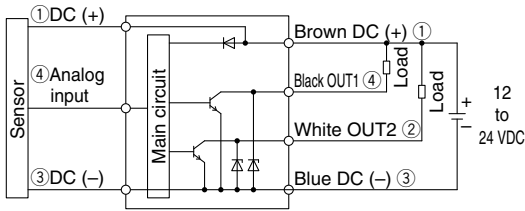

Setting of PNP open collector 2 outputs: Pressure sensor 3-wire type

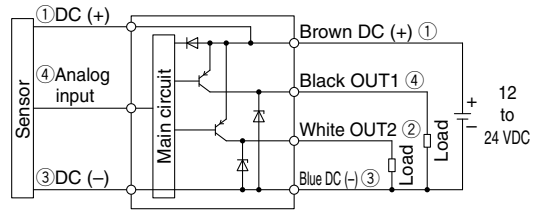

Setting of NPN open collector 2 outputs: Pressure sensor 2-wire type

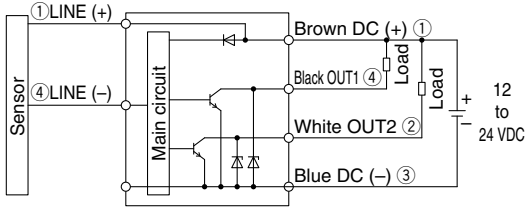

Setting of PNP open collector 2 outputs: Pressure sensor 2-wire type

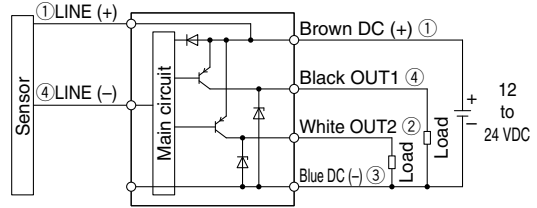

* The output type can be changed in the function selection mode.
* Numbers in the figures show the connector pin layout.

Dimensions

Power supply/Output connector pin no.

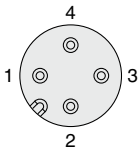

Pin no.	Description
1	DC (+)
2	OUT2
3	DC (-)
4	OUT1

Sensor connector pin no.

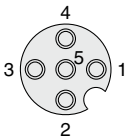

Pin no.	Description
1	DC (+)
2	N.C.
3	DC (-)
4	Sensor input (1 to 5 V, 4 to 20 mA)
5	N.C.

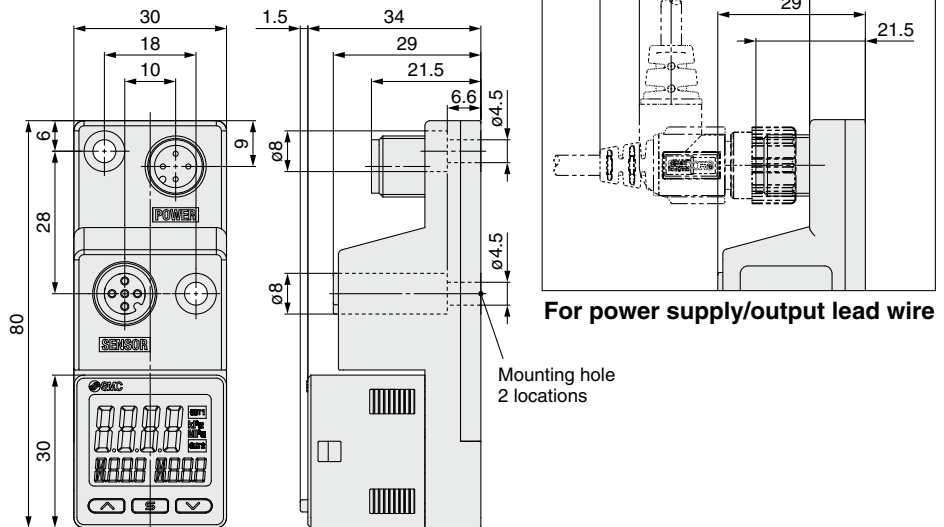

For power supply/output lead wire

Power supply/Output lead wire ZS-31-B

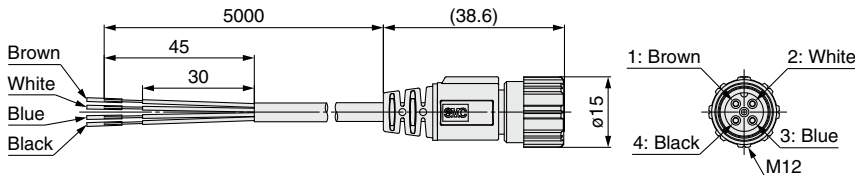

ZS-31-C

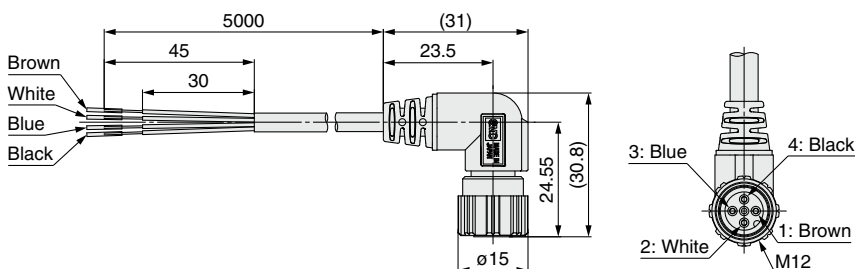

Cable Specifications

Conductor	Nominal cross section	AWG23
	Outside diameter	0.72 mm
Insulator	Material	Cross-linked vinyl chloride
	Outside diameter	1.14 mm
	Number of cores	4
Sheath	Material	Oil resistant vinyl chloride
	Finished outside diameter	φ4

Pin no.	Lead wire color	Description
1	Brown	DC (+)
2	White	OUT2
3	Blue	DC (-)
4	Black	OUT1

Options / Connection Examples

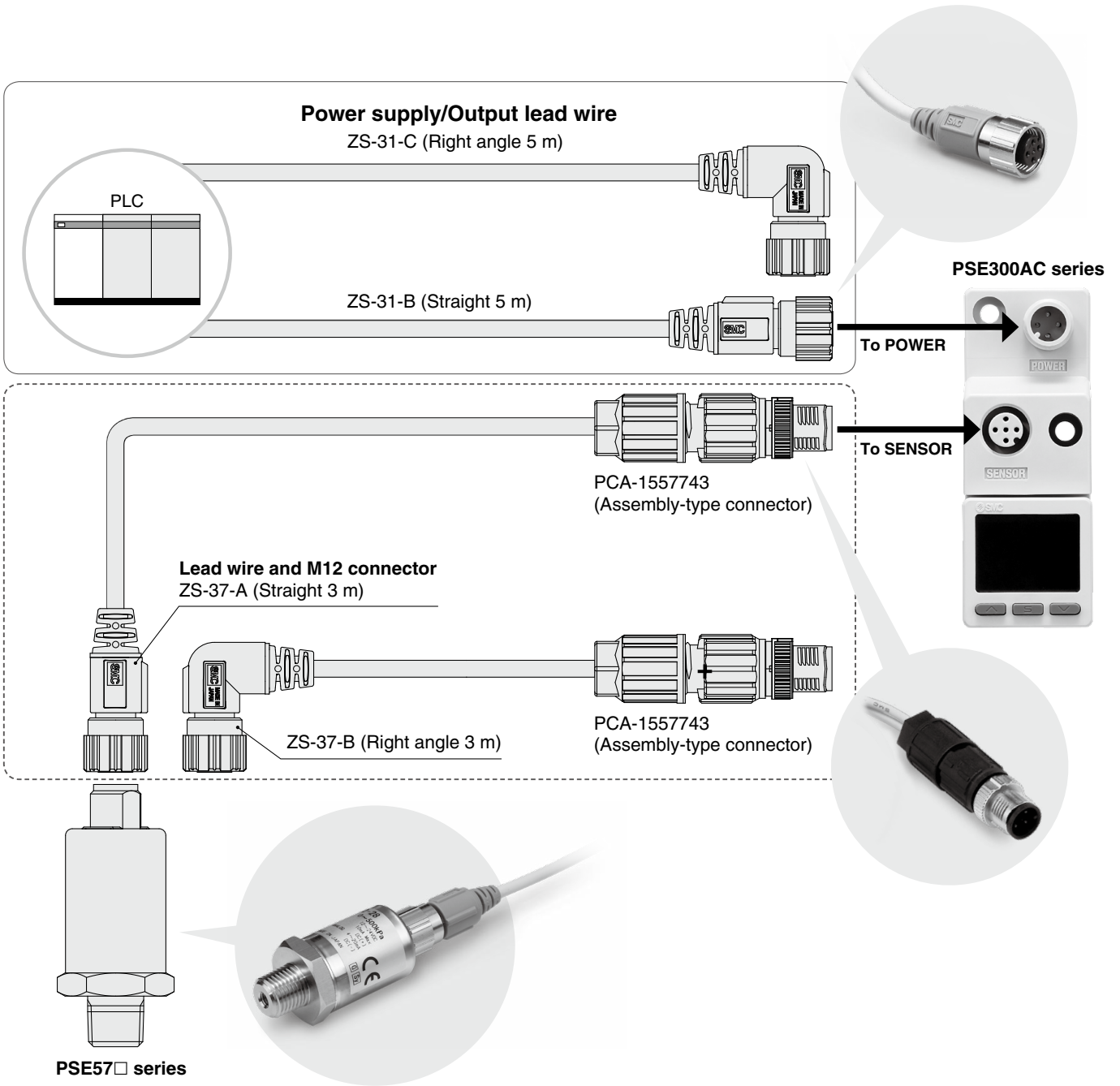

- PSE530
- PSE540
- PSE550
- PSE560
- PSE570
- PSE200A
- PSE300A
- PSE300AC

Lead wire and M12 connector + Assembly-type connector
Set part no.

ZS-37-A-X448	Straight 3 m	One lead wire with M12 connector and one assembly type connector are shipped together. (Not assembled)
ZS-37-B-X449	Right angle 3 m	

Safety Instructions

These safety instructions are intended to prevent hazardous situations and/or equipment damage. These instructions indicate the level of potential hazard with the labels of “**Caution**,” “**Warning**” or “**Danger**.” They are all important notes for safety and must be followed in addition to International Standards (ISO/IEC)*1), and other safety regulations.

 **Danger :** **Danger** indicates a hazard with a high level of risk which, if not avoided, will result in death or serious injury.

 **Warning:** **Warning** indicates a hazard with a medium level of risk which, if not avoided, could result in death or serious injury.

 **Caution:** **Caution** indicates a hazard with a low level of risk which, if not avoided, could result in minor or moderate injury.

*1) ISO 4414: Pneumatic fluid power - General rules and safety requirements for systems and their components
ISO 4413: Hydraulic fluid power - General rules and safety requirements for systems and their components
IEC 60204-1: Safety of machinery - Electrical equipment of machines - Part 1: General requirements
ISO 10218-1: Robots and robotic devices - Safety requirements for industrial robots - Part 1: Robots etc.

Warning

1. The compatibility of the product is the responsibility of the person who designs the equipment or decides its specifications.

Since the product specified here is used under various operating conditions, its compatibility with specific equipment must be decided by the person who designs the equipment or decides its specifications based on necessary analysis and test results. The expected performance and safety assurance of the equipment will be the responsibility of the person who has determined its compatibility with the product. This person should also continuously review all specifications of the product referring to its latest catalog information, with a view to giving due consideration to any possibility of equipment failure when configuring the equipment.

2. Only personnel with appropriate training should operate machinery and equipment.

The product specified here may become unsafe if handled incorrectly. The assembly, operation and maintenance of machines or equipment including our products must be performed by an operator who is appropriately trained and experienced.

3. Do not service or attempt to remove product and machinery/equipment until safety is confirmed.

1. The inspection and maintenance of machinery/equipment should only be performed after measures to prevent falling or runaway of the driven objects have been confirmed.
2. When the product is to be removed, confirm that the safety measures as mentioned above are implemented and the power from any appropriate source is cut, and read and understand the specific product precautions of all relevant products carefully.
3. Before machinery/equipment is restarted, take measures to prevent unexpected operation and malfunction.

4. Our products cannot be used beyond their specifications. Our products are not developed, designed, and manufactured to be used under the following conditions or environments. Use under such conditions or environments is not covered.

1. Conditions and environments outside of the given specifications, or use outdoors or in a place exposed to direct sunlight.
2. Use for nuclear power, railways, aviation, space equipment, ships, vehicles, military application, equipment affecting human life, body, and property, fuel equipment, entertainment equipment, emergency shut-off circuits, press clutches, brake circuits, safety equipment, etc., and use for applications that do not conform to standard specifications such as catalogs and operation manuals.
3. Use for interlock circuits, except for use with double interlock such as installing a mechanical protection function in case of failure. Please periodically inspect the product to confirm that the product is operating properly.

Caution

We develop, design, and manufacture our products to be used for automatic control equipment, and provide them for peaceful use in manufacturing industries.

Use in non-manufacturing industries is not covered.

Products we manufacture and sell cannot be used for the purpose of transactions or certification specified in the Measurement Act.

The new Measurement Act prohibits use of any unit other than SI units in Japan.

Limited warranty and Disclaimer/ Compliance Requirements

The product used is subject to the following “Limited warranty and Disclaimer” and “Compliance Requirements”.

Read and accept them before using the product.

Limited warranty and Disclaimer

1. The warranty period of the product is 1 year in service or 1.5 years after the product is delivered, whichever is first.*2)
Also, the product may have specified durability, running distance or replacement parts. Please consult your nearest sales branch.
2. For any failure or damage reported within the warranty period which is clearly our responsibility, a replacement product or necessary parts will be provided.
This limited warranty applies only to our product independently, and not to any other damage incurred due to the failure of the product.
3. Prior to using SMC products, please read and understand the warranty terms and disclaimers noted in the specified catalog for the particular products.

*2) **Vacuum pads are excluded from this 1 year warranty.**

A vacuum pad is a consumable part, so it is warranted for a year after it is delivered. Also, even within the warranty period, the wear of a product due to the use of the vacuum pad or failure due to the deterioration of rubber material are not covered by the limited warranty.

Compliance Requirements

1. The use of SMC products with production equipment for the manufacture of weapons of mass destruction (WMD) or any other weapon is strictly prohibited.
2. The exports of SMC products or technology from one country to another are governed by the relevant security laws and regulations of the countries involved in the transaction. Prior to the shipment of a SMC product to another country, assure that all local rules governing that export are known and followed.

Revision History

Edition B	* A DIN rail/terminal block type and current input type have been added to the PSE300 series.	LT
Edition C	* The PSE570 series pressure sensor for general fluids has been added. * The number of pages has been decreased from 40 to 36.	TT
Edition D	* An IO-Link compatible switch output specification has been added to the PSE540 series. * An IO-Link compatible switch output specification has been added to the PSE570 series. * The number of pages has been increased from 36 to 60.	

 **Safety Instructions** Be sure to read the “Handling Precautions for SMC Products” (M-E03-3) and “Operation Manual” before use.

SMC Corporation