

Low Air Consumption Booster Regulator

New

RoHS

Size: 10A, 20A

Air consumption **Max. 40% reduction** ^{*1}

^{*1} Based on SMC's measuring conditions

• 3 piston construction

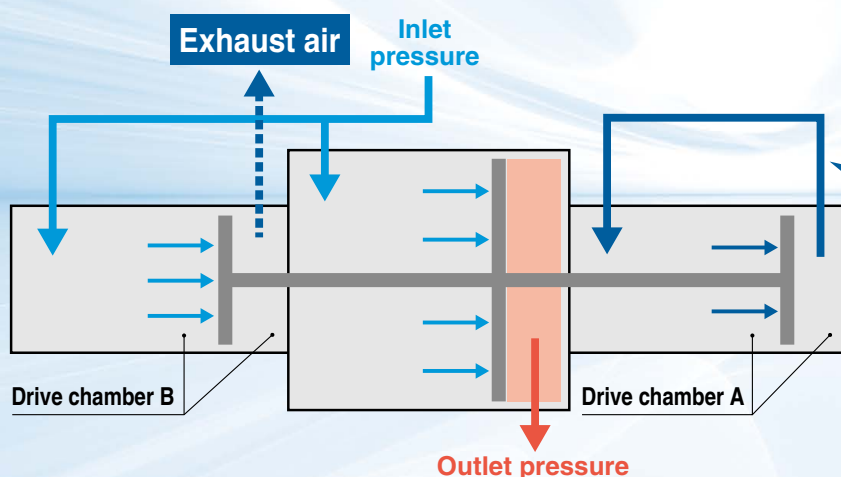

The air consumption of the drive chamber on one side (A or B) is "0."

Operates by recycling air through the exhaust return circuit

Operation noise: 65 dB (A)

^{*} Based on SMC's measuring conditions
^{*} For size 10A

15 dB (A) reduction compared with the existing model (VBA series)

- Exhaust noise:
Reduced noise due to exhaust of reused low-pressure air
- Metal noise:
Reduced noise due to the adoption of a construction in which the internal switching part doesn't come into contact with any metal parts

Charging time:

Max. 50% shorter

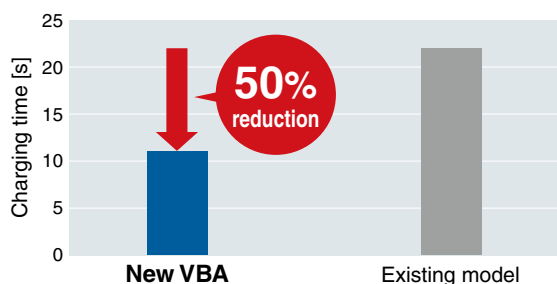

^{*} Inlet pressure: 0.4 MPa, Air tank: 10 L
^{*} For size 20A

Operating cycles:

50 million cycles or more

Maintenance frequency is reduced due to improved life.

^{*} Based on SMC's test conditions



VBA Series

CAT.ES11-115A

Simple, compact shape

- Built-in silencer
- No longer any need for a pressure regulator knob due to the fixed pressure increase ratio

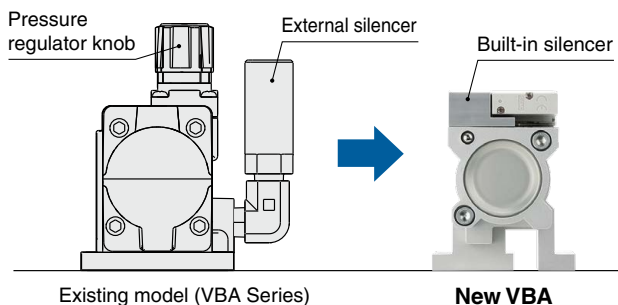

Pressure gauge attachable (OUT side)

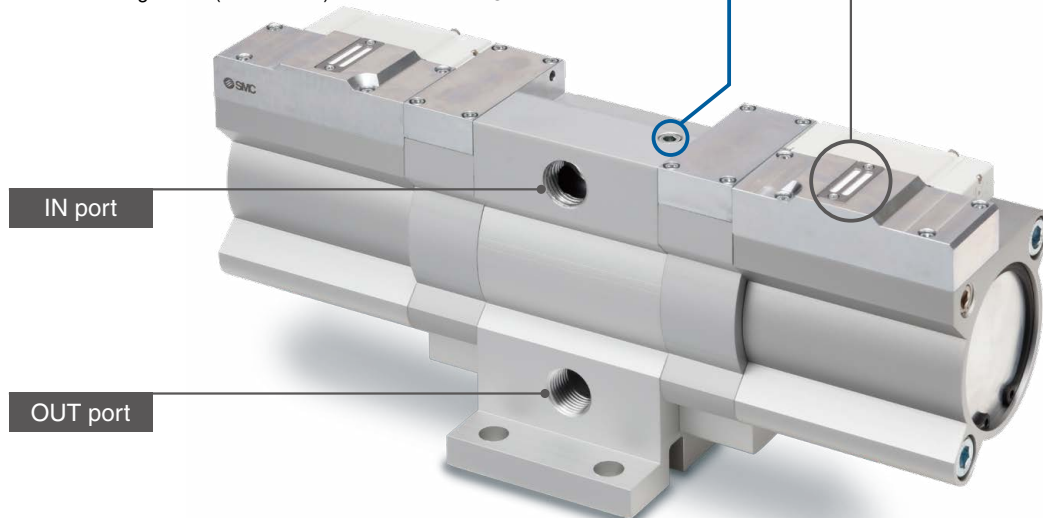

Built-in silencer

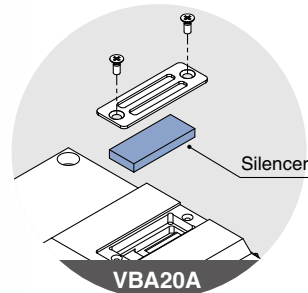
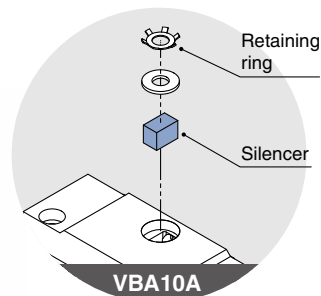

Compatible with vertical and horizontal installation

- Improved mounting flexibility

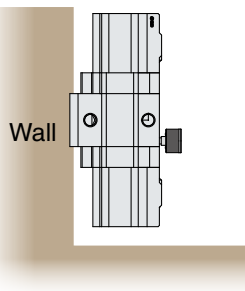

Auto switch can be attached on the rear side.

- Operating cycle count is possible using an auto switch. (VBA20A only)

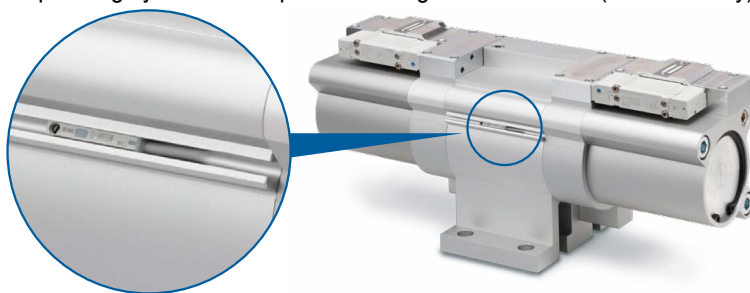

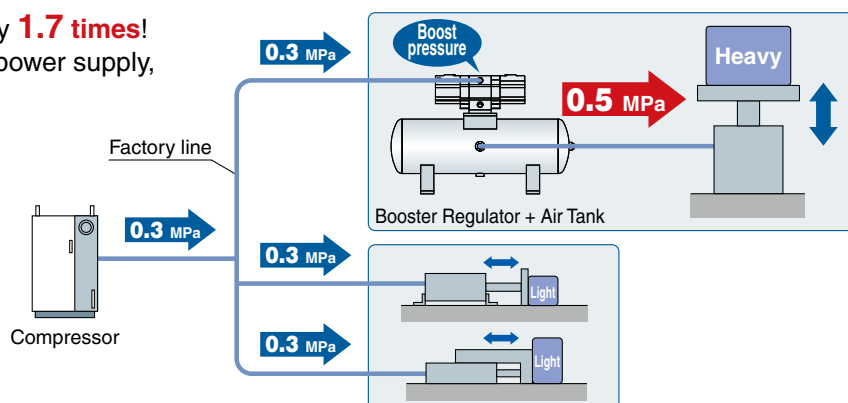

Mounting compatibility with the existing model (VBA series)

Increase factory air pressure by **1.7 times!**
Air-only operation requires no power supply, and allows easy installation.



Series Variations

Series	Model	Nominal size	Body size (Port size)	Pressure increase ratio	Max. flow rate [L/min (ANR)]	Set pressure [MPa]	Pressure adjustment mechanism (Operating method)	Installation
 <p>New Low air consumption booster regulator</p>	VBA-X3145	10A	1/4	1.7 times (Fixed)	230	0.3 to 1.2	Fixed type (Without pressure adjustment mechanism)	Horizontal Vertical
		20A	1/2		1000	0.3 to 1.2		
 <p>Booster regulator</p>	VBA-X3239	10A	1/4	2 times (Fixed)	250	0.4 to 1.4	Fixed type (Without pressure adjustment mechanism)	Horizontal Vertical
		11A		4 times (Fixed)	90	0.8 to 2.0		
 <p>Booster regulator</p>	VBA	10A	1/4	2 times	230	0.2 to 2.0	Knob-operated with relief mechanism	Horizontal
		20A	3/8		1000	0.2 to 1.0		
		40A	1/2		1900	0.2 to 1.0		
		22A	3/8	2 to 4 times	1000	0.2 to 1.0	Air-operated	
		42A	1/2		1900	0.2 to 1.0		
		43A	1/2		1600	0.2 to 1.6	Knob-operated with relief mechanism	
		11A	1/4		70	0.4 to 2.0		

CONTENTS

How to Order	p. 3	Working Principle	p. 7
Standard Specifications	p. 3	Circuit Example	p. 7
Options/Part Nos.	p. 3	Construction/Replacement Parts	p. 8
Flow Rate Characteristics, Charge Characteristics, Pulsation	p. 4	Dimensions	p. 9
Sizing	p. 5	Specific Product Precautions	p. 10

Low Air Consumption Booster Regulator

VBA Series

Size: 10A, 20A

RoHS

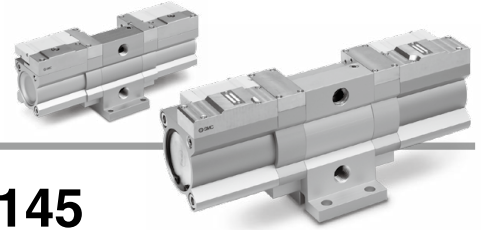

How to Order

VBA **10A** - **02** - X3145

Body size

10A	1/4
20A	1/2

Option

Symbol	Option	Body size	
		10A	20A
Nil	None	●	●
G	OUT side pressure gauge	●	●
B	Air tank mounting bolt	—	●
GB	OUT side pressure gauge + Air tank mounting bolt	—	●

Symbol

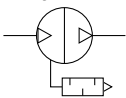

Port size

Symbol	Port size	Applicable model
02	Rc1/4	VBA10A
04	Rc1/2	VBA20A

Standard Specifications

Model	VBA10A	VBA20A
Fluid	Compressed air	
Pressure increase ratio	1.7 times (Fixed)	
Max. flow rate*1	[L/min (ANR)] 230	1000
Outlet pressure range	[MPa] 0.3 to 1.2	
Inlet pressure range	[MPa] 0.2 to 0.7	
Proof pressure	[MPa] 1.8	
Port size (IN, OUT)	[Rc] 1/4	1/2
OUT side gauge port	[Rc] 1/8	
Tank connection port (with plug)*2	1/4	1/2
Ambient and fluid temperatures [°C]	2 to 50 (No freezing)	
Installation	Horizontal, Vertical	
Lubrication	Grease (Non-lube)	
Weight	[kg] 1.2	5.1

*1 Flow rate at IN = OUT = 0.5 MPa. The pressure varies depending on the operating conditions. Refer to "Flow Rate Characteristics" on page 4.

*2 The tank connection port cannot be used for applications other than the connection with VBAT.

Options/Part Nos.

Pressure Gauge/For details on pressure gauge, refer to the [Web Catalog](#).

Model	VBA10A	VBA20A
Pressure gauge	G36-15-01	

Applicable Auto Switches/Refer to the [Web Catalog](#) for further information on auto switches.

Auto switch model	Electrical entry	Indicator light	Wiring (Output)	Load voltage		Applicable load	
				DC			
In-line	Grommet	Yes	3-wire (NPN)	24 V	5 V, 12 V	IC circuit	Relay, PLC
D-M9N							
D-M9P							
D-M9B			2-wire	12 V	—		

* Applicable auto switches can be ordered separately from the table shown above.

* Lead wire length symbols: 0.5 m Nil (Example) D-M9N
 1 m M (Example) D-M9NM
 3 m L (Example) D-M9NL
 5 m Z (Example) D-M9NZ

Solid line: Operating range

Operate so that the flow rate follows the solid line even when the outlet side air has been consumed.

Ex.) For the VBA10A: When the inlet pressure is 0.5 MPa and the set pressure is 0.8 MPa, operate at an outlet air flow rate of 100 L/min (ANR) or less.

P₁: Inlet pressure

P₂: Outlet pressure

VBA10A

Flow Rate Characteristics

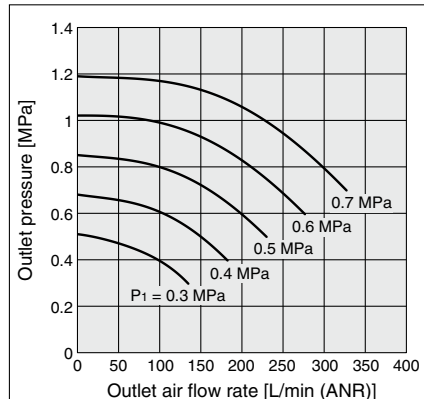

Charge Characteristics

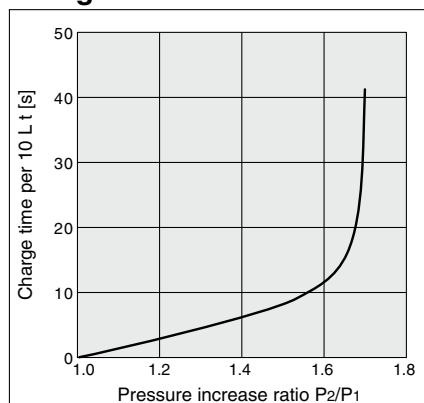

VBA10A

- The time required to charge pressure in the tank from 0.6 MPa to 0.8 MPa at 0.5 MPa supply pressure:

$$\frac{P_2}{P_1} = \frac{0.6}{0.5} = 1.2 \quad \frac{P_2}{P_1} = \frac{0.8}{0.5} = 1.6$$

With the pressure increase ratio from 1.2 to 1.6, the charge time of 12 - 4 = 8 s (t) is given by the graph. Then, the charge time (T) for a 10 L tank:

$$T = t \times \frac{V}{10} = 8 \times \frac{10}{10} = 8 \text{ (s)}$$

VBA20A

Flow Rate Characteristics

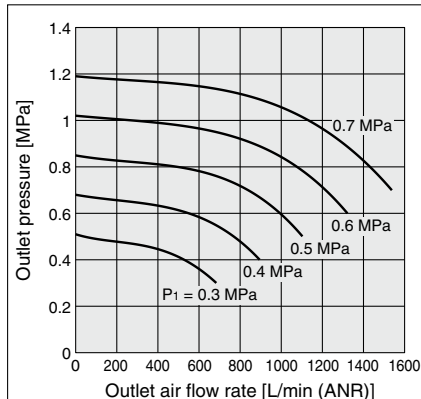

Charge Characteristics

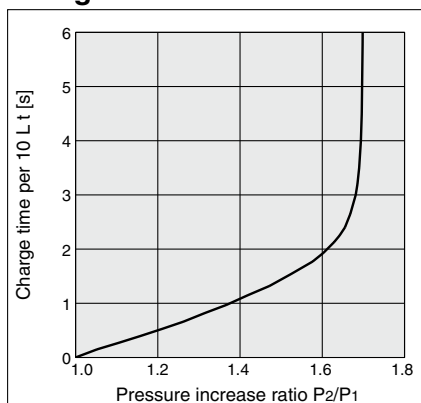

VBA20A

- The time required to charge pressure in the tank from 0.6 MPa to 0.8 MPa at 0.5 MPa supply pressure:

$$\frac{P_2}{P_1} = \frac{0.6}{0.5} = 1.2 \quad \frac{P_2}{P_1} = \frac{0.8}{0.5} = 1.6$$

With the pressure increase ratio from 1.2 to 1.6, the charge time of 1.9 - 0.5 = 1.4 s (t) is given by the graph. Then, the charge time (T) for a 100 L tank:

$$T = t \times \frac{V}{10} = 1.4 \times \frac{100}{10} = 14 \text{ (s)}$$

Pulsation/Pulsation is decreased with a tank.

If the outlet capacity is undersized, pulsation may occur.

VBAT05A

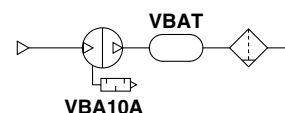
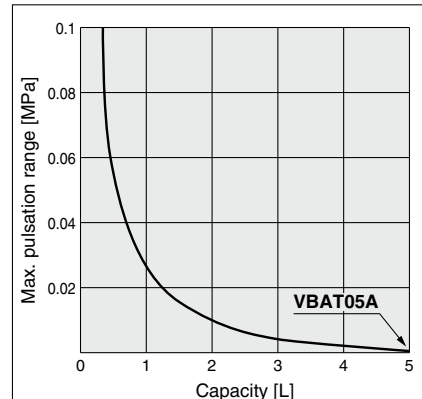

VBAT10A, VBAT20A, VBAT38A

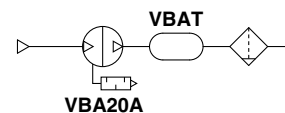
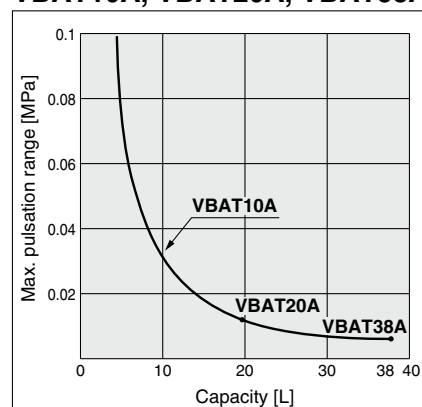

Conditions: Inlet pressure: 0.5 MPa
Outlet pressure: 0.85 MPa
Flow rate: Between 0 and max. flow rate

- Performance of air tank
 - Alleviates the pulsation generated on the outlet side.
 - When air consumption exceeds air supply during intermittent operation, required air will be accumulated in the tank for use.
- This does not apply for continuous operation.

VBA Series

Sizing (Please use the Booster Regulator Model Selection Software on the SMC website.)

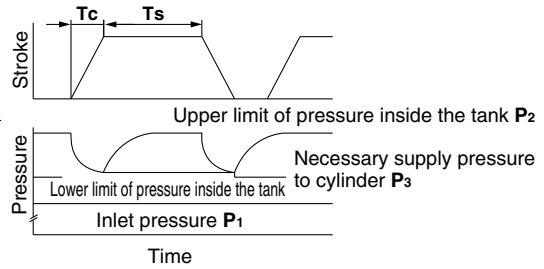
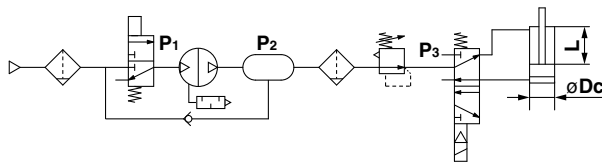

START

Provide requisite conditions for selection.

Necessary conditions:

- Dc** [mm]: Cylinder bore size
- Lc** [mm]: Cylinder stroke
- N** [pc.]: Number of cylinders
- Tc** [s]: Cylinder operating time
- Dt** [mm]: Piping bore (Valve-Cylinder)
- Lt** [mm]: Piping length (Valve-Cylinder)
- C** [cpm]: Operating frequency
- P1** [MPa]: Booster regulator inlet pressure
- P3** [MPa]: Necessary supply pressure for cylinder
- P2** [MPa]: Booster regulator outlet pressure (Set pressure)

- * **P3** is the necessary supply pressure to a cylinder, and set the pressure below the lower limit of pressure inside the tank with a regulator. Adjust the pressure taking the maximum operating pressure of equipment in use into consideration.
- * **P2** is the output pressure of the booster regulator, which is also the upper limit of charge pressure to the tank.

Other conditions:

- QAVE** [L/min]: Average air flow rate
- QMAX** [L/min]: Maximum instantaneous air flow rate
- K**: Cylinder double-acting: 2, single-acting: 1
- T1** [s]: Time to charge (Time to charge to **P3**)
- T2** [s]: Time to charge (Time to charge to **P2**)
- T** [s]: Time to charge (Time to charge from **P3** to **P2**)

Obtain the capacity (V).

Obtain the piping volume from the valve to the actuator and the volume of the actuator to obtain the air flow rate from the outlet side of the booster regulator.

Cylinder volume

$$V_{CYL} [L] = \frac{\pi \times Dc^2 \times Lc}{4 \times 10^6} \times \frac{P3 + 0.101}{0.101} \times N$$

Piping capacity

$$V_{TUBE} [L] = \frac{\pi \times Dt^2 \times Lt}{4 \times 10^6} \times \frac{P3}{0.101} \times N$$

Calculate air flow rate (Q).

Obtain the average air flow rate **QAVE** to select the size of the booster regulator.

Average air flow rate

$$Q_{AVE} [L/min (ANR)] = (V_{CYL} + V_{TUBE}) \times \frac{2}{T} \times C$$

(Reciprocation)

Obtain the maximum instantaneous air flow rate **QMAX** to check the necessity of an air tank.

Maximum instantaneous air flow rate

$$Q_{MAX} [L/min (ANR)] = \frac{(V_{CYL} + V_{TUBE})}{Tc} \times 60$$

Selection example	
Dc [mm]: 50	Lt [mm]: 500
Lc [mm]: 100	C [cpm]: 6
N [pc.]: 1	P1 [MPa]: 0.5
Tc [s]: 0.5	P3 [MPa]: 0.7
Dt [mm]: 4	P2 [MPa]: 0.85

$$V_{CYL} [L] = \frac{\pi \times 50^2 \times 100}{4 \times 10^6} \times \frac{0.7 + 0.101}{0.101} \times 1 = 1.55 [L]$$

$$V_{TUBE} [L] = \frac{\pi \times 4^2 \times 500}{4 \times 10^6} \times \frac{0.7}{0.101} \times 1 = 0.04 [L]$$

$$Q_{AVE} [L/min (ANR)] = (1.55 + 0.04) \times 2 \times 6 = 19 [L/min (ANR)]$$

$$Q_{MAX} [L/min (ANR)] = \frac{(1.55 + 0.04)}{0.5} \times 60 = 191 [L/min (ANR)]$$

Select the booster regulator and check the necessity of an air tank.

Select the booster regulator from the average air flow rate **QAVE** and check the necessity of an air tank from the maximum instantaneous air flow rate **QMAX**.

It can be used when the outlet air flow rate of the intersecting point between the booster regulator inlet pressure (**P1**) and necessary supply pressure to cylinder (**P3**) on the catalog flow characteristic table (p. 4) is equal to the average air flow rate **QAVE** or higher.

An air tank is required when the outlet air flow rate is less than the maximum instantaneous air flow rate **QMAX**.

An air tank is not required when the outlet air flow rate is at the maximum instantaneous air flow rate **QMAX** or higher.

⚠ Caution

- Since the booster regulator is a compressor powered by the air, it consumes the air. The air consumption is approximately 0.72 times larger than the outlet side volume. Therefore, the booster regulator requires a supply capacity of the inlet side volume that is approximately 1.72 times larger than the outlet side volume.

Selection example

P_1 : 0.5 [MPa], P_2 : 0.7 [MPa]
 Average air flow rate Q_{AVE} : 19 [L/min]
 Maximum instantaneous air flow rate Q_{MAX} : 191 [L/min]

Outlet air flow rate
VBA10A: 150 [L/min]
VBA20A: 800 [L/min]

VBA10A

Flow Rate Characteristics

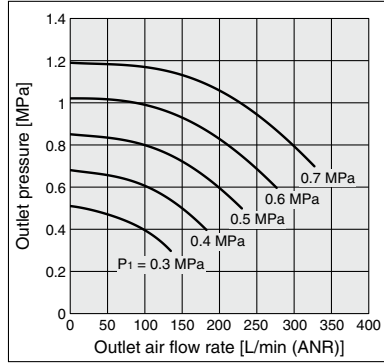

VBA20A

Flow Rate Characteristics

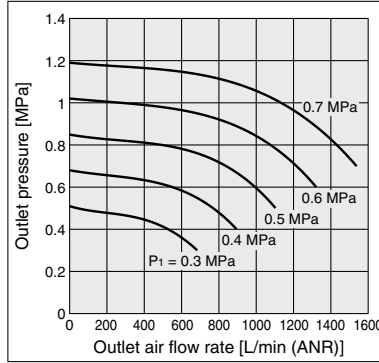

Results

The outlet air flow rate of **VBA10A** is equal to the average air flow rate Q_{AVE} or higher but it is less than the maximum instantaneous air flow rate Q_{MAX} . Therefore, it can be used but an air tank is required.

The outlet air flow rate of **VBA20A** is equal to the average air flow rate Q_{AVE} or higher and the maximum instantaneous air flow rate Q_{MAX} or higher. Therefore, it can be used without an air tank.

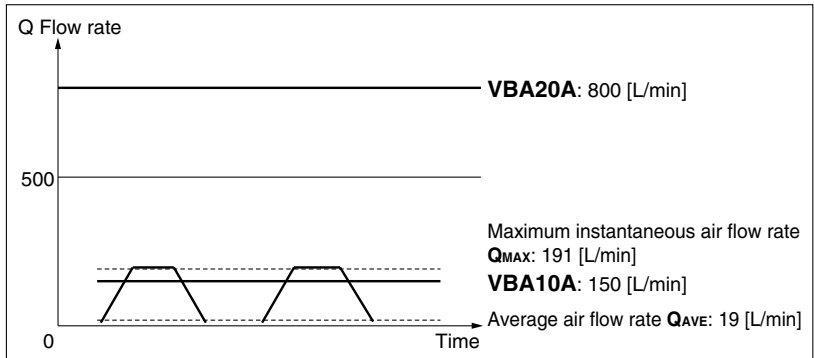

Booster regulator selection and air tank necessity confirmation results

Obtain the air tank capacity.

Obtain the air tank capacity.

$$V [L] = \frac{Q_{MAX}}{(P_2 - P_3) \times 9.9} \times \frac{T_c}{60} \times K$$

Check the air tank charge characteristics.

Obtain the time T from the catalog charge characteristics table (p. 4) and check that it satisfies the operating frequency.

$$T = \left(\frac{V}{10}\right) \times (T_2 - T_1) \leq \frac{60}{C}$$

Application example

$$T = \left(\frac{2.1}{10}\right) \times (40 - 6) = 7.1 \leq \frac{60}{6}$$

A tank smaller than the calculation results may satisfy the requirement since this size selection calculation provides calculation which is on the safe side. This does not consider air flowing from the booster regulator.

Please use the booster regulator model selection software on the SMC website.

Application example

Required air tank volume for **VBA10A**

$$V [L] = \frac{191}{(0.85 - 0.7) \times 9.9} \times \frac{0.5}{60} \times 2 = 2.1 [L]$$

* Air tank of 2.1 L or more is required.

VBA10A

Charge Characteristics

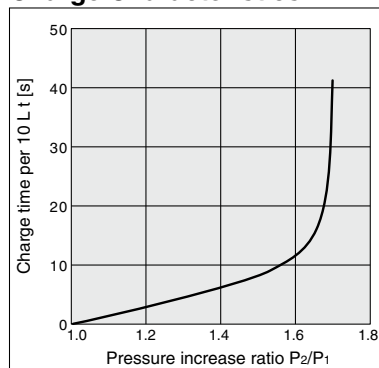

END

When running continuously for longer periods of time, confirm the life expectancy.
 When the life expectancy is shorter than required, select a larger sized booster regulator.

VBA Series

Working Principle

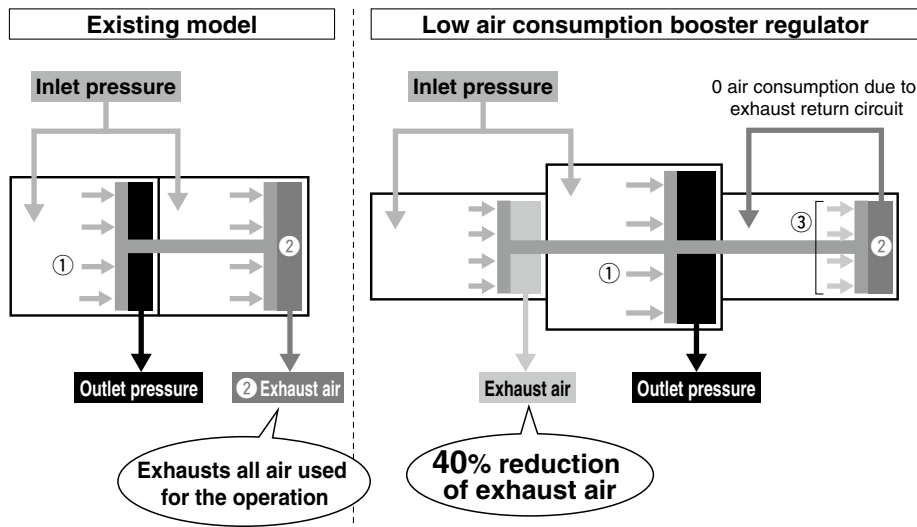

The existing model has two pistons and four chambers.

The inlet pressure enters two chambers and pushes the pistons in the arrow direction ① and outputs compressed air as outlet pressure. Simultaneously, the air in ② is exhausted when finished pushing the piston.

The low air consumption booster regulator has three pistons and six chambers.

The inlet pressure enters two chambers and pushes the pistons in the arrow direction ① and simultaneously, air ② that pushes the piston in the previous process is introduced in the next chamber by the exhaust return circuit, and it pushes the piston in the arrow direction ③.

The air that pushes the piston by exhaust return will be exhausted by the following process.

The existing model exhausted all air that pushes the pistons. However, the low air consumption booster regulator recycles air to operate the pistons, which reduces 40% of the exhaust air volume.

Circuit Example

- When only some of the machines in the factory require high-pressure air, booster regulators can be installed for only the equipment that requires it. This allows the overall system to use low-pressure air while accommodating machines requiring high-pressure air.

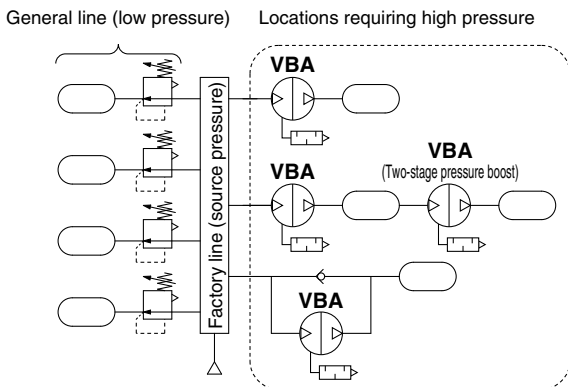

- When using two booster regulators for 2-stage pressure boost, be sure to supply sufficient flow to each booster regulator in order to stabilize the booster regulator inlet pressure. Refer to Selection 2. on page 10 for the inlet side supply amount.

- When charging a tank or the like from a source at atmospheric pressure, a circuit with a check valve can be used to reduce the charge time by allowing air to pass through the check valve up to the inlet pressure.

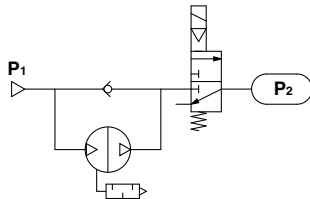

Initially, inlet pressure (P₁) passes through the check valve, fills P₂, and results in P₁ = P₂.

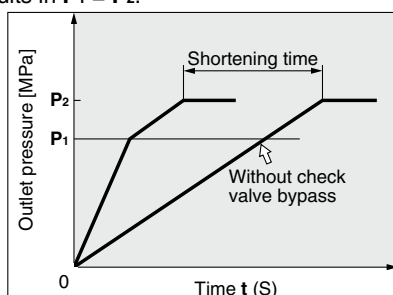

- When the actuator output is insufficient but space limitations prohibit switching to a larger cylinder diameter, a booster regulator can be used to increase the pressure. This makes it possible to boost the output without replacing the actuator.
- When a certain level of output is required but the cylinder size must be kept small so that the driver remains compact.

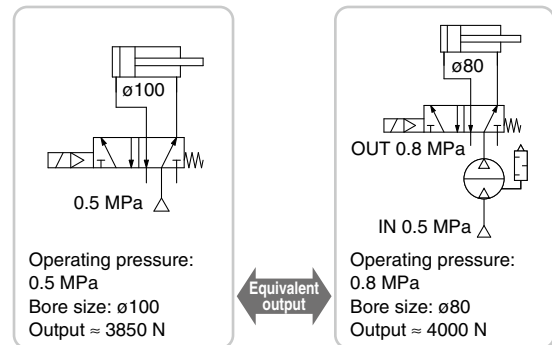

- When only one side of the cylinder is used for work, booster regulators can be installed only on the lines that require them to reduce the overall air consumption volume.

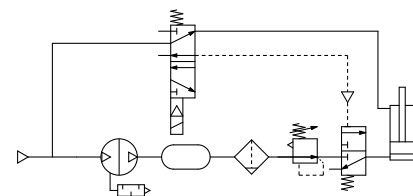

Construction/Replacement Parts

VBA10A, VBA20A

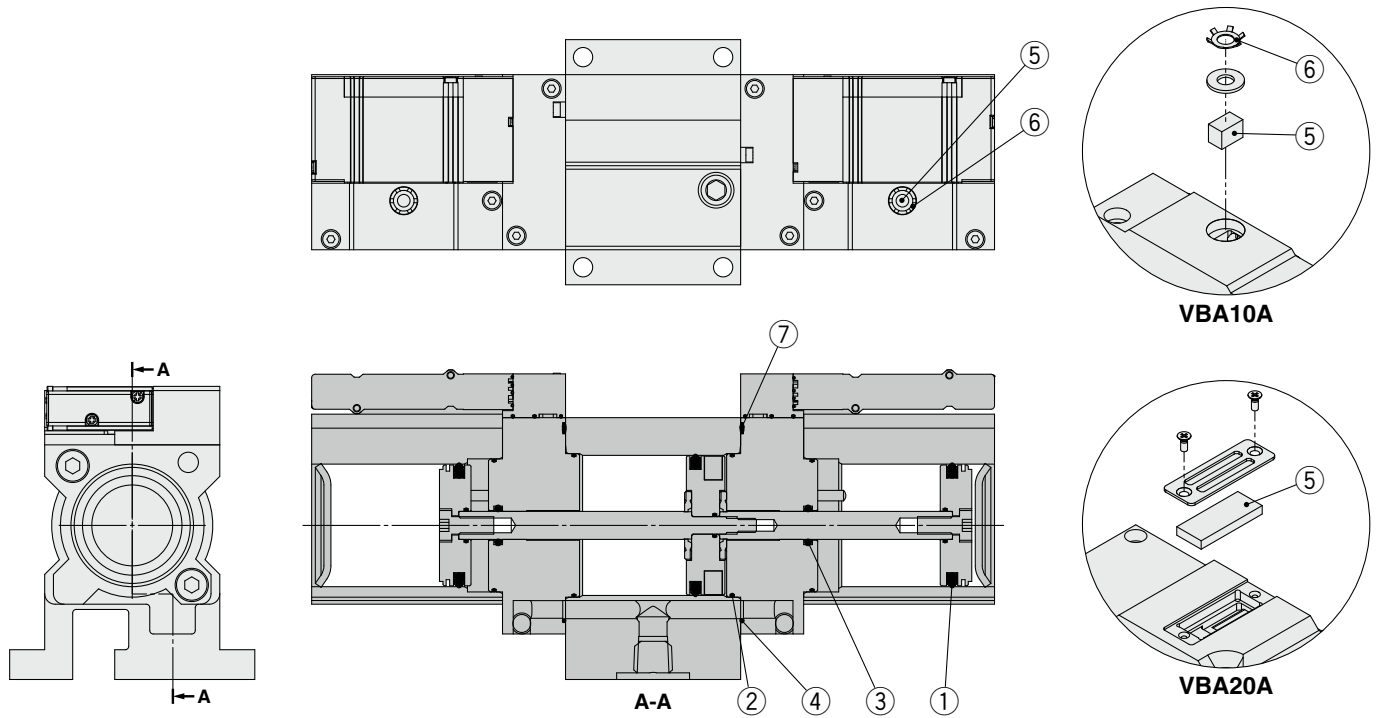

Replacement Parts/Kit No.

Place an order with the following applicable kit number.

Model	VBA10A	VBA20A
Kit no.	KT-VBA10A-X3145-1	KT-VBA20A-X3145-1

The kit includes the following parts and a grease pack.

No.	Description	Model	VBA10A	VBA20A
			Quantity	
1	Piston seal		1 large 2 small	
2	Tube gasket		2 large 2 small	
3	Rod seal		2	
4	O-ring		6	
5	Silencer		2	
6	Retaining ring		2	—
7	O-ring		5	
—	Check valve assembly		4	
—	Pilot valve assembly		2	
—	Grease pack		1	

* The grease pack has 10 g of grease.

* Make sure to refer to the procedure for maintenance.

* For details on the replacement parts kit, refer to the procedure for maintenance.

VBA Series

Dimensions

VBA10A

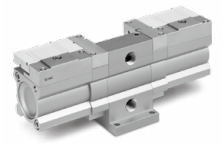
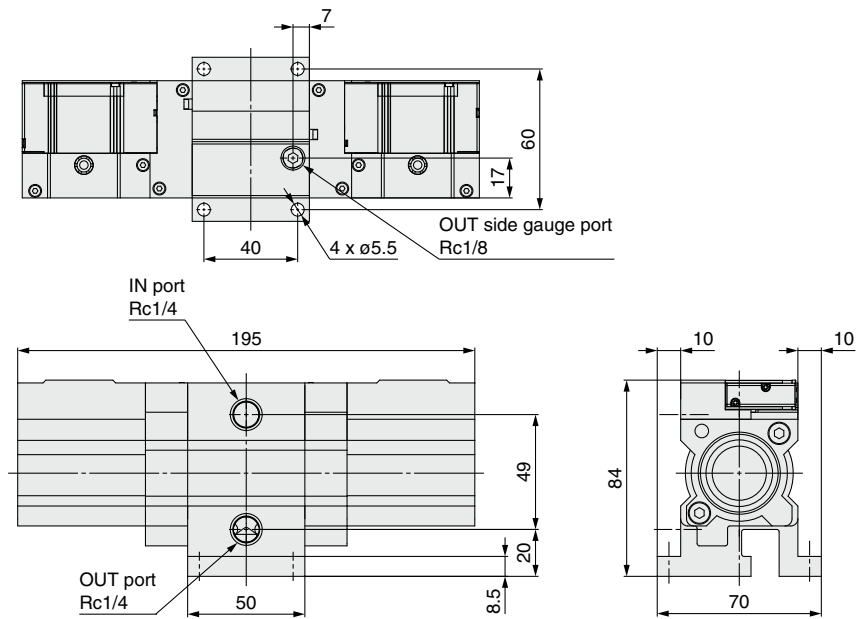

VBA20A

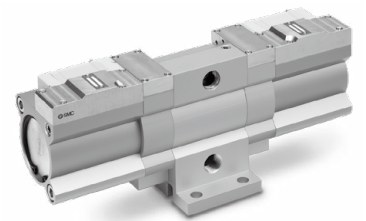
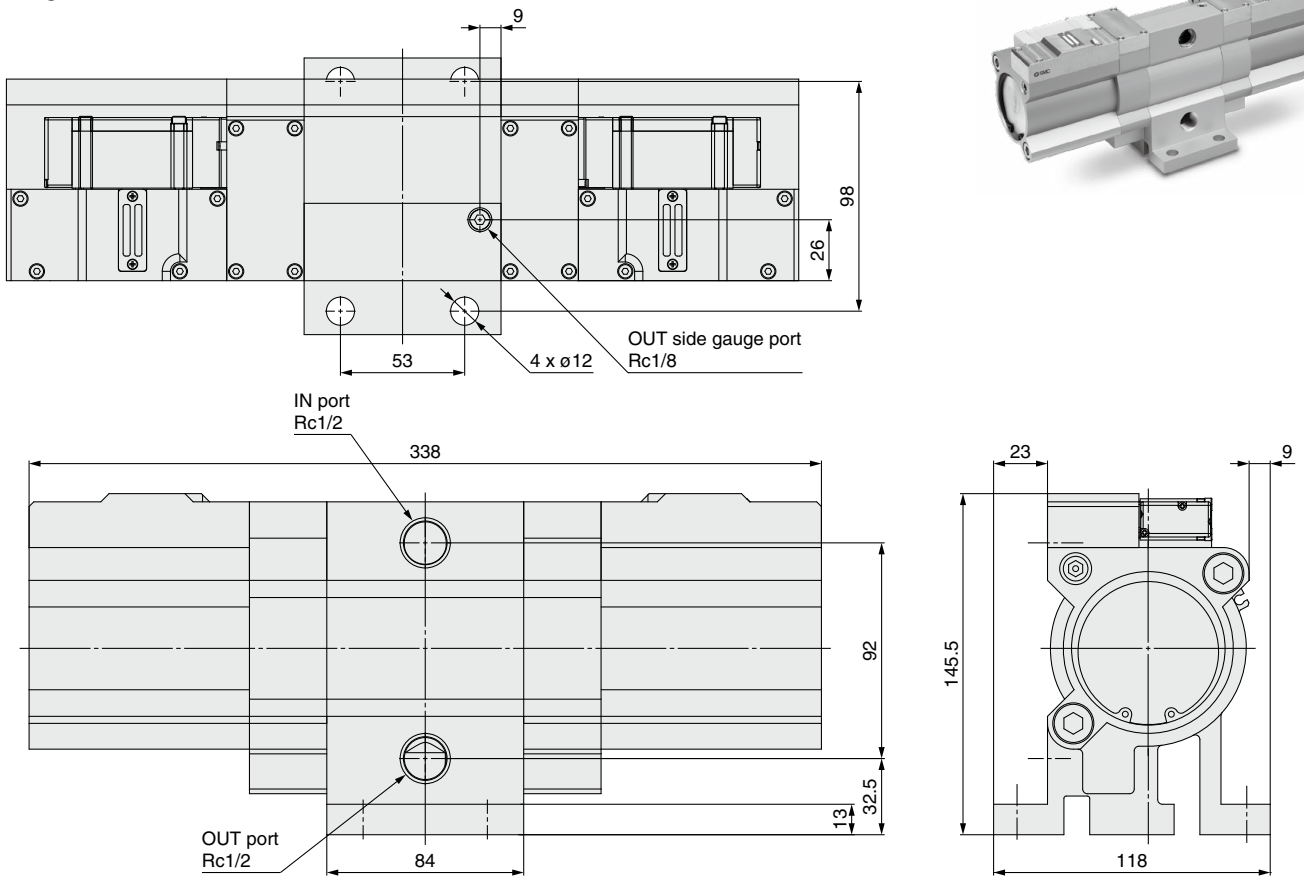



VBA Series

Specific Product Precautions 1

Be sure to read this before handling the products.
Refer to the back cover for safety instructions.

Design

⚠ Warning

1. Warning concerning abnormal outlet pressure

- If there is a likelihood of causing an outlet pressure drop due to unforeseen circumstances such as equipment malfunction, thus leading to a major problem, take safety measures on the system side.
- Because the outlet pressure could exceed its set range if there is a large fluctuation in the inlet pressure, leading to unexpected accidents, take safety measures against abnormal pressures.
- Use within the outlet pressure range.

2. Residual pressure measures

- Connect a 3-port valve to the OUT side of the booster regulator if the residual pressure must be released quickly from the outlet pressure side for maintenance, etc. (Refer to the diagram below.) The residual outlet pressure side cannot be released even if the 3-port valve is connected to the IN side because the check valve in the booster regulator will activate.

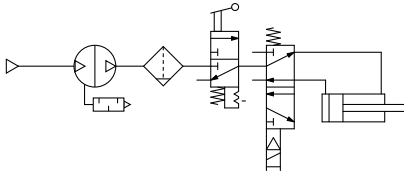

- Discharge the inlet charge pressure after the operation. It stops the operation of the booster regulator and prevents unnecessary air consumption.

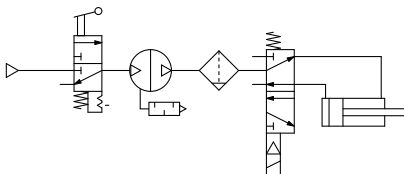

⚠ Caution

1. System configuration

- Ensure sufficient air charge capability of the minimum operating pressure (0.2 MPa) or more. The switching valve may not operate when the internal operating pressure is equal to the minimum operating pressure or less.
- The booster regulator has a sliding part inside, and it generates dust. Also, install an air purification device such as an air filter or a mist separator on the outlet side as necessary.
- Connect a lubricator to the outlet side, because the accumulated oil in the booster regulator may result in a malfunction.
- Pay attention to the maximum operating pressure range and operate within these specifications of peripheral equipment.

Design

⚠ Caution

2. Maintenance space

- Allow the sufficient space for maintenance and inspection.

3. Counting the operating cycle

- When counting the operating cycles using an auto switch, use an instrument with a counting speed of 1 kHz or more.

Selection

⚠ Caution

1. Check the specifications.

- Consider the operating conditions and operate this product within the specification range that is described in this catalog.

2. Selection

- Based on the conditions (such as pressure, flow rate, and cycle time) required for the outlet side of the booster regulator, check the selection procedures described in this catalog or model selection software for size selection of the booster regulator. Model selection can be done using the selection software on the SMC website. Go to Documents/Downloads → Model Selection Software → Booster Regulators
- Since the booster regulator is a compressor powered by the air, it consumes the air. The air consumption is approximately 0.72 times larger than the outlet side volume. Therefore, the booster regulator requires a supply capacity of the inlet side volume that is approximately 1.72 times larger than the outlet side volume.
- When operating the booster regulator continuously for longer periods of time, particularly confirm its service life.
- The service life of the booster regulator depends on not the operation hours but the operating cycles (piston sliding distance). The operating cycles (piston sliding distance) depend on the outlet air flow rate of the booster regulator. Thus, when more outlet air flow rate of the booster regulator is used, its service life becomes shorter. Selecting a booster regulator of a larger size will result in reduced operation frequency, thus increasing the service life of the product.
- When using two booster regulators for 2-stage pressure boost, be sure to provide a stable supply of pressure to the downstream booster regulator, and install a pressure vessel such as an air tank, etc., between the booster regulators. (Refer to the circuit diagram shown on page 7.)



VBA Series

Specific Product Precautions 2

Be sure to read this before handling the products.
Refer to the back cover for safety instructions.

Mounting

Caution

1. Transporting

- When transporting this product, hold it lengthwise with both hands.

2. Installation

- Tighten the mounting bolts for installation according to the table below since the piston vibration will transfer when installed.

Model	Bolt	Tightening torque
VBA10A	M5 x 0.8	3 N·m
VBA20A	M10 x 1.5	24 N·m

- If the transmission of vibration is not preferred, insert an isolating rubber material before installation.
- Mount the pressure gauge with a torque of 7 to 9 N·m.

Piping

Caution

1. Flushing

- Use an air blower to flush the piping to thoroughly remove any cutting chips, cutting oil, or debris from the piping inside, before connecting them. If they enter the inside of the booster regulator, they could cause the booster regulator to malfunction or its durability could be affected.

2. Piping size

- To bring the booster regulator's ability into full play, make sure to match the piping size to the port size.

Air Supply

Caution

1. Quality of air source

- Install an air filter on the upstream side of the booster regulator. Select an air filter with a filtration degree of 5 μm or finer.
- If dry air (atmospheric pressure dew point: -23°C or less) is used, the life expectancy may be shortened because dry air will accelerate evaporation of grease inside.

2. Pressure fluctuation

- Provide a stable supply of pressure for the inlet pressure.

Operating Environment

Caution

1. Installation location

- Do not install this product in an area that is exposed to rainwater or direct sunlight.
- Do not install in locations influenced by vibrations. If it must be used in such an area due to unavoidable circumstances, please contact SMC beforehand.

Handling

Caution

1. Draining

- If this product is used with a large amount of drainage accumulated in the filter or tank, the drainage could flow out, leading to equipment malfunction. Therefore, drain the system once a day. If it is equipped with an auto drain, check its operation once a day.

2. Maintenance

Booster regulator

- Life expectancy varies depending on the quality of air and the operating conditions.
Signs that the unit is reaching the end of its service life include the following:
 - Air exhaust noise can be heard from the booster regulator at 10 to 20 second intervals even when there is no air consumption on the outlet side.
 Conduct maintenance earlier than scheduled in such cases.
- Conduct maintenance according to the specified maintenance procedure by individuals possessing enough knowledge and experiences in maintaining pneumatic equipment.

Silencer

Discoloration or deterioration may occur due to turbine oil, grease and drainage in exhaust air and operating atmosphere. Please perform regular maintenance.

Safety Instructions

These safety instructions are intended to prevent hazardous situations and/or equipment damage. These instructions indicate the level of potential hazard with the labels of “**Caution**,” “**Warning**” or “**Danger**.” They are all important notes for safety and must be followed in addition to International Standards (ISO/IEC)*1), and other safety regulations.

 **Caution:** **Caution** indicates a hazard with a low level of risk which, if not avoided, could result in minor or moderate injury.

 **Warning:** **Warning** indicates a hazard with a medium level of risk which, if not avoided, could result in death or serious injury.

 **Danger :** **Danger** indicates a hazard with a high level of risk which, if not avoided, will result in death or serious injury.

*1) ISO 4414: Pneumatic fluid power – General rules relating to systems.
ISO 4413: Hydraulic fluid power – General rules relating to systems.
IEC 60204-1: Safety of machinery – Electrical equipment of machines.
(Part 1: General requirements)
ISO 10218-1: Manipulating industrial robots – Safety.
etc.

Warning

1. The compatibility of the product is the responsibility of the person who designs the equipment or decides its specifications.

Since the product specified here is used under various operating conditions, its compatibility with specific equipment must be decided by the person who designs the equipment or decides its specifications based on necessary analysis and test results. The expected performance and safety assurance of the equipment will be the responsibility of the person who has determined its compatibility with the product. This person should also continuously review all specifications of the product referring to its latest catalog information, with a view to giving due consideration to any possibility of equipment failure when configuring the equipment.

2. Only personnel with appropriate training should operate machinery and equipment.

The product specified here may become unsafe if handled incorrectly. The assembly, operation and maintenance of machines or equipment including our products must be performed by an operator who is appropriately trained and experienced.

3. Do not service or attempt to remove product and machinery/equipment until safety is confirmed.

1. The inspection and maintenance of machinery/equipment should only be performed after measures to prevent falling or runaway of the driven objects have been confirmed.
2. When the product is to be removed, confirm that the safety measures as mentioned above are implemented and the power from any appropriate source is cut, and read and understand the specific product precautions of all relevant products carefully.
3. Before machinery/equipment is restarted, take measures to prevent unexpected operation and malfunction.

4. Contact SMC beforehand and take special consideration of safety measures if the product is to be used in any of the following conditions.

1. Conditions and environments outside of the given specifications, or use outdoors or in a place exposed to direct sunlight.
2. Installation on equipment in conjunction with atomic energy, railways, air navigation, space, shipping, vehicles, military, medical treatment, combustion and recreation, or equipment in contact with food and beverages, emergency stop circuits, clutch and brake circuits in press applications, safety equipment or other applications unsuitable for the standard specifications described in the product catalog.
3. An application which could have negative effects on people, property, or animals requiring special safety analysis.
4. Use in an interlock circuit, which requires the provision of double interlock for possible failure by using a mechanical protective function, and periodical checks to confirm proper operation.

Caution

1. The product is provided for use in manufacturing industries.

The product herein described is basically provided for peaceful use in manufacturing industries.
If considering using the product in other industries, consult SMC beforehand and exchange specifications or a contract if necessary.
If anything is unclear, contact your nearest sales branch.

Limited warranty and Disclaimer/ Compliance Requirements

The product used is subject to the following “Limited warranty and Disclaimer” and “Compliance Requirements”.

Read and accept them before using the product.

Limited warranty and Disclaimer

1. The warranty period of the product is 1 year in service or 1.5 years after the product is delivered, whichever is first.*2)
Also, the product may have specified durability, running distance or replacement parts. Please consult your nearest sales branch.
2. For any failure or damage reported within the warranty period which is clearly our responsibility, a replacement product or necessary parts will be provided.
This limited warranty applies only to our product independently, and not to any other damage incurred due to the failure of the product.
3. Prior to using SMC products, please read and understand the warranty terms and disclaimers noted in the specified catalog for the particular products.

*2) Vacuum pads are excluded from this 1 year warranty.

A vacuum pad is a consumable part, so it is warranted for a year after it is delivered.
Also, even within the warranty period, the wear of a product due to the use of the vacuum pad or failure due to the deterioration of rubber material are not covered by the limited warranty.

Compliance Requirements

1. The use of SMC products with production equipment for the manufacture of weapons of mass destruction (WMD) or any other weapon is strictly prohibited.
2. The exports of SMC products or technology from one country to another are governed by the relevant security laws and regulations of the countries involved in the transaction. Prior to the shipment of a SMC product to another country, assure that all local rules governing that export are known and followed.

Caution

SMC products are not intended for use as instruments for legal metrology.

Measurement instruments that SMC manufactures or sells have not been qualified by type approval tests relevant to the metrology (measurement) laws of each country. Therefore, SMC products cannot be used for business or certification ordained by the metrology (measurement) laws of each country.

Safety Instructions

Be sure to read the “Handling Precautions for SMC Products” (M-E03-3) and “Operation Manual” before use.