



Compact Type Parallel Style Air Gripper

ø8, ø12, ø16, ø20

RoHS

New

Although downsized, gripping point is maintained. (ø20 → ø16)

Overall length

Max. **0.85** inch shorter (**21.7** mm shorter)
4.04 inch (102.7mm) → **3.19** inch (81mm)

Thickness

Max. **0.30** inch shorter (**7.6** mm shorter)
1.32 inch (33.6mm) → **1.02** inch (26mm)

Weight

Max. **6.35** ounce lighter (**180** g lighter)
14.81 ounce (420g) → **8.46** ounce (240g)

* When comparing ø25 of MHZ2 and ø20 of JMHZ2



High rigidity and precision are achieved by integrating the guide and finger in one piece.

With high-precision linear guide

Repeatability: **±0.0003937008** inch
(±0.01mm)

Linear guide of the higher rigidity and precision is used.

Higher rigidity

(compared with the same size of the existing MHZ2)



JMHZ2 Series

NAS20-262A

Compact Type Parallel Style Air Gripper *JMHZ2 Series*

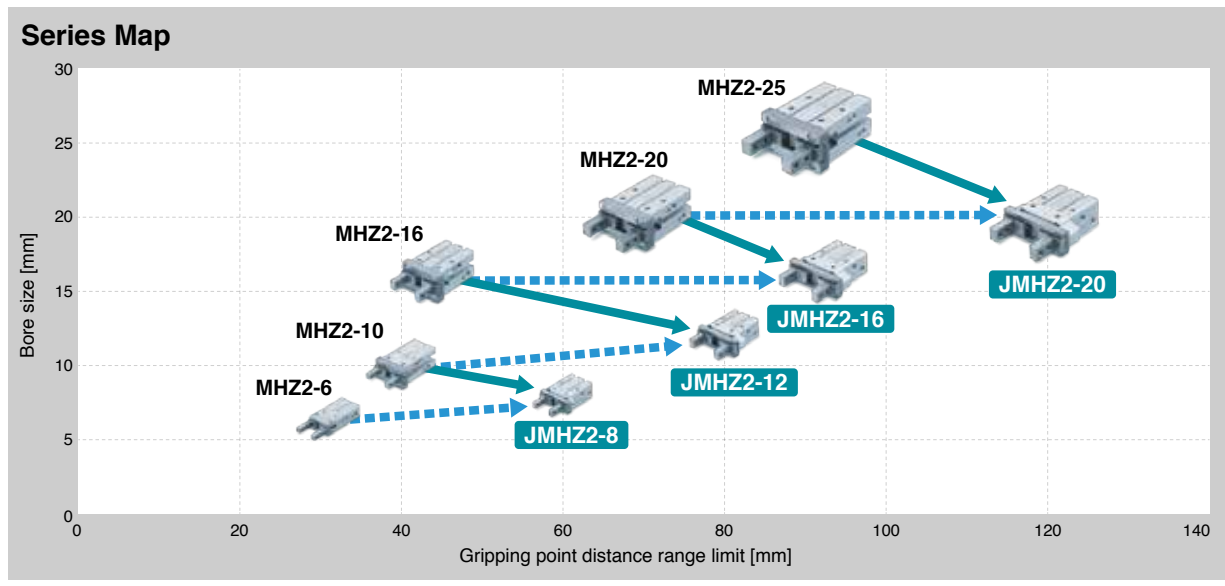

Downsizing

The same linear guide achieves one bore size smaller cylinder.

New JMHZ2-16D

Bore size **16 mm**

MHZ2-20D

Bore size **20 mm**

Downsizing of the body

Equivalent linear guide performance

JMHZ2	MHZ2
8	10
12	16
16	20
20	25

Compact and lightweight

Bore size	JMHZ2	MHZ2	Reduction
8	46.8	57	10.2
12	52	67.3	15.3
16	65.5	84.8	19.3
20	81	102.7	21.7

Bore size	JMHZ2	MHZ2	Reduction
8	13	16.4	3.4
12	17	23.6	6.6
16	20	27.6	7.6
20	26	33.6	7.6

Bore size [mm]	JMHZ2	MHZ2	Reduction
8	31	55	24
12	65	115	50
16	128	230	102
20	240	420	180

New JMHZ2

Existing model MHZ2

Thickness reduced

Thickness

Overall length reduced

Overall length

Guide performance is increased. Higher rigidity

- Linear guide equivalent to that of the larger bore size of the cylinder is used.
- Higher opening/closing stroke

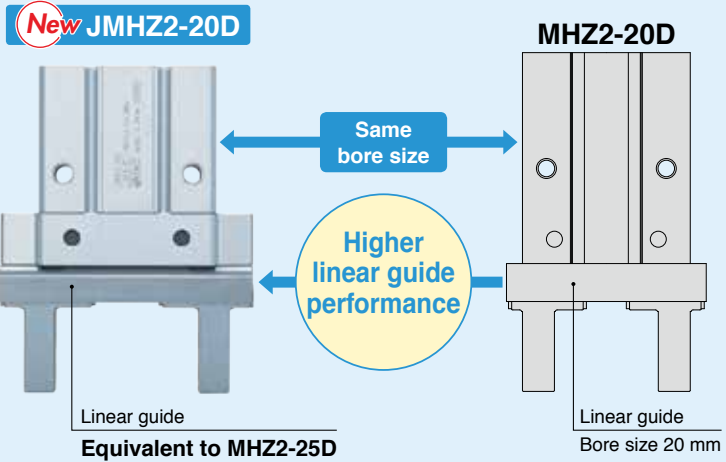

Linear guide

Model	Linear guide
JMHZ2-8D	Equivalent to MHZ2-10D
JMHZ2-12D	Equivalent to MHZ2-16D
JMHZ2-16D	Equivalent to MHZ2-20D
JMHZ2-20D	Equivalent to MHZ2-25D

Longer gripping point

Longer gripping point is possible in cylinder one bore smaller.

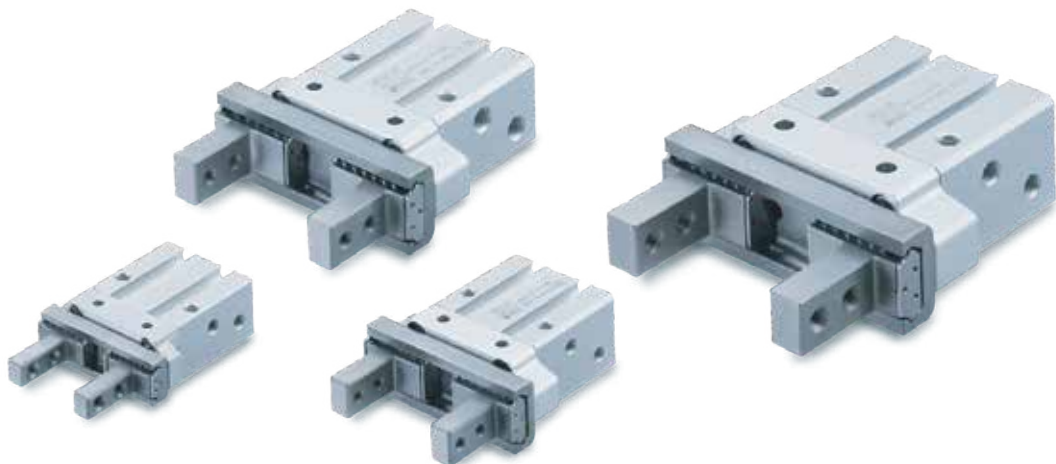
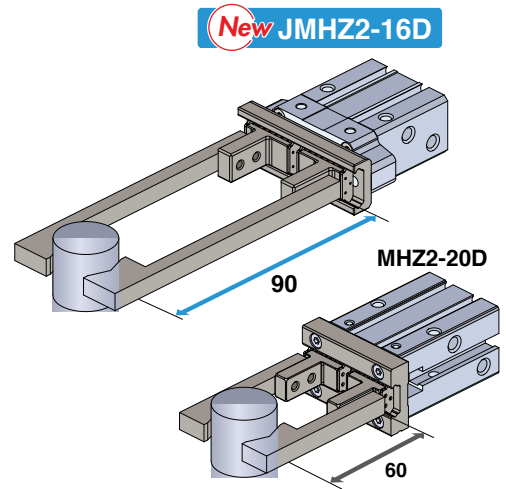
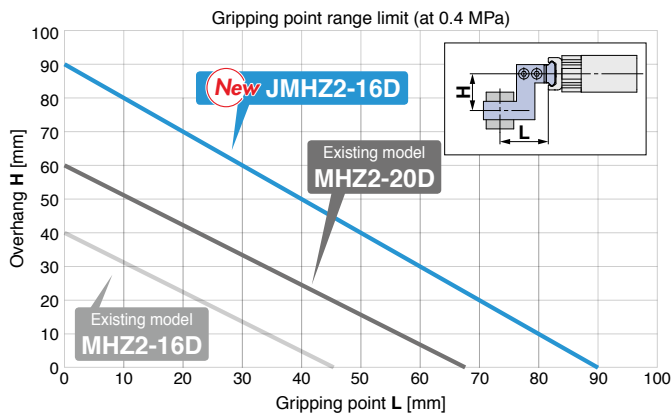

Compact Type Parallel Style Air Gripper *JMHZ2 Series*

High precision

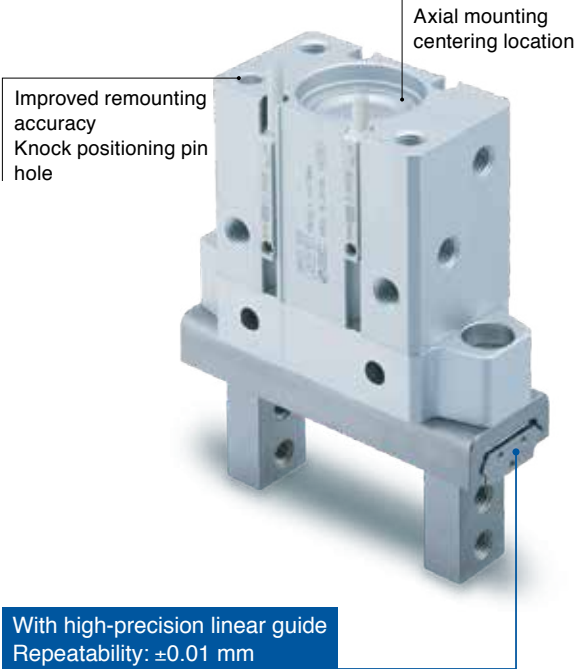

Linear guide

Model	Linear guide
JMHZ2-8D	Equivalent to MHZ2-10D
JMHZ2-12D	Equivalent to MHZ2-16D
JMHZ2-16D	Equivalent to MHZ2-20D
JMHZ2-20D	Equivalent to MHZ2-25D

High degree of mounting flexibility

Can be mounted 3 ways from 2 directions

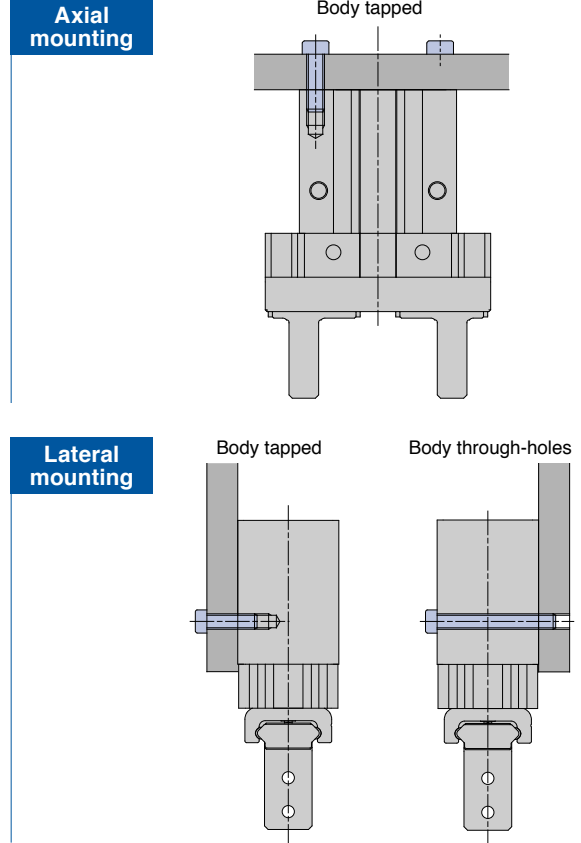

Finger options

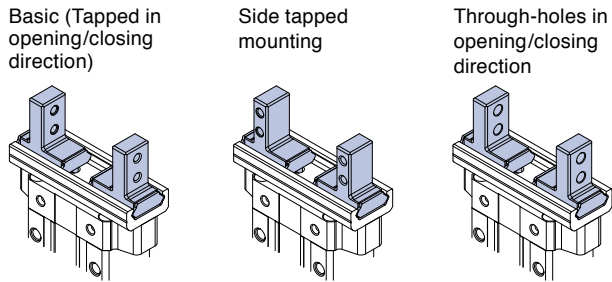

Compact auto switches are mountable.

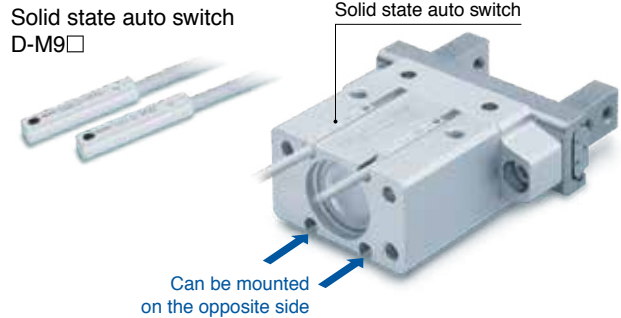

Series Variations

Series	Bore size [mm]	Action	Opening/Closing stroke (Both sides) [mm]	Mounting orientation	Finger option
Compact type JMHZ2 	8	Double acting	4	<ul style="list-style-type: none"> · Axial mounting · Lateral mounting 	<ul style="list-style-type: none"> · Basic (Tapped in opening/closing direction) · Side tapped mounting · Through-holes in opening/closing direction
	12		6		
	16		10		
	20		14		

Model Selection

Selection Procedure

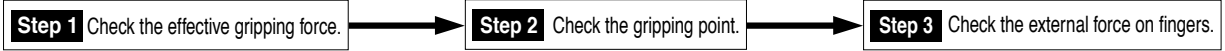

Step 1 Check the gripping force.



Example

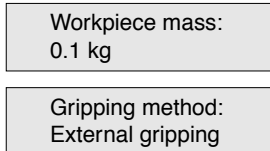

Guidelines for the selection of the gripper with respect to workpiece mass

- Although conditions differ according to the workpiece shape and the coefficient of friction between the attachments and the workpiece, select a model that can provide a gripping force of at least 10 to 20 times*1 greater than the workpiece weight.
- *1 For further details, refer to the model selection illustration.
- Further allowance should be provided when great acceleration or impact is expected during workpiece transfer.

Example) For setting the gripping force to be at least 20 times greater than the workpiece weight:
 Required gripping force = 0.1 kg x 20 x 9.8 m/s² = 19.6 N or more

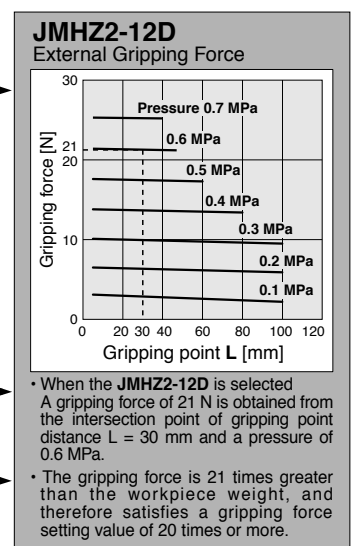

Model Selection Illustration

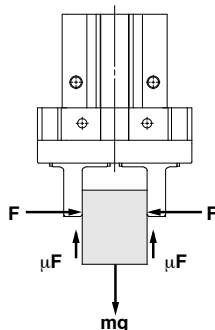

When gripping a workpiece as in the figure to the left, and with the following definitions,
F: Gripping force [N]
μ: Coefficient of friction between the attachments and the workpiece
m: Workpiece mass [kg]
g: Gravitational acceleration (= 9.8 m/s²)
mg: Workpiece weight [N]

the conditions under which the workpiece will not drop are

$$2 \times \mu F > mg$$

Number of fingers

and therefore,

$$F > \frac{mg}{2 \times \mu}$$

With "a" representing the margin, "F" is determined by the following formula:

$$F = \frac{mg}{2 \times \mu} \times a$$

"Gripping force at least 10 to 20 times greater than the workpiece weight"
 "At least 10 to 20 times greater than the workpiece weight" recommended by SMC is calculated with a margin of "a" = 4, which allows for impacts that occur during normal transportation, etc.

When $\mu = 0.2$	When $\mu = 0.1$
$F = \frac{mg}{2 \times 0.2} \times 4$ $= 10 \times mg$	$F = \frac{mg}{2 \times 0.1} \times 4$ $= 20 \times mg$

10 x Workpiece weight

20 x Workpiece weight

* Even in cases where the coefficient of friction is greater than $\mu = 0.2$, for reasons of safety, select a gripping force which is at least 10 to 20 times greater than the workpiece weight, as recommended by SMC.
 • If high acceleration, or impact forces are encountered during motion, a further margin should be considered.

Compact Type Parallel Style Air Gripper *JMHZ2 Series*

Model Selection

Step 1 Check the effective gripping force: JMHZ2 Series, Double Acting

External gripping state

- Indication of effective gripping force
The gripping force shown in the graphs to the right represents the gripping force of one finger when all fingers and attachments are in contact with the workpiece.

F = One finger thrust

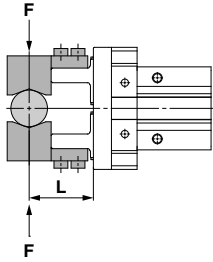

Internal gripping state

- Indication of effective gripping force
The gripping force shown in the graphs to the right represents the gripping force of one finger when all fingers and attachments are in contact with the workpiece.

F = One finger thrust

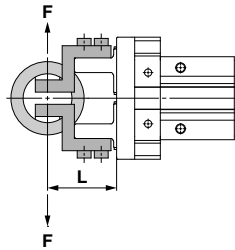

External Gripping Force

JMHZ2-8D

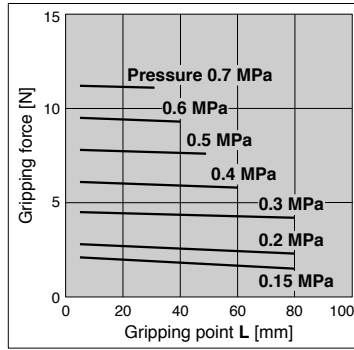

JMHZ2-12D

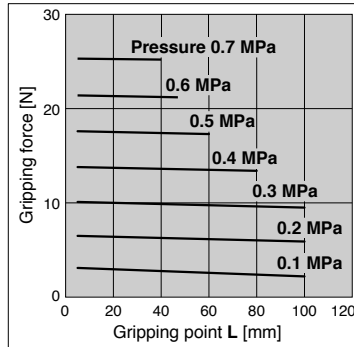

JMHZ2-16D

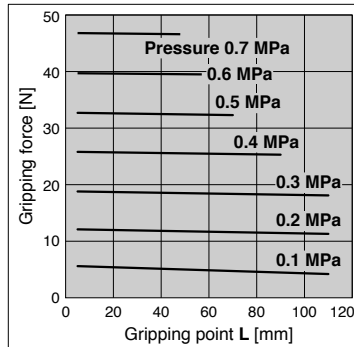

JMHZ2-20D

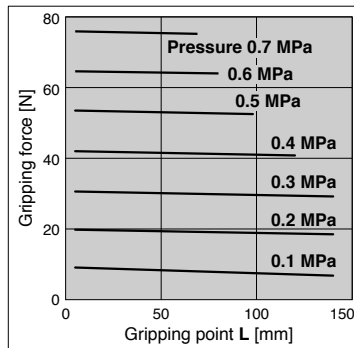

Internal Gripping Force

JMHZ2-8D

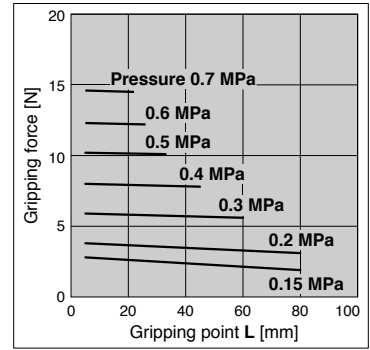

JMHZ2-12D

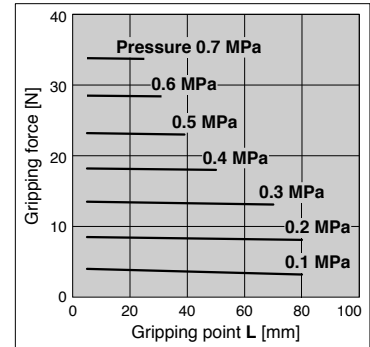

JMHZ2-16D

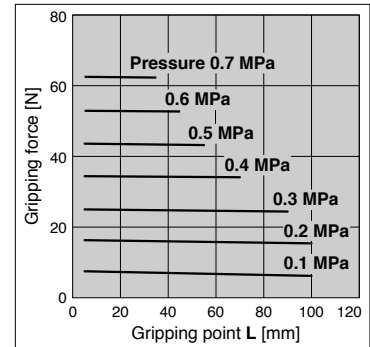

JMHZ2-20D

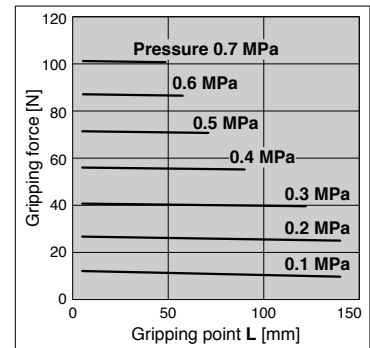

Model Selection

Step 2 Check the gripping point: JMHZ2 Series

External gripping state

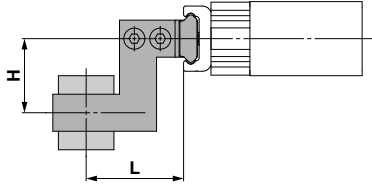

Internal gripping state

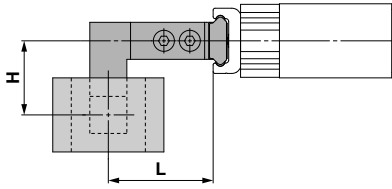

- The air gripper should be operated so that the workpiece gripping point "L" and the amount of overhang "H" stay within the range shown for each operating pressure given in the graphs to the right.
- If the workpiece gripping point goes beyond the range limits, this will have an adverse effect on the life of the air gripper.

External Grip

JMHZ2-8D

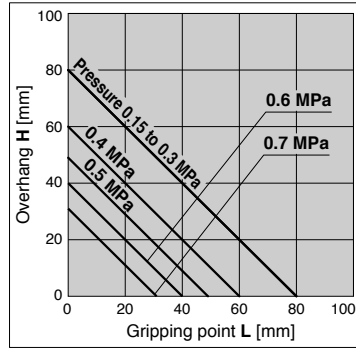

JMHZ2-12D

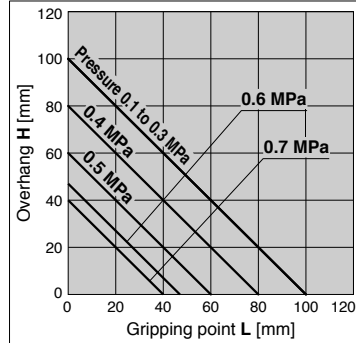

JMHZ2-16D

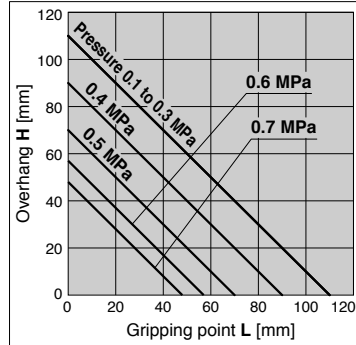

JMHZ2-20D

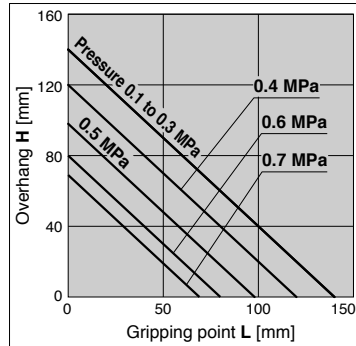

Internal Grip

JMHZ2-8D

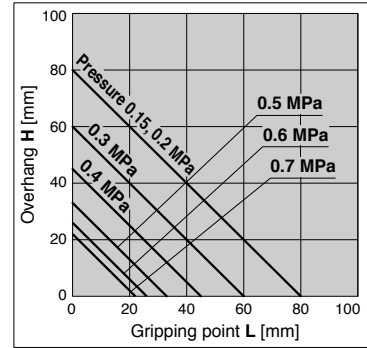

JMHZ2-12D

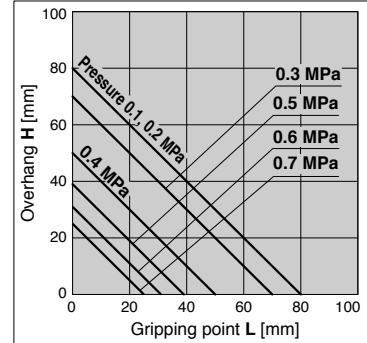

JMHZ2-16D

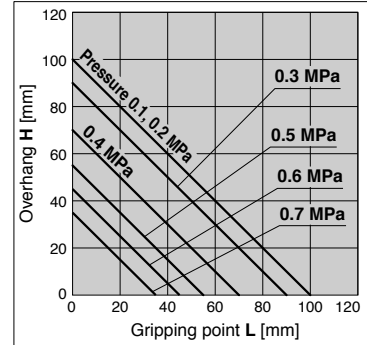

JMHZ2-20D

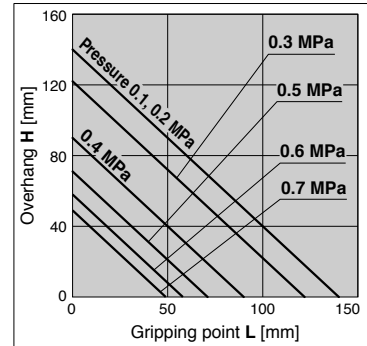

Compact Type Parallel Style Air Gripper *JMHZ2 Series*

Model Selection

Step 3 Check the external force on fingers: JMHZ2 Series

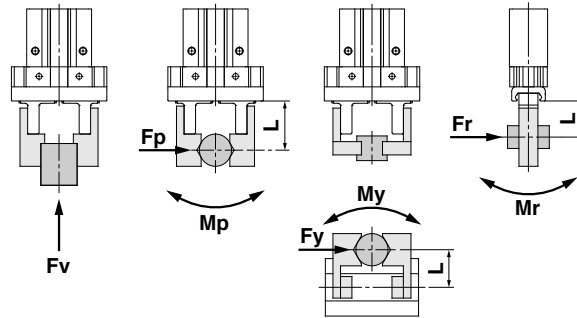

L: Distance to the point at which the load is applied [mm]

Model	Allowable vertical load*1 Fv [N]	Maximum allowable moment/load*2			Maximum load Fp, Fy, Fr [N]*3
		Pitch moment Mp [N·m]	Yaw moment My [N·m]	Roll moment Mr [N·m]	
JMHZ2-8	58		0.26		14
JMHZ2-12	98		0.68		33
JMHZ2-16	147		1.32		62
JMHZ2-20	255		1.94		100

*1 Inertial loads will be generated at the stroke end when the product is used for transportation. Consider the rate of acceleration.

*2 Ensure moments and loads are the allowable values or less.

*3 Even when the dimension L is short, the maximum load should not be exceeded.

Calculation Examples of External Force

① Workpiece insertion

When a moment in one direction is applied

When a workpiece held by JMHZ2-16D at L = 30 mm, a roll moment Mr is generated due to load Fr = 20 [N].

$$\begin{aligned} Mr &= Fr \times L \times 10^{-3*1} \quad (*1: \text{Constant for unit conversion}) \\ &= 20 \times 30 \times 10^{-3} \\ &= 0.6 \text{ [N·m]} \end{aligned}$$

The moment Mr = 0.6 [N·m] is the allowable moment of 1.32 [N·m] or less. The load F = 20 [N] is the allowable load of 62 [N] or less. The product is suitable for the workpiece.

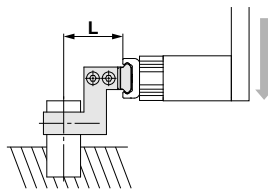

② Workpiece transfer

When moments in multiple directions are applied

Hold the workpiece using JMHZ2-16D to transport it horizontally.

Attachment mass (One side) m1: 0.05 [kg]

Workpiece mass m2: 0.3 [kg]

Acceleration load A is generated when stopping at the end of transportation: 3g (g: Gravitational acceleration = 9.8 m/s²)

Calculate the followings: Load: Mass of the attachment and workpiece x acceleration (including their own weight). Moment: Mass x distance to the center of gravity of the attachment and mass x distance to the center of gravity of the workpiece.

1. Pitch direction (Moment due to acceleration speed)

$$\begin{aligned} Fp &= (m1 \times 2 + m2) \times A \\ &= (0.05 \times 2 + 0.3) \times 3 \times 9.8 \\ &= 11.76 \text{ [N]} \end{aligned}$$

Distance to the center of gravity of the attachment La = 20 mm,
Distance to the center of gravity of the workpiece Lb = 30 mm

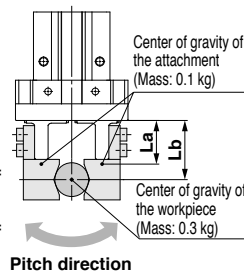

$$Mp = (m1 \times La \times 10^{-3*1} \times 2 + m2 \times Lb \times 10^{-3*1}) \times A$$

$$\begin{aligned} &= (0.05 \times 20 \times 10^{-3} \times 2 + 0.3 \times 30 \times 10^{-3}) \times 3 \times 9.8 \\ &\approx 0.32 \text{ [N·m]} \end{aligned}$$

2. Yaw direction (Moment due to acceleration speed)

Distance to the center of gravity of the attachment La = 15 mm,
Distance to the center of gravity of the workpiece Lb = 18 mm

$$\begin{aligned} Fy &= (m1 \times 2 + m2) \times A \\ &= (0.05 \times 2 + 0.3) \times 3 \times 9.8 \\ &= 11.76 \text{ [N]} \end{aligned}$$

$$\begin{aligned} My &= (m1 \times La \times 10^{-3*1} \times 2 + m2 \times Lb \times 10^{-3*1}) \times A \\ &= (0.05 \times 15 \times 10^{-3} \times 2 + 0.3 \times 18 \times 10^{-3}) \times 3 \times 9.8 \\ &\approx 0.20 \text{ [N·m]} \end{aligned}$$

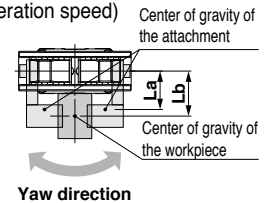

3. Roll direction (Moment due to the own weight of the attachment and workpiece)

Distance to the center of gravity of the attachment La = 20 mm,
Distance to the center of gravity of the workpiece Lb = 30 mm

$$\begin{aligned} Fr &= (m1 \times 2 + m2) \times g \\ &= (0.05 \times 2 + 0.3) \times 9.8 \\ &= 3.92 \text{ [N]} \end{aligned}$$

$$\begin{aligned} Mr &= (m1 \times La \times 10^{-3*1} \times 2 + m2 \times Lb \times 10^{-3*1}) \times g \\ &= (0.05 \times 20 \times 10^{-3} \times 2 + 0.3 \times 30 \times 10^{-3}) \times 9.8 \\ &\approx 0.11 \text{ [N·m]} \end{aligned}$$

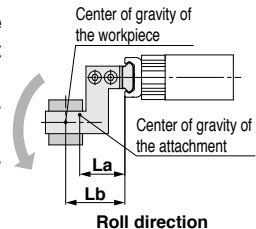

Moments: Mp + My + Mr = 0.32 + 0.20 + 0.11 = 0.63 [N·m] is the allowable moment of 1.32 [N·m] or less. Loads: Fp, Fy and Fr of each direction is the maximum allowable load of 62 [N] or less. The product is suitable for the workpiece.

Compact Type Parallel Style Air Gripper *JMHZ2 Series* ø8, ø12, ø16, ø20



How to Order

Bore Size

ø8 to ø20 **JMHZ2-16D-M9BW**

Number of fingers

2	2
---	---

Bore size

8	8 mm
12	12 mm
16	16 mm
20	20 mm

Action

D	Double acting
---	---------------

Number of auto switches

Nil	2
S	1
n	n

Auto switch

Nil	Without auto switch (Built-in magnet)
-----	---------------------------------------

* For applicable auto switches, refer to the table below.

Finger option

[Standard]
 Nil: Basic

1: Side tapped mounting

2: Through-holes in opening/closing direction

**Moisture Control Tube
 IDK Series**

When operating an actuator with a small bore size and a short stroke at a high frequency, dew condensation (water droplets) may occur inside the piping depending on the conditions. Simply connecting the moisture control tube to the actuator will prevent dew condensation from occurring. For details, refer to the IDK series in the **Web Catalog** and the Best Pneumatics Catalog.

Applicable Auto Switches/Refer to the **Web Catalog** and the Best Pneumatics Catalog for further information on auto switches.

Type	Special function	Electrical entry	Indicator light	Wiring (Output)	Load voltage		Auto switch model		Lead wire length [m]*1				Pre-wired connector	Applicable load		
					DC	AC	Perpendicular	In-line	0.5 (Nil)	1 (M)	3 (L)	5 (Z)		IC circuit	Relay, PLC	
Solid state auto switch	—	Grommet	Yes	3-wire (NPN)	24 V	5 V, 12 V	—	M9NV	M9N	●	●	●	○	○	IC circuit	Relay, PLC
				3-wire (PNP)				M9PV	M9P	●	●	●	○	○		
				2-wire	12 V	M9BV	M9B	●	●	●	○	○	—			
				3-wire (NPN)	5 V, 12 V	M9NVV	M9NW	●	●	●	○	○	IC circuit			
	3-wire (PNP)			M9PVV		M9PW	●	●	●	○	○	—				
	2-wire			12 V	M9BWV	M9BW	●	●	●	○	○	—				
				Water resistant (2-color indicator)	3-wire (NPN)	5 V, 12 V	M9NAV *2	M9NA *2	○	○	●	○	○	IC circuit		
	3-wire (PNP)				M9PAV *2		M9PA *2	○	○	●	○	○	—			
	2-wire				12 V	M9BAV *2	M9BA *2	○	○	●	○	○	—			

*1 Lead wire length symbols: 0.5 m..... Nil
 1 m..... M
 3 m..... L
 5 m..... Z

*2 Water-resistant type auto switches can be mounted on the above models, but SMC cannot guarantee water resistance.

* Auto switches marked with "○" are produced upon receipt of order.

* When using the 2-color indicator type, please make the setting so that the indicator is lit in red to ensure the detection at the proper position of the air gripper.

Compact Type Parallel Style Air Gripper *JMHZ2 Series*

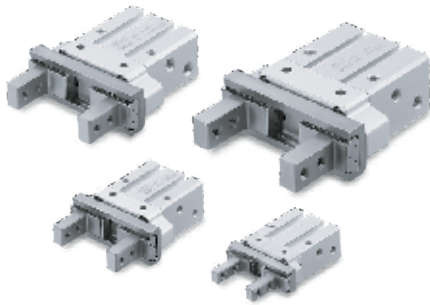

Symbol

Double acting,
Internal grip

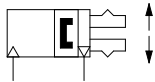

Double acting,
External grip

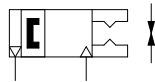

Refer to pages 15 to 17 for cylinders with auto switches.

- Auto Switch Installation Examples and Mounting Positions
- Auto Switch Hysteresis
- Auto Switch Mounting
- Protrusion of Auto Switch from Edge of Body

Precautions

Be sure to read this before handling the products. Refer to pages 19 and 20 for details.

Specifications

Bore size [mm]	8	12	16	20
Fluid	Air			
Operating pressure	ø8: 0.15 to 0.7 MPa ø12 to ø20: 0.1 to 0.7 MPa			
Ambient and fluid temperatures	-10 to 60°C (No freezing)			
Repeatability	±0.01 mm			
Max. operating frequency	120 c.p.m.			
Lubricant	Non-lube			
Action	Double acting			
Auto switch (Option)*1	Solid state auto switch (3-wire, 2-wire)			

*1 Refer to pages 15 to 17 for details on auto switches.

Model

Model	Bore size [mm]	Action	Gripping force*1		Opening/ Closing stroke (Both sides) [mm]	Weight*2 [g]	Volume [cm ³]	
			Effective gripping force per finger [N]				Finger opening port	Finger closing port
			External	Internal				
JMHZ2-8D	8	Double acting	7.8	10.5	4	31	0.3	0.2
JMHZ2-12D	12		17.5	23.3	6	65	0.6	0.4
JMHZ2-16D	16		32.7	43.5	10	128	1.6	1.1
JMHZ2-20D	20		54.2	72.2	14	240	3.3	2.2

*1 At the pressure of 0.5 MPa, when gripping point L is 20 mm

*2 Excluding the auto switch weight

Compact Type Parallel Style Air Gripper *JMHZ2 Series*

Construction: JMHZ2-8D to 20D

With fingers open

With fingers closed

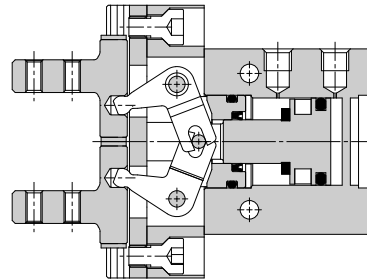
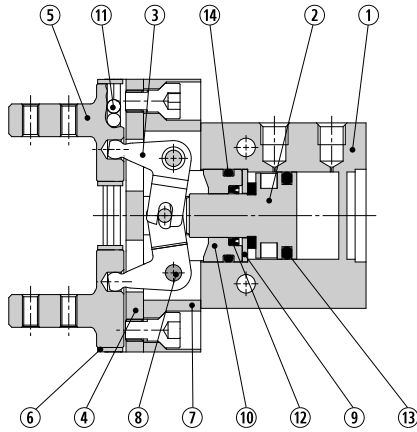

Component Parts

No.	Description	No.	Description
1	Body A	10	Rod cover
2	Piston assembly	11	Steel ball
3	Lever	12	Rod seal
4	Guide	13	Piston seal
5	Finger	14	Gasket
6	Roller stopper		
7	Body B		
8	Lever shaft		
9	Seal support		

Replacement Parts

Description	JMHZ2-8	JMHZ2-12	JMHZ2-16	JMHZ2-20	Contents	
Seal kit	JMHZ2-□D	JMHZ8-PS	JMHZ12-PS	JMHZ16-PS	JMHZ20-PS	⑩⑬⑭
Finger assembly	JMHZ2-□□	JMHZ-A0802	JMHZ-A1202	JMHZ-A1602	JMHZ-A2002	④⑤⑥⑪ Mounting screw
	JMHZ2-□□1	JMHZ-A0802-1	JMHZ-A1202-1	JMHZ-A1602-1	JMHZ-A2002-1	
	JMHZ2-□□2	JMHZ-A0802-2	JMHZ-A1202-2	JMHZ-A1602-2	JMHZ-A2002-2	
Piston assembly	JMHZ2-□D	JMHZ-A0803	JMHZ-A1203	JMHZ-A1603	JMHZ-A2003	②
Lever assembly		JMHZ-A0804	JMHZ-A1204	JMHZ-A1604	JMHZ-A2004	③

* Finger option

1 = Side tapped, 2 = Through-hole

* The seal kit does not include a grease pack. Order it separately. Grease pack part number: GR-S-010 (10 g)

Compact Type Parallel Style Air Gripper *JMHZ2 Series*

Dimensions

JMHZ2-8D

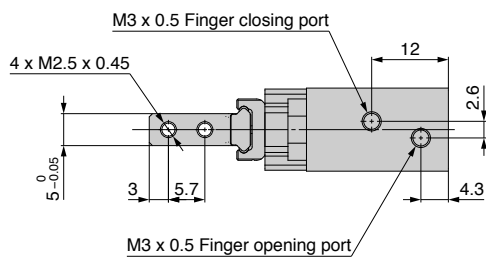
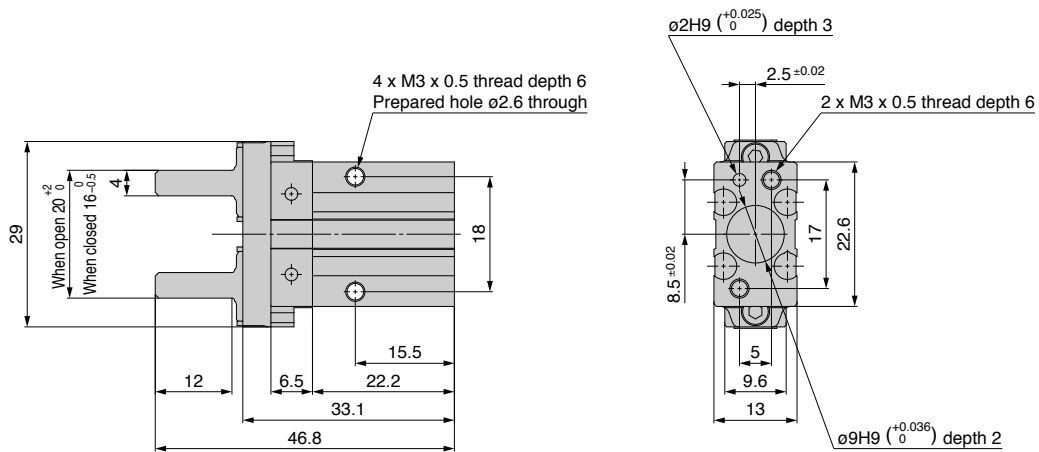

Dimensions of auto switch mounting groove

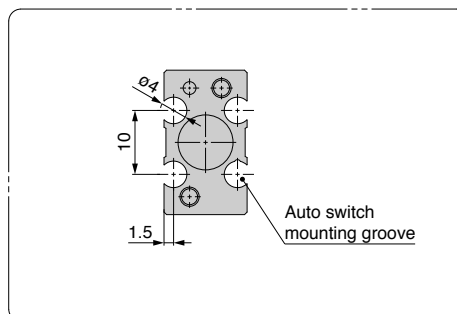

Compact Type Parallel Style Air Gripper *JMHZ2 Series*

Dimensions

JMHZ2-12D

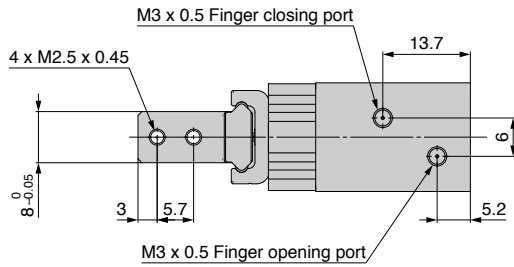
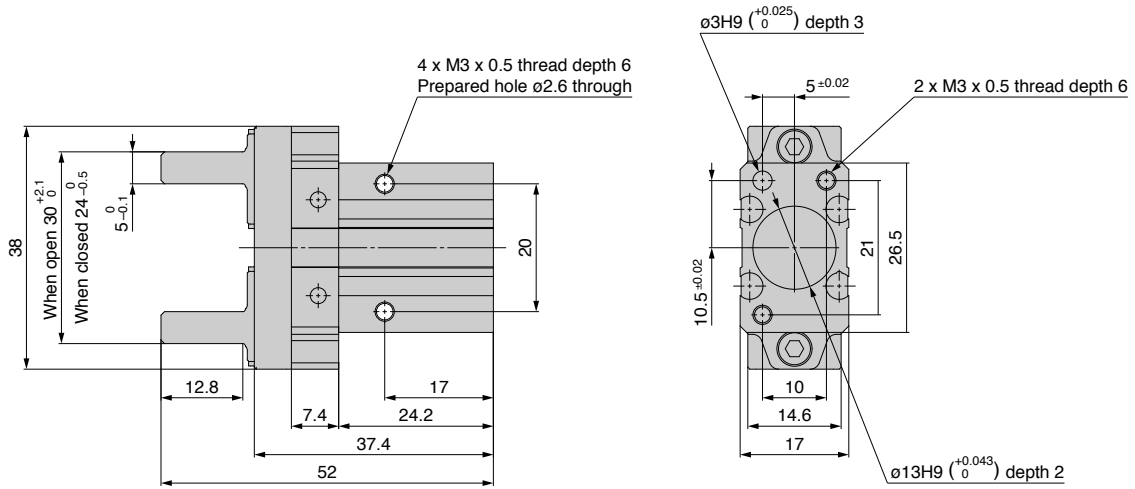

Dimensions of auto switch mounting groove

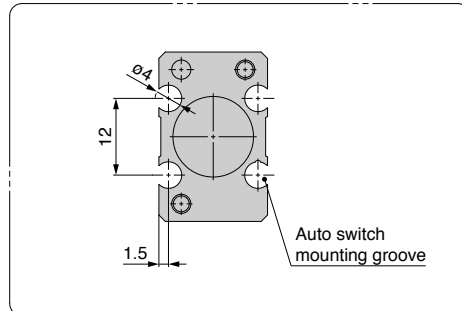

Compact Type Parallel Style Air Gripper *JMHZ2 Series*

Dimensions

JMHZ2-16D

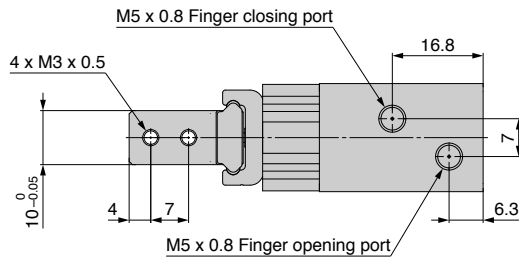
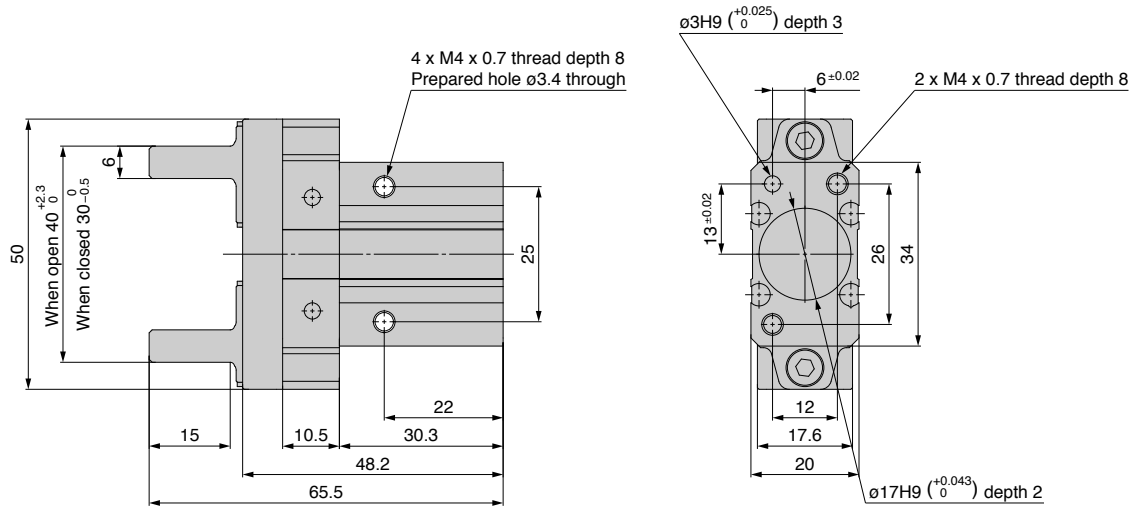

Dimensions of auto switch mounting groove

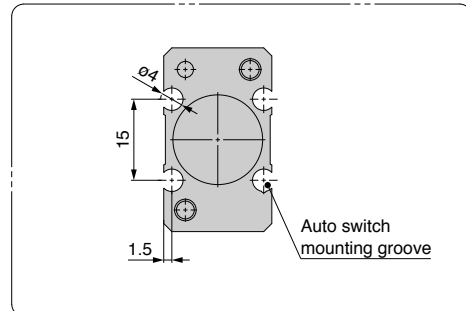

Compact Type Parallel Style Air Gripper *JMHZ2 Series*

Dimensions

JMHZ2-20D

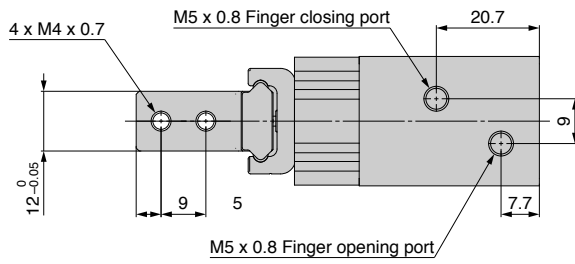
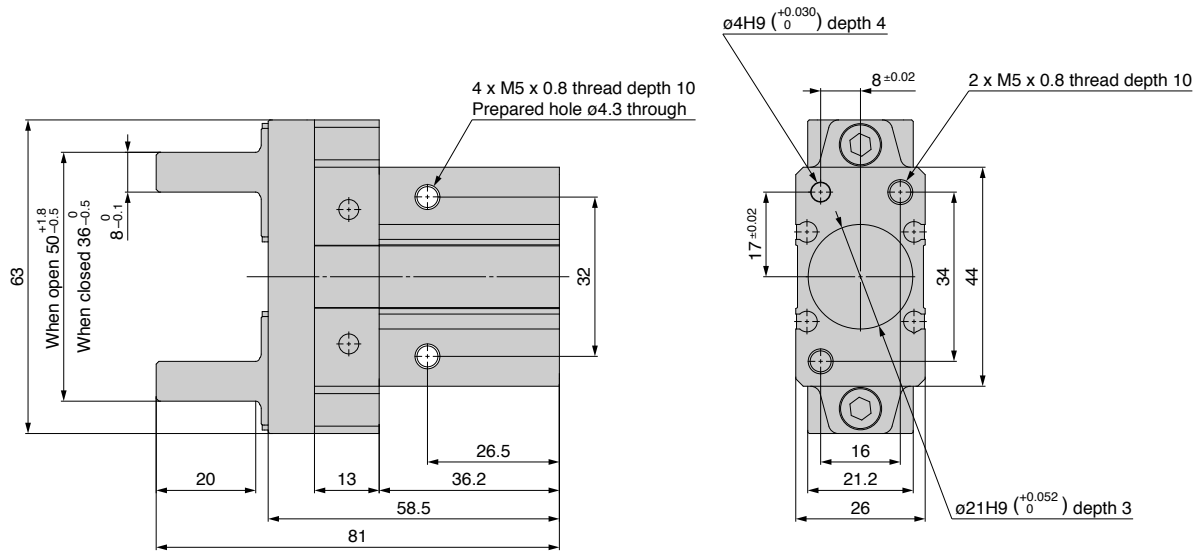

Dimensions of auto switch mounting groove

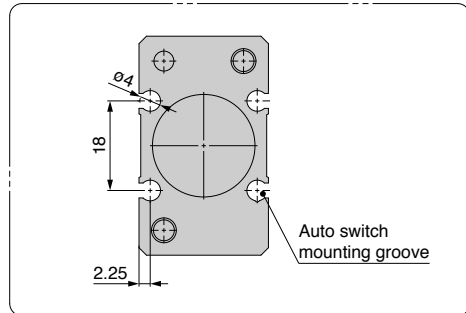

JMHZ2 Series

Auto Switch Installation Examples and Mounting Positions

Various auto switch applications are possible through different combinations of auto switch quantities and detecting positions.

1) Detection when Gripping Exterior of a Workpiece

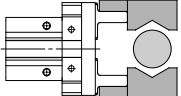
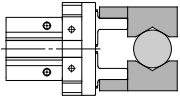
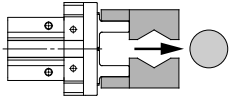
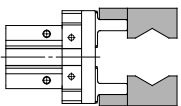
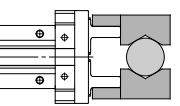
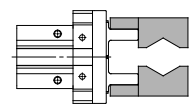
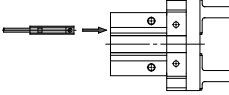
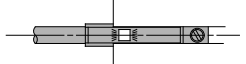
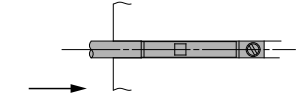
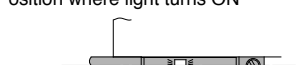
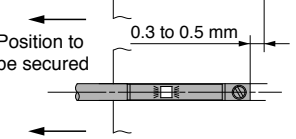
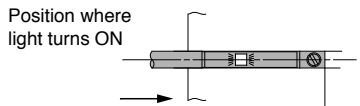
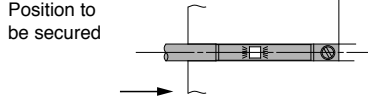
Detection example		① Confirmation of fingers in reset position	② Confirmation of a workpiece held	③ Confirmation of a workpiece released
Position to be detected		Position of fingers fully open 	Position when gripping a workpiece 	Position of fingers fully closed 
Operation of auto switches		When fingers return: Auto switch to turn ON (Light ON)	When gripping a workpiece: Auto switch to turn ON (Light ON)	When a workpiece is not held (Abnormal operation): Auto switch to turn ON (Light ON)
Detection combinations	One auto switch * One position, any of ①, ② and ③ can be detected.	●	●	●
	Two auto switches * Two positions of ①, ② and ③ can be detected.	●	●	—
		—	●	●
Pattern	A	●	—	●
	B	—	●	●
	C	●	—	●
How to determine auto switch installation position		Step 1) Fully open the fingers. 	Step 1) Position fingers for gripping a workpiece. 	Step 1) Fully close the fingers. 
At no pressure or low pressure, connect the auto switch to a power supply, and follow the directions.		Step 2) Insert the auto switch into the auto switch mounting groove in the direction as shown in the illustration below. 		
		<p>Step 3) Slide the auto switch in the direction of the arrow until the indicator light illuminates.</p>  <p>Step 4) Slide the auto switch further in the direction of the arrow until the indicator light goes out.</p>  <p>Step 5) Slide the auto switch in the opposite direction and fasten it at a position 0.3 to 0.5 mm beyond the position where the indicator light illuminates.</p> <p>Position where light turns ON</p>  <p>Position to be secured</p> 	<p>Step 3) Slide the auto switch in the direction of the arrow until the indicator light illuminates and fasten it at a position 0.3 to 0.5 mm in the direction of the arrow beyond the position where the indicator light illuminates.</p> <p>Position where light turns ON</p>  <p>0.3 to 0.5 mm</p> <p>Position to be secured</p> 	

- * It is recommended that gripping of a workpiece be performed close to the center of the finger stroke.
- * When holding a workpiece close at the end of opening/closing stroke of fingers, detecting performance of the combinations listed in the table above may be limited, depending on the hysteresis of an auto switch, etc.

JMHZ2 Series

Auto Switch Installation Examples and Mounting Positions

Various auto switch applications are possible through different combinations of auto switch quantities and detecting positions.

2) Detection when Gripping Interior of a Workpiece

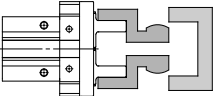
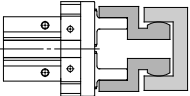
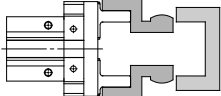
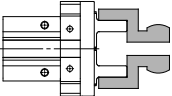
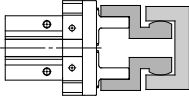
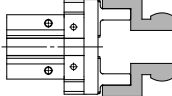
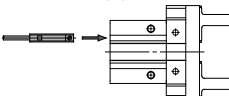
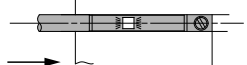
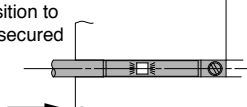
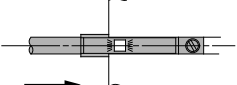
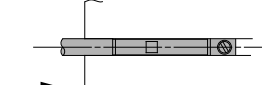
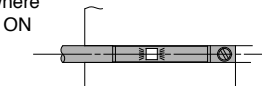
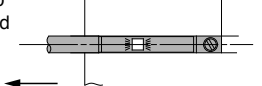
Detection example		① Confirmation of fingers in reset position	② Confirmation of a workpiece held	③ Confirmation of a workpiece released
Position to be detected		Position of fingers fully closed 	Position when gripping a workpiece 	Position of fingers fully open 
Operation of auto switches		When fingers return: Auto switch to turn ON (Light ON)	When gripping a workpiece: Auto switch to turn ON (Light ON)	When a workpiece is not held (Abnormal operation): Auto switch to turn ON (Light ON)
Detection combinations	One auto switch * One position, any of ①, ② and ③ can be detected.	●	●	●
	Two auto switches * Two positions of ①, ② and ③ can be detected.	●	●	—
		—	●	●
Pattern	A	●	—	—
	B	—	●	●
	C	●	—	●
How to determine auto switch installation position		Step 1) Fully close the fingers. 	Step 1) Position fingers for gripping a workpiece. 	Step 1) Fully open the fingers. 
At no pressure or low pressure, connect the auto switch to a power supply, and follow the directions.		Step 2) Insert the auto switch into the auto switch mounting groove in the direction as shown in the illustration below. 		
		Step 3) Slide the auto switch in the direction of the arrow until the indicator light illuminates and fasten it at a position 0.3 to 0.5 mm in the direction of the arrow beyond the position where the indicator light illuminates. Position where light turns ON  Position to be secured  0.3 to 0.5 mm	Step 3) Slide the auto switch in the direction of the arrow until the indicator light illuminates. 	Step 4) Slide the auto switch further in the direction of the arrow until the indicator light goes out. 
			Step 5) Slide the auto switch in the opposite direction and fasten it at a position 0.3 to 0.5 mm beyond the position where the indicator light illuminates. Position where light turns ON  Position to be secured  0.3 to 0.5 mm	

* It is recommended that gripping of a workpiece be performed close to the center of the finger stroke.
 * When holding a workpiece close at the end of opening/closing stroke of fingers, detecting performance of the combinations listed in the table above may be limited, depending on the hysteresis of an auto switch, etc.

Compact Type Parallel Style Air Gripper *JMHZ2 Series*

Auto Switch Hysteresis

Auto switches have hysteresis similar to micro switches. Use the table below as a guide when adjusting auto switch positions, etc.

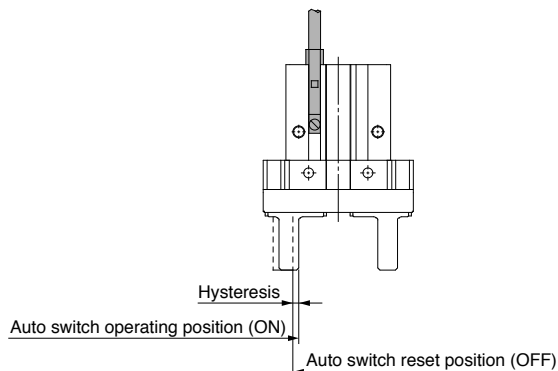

Hysteresis

Model	Auto switch model	0.7 0.6 0.7 0.6
	D-M9□(V) D-M9□W(V) D-M9□A(V)	
JMHZ2-8		0.7
JMHZ2-12		0.6
JMHZ2-16		0.7
JMHZ2-20		0.6

Auto Switch Mounting

To set the auto switch, insert the auto switch into the auto switch installation groove of the gripper from the direction as shown in the illustration below. After setting the position, tighten the attached auto switch mounting screw with a flat blade watchmaker's screwdriver.

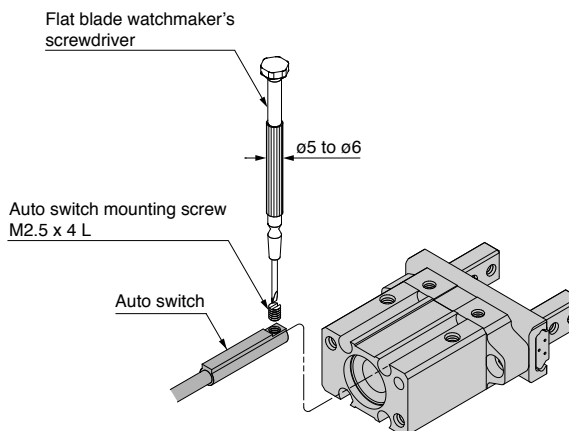

* Use a watchmaker's screwdriver with a grip diameter of 5 to 6 mm to tighten the auto switch mounting screw. The tightening torque should be 0.05 to 0.15 N·m.

Protrusion of Auto Switch from Edge of Body

The amount of auto switch protrusion from the body end surface is shown in the table below. Use this as a standard when mounting, etc.

Protrusion of Auto Switch

Model	Lead wire type	In-line entry		Perpendicular entry	
		D-M9□ D-M9□W	D-M9□A	D-M9□V D-M9□WV	D-M9□AV
JMHZ2-8D	Open	5	7	3	5
	Closed	7.5	9.5	5.5	7.5
JMHZ2-12D	Open	3.5	5.5	1.5	3.5
	Closed	7.5	9.5	5.5	7.5
JMHZ2-16D	Open	—	2.0	—	—
	Closed	5.5	7.5	3.5	5.5
JMHZ2-20D	Open	—	—	—	—
	Closed	4	6	2	4

* There is no protrusion for sections of the table with no values entered.

Prior to Use

Auto Switch Connections and Examples

Sink Input Specifications

3-wire, NPN

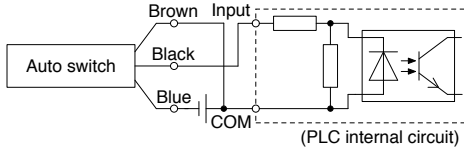

2-wire

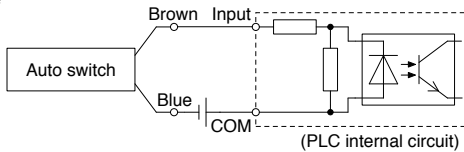

Source Input Specifications

3-wire, PNP

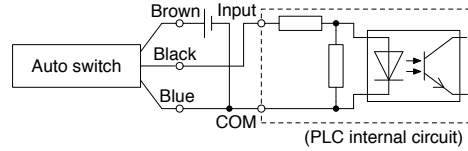

2-wire

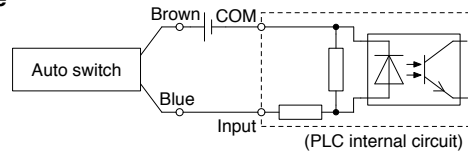

Connect according to the applicable PLC input specifications, as the connection method will vary depending on the PLC input specifications.

Examples of AND (Series) and OR (Parallel) Connections

* When using solid state auto switches, ensure the application is set up so the signals for the first 50 ms are invalid. Depending on the operating environment, the product may not operate properly.

3-wire AND connection for NPN output

(Using relays)

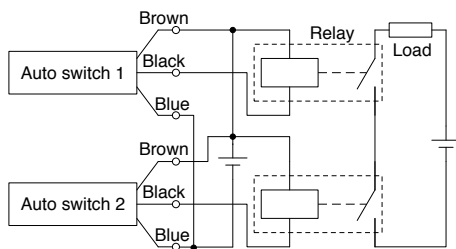

(Performed with auto switches only)

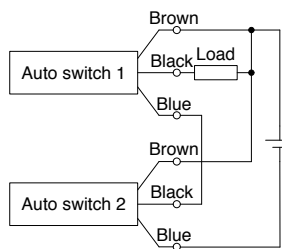

3-wire OR connection for NPN output

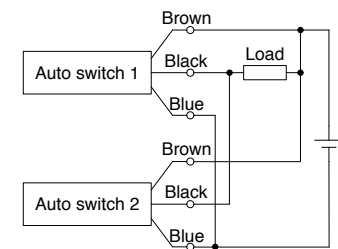

3-wire AND connection for PNP output

(Using relays)

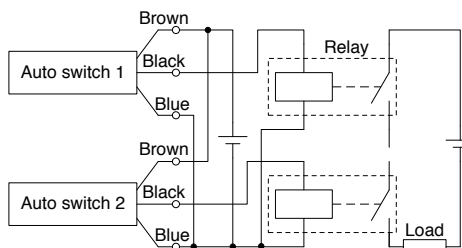

(Performed with auto switches only)

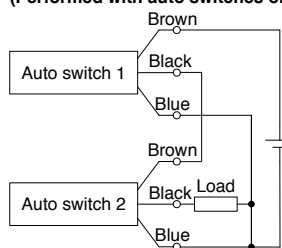

3-wire OR connection for PNP output

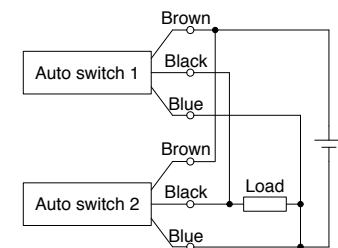

2-wire AND connection

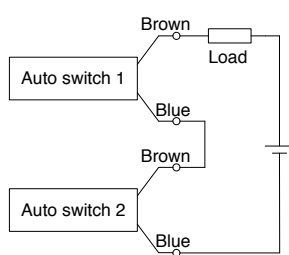

When two auto switches are connected in series, a load may malfunction because the load voltage will decline when in the ON state. The indicator lights will light up when both of the auto switches are in the ON state. Auto switches with a load voltage less than 20 V cannot be used.

$$\begin{aligned} \text{Load voltage at ON} &= \text{Power supply voltage} - \\ &\quad \text{Residual voltage} \times 2 \text{ pcs.} \\ &= 24 \text{ V} - 4 \text{ V} \times 2 \text{ pcs.} \\ &= 16 \text{ V} \end{aligned}$$

Example: Power supply is 24 VDC
Internal voltage drop in auto switch is 4 V.

2-wire OR connection

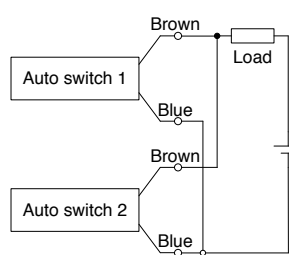

(Solid state)
When two auto switches are connected in parallel, malfunction may occur because the load voltage will increase when in the OFF state.

(Reed)
Because there is no current leakage, the load voltage will not increase when turned OFF. However, depending on the number of auto switches in the ON state, the indicator lights may sometimes grow dim or not light up, due to the dispersion and reduction of the current flowing to the auto switches.

$$\begin{aligned} \text{Load voltage at OFF} &= \text{Leakage current} \times 2 \text{ pcs.} \times \\ &\quad \text{Load impedance} \\ &= 1 \text{ mA} \times 2 \text{ pcs.} \times 3 \text{ k}\Omega \\ &= 6 \text{ V} \end{aligned}$$

Example: Load impedance is 3 k Ω .
Leakage current from auto switch is 1 mA.



JMHZ2 Series Specific Product Precautions 1

Be sure to read this before handling the products. Refer to the back cover for safety instructions. For temperature control equipment precautions, refer to the “Handling Precautions for SMC Products” and the “Operation Manual” on SMC website.

Operating Environment

⚠ Caution

Use caution for the anti-corrosiveness of the linear guide unit.

Martensitic stainless steel is used for the finger guide. However, the anti-corrosiveness of this steel is inferior to that of austenitic stainless steel. In particular, rust may be generated in environments where waterdrops are likely to adhere due to condensation, etc.

Handling

⚠ Caution

Finite orbit type guide is used in the actuator finger part. By using this, when there are inertial force which cause by movements or rotation to the actuator, steel ball will move to one side and this will cause a large resistance and degrade the accuracy. When there are inertial force which cause by movements or rotation to the actuator, operate the finger to full stroke.

How to Mount Air Grippers

Possible to mount from 2 directions

How to mount air grippers

Axial mounting (Body tapped)

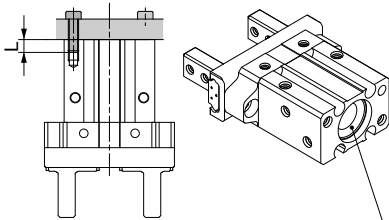

Use the hole at the end of the body for positioning, etc.

Model	Applicable bolt	Max. tightening torque [N·m]	Max. screw-in depth L [mm]
JMHZ2-8	M3 x 0.5	0.88	6
JMHZ2-12	M3 x 0.5	0.88	6
JMHZ2-16	M4 x 0.7	2.1	8
JMHZ2-20	M5 x 0.8	4.3	10

Model	Hole diameter	Hole depth [mm]
JMHZ2-8	ø9H9 ^{+0.036} ₀	2
JMHZ2-12	ø13H9 ^{+0.043} ₀	2
JMHZ2-16	ø17H9 ^{+0.043} ₀	2
JMHZ2-20	ø21H9 ^{+0.052} ₀	3

How to mount air grippers

Lateral mounting (Body tapped and through-holes)

● Body tapped

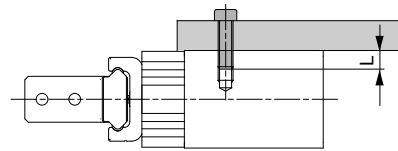

Model	Applicable bolt	Max. tightening torque [N·m]	Max. screw-in depth L [mm]
JMHZ2-8	M3 x 0.5	0.88	6
JMHZ2-12	M3 x 0.5	0.88	6
JMHZ2-16	M4 x 0.7	2.1	8
JMHZ2-20	M5 x 0.8	4.3	10

● Body through-holes

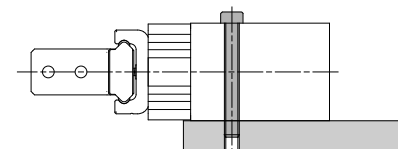

Model	Applicable bolt	Max. tightening torque [N·m]
JMHZ2-8	M2.5 x 0.45	0.31
JMHZ2-12	M2.5 x 0.45	0.31
JMHZ2-16	M3 x 0.5	0.59
JMHZ2-20	M4 x 0.7	1.4

How to mount attachments to the finger

The attachment must be mounted on fingers using bolts such as finger mounting female threads, etc., which should be tightened with the tightening torque in the table below.

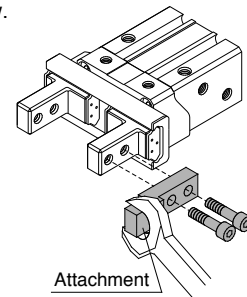

Model	Applicable bolt	Max. tightening torque [N·m]
JMHZ2-8	M2.5 x 0.45	0.31
JMHZ2-12	M2.5 x 0.45	0.31
JMHZ2-16	M3 x 0.5	0.59
JMHZ2-20	M4 x 0.7	1.4

Considerations for attachment mass

A long or heavy attachment increases the inertia force required to open or close the fingers. This may cause unsteady movement of fingers and decrease the life of the gripper. Design the attachment as short and light as possible referring to the mass specified in the table below.

Model	Attachment mass (One side) [g]
JMHZ2-8	18
JMHZ2-12	35
JMHZ2-16	70
JMHZ2-20	140



JMHZ2 Series Specific Product Precautions 2

Be sure to read this before handling the products. Refer to the back cover for safety instructions. For temperature control equipment precautions, refer to the "Handling Precautions for SMC Products" and the "Operation Manual" on SMC website.

Precautions when Using Elbow Fittings

When elbow piping fittings are used, they may interfere with each other or part of gripper, limiting the range for piping entry. Please use extended male elbow, KQ2W, or extension fittings listed in the table below to avoid this situation.

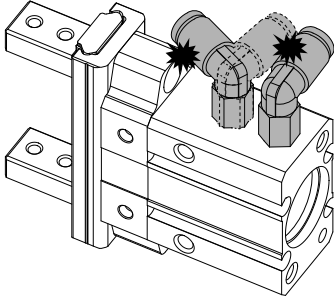

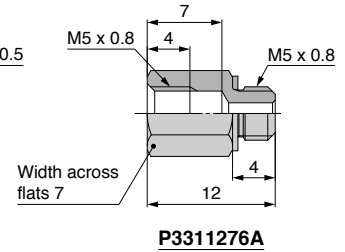
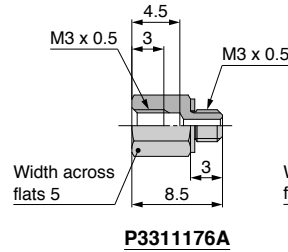

Model	Extension fitting
JMHZ2-8	P3311176A
JMHZ2-12	P3311276A
JMHZ2-16	P3311276A
JMHZ2-20	P3311276A



Safety Instructions

These safety instructions are intended to prevent hazardous situations and/or equipment damage. These instructions indicate the level of potential hazard with the labels of “**Caution**,” “**Warning**” or “**Danger**.” They are all important notes for safety and must be followed in addition to International Standards (ISO/IEC)*1), and other safety regulations.

 **Caution:** **Caution** indicates a hazard with a low level of risk which, if not avoided, could result in minor or moderate injury.

 **Warning:** **Warning** indicates a hazard with a medium level of risk which, if not avoided, could result in death or serious injury.

 **Danger:** **Danger** indicates a hazard with a high level of risk which, if not avoided, will result in death or serious injury.

*1) ISO 4414: Pneumatic fluid power – General rules relating to systems.
 ISO 4413: Hydraulic fluid power – General rules relating to systems.
 IEC 60204-1: Safety of machinery – Electrical equipment of machines.
 (Part 1: General requirements)
 ISO 10218-1: Manipulating industrial robots – Safety.
 etc.

Warning

1. The compatibility of the product is the responsibility of the person who designs the equipment or decides its specifications.

Since the product specified here is used under various operating conditions, its compatibility with specific equipment must be decided by the person who designs the equipment or decides its specifications based on necessary analysis and test results. The expected performance and safety assurance of the equipment will be the responsibility of the person who has determined its compatibility with the product. This person should also continuously review all specifications of the product referring to its latest catalog information, with a view to giving due consideration to any possibility of equipment failure when configuring the equipment.

2. Only personnel with appropriate training should operate machinery and equipment.

The product specified here may become unsafe if handled incorrectly. The assembly, operation and maintenance of machines or equipment including our products must be performed by an operator who is appropriately trained and experienced.

3. Do not service or attempt to remove product and machinery/equipment until safety is confirmed.

1. The inspection and maintenance of machinery/equipment should only be performed after measures to prevent falling or runaway of the driven objects have been confirmed.
2. When the product is to be removed, confirm that the safety measures as mentioned above are implemented and the power from any appropriate source is cut, and read and understand the specific product precautions of all relevant products carefully.
3. Before machinery/equipment is restarted, take measures to prevent unexpected operation and malfunction.

4. Contact SMC beforehand and take special consideration of safety measures if the product is to be used in any of the following conditions.

1. Conditions and environments outside of the given specifications, or use outdoors or in a place exposed to direct sunlight.
2. Installation on equipment in conjunction with atomic energy, railways, air navigation, space, shipping, vehicles, military, medical treatment, combustion and recreation, or equipment in contact with food and beverages, emergency stop circuits, clutch and brake circuits in press applications, safety equipment or other applications unsuitable for the standard specifications described in the product catalog.
3. An application which could have negative effects on people, property, or animals requiring special safety analysis.
4. Use in an interlock circuit, which requires the provision of double interlock for possible failure by using a mechanical protective function, and periodical checks to confirm proper operation.

Caution

1. The product is provided for use in manufacturing industries.

The product herein described is basically provided for peaceful use in manufacturing industries.
 If considering using the product in other industries, consult SMC beforehand and exchange specifications or a contract if necessary.
 If anything is unclear, contact your nearest sales branch.

Limited warranty and Disclaimer/ Compliance Requirements

The product used is subject to the following “Limited warranty and Disclaimer” and “Compliance Requirements”.

Read and accept them before using the product.

Limited warranty and Disclaimer

1. The warranty period of the product is 1 year in service or 1.5 years after the product is delivered, whichever is first.*2)
 Also, the product may have specified durability, running distance or replacement parts. Please consult your nearest sales branch.
2. For any failure or damage reported within the warranty period which is clearly our responsibility, a replacement product or necessary parts will be provided.
 This limited warranty applies only to our product independently, and not to any other damage incurred due to the failure of the product.
3. Prior to using SMC products, please read and understand the warranty terms and disclaimers noted in the specified catalog for the particular products.

***2) Vacuum pads are excluded from this 1 year warranty.**

A vacuum pad is a consumable part, so it is warranted for a year after it is delivered.
 Also, even within the warranty period, the wear of a product due to the use of the vacuum pad or failure due to the deterioration of rubber material are not covered by the limited warranty.

Compliance Requirements

1. The use of SMC products with production equipment for the manufacture of weapons of mass destruction (WMD) or any other weapon is strictly prohibited.
2. The exports of SMC products or technology from one country to another are governed by the relevant security laws and regulations of the countries involved in the transaction. Prior to the shipment of a SMC product to another country, assure that all local rules governing that export are known and followed.

Caution

SMC products are not intended for use as instruments for legal metrology.

Measurement instruments that SMC manufactures or sells have not been qualified by type approval tests relevant to the metrology (measurement) laws of each country. Therefore, SMC products cannot be used for business or certification ordained by the metrology (measurement) laws of each country.

 **Safety Instructions** Be sure to read the “Handling Precautions for SMC Products” (M-E03-3) and “Operation Manual” before use.

UNIT CONVERSIONS

	unit	conversion	result		unit	conversion	result
length	m	x 3.28	psi	pressure	MPa	x 145	psi
	mm	x 0.04	psi		kPa	÷ 6.895	psi
mass	g	x 0.04	°F	temperature	°C	x1.8 then add 32	°F
volume	cm ³	÷ 16.387	ft-lb	torque	N·m	x 0.738	ft-lb
	L	x 61.024	lb	force	N	÷ 4.448	lb
speed	mm/s	÷ 25.4	cfm	flow	L/min	÷ 28.317	cfm

Global Manufacturing, Distribution and Service Network

Worldwide Subsidiaries

EUROPE

AUSTRIA
SMC Pneumatik GmbH (Austria)

BELGIUM
SMC Pneumatics N.V./S.A.

BULGARIA
SMC Industrial Automation Bulgaria EOOD

CROATIA
SMC Industrijska Automatika d.o.o.

CZECH REPUBLIC
SMC Industrial Automation CZ s.r.o.

DENMARK
SMC Pneumatik A/S

ESTONIA
SMC Pneumatics Estonia

FINLAND
SMC Pneumatics Finland OY

FRANCE
SMC Pneumatique S.A.

GERMANY
SMC Pneumatik GmbH

GREECE
SMC Hellas EPE

HUNGARY
SMC Hungary Ipari Automatizálási Kft.

IRELAND
SMC Pneumatics (Ireland) Ltd.

ITALY
SMC Italia S.p.A.

KAZAKHSTAN
LLP "SMC Kazakhstan"

LATVIA
SMC Pneumatics Latvia SIA

LITHUANIA
UAB "SMC Pneumatics"

NETHERLANDS
SMC Pneumatics B.V.

NORWAY
SMC Pneumatics Norway AS

POLAND
SMC Industrial Automation Polska Sp. z o.o.

ROMANIA
SMC Romania S.r.l.

RUSSIA
SMC Pneumatik LLC.

SLOVAKIA
SMC Priemyselná Automatizácia, Spol s.r.o.

SLOVENIA
SMC Industrijska Avtomatika d.o.o.

SPAIN / PORTUGAL
SMC España, S.A.

SWEDEN
SMC Pneumatics Sweden AB

SWITZERLAND
SMC Pneumatik AG

TURKEY
SMC Pnömatik Sanayi Ticaret ve Servis A.Ş.

UK
SMC Pneumatics (U.K.) Ltd.

ASIA / OCEANIA

AUSTRALIA
SMC Pneumatics (Australia) Pty. Ltd.

CHINA
SMC (China) Co., Ltd.
SMC Pneumatics (Guangzhou) Ltd.

HONG KONG
SMC Pneumatics (Hong kong) Ltd.

INDIA
SMC Pneumatics (India) Pvt. Ltd.

INDONESIA
PT. SMC Pneumatics Indonesia

JAPAN
SMC Corporation

MALAYSIA
SMC Pneumatics (S.E.A.) Sdn. Bhd.

NEW ZEALAND
SMC Pneumatics (N.Z.) Ltd.

PHILIPPINES
Shoketsu SMC Corporation

SINGAPORE
SMC Pneumatics (S.E.A.) Pte. Ltd.

SOUTH KOREA
SMC Pneumatics Korea Co., Ltd.

TAIWAN
SMC Pneumatics (Taiwan) Co., Ltd.

THAILAND
SMC (Thailand) Ltd.

UNITED ARAB EMIRATES
SMC Pneumatics Middle East FZE

VIETNAM
SMC Pneumatics (VN) Co., Ltd

AFRICA

SOUTH AFRICA
SMC Pneumatics (South Africa) Pty Ltd

NORTH, CENTRAL & SOUTH AMERICA

ARGENTINA
SMC Argentina S.A.

BOLIVIA
SMC Pneumatics Bolivia S.R.L.

BRAZIL
SMC Pneumáticos do Brasil Ltda.

CANADA
SMC Pneumatics (Canada) Ltd.

CHILE
SMC Pneumatics (Chile) S.A.

COLOMBIA
SMC Colombia Sucursal de SMC Chile, S.A.

MEXICO
SMC Corporation (Mexico) S.A. de C.V.

PERU
SMC Corporation Peru S.A.C.

USA
SMC Corporation of America

VENEZUELA
SMC Neumatica Venezuela S.A.

U.S. & Canadian Sales Offices

WEST

Austin
Dallas
Los Angeles
Phoenix
Portland
San Jose

CENTRAL

Chicago
Cincinnati
Cleveland
Detroit
Des Moines
Grand Rapids
Indianapolis
Kansas City
Milwaukee
Minneapolis
St. Louis

EAST

Albany
Atlanta
Birmingham
Boston
Charlotte
Knoxville
Nashville
New Jersey
Rochester
Tampa

CANADA

Vancouver
Toronto
Windsor
Montreal

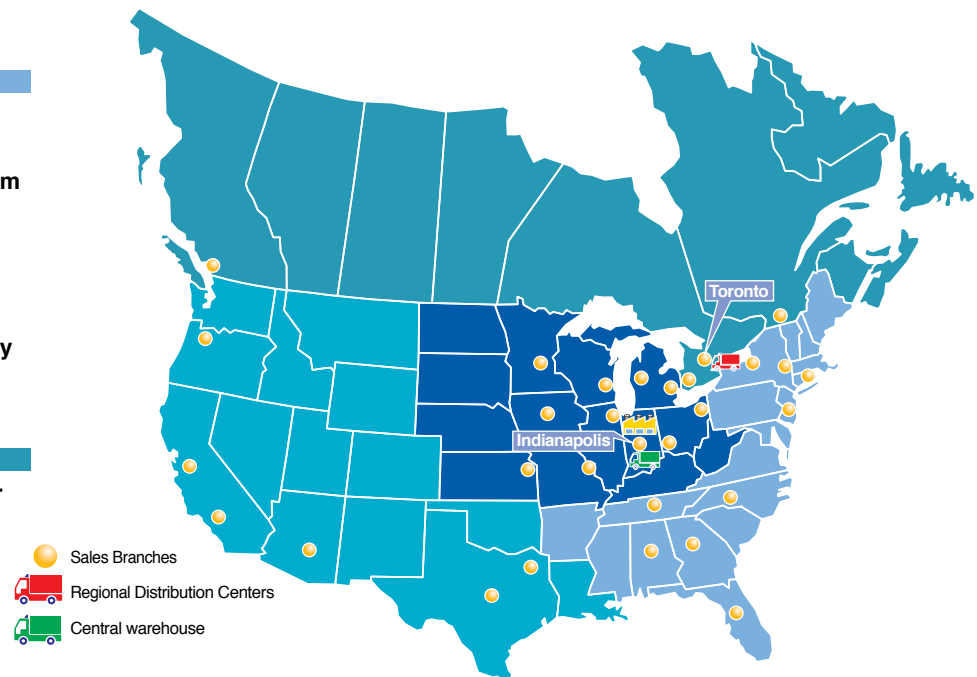

● Sales Branches
 Regional Distribution Centers
 Central warehouse

