



# Circulating Fluid Temperature Controller

## Thermo-chiller

Environmentally Resistant Type

Protection of the electrical unit:

**IP54**

**Resistant to dust and water splashing**



**The cooling capacity 5000 W (60 Hz) type has been newly added.**

### Metal panel

- The entire exterior surface is metal.
- A stainless steel panel can be selected. (Option)

### Large capacity tank (3.17 gal)

- Increased circulating fluid recovery volume (Option)

Temperature stability:  $\pm 32.018^{\circ}\text{F}$

Ambient temperature: 41 to 113°F

With heating function

Environmentally friendly **R410A** as refrigerant

Model	Cooling capacity (60 Hz)	Temperature stability	Set temperature range	Size [inches]
HRS018-R	1900 W	$\pm 32.018^{\circ}\text{F}$ ( $\pm 0.1^{\circ}\text{C}$ )	41 to 113°F (5 to 40°C)	W14.84 x H24.21 x D19.69
HRS030-R	2900 W			
<b>New</b> HRS050-R	5000 W			W14.84 x H38.42 x D23.31

**Compatible with power supplies in Europe, Asia, Oceania, and North, Central, and South America**

Single-phase 200 to 230 VAC (50/60 Hz)

**New**



Stainless steel panel specification (Option)

**HRS-R Series**

NAS40-67B

# Protection of the electrical unit: IP54

The board and electric parts are located inside the electrical box, where they can be protected from dust particles and water splashing.

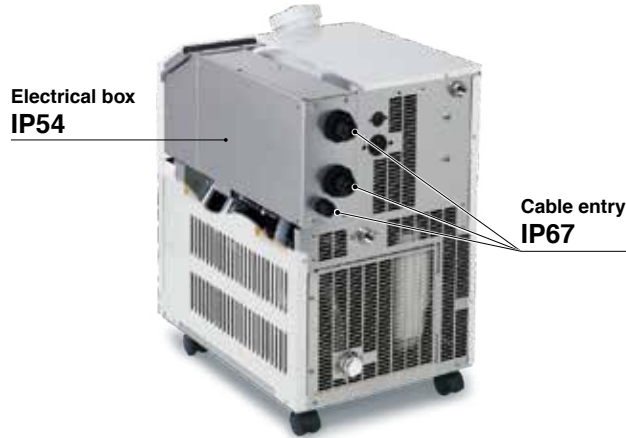

## A large capacity tank is available. (Option)

For easier maintenance, the tank capacity for the return circulating fluid from the customer's equipment has been increased. Now, from the high level line on the tank, an extra 5 liters of circulating fluid can be contained.

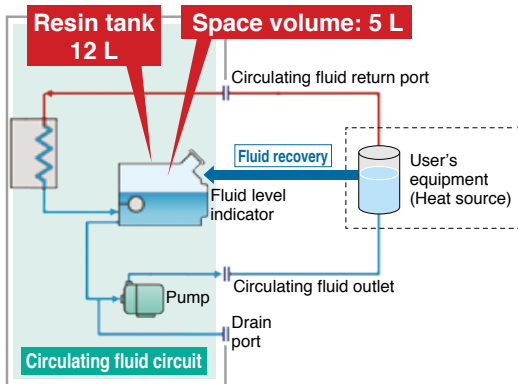

## Easy cleaning of the tank

There is a separate opening (with a cap) for cleaning the tank behind the circulating fluid fill port. Opening diameter:  $\phi 110$

Large capacity tank (Option)



## Shaped for easy supply of circulating fluid

The angled supply port facilitates the easy supply of circulating fluid.

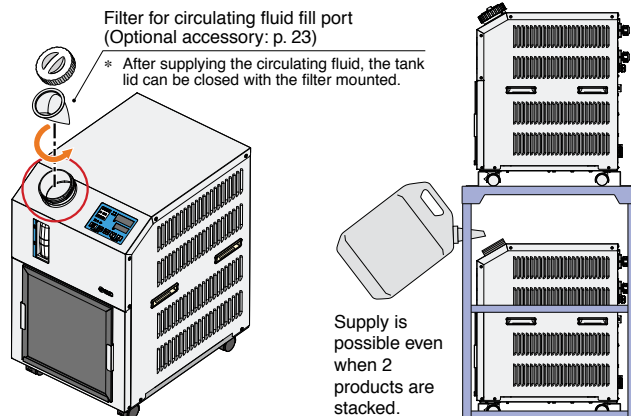

## Easy to check the circulating fluid level

High level line

Low level line

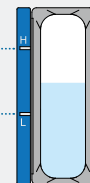

## With heating function

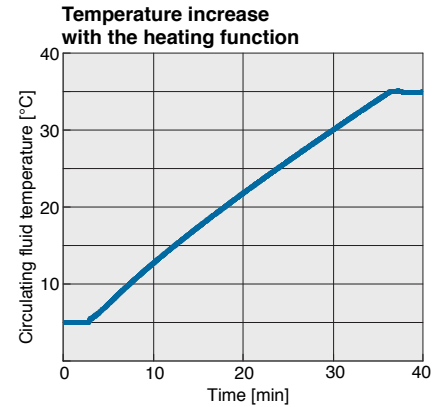
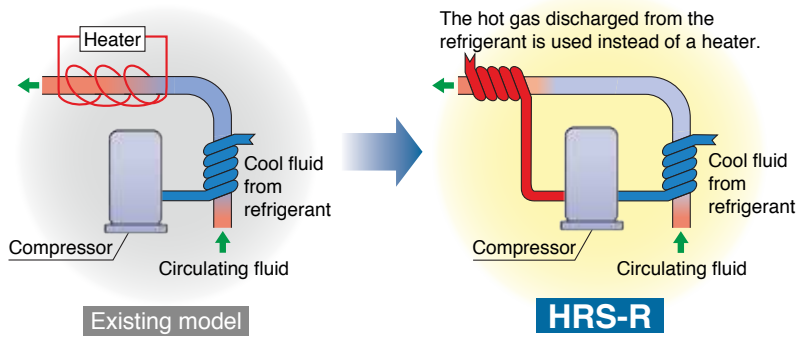

\* This is just an example diagram.

## Simple operation

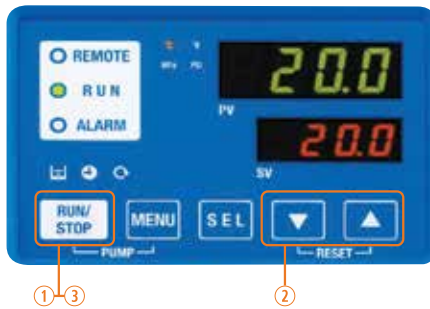

- Step ① Press the **RUN/STOP** key.
  - Step ② Adjust the temperature setting with the **▼/▲** keys.
  - Step ③ Press **RUN/STOP** key to stop operation.
- Easy operation



### Large digital display

The large digital display (7-segment and 4 digits) and 2-row display provide a clearer view of the current value (PV) and set value (SV).

## Convenient functions (Refer to the Operation Manual for details.)

**Timer operation function**  
 Timer for ON and OFF can be set in units of 0.5 h up to 99.5 h.  
 Ex.) Can be set to stop on Saturday and Sunday and restart on Monday morning

Ex. **SE.02 "ON timer"**

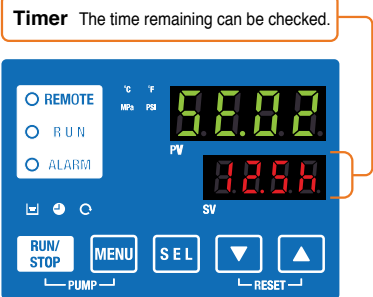

**Unit conversion function**  
 Temperature and pressure units can be changed.

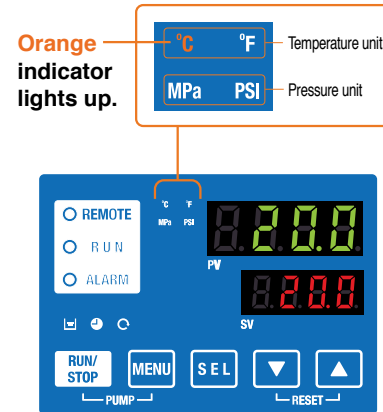

**Power failure auto-restart function**  
 Automatic restart after stoppage due to power failure, etc., is possible without pressing the **RUN/STOP** key, and remote operation is also possible.

**Anti-freezing operation function**  
 If the circulating fluid approaches its freezing point, for example, on a cold winter night, the pump operates automatically, and the heat generated by the pump warms the circulating fluid, preventing freezing.

**Key-lock function**  
 Can be set in advance to protect the set values from being changed by pressing keys by mistake.

**Function to output a signal for completion of preparation**  
 Notifies by communication when the temperature reaches the pre-set temperature range

**Independent operation of the pump**  
 The pump can be operated independently while the chiller is powered off. This allows you to check for leakages in piping and to remove the air.

**Thermo-chiller** Environmentally Resistant Type **HRS-R Series**



**Reduced maintenance hours for the pump**

**Now with a magnet pump\*1**

Due to the adoption of a sealless pump, no external leakage of the circulating fluid occurs. Also, periodic checking for pump leakage and replacement of the mechanical seal are not necessary.

\*1 For products with the high-pressure pump option and for the HRS050, a mechanical seal pump is used.

**Toolless inspection and cleaning of air-cooled condenser**

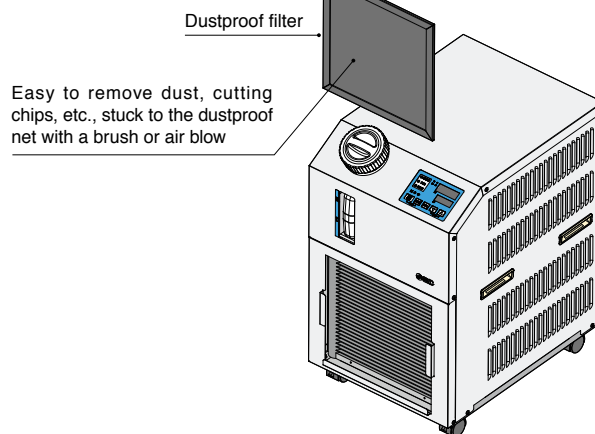

Easy to remove dust, cutting chips, etc., stuck to the dustproof net with a brush or air blow

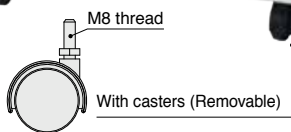

**Power supply (24 VDC) available**

Power can be supplied from the connector on the rear side of the HRS-R to external switches, etc.

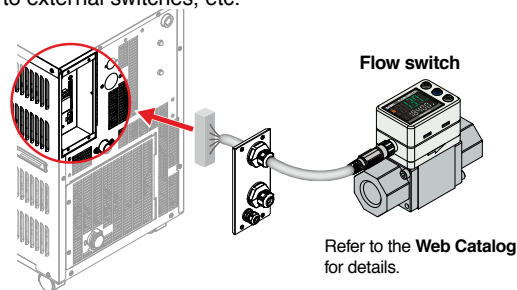

Refer to the Web Catalog for details.



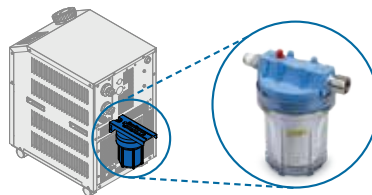

**Particle filter set** p. 22



Removes foreign matter in the circulating fluid  
Effective in preventing foreign matter from entering the user's equipment and chiller

- Prevents pump malfunction

**Variations**

Model	Cooling method	Cooling capacity [W] (50/60 Hz)	Single-phase 200 to 230 VAC (50/60 Hz)	Option p. 17	Optional accessories p. 19	International standards
	Air-cooled refrigeration	HRS018-R	1700/1900	●	· With earth leakage breaker · With automatic fluid fill function · Large capacity tank specification · High-pressure pump mounted (* The HRS050 cannot be selected.) · Stainless steel panel specification · SI unit only	 (UL規格)
		HRS030-R	2500/2900	●		
		HRS050-R	4500/5000	●		

## Self-diagnosis function and check display

### Display of 31 types of alarm codes For details, refer to page 15.

Operation is monitored at all times by the integrated sensor. Should any error occur, the self-diagnosis result is displayed by the applicable alarm code (31 types). This makes it easier to identify the cause of the alarm. Can be used before requesting service

#### Changeable alarm set values

Setting item	Set value
Circulating fluid discharge temperature rise	5 to 48°C
Circulating fluid discharge temperature drop	1 to 39°C
Circulating fluid discharge pressure rise	0.05 to 0.75 MPa*1
Circulating fluid discharge pressure drop	0.05 to 0.18 MPa*1

\*1 Set values vary depending on the model.

#### Ex. AL01 "Low level in tank"

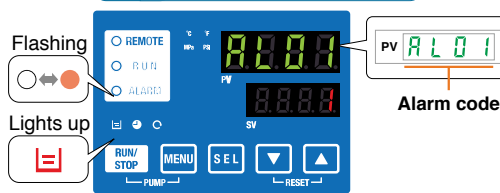

Alarm codes can be used for the notification of upcoming recommended maintenance. The codes notify you when it's time to check the pump and fan motor. Helpful for facility maintenance

#### Ex. AL28 "Pump maintenance"

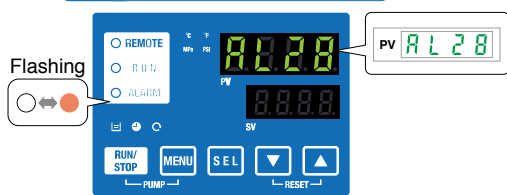

#### Check display

The internal temperature, pressure, and operating time of the product are displayed.

#### Ex. drv. "Accumulated operating time"

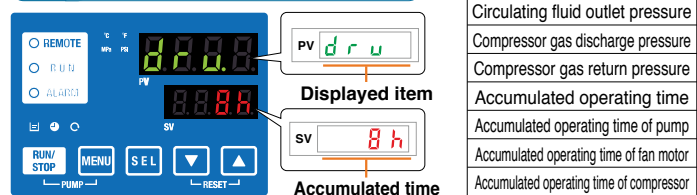

Displayed item
Circulating fluid outlet temperature
Circulating fluid return temperature
Compressor gas temperature
Circulating fluid outlet pressure
Compressor gas discharge pressure
Compressor gas return pressure
Accumulated operating time
Accumulated operating time of pump
Accumulated operating time of fan motor
Accumulated operating time of compressor

## Communication function

Serial communication (RS232C/RS485) and contact I/Os (2 inputs and 3 outputs) are equipped as standard. This allows for communication with the user's equipment and system construction, depending on the application. A 24 VDC output can be also provided and is available for use with flow switches (SMC's PF3W, etc.).

### Ex. 1 Remote signal I/O through serial communication

Remote operation is enabled (to start and stop operation) through serial communication.

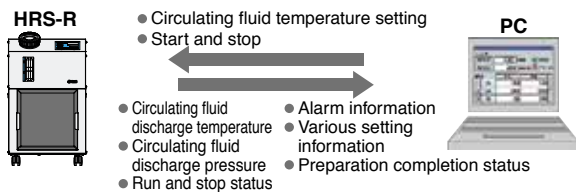

### Ex. 2 Remote operation signal input

One of the contact inputs is used for remote operation and the other is used to monitor the flow of a flow switch. This is where their alarm outputs are taken in.

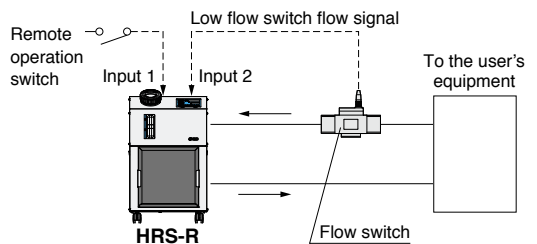

Power for flow switches (24 VDC) can be supplied by the thermo-chiller.

### Ex. 3 Alarm and operation status (start, stop, etc.) signal output

The alarm and status generated in the product are assigned to 3 output signals based on their contents, which can then be output.

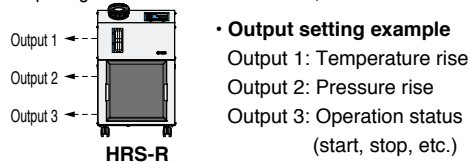

### Application Examples



## Global Supply Network









**SMC has a comprehensive network in the global market.**

We now have a presence of more than 500 branch offices and distributors in 83 countries and regions worldwide, such as Asia, Oceania, North/Central/South America, and Europe. With this global network, we are able to provide a global supply of our substantial range of products and high-quality customer service. We also provide full support to local factories, foreign manufacturing companies, and Japanese companies in each country.



## SMC Thermo-chiller Variations

Lots of variations are available according to the users' requirements.

Series	Temperature stability [°C]	Set temperature range [°C]	Cooling capacity [kW]													Environment	International standards	
			1.2	1.8	2.4	3	4	5	6	9	10	15	20	25	28			
 <b>HRSE Basic type</b>	±2.0	10 to 30	●	●	●												Indoor use	CE (Only 230 VAC type)
 <b>HRS Standard type</b>	±0.1	5 to 40	●	●	●	●	●	●	●								Indoor use	CE Ⓜ (Only 60 Hz)
 <b>HRS-R Environmentally resistant type</b>	±0.1	5 to 40		●		●		●									Indoor use Electrical box: IP54	CE
 <b>HRS090 Standard type</b>	±0.5	5 to 35								●							Indoor use	CE (400 V as standard)
 <b>HRS100/150 Standard type</b>	±1.0	5 to 35									●	●					Outdoor installation IPX4	CE (400 V as standard)
 <b>HRSH090 Inverter type</b>	±0.1	5 to 40								●							Indoor use	CE (400 V as standard, 200 V as an option) Ⓜ (Only 200 V as an option)
 <b>HRSH Inverter type</b>	±0.1	5 to 35									●	●	●	●	●		Outdoor installation IPX4	CE (400 V as standard, 200 V as an option) Ⓜ (Only 200 V as an option)
 <b>HRL Inverter dual type</b>	CH1	±0.1	15 to 25							●			●	●			Indoor use	CE
	CH2	±0.5	20 to 40													1.0 kW (Max. 1.5 kW)		

## Circulating Fluid Line Equipment

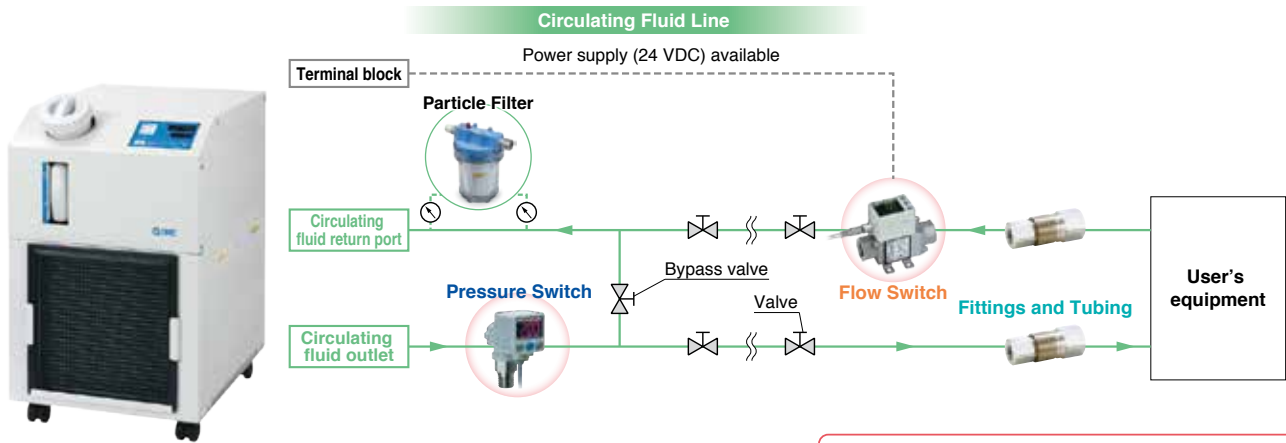

For the control of pressure and flow rate:  
 The digital display makes these aspects **visible**.

**Flow Switch:** Monitors the flow rate and temperature of the circulating fluid

Refer to the Web Catalog for details.

**3-Color Display  
 Digital Flow Switch for Water PF3W**  
 Integrated with temperature sensor  
 PVC Piping

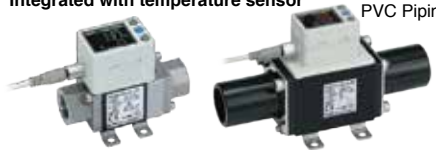

**3-Color Display  
 Electromagnetic  
 Digital Flow Switch  
 LFE**



**Digital Flow Switch for  
 Deionized Water and Chemical Liquids PF2D**  
**4-Channel Flow Monitor PF2□200**



**Pressure Switch:** Monitors the pressure of the circulating fluid and facility water

Refer to the Web Catalog for details.

**2-Color Display  
 High-Precision Digital  
 Pressure Switch ISE80**



**Pressure Sensor  
 for General Fluids  
 PSE56□, 57□  
 Pressure Sensor  
 Controller  
 PSE200, 300, 300AC**



**Particle Filter**



p. 22

**Fittings and Tubing**

Refer to the Web Catalog for details.

**S Coupler KK**



**S Coupler/Stainless Steel  
 (Stainless Steel 304) KKA**



**Tubing T□**



**Metal One-touch Fittings KQB2**



**Stainless Steel 316  
 One-touch Fittings KQG2**



**Stainless Steel 316 Insert Fittings KFG2**



**Fluoropolymer Fittings LQ**



Series	Material
T	Nylon
TU	Polyurethane
TH	FEP (Fluoropolymer)
TD	Modified PTFE (Soft fluoropolymer)
TL	Super PFA
TLM	PFA

## UNIT CONVERSIONS

	unit	conversion	result		unit	conversion	result
length	m	x 3.28	psi	pressure	MPa	x 145	psi
	mm	x 0.04	psi		kPa	÷ 6.895	psi
mass	g	x 0.04	°F	temperature	°C	x1.8 then add 32	°F
volume	cm <sup>3</sup>	÷ 16.387	ft-lb	torque	N-m	x 0.738	ft-lb
	L	x 61.024	lbf	force	N	÷ 4.448	lbf
speed	mm/s	÷ 25.4	cfm	flow	L/min	÷ 28.317	cfm



# CONTENTS

## **HRS-R Series** Environmentally Resistant Type



### Thermo-chiller HRS-R Series

How to Order/Specifications <b>Single-phase 200 to 230 VAC</b> .....	p. 9
Cooling Capacity .....	p. 10
Heating Capacity .....	p. 11
Pump Capacity .....	p. 11
Dimensions .....	p. 12
Recommended External Piping Flow .....	p. 14
Cable Specifications .....	p. 14
Operation Display Panel .....	p. 15
Alarm .....	p. 15
Communication Functions .....	p. 16

#### ● Options

With Earth Leakage Breaker .....	p. 17
With Automatic Fluid Fill Function .....	p. 17
Large Capacity Tank Specification .....	p. 17
High-Pressure Pump Mounted .....	p. 18
Stainless Steel Panel Specification .....	p. 18
SI Unit Only .....	p. 18

#### ● Optional Accessories

① Anti-Quake Bracket .....	p. 19
② Piping Conversion Fitting .....	p. 19
③ Piping Conversion Fitting (For Option) .....	p. 20
④ Concentration Meter .....	p. 20
⑤ Bypass Piping Set .....	p. 21
⑥ Particle Filter Set .....	p. 22
⑦ Dustproof Filter .....	p. 23
⑧ Separately-Installed Power Transformer .....	p. 23
⑨ Filter for Circulating Fluid Fill Port .....	p. 23

#### ● Cooling Capacity Calculation

Required Cooling Capacity Calculation .....	p. 24
Precautions on Cooling Capacity Calculation .....	p. 25
Circulating Fluid Typical Physical Property Values .....	p. 25

Specific Product Precautions .....	p. 26
------------------------------------	-------



**How to Order**

Air-cooled refrigeration

**HRS 018 - A - 20 - R**

Stainless steel panel specification (Option)

Stainless steel panel specification (Option)

**Cooling capacity**

Symbol	Cooling capacity
<b>018</b>	1700/1900 W (50/60 Hz)
<b>030</b>	2500/2900 W (50/60 Hz)
<b>050</b>	4500/5000 W (50/60 Hz)

**Cooling method**

Symbol	Type
<b>A</b>	Air-cooled refrigeration

**Pipe thread type**

Symbol	Type
<b>Nil</b>	Rc
<b>F</b>	G (with Rc-G conversion fitting set)
<b>N</b>	NPT (with Rc-NPT conversion fitting set)

**Power supply**

<b>20</b>	Single-phase 200 to 230 VAC (50/60 Hz)
-----------	--

**Environmentally resistant type**  
**R** Environmentally resistant type

**Option**

Symbol	Description	Applicable model
<b>Nil</b>	None	HRS018/030/050
<b>B</b>	With earth leakage breaker	
<b>J</b>	With automatic fluid fill function	
<b>L</b>	Large capacity tank specification	
<b>T</b>	High-pressure pump mounted*1	HRS018/030
<b>V</b>	Stainless steel panel specification	HRS018/030/050
<b>W</b>	SI unit only	

- When multiple options are combined, indicate symbols in alphabetical order.
- \*1 • The cooling capacity will decrease by about 300 W from the value in the catalog.
- The pump has a mechanical seal in it and leakage could occur depending on circulating fluid quality. We recommend you to use the particle filter kit, HRS-PF003, as a preventive measure.

**Specifications** \* There are different values from standard specifications. Refer to page 17 for details.

Model	HRS018-A□-20-□-R	HRS030-A□-20-□-R	HRS050-A□-20-□-R
<b>Cooling method</b>	Air-cooled refrigeration		
<b>Refrigerant</b>	R410A (HFC)		
<b>Refrigerant charge</b> [kg]	0.39		0.77
<b>Control method</b>	PID control		
<b>Ambient temperature/Humidity/Altitude*1</b> [°C]	Temperature: 5 to 45°C, Humidity: 30 to 70%, Altitude: less than 3000 m		
<b>Circulating fluid*2</b>	Tap water, 15% ethylene glycol aqueous solution*4		
<b>Set temperature range*1</b> [°C]	5 to 40		
<b>Cooling capacity*3</b> (50/60 Hz) [W]	1700/1900	2500/2900	4500/5000
<b>Heating capacity*3</b> (50/60 Hz) [W]	430/540	430/540	830/1200
<b>Temperature stability*5</b> [°C]	±0.1		
<b>Rated flow*6,7</b> (50/60 Hz) [L/min]	7 (0.13 MPa)/7 (0.18 MPa)		23 (0.21 MPa)/28 (0.28 MPa)
<b>Maximum flow rate</b> (50/60 Hz) [L/min]	27/29		33/40
<b>Maximum pump head</b> (50/60 Hz) [m]	14/19		50
<b>Output</b> [W]	200		550
<b>Tank capacity</b> [L]	Approx. 5		
<b>Port size</b>	Rc1/2		
<b>Fluid contact material</b>	Stainless steel, Copper (Heat exchanger brazing), Bronze, Alumina ceramic, Carbon, PP, PE, POM, FKM, EPDM, PVC		
<b>Power supply</b>	Single-phase 200 to 230 VAC (50/60 Hz) Allowable voltage range ±10%		
<b>Applicable earth leakage breaker capacity*8</b> [A]	10		20
<b>Rated operating current</b> [A]	5.1/5.6	5.4/6.1	8.9/11.5
<b>Rated power consumption*3</b> (50/60 Hz) [kVA]	1.0/1.1	1.1/1.2	1.8/2.3
<b>Electrical box protection level</b>	IP54 (Cable entry: IP67)		
<b>Noise level*9</b> (50/60 Hz) [dB]	62/65		66/69
<b>Accessories</b>	Fitting (for drain outlet) 1 pc., Input/output signal connector 1 pc., Operation Manual (for installation/operation) 1, Alarm code list sticker 1, Ferrite core (for communication) 1 pc. The power supply cable should be prepared by the user.		
<b>Weight*10</b> [kg]	45		69

\*1 No condensation should be present.  
 \*2 If tap water is used, use water that is compliant with the Water Quality Standards of the Japan Refrigeration and Air Conditioning Industry Association (JRA GL-02-1994 cooling water system - circulating type - make-up water).  
 \*3 ① Ambient temperature: 25°C, ② Circulating fluid temperature: 20°C, ③ Circulating fluid at the rated flow, ④ Circulating fluid: Tap water  
 Refer to the cooling capacity graph on page 10 for details.  
 \*4 Use a 15% ethylene glycol aqueous solution if operating in a place where the circulating fluid temperature is 10°C or less.  
 \*5 Temperature at the thermo-chiller outlet when the circulating fluid flow is at the rated flow

and the circulating fluid outlet and return port are directly connected  
 The installation environment and power supply are within the specification range and stable.  
 \*6 The capacity at the thermo-chiller outlet when the circulating fluid temperature is 20°C  
 \*7 The required minimum flow rate for maintaining the cooling capacity or temperature stability  
 The specification of the cooling capacity and the temperature stability may not be satisfied if the flow rate is lower than the rated flow. (In such a case, use a bypass piping set (sold separately).)  
 \*8 Purchase an earth leakage breaker with a sensitivity current of 30 mA separately. (A product with an optional earth leakage breaker (option B) is also available.)  
 \*9 Front: 1 m, height: 1 m, stable with no load, Other conditions → See \*3.  
 \*10 Weight in the dry state without circulating fluids

\* If the product is used at an altitude of 1000 m or higher, refer to "Operating Environment/Storage Environment" (page 27) Item 14 "For altitudes of 1000 m or higher."  
 \* For models with a high-pressure pump mounted (-T), the cooling capacity will decrease by about 300 W from each graph.

**Cooling Capacity**

**HRS018-A□-20-□-R**

[50 Hz]

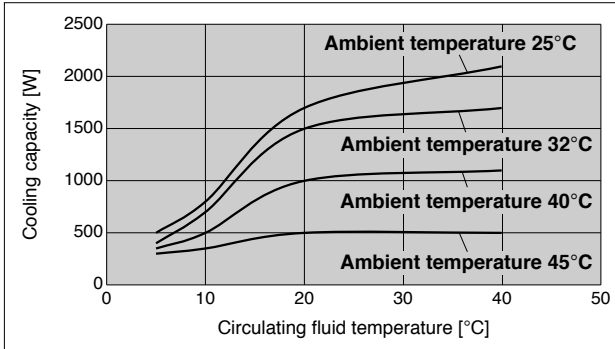

[60 Hz]

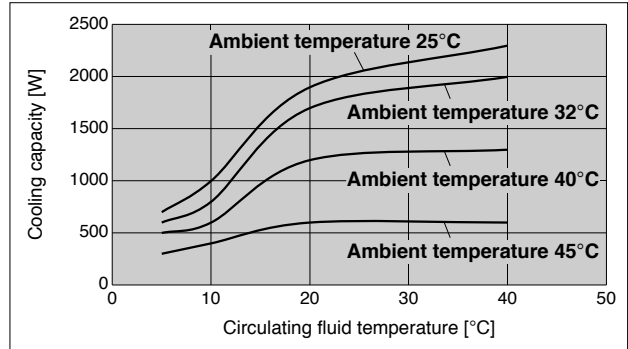

**HRS030-A□-20-□-R**

[50 Hz]

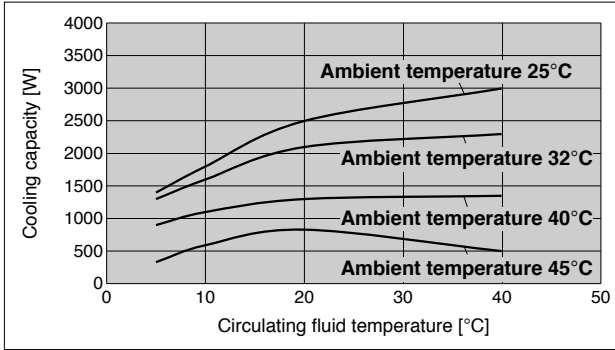

[60 Hz]

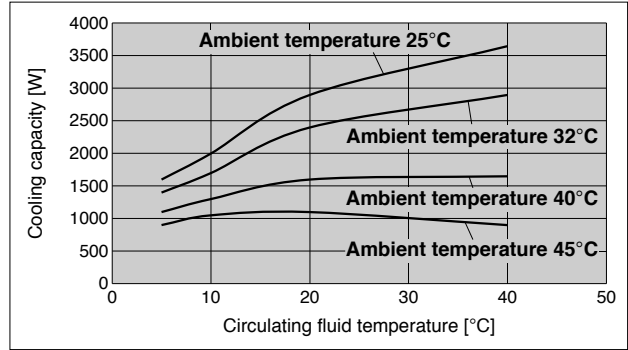

**HRS050-A□-20-□-R**

[50 Hz]

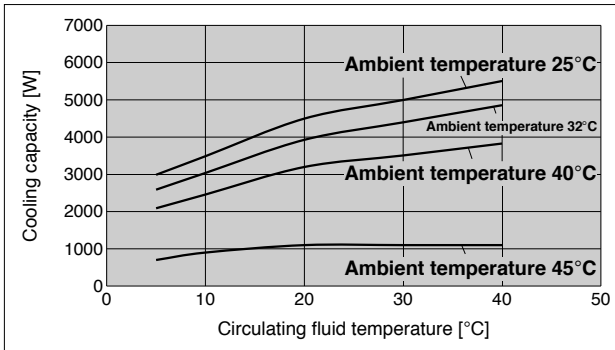

[60 Hz]

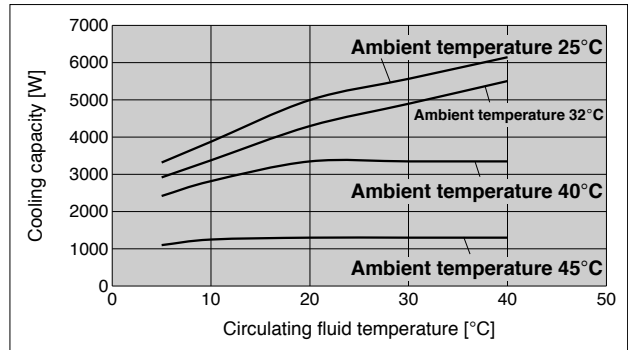

**Heating Capacity**

**HRS<sup>018</sup><sub>030</sub>-A-20-R** [50 Hz]

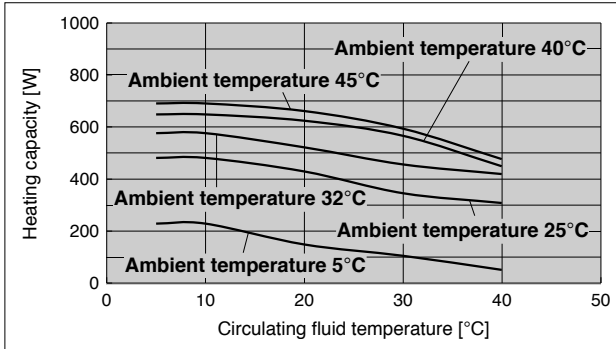

[60 Hz]

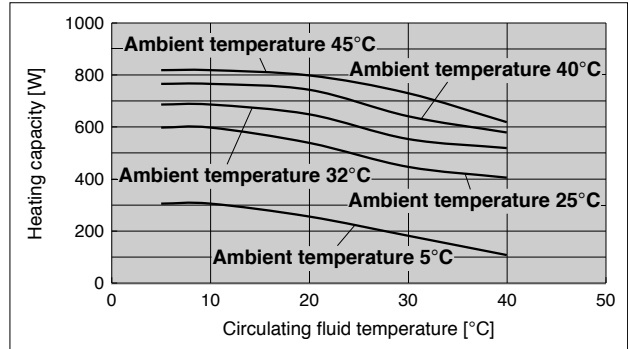

**HRS050-A□-20-□-R** [50 Hz]

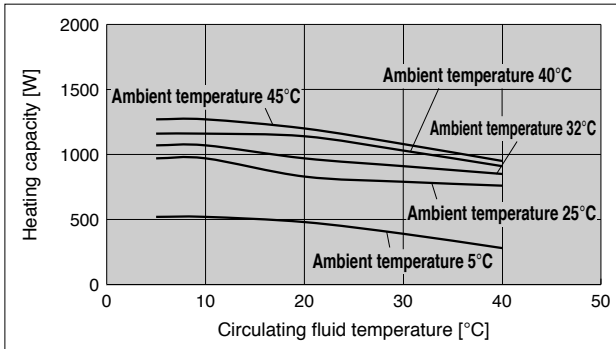

[60 Hz]

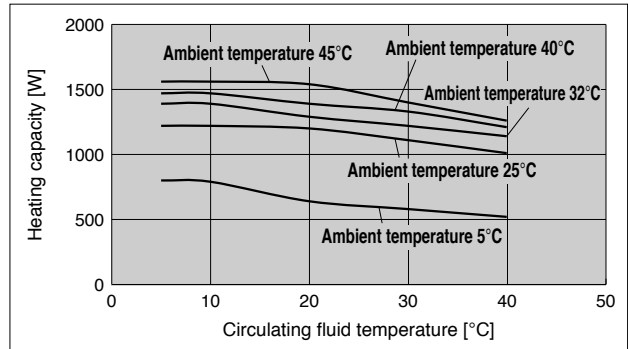

**Pump Capacity**

**HRS<sup>018</sup><sub>030</sub>-A-20-R (Single-phase 200 to 230 VAC)**

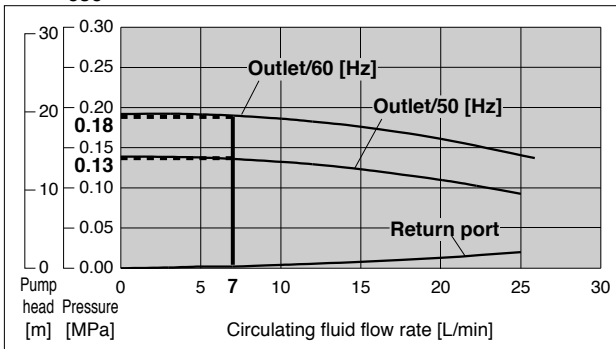

**HRS050-A□-20-□-R (Single-phase 200 to 230 VAC)**

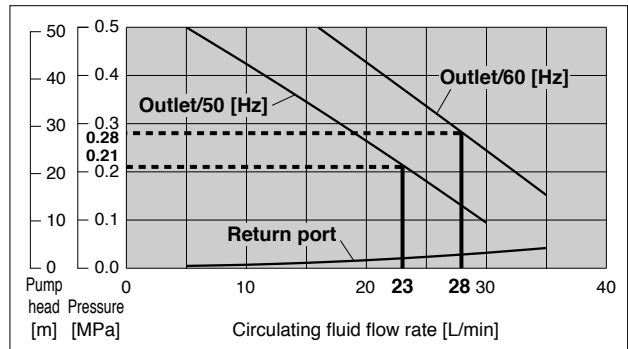

**Dimensions**

**HRS018-A-20-R**  
**HRS030-A-20-R**

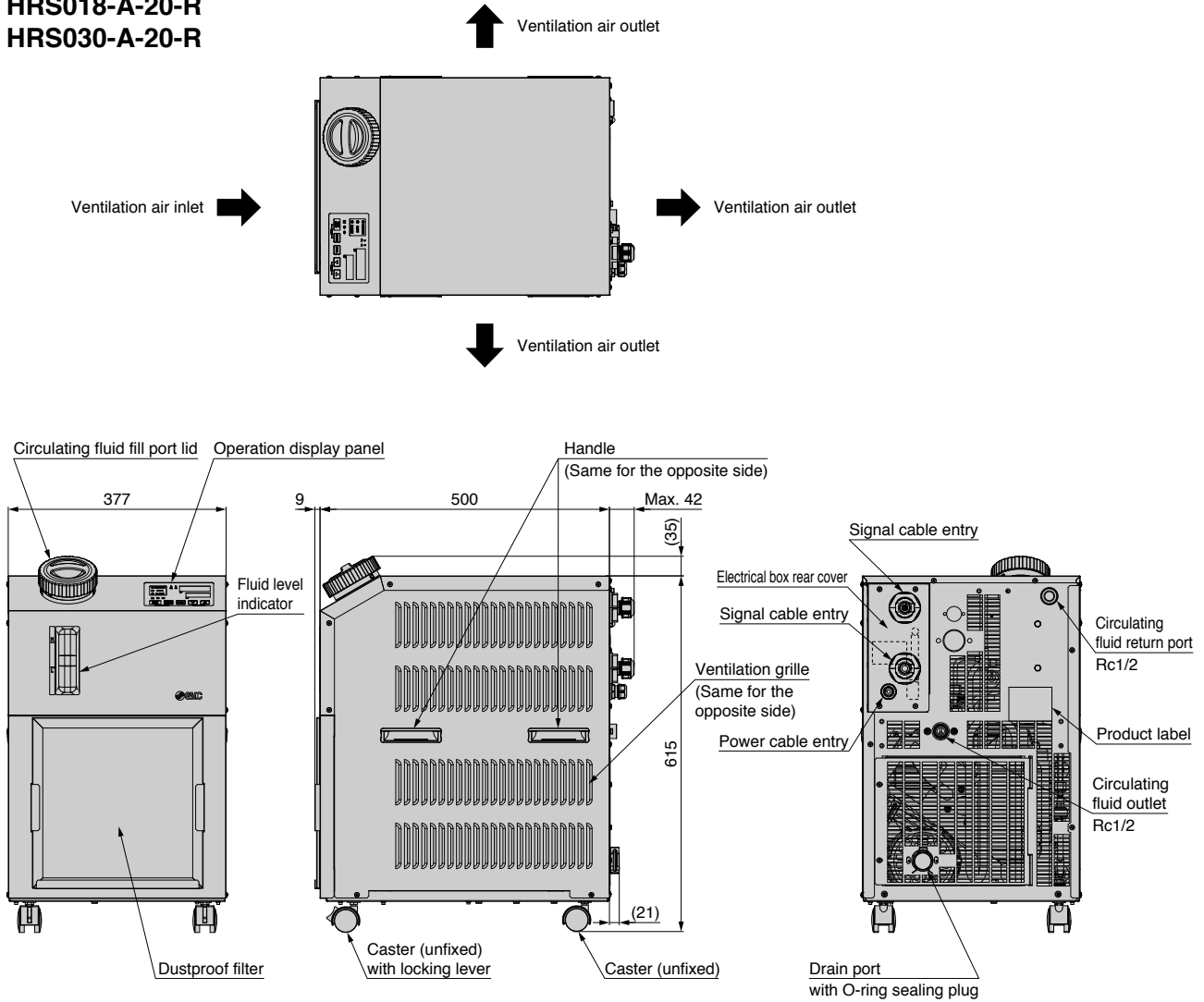

**Connection for the power cable and signal cable**  
**(The figure does not include the electrical box rear cover.)**

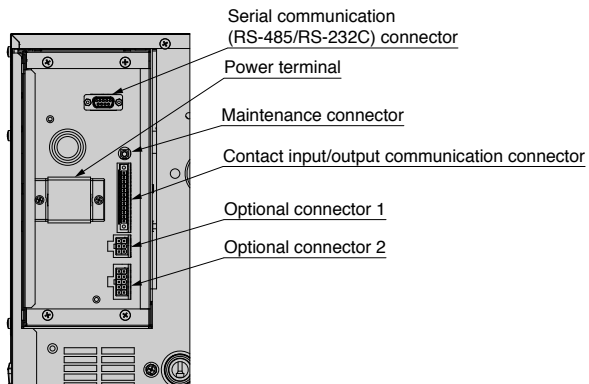

**Thermo-chiller Environmentally Resistant Type HRS-R Series**

**Dimensions**

**HRS050-A-20-R**

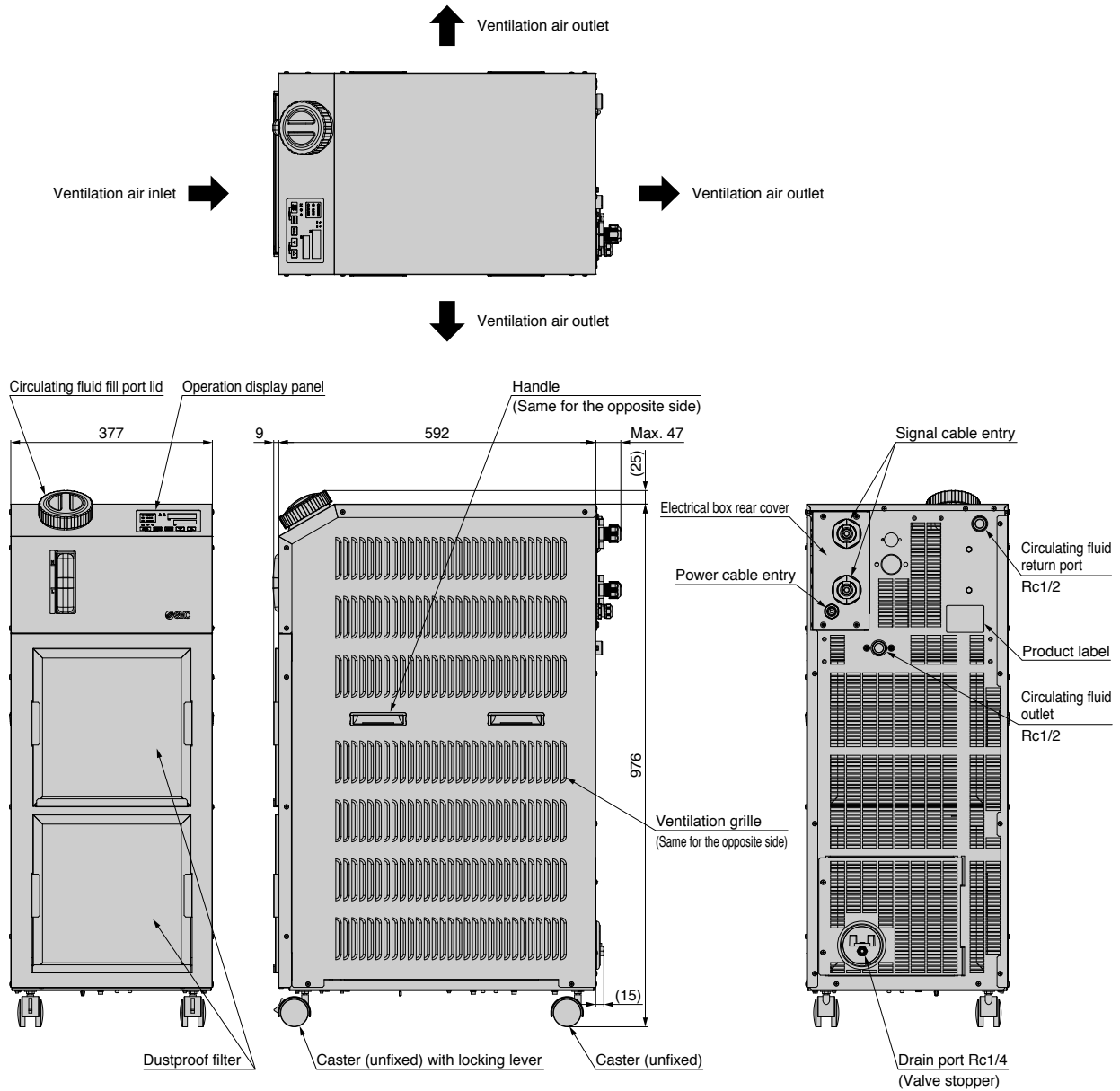

**Connection for the power cable and signal cable  
(The figure does not include the electrical box rear cover.)**

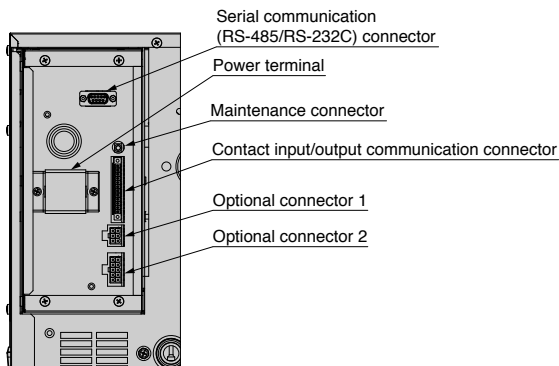

## Recommended External Piping Flow

External piping circuit is recommended as shown below.

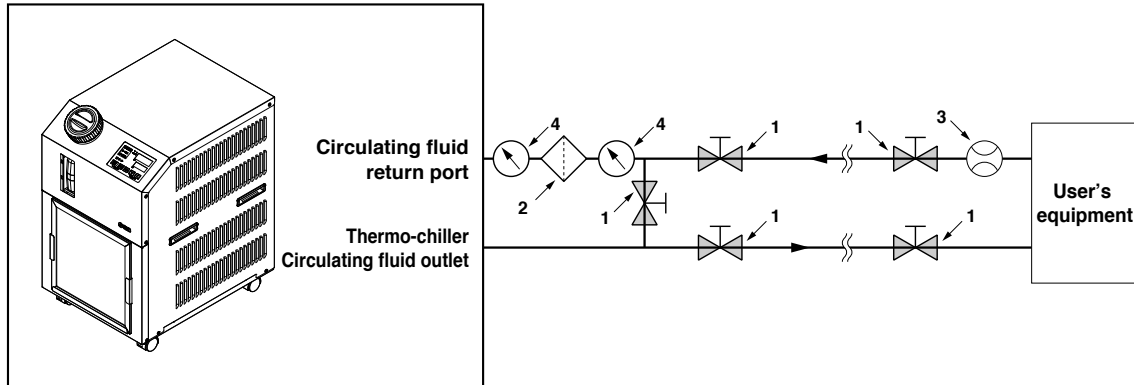

No.	Description	Size	Recommended part no.	Note
1	Valve	Rc1/2	—	—
2	Filter	Rc1/2 20 μm	HRS-PF□□□□	If foreign matter with a size of 20 μm or more are likely to enter, install the particle filter. For the recommended filter, refer to the optional accessory HRS-PF□□□□ (page 22).
3	Flow meter	0 to 50 L/min	—	—
4	Pressure gauge	0 to 1.0 MPa	—	—
5	Others (pipe, hose, etc.)	ø15 or more	—	—

## Cable Specifications

### Power Cable Specifications

Applicable model	Rated value for thermo-chiller			Power cable example	
	Power supply	Applicable breaker rated current	Terminal screw	Cable size	Recommended crimped terminal
HRS018-A□-20-R HRS030-A□-20-R	Single-phase 200 to 230 VAC (50/60 Hz)	10 A	M3.5	3 cores x 2.0 mm <sup>2</sup> (3 cores x AWG14) * Including grounding cable Sheath O.D.: ø8.5 to ø11.5	R2-3.5
HRS018-A□-20-B-R HRS030-A□-20-B-R			M5 (Ground terminal: M4)		R2-5 (Ground: R2-4)
HRS018-A□-20-T-R HRS030-A□-20-T-R		15 A	M3.5		R2-3.5
HRS018-A□-20-BT-R HRS030-A□-20-BT-R			M5 (Ground terminal: M4)		R2-5 (Ground: R2-4)
HRS050-A□-20-R		20 A	M3.5		R2-3.5
HRS050-A□-20-B-R			M5 (Ground terminal: M4)		R2-5 (Ground: R2-4)

\* Option B features a built-in breaker as shown in the chart above.

## Operation Display Panel

The basic operation of this unit is controlled through the operation display panel on the front of the product.

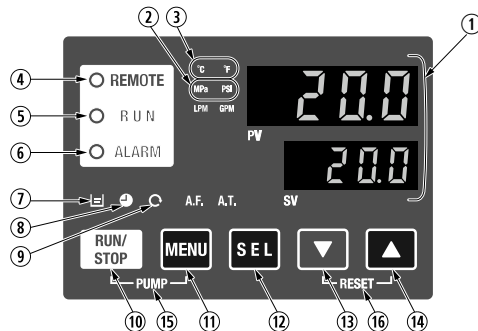

No.	Description	Function
①	<b>Digital display (7-segment, 4 digits)</b>	<b>PV</b> Displays the circulating fluid current discharge temperature and pressure and alarm codes and other menu items (codes).
		<b>SV</b> Displays the circulating fluid discharge temperature and the set values of other menus.
②	<b>[°C] [°F] lamp</b>	Equipped with a unit conversion function. Displays the unit of display temperature (default setting: °C).
③	<b>[MPa] [PSI] lamp</b>	Equipped with a unit conversion function. Displays the unit of display pressure (default setting: MPa).
④	<b>[REMOTE] lamp</b>	Enables remote operation (start and stop) by communication. Lights up during remote operation.
⑤	<b>[RUN] lamp</b>	Lights up when the product is started, and goes off when it is stopped. Flashes during stand-by for stop or anti-freezing function, or independent operation of the pump.
⑥	<b>[ALARM] lamp</b>	Flashes with buzzer when alarm occurs.
⑦	<b>[L] lamp</b>	Lights up when the surface of the fluid level indicator falls below the L level.
⑧	<b>[●] lamp</b>	Equipped with a timer for start and stop. Lights up when this function is operated.
⑨	<b>[○] lamp</b>	Equipped with a power failure auto-restart function, which restarts the product automatically after stopped due to a power failure, is provided. Lights up when this function is operated.
⑩	<b>[RUN/STOP] key</b>	Makes the product start or stop.
⑪	<b>[MENU] key</b>	Shifts the main menu (display screen of circulating fluid discharge temperature and pressure) and other menus (for monitoring and entry of set values).
⑫	<b>[SEL] key</b>	Changes the item in menu and enters the set value.
⑬	<b>[▼] key</b>	Decreases the set value.
⑭	<b>[▲] key</b>	Increases the set value.
⑮	<b>[PUMP] key</b>	Press the [MENU] and [RUN/STOP] keys simultaneously. The pump starts running independently to make the product ready for start-up (release the air).
⑯	<b>[RESET] key</b>	Press the [▼] and [▲] keys simultaneously. The alarm buzzer is stopped and the [ALARM] indicator is reset.

## Alarm

This unit has 31 types of alarms as standard, and displays each of them by its alarm code on the PV screen with the [ALARM] lamp ([LOW LEVEL] lamp) lit up on the operation display panel. The alarm can be read out through communication.

Alarm code	Alarm message	Operation status	Alarm code	Alarm message	Operation status
AL01	Low level in tank	Stop* <sup>1</sup>	AL18	Compressor overload	Stop
AL02	High circulating fluid discharge temperature	Stop	AL19* <sup>2</sup>	Communication error* <sup>2</sup>	Continue* <sup>1</sup>
AL03	Circulating fluid discharge temperature rise	Continue* <sup>1</sup>	AL20	Memory error	Stop
AL04	Circulating fluid discharge temperature drop	Continue* <sup>1</sup>	AL21	DC line fuse cut	Stop
AL05	High circulating fluid return temperature (60°C)	Stop	AL22	Circulating fluid discharge temperature sensor failure	Stop
AL06	High circulating fluid discharge pressure	Stop	AL23	Circulating fluid return temperature sensor failure	Stop
AL07	Abnormal pump operation	Stop	AL24	Compressor intake temperature sensor failure	Stop
AL08	Circulating fluid discharge pressure rise	Continue* <sup>1</sup>	AL25	Circulating fluid discharge pressure sensor failure	Stop
AL09	Circulating fluid discharge pressure drop	Continue* <sup>1</sup>	AL26	Compressor discharge pressure sensor failure	Stop
AL10	High compressor intake temperature	Stop	AL27	Compressor intake pressure sensor failure	Stop
AL11	Low compressor intake temperature	Stop	AL28	Pump maintenance	Continue
AL12	Low super heat temperature	Stop	AL29	Fan motor maintenance	Continue
AL13	High compressor discharge pressure	Stop	AL30	Compressor maintenance	Continue
AL15	Refrigerating circuit pressure (high pressure side) drop	Stop	AL31* <sup>2</sup>	Contact 1 input signal detection	Stop* <sup>1</sup>
AL16	Refrigerating circuit pressure (low pressure side) rise	Stop	AL32* <sup>2</sup>	Contact 2 inputs signal detection	Stop* <sup>1</sup>
AL17	Refrigerating circuit pressure (low pressure side) drop	Stop			

\*1 "Stop" or "Continue" are default settings. Users can change them to "Continue" and "Stop". For details, refer to the Operation Manual.

\*2 "AL19, AL31, AL32" are disabled in the default setting. If this function is necessary, it should be set by the user, referring to the Operation Manual.



## Communication Functions

### Contact Input/Output

Item	Specifications	
Connector type (to the product/to the socket (Accessory))	MC 1,5/12-GF-3,5/MC 1,5/12-STF-3,5 (made by PHOENIX CONTACT) Option B: DFK-MC1,5/12-GF-3,81 / MC1,5/12-STF-3,81 (made by PHOENIX CONTACT)	
Input signal	Insulation method	Photocoupler
	Rated input voltage	24 VDC
	Operating voltage range	21.6 VDC to 26.4 VDC
	Rated input current	5 mA TYP
	Input impedance	4.7 kΩ
Contact output signal	Rated load voltage	48 VAC or less/30 VDC or less
	Maximum load current	500 mA AC/DC (Resistance load)
	Minimum load current	5 VDC 10 mA
Output voltage	24 VDC ±10% 0.5 A MAX	
Circuit diagram	<p>To the thermo-chiller    User's equipment side</p> <p>24 VDC (0.5 A MAX)*2</p> <p>24 VCOM</p> <p>12 24 VDC output</p> <p>11 24 VCOM output</p> <p>10 Run/Stop signal</p> <p>9 Not set when shipping from factory</p> <p>8 Not set when shipping from factory</p> <p>7 Not set when shipping from factory</p> <p>6 Operation status signal</p> <p>5 Operation status signal</p> <p>4 Remote signal</p> <p>3 Remote signal</p> <p>2 Alarm signal</p> <p>1 Alarm signal</p> <p>Internal circuit</p> <p>Settings at the time of shipment from the factory*1 (Users can modify the settings.)</p>	

\*1 The pin numbers and output signals can be set by the user. For details, refer to the Operation Manual.

\*2 When using with optional accessories, depending on the accessory, the allowable current of 24 VDC devices will be reduced. Refer to the Operation Manual of the optional accessories for details.

### Serial Communication

The serial communication (RS-485/RS-232C) enables the following items to be written and read out.

For details, refer to the Operation Manual for communication.

Writing	Readout
Run/Stop Circulating fluid temperature setting (SV)	Circulating fluid present temperature Circulating fluid discharge pressure Status information Alarm occurrence information

Item	Specifications
Connector type	D-sub 9-pin, Female connector (Mounting screw: M2.6 x 0.45)
Protocol	Modicon Modbus compliant/Simple communication protocol
Standards	EIA standard RS-485                      EIA standard RS-232C
Circuit diagram	<p>To the thermo-chiller    User's equipment side</p> <p>1 SD+</p> <p>2 SG</p> <p>3 SD-</p> <p>Internal circuit</p> <p>To the thermo-chiller    User's equipment side</p> <p>1 RD</p> <p>2 SD</p> <p>3 SG</p> <p>Internal circuit</p>

\* The terminal resistance of RS-485 (120 Ω) can be switched by the operation display panel. For details, refer to the Operation Manual. Do not connect other than in the way shown above, as it can result in failure.

# HRS-R Series Options

\* Options have to be selected when ordering the thermo-con. It is not possible to add them after purchasing the unit.

## **B** Option symbol

### With Earth Leakage Breaker

HRS  -A-20-B-R

● With earth leakage breaker

In the event of a short circuit, overcurrent or overheating, the earth leakage breaker will automatically shut off the power supply.

Model	Rated current [A]	Sensitivity of leak current [mA]
HRS018-A <input type="checkbox"/> -20-B <input type="checkbox"/> -R HRS030-A <input type="checkbox"/> -20-B <input type="checkbox"/> -R	10	30
HRS0 <input type="checkbox"/> <input type="checkbox"/> -A <input type="checkbox"/> -20-B <input type="checkbox"/> T <input type="checkbox"/> -R (Option T [High-pressure pump mounted])	15	30
HRS050-A <input type="checkbox"/> -B <input type="checkbox"/> -R	20	30

\* When the type with an earth leakage breaker is selected, the weight increases by 2 kg.

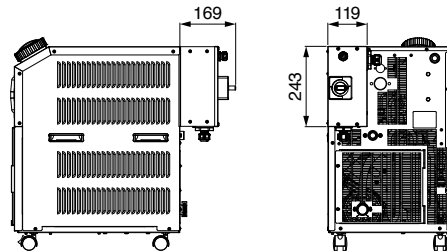
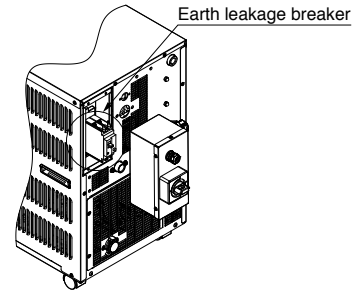

## **J** Option symbol

### With Automatic Fluid Fill Function

HRS  -A-20-J-R

● With automatic fluid fill function

By installing this at the automatic fluid fill port, the circulating fluid can be automatically supplied to the product using a built-in solenoid valve for a fluid fill while the circulating fluid is decreasing.

Applicable model	HRS018/030/050-A-20-J-R
Fluid fill method	Built-in solenoid valve for automatic fluid fill
Fluid fill pressure [MPa]	0.2 to 0.5

\* When the option, with automatic fluid fill function, is selected, the weight increases by 1 kg.

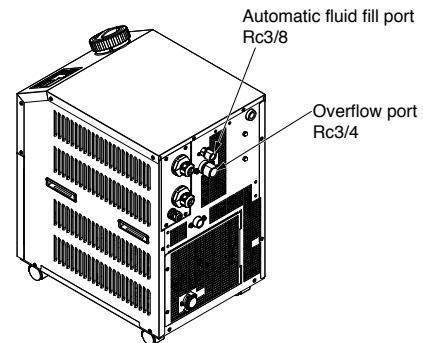

## **L** Option symbol

### Large Capacity Tank Specification

HRS  -A-20-L-R

● Large capacity tank specification

Tank capacity: 12 L

\* No change in external dimensions

\* When the large capacity tank specification is selected, the weight increases by 1 kg.

# HRS-R Series Options

## **T** Option symbol High-Pressure Pump Mounted

HRS  -A-20-T-R

● High-pressure pump mounted

Possible to choose a high-pressure pump in accordance with user's piping resistance.  
Cooling capacity will decrease by heat generated in the pump.

Applicable model		HRS018/030-A <input type="checkbox"/> -20- <input type="checkbox"/> T-R	
Pump	Rated flow (50/60 Hz)*1,*2	L/min	10 (0.35 MPa)/14 (0.35 MPa)
	Maximum flow rate (50/60 Hz)	L/min	17/20
	Maximum pump head (50/60 Hz)	m	70
	Output	W	610
Recommended earth leakage breaker capacity		A	15
Cooling capacity*3		W	The cooling capacity reduces about 300 W from the value in the catalog. (due to an increase in the heat generation of the pump)

\*1 The capacity at the thermo-chiller outlet when the circulating fluid temperature is 20°C.

\*2 Required minimum flow rate for maintaining the cooling capacity or temperature stability

\*3 Cooling capacity will decrease as pump power increases.

\*4 When the option, high-pressure pump mounted, is selected, the weight increases by 7 kg.

\* No change in external dimensions

## Pump Capacity

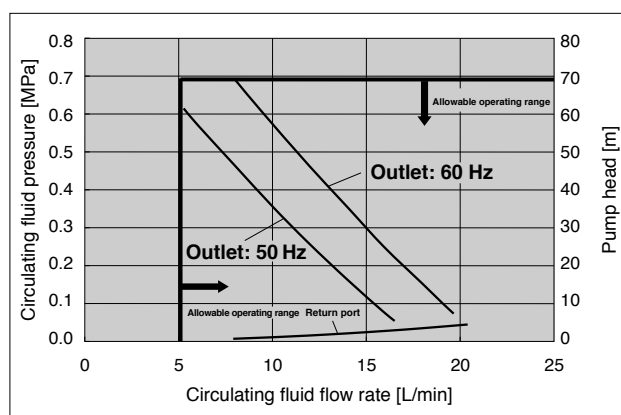

## ⚠ Caution

### Mechanical Seal Pump

The pump used for the option T of the thermo-chiller HRS018/030-R uses a mechanical seal with the fixed ring and rotary ring used for the shaft seal part. If foreign matter enter the gap between the seals, this may cause a trouble such as leakage from the seal part or pump lock. Therefore, it is strongly recommended to install the particle filter in the return piping of the chiller.

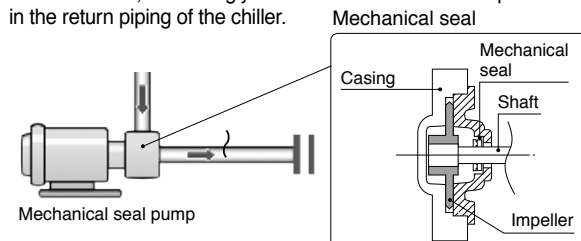

## **V** Option symbol Stainless Steel Panel Specification

HRS  -A-20-V-R

● Stainless steel panel specification

Exterior panel material is stainless steel (hairline finish).

\* No change in external dimensions

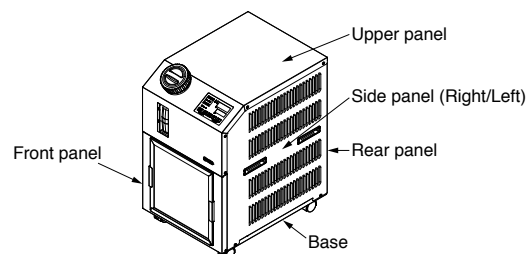

## **W** Option symbol SI Unit Only

HRS  -A-20-W-R

● SI unit only

The circulating fluid temperature and pressure are displayed in SI units [MPa/°C] only.

If this option is not selected, a product with a unit selection function will be provided by default.

\* No change in external dimensions

# HRS-R Series Optional Accessories

## ① Anti-Quake Bracket

This bracket can be used to reduce product damage in the case of an earthquake. An anchor bolt (M8) suitable for the flooring material should be prepared separately by the user. (Anti-quake bracket thickness: 1.6 mm)

[mm]			
Part no. (per unit)	Applicable model	A	B
HRS-TK001	HRS018-A-20-□-R	555	(590)
	HRS030-A-20-□-R		
HRS-TK002	HRS050-A-20-□-R	664	(698)

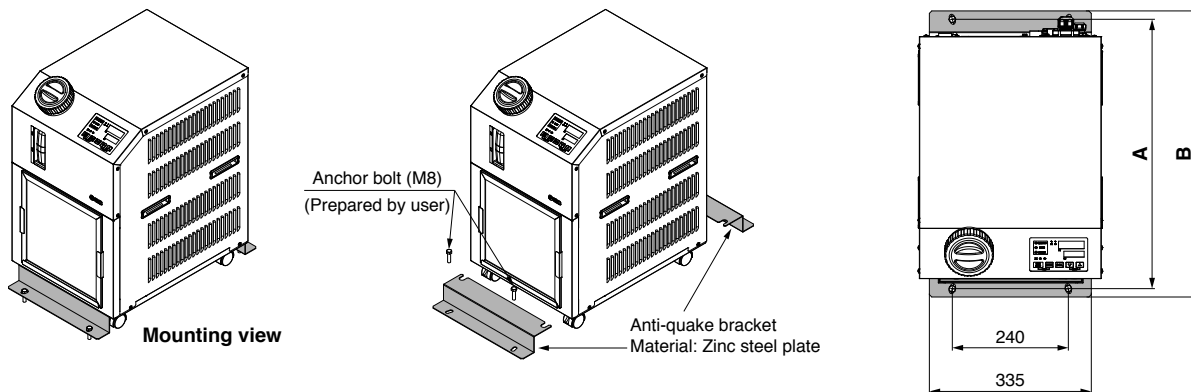

## ② Piping Conversion Fitting

### ■ Conversion fitting for circulating fluid + Conversion fitting for drain outlet

#### HRS018-A-20-□-R, HRS030-A-20-□-R

This fitting changes the port size for circulating fluid from Rc1/2 to G1/2 or NPT1/2, and for drain from Rc3/8 to G3/8 or NPT3/8. It is not necessary to purchase this when pipe thread type F or N is selected in "How to Order" since it is included in the product.

Part no.	Applicable model
HRS-EP001	HRS018-A-20-□-R HRS030-A-20-□-R
HRS-EP002	

When the options, with automatic fluid fill function "-J", or high-pressure pump mounted "-T" are selected, purchase ③ piping conversion fitting (for option), too.

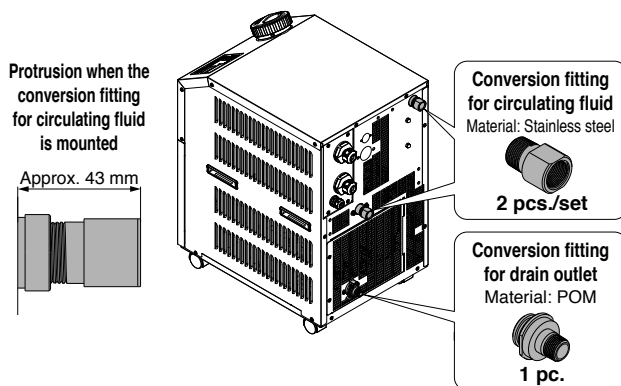

#### HRS050-A-20-□-R

This fitting changes the port size for circulating fluid from Rc1/2 to G1/2 or NPT1/2, and for drain from Rc1/4 to G1/4 or NPT1/4. It is not necessary to purchase this when pipe thread type F or N is selected in "How to Order" since it is included in the product.

Part no.	Applicable model
HRS-EP009	HRS050-A-20-□-R
HRS-EP010	

When the option, with automatic fluid fill function "-J", is selected, purchase ③ piping conversion fitting (for option), too.

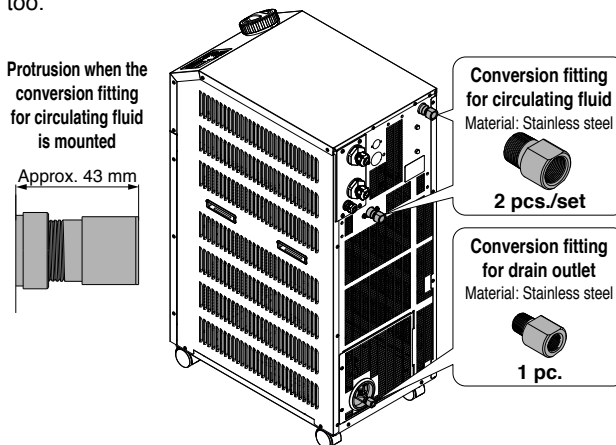

# HRS-R Series Optional Accessories

## ③ Piping Conversion Fitting (For Option)

### ■ Conversion fitting for automatic fluid fill port

This fitting changes the port size for the option, with automatic fluid fill function “-J” from Rc3/8, Rc3/4 to G3/8, G3/4 or NPT3/8, NPT3/4.

It is not necessary to purchase this when pipe thread type F or N is selected in “How to Order” since it is included in the product.

	Part no.	Applicable model
<b>HRS-EP005</b>	G thread conversion fitting set	HRS018-A-20-J-R HRS030-A-20-J-R HRS050-A-20-J-R
<b>HRS-EP006</b>	NPT thread conversion fitting set	

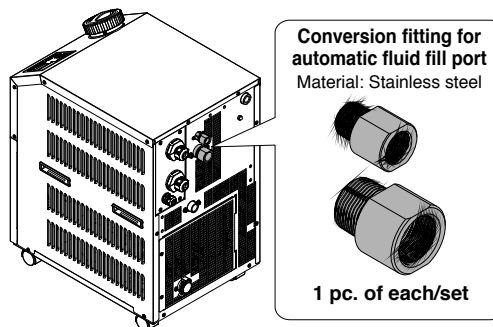

### ■ Conversion fitting for drain outlet

This fitting changes the port size for drain outlet for the option, high-pressure pump mounted “-T” from Rc1/4 to G1/4 or NPT1/4.

It is not necessary to purchase this when pipe thread type F or N is selected in “How to Order” since it is included in the product.

	Part no.	Applicable model
<b>HRS-EP007</b>	G thread conversion fitting	HRS018-A-20-T-R HRS030-A-20-T-R HRS050-A-20-R*1
<b>HRS-EP008</b>	NPT thread conversion fitting	

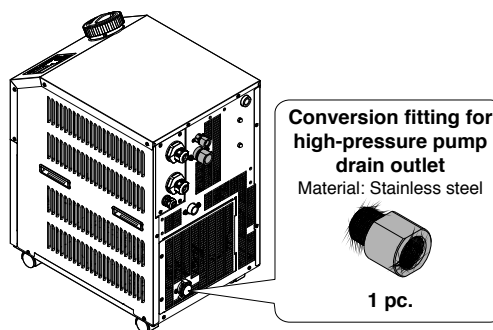

\*1 It is not necessary to purchase this when you purchase the HRS-EP009 to 010 since it is included in the product.

## ④ Concentration Meter

This meter can be used to control the concentration of ethylene glycol aqueous solution regularly.

Part no.	Applicable model
<b>HRZ-BR002</b>	HRS018-A-20-□-R HRS030-A-20-□-R HRS050-A-20-□-R

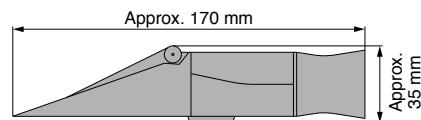

# HRS-R Series Optional Accessories

## ⑤ Bypass Piping Set

When the circulating fluid goes below the rated flow (7 L/min for the HRS018/030-R and 23/28 L/min for the HRS050-R), cooling capacity will be reduced and the temperature stability will be badly affected. In such a case, use the bypass piping set.

Part no.	Applicable model
<b>HRS-BP001</b>	HRS018-A-20-□-R HRS030-A-20-□-R

### Parts List

No.	Description	Fluid contact material	Qty.
①	Bypass tube (Part no.: TL0806)	PFA	1 (Approx. 700 mm)
②	Outlet piping (With ball valve)	Stainless steel	1
③	Return port piping	Stainless steel	1
④	Nipple (Size: 1/2)	Stainless steel	2

Part no.	Applicable model
<b>HRS-BP004</b>	HRS050-A-20-□-R

### Parts List

No.	Description	Fluid contact material	Qty.
①	Hose	PVC	1 (Approx. 700 mm)
②	Outlet piping (With ball valve)	Stainless steel	1
③	Return port piping	Stainless steel	1
④	Nipple (Size: 1/2)	Stainless steel	2
⑤	Hose band	—	2

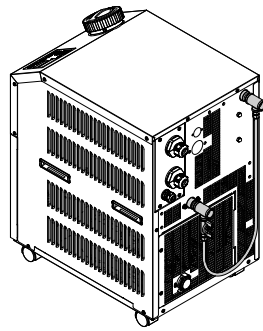

\* To be mounted by the user

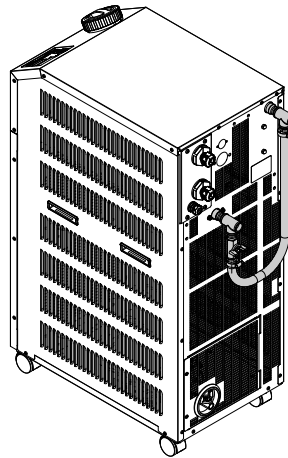
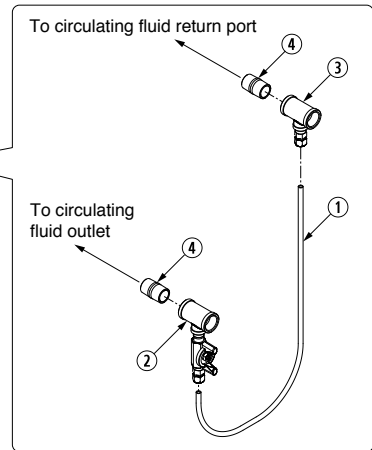

\* To be mounted by the user

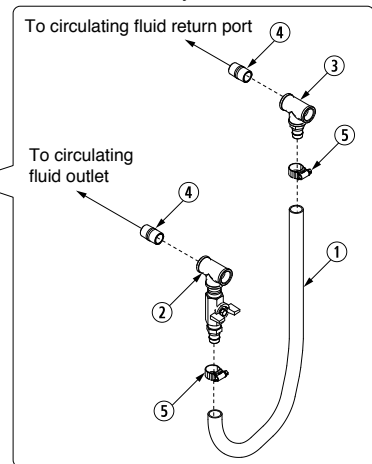

# HRS-R Series Optional Accessories

## ⑥ Particle Filter Set

This set can be used to remove foreign matter from the circulating fluid.

HRS-PF001-**W075**-**H**

PF002  
PF003  
PF004

### ● Filtration

Symbol	Nominal filtration accuracy [ $\mu\text{m}$ ]	Element part no. for PF001/PF003 (individual part)	Element part no. for PF002/PF004 (individual part)
Nil	Without element	—	—
W005	5	EJ202S-005X11	EJ302S-005X11
W075	75	EJ202S-075X11	EJ302S-075X11

### ● Accessory

Symbol	Accessory
Nil	None
H	With handle

### ■ For circulating fluid outlet [Used to protect user's equipment]

Part no.	Applicable model
<b>HRS-PF001</b> (Element length L = 125 mm)	HRS018-A-20-□-R HRS030-A-20-□-R HRS050-A-20-□-R
<b>HRS-PF002</b> (Element length L = 250 mm)	HRS050-A-20-□-R

#### Mounting view

The following reference drawing shows the HRS-PF001 mounted on the HRS018. For details, refer to the dimensions or the Operation Manual.

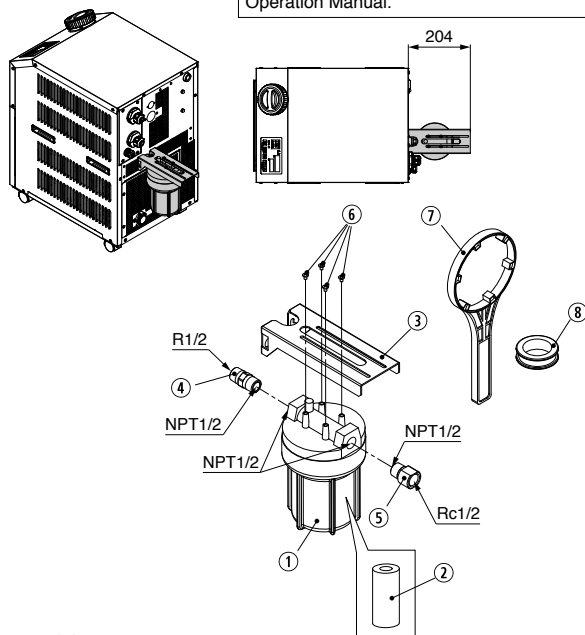

### ■ For circulating fluid return port [Used to protect thermo-chiller]

If foreign matter such as scales in the piping enter the circulating fluid, this may cause the pump to malfunction. Therefore, it is strongly recommended to install the particle filter set.

Part no.	Applicable model
<b>HRS-PF003</b> (Element length L = 125 mm)	HRS018-A-20-□-R HRS030-A-20-□-R HRS050-A-20-□-R
<b>HRS-PF004</b> (Element length L = 250 mm)	HRS050-A-20-□-R

#### Mounting view

The following reference drawing shows the HRS-PF004 mounted on the HRS050-R. For details, refer to the dimensions or the Operation Manual.

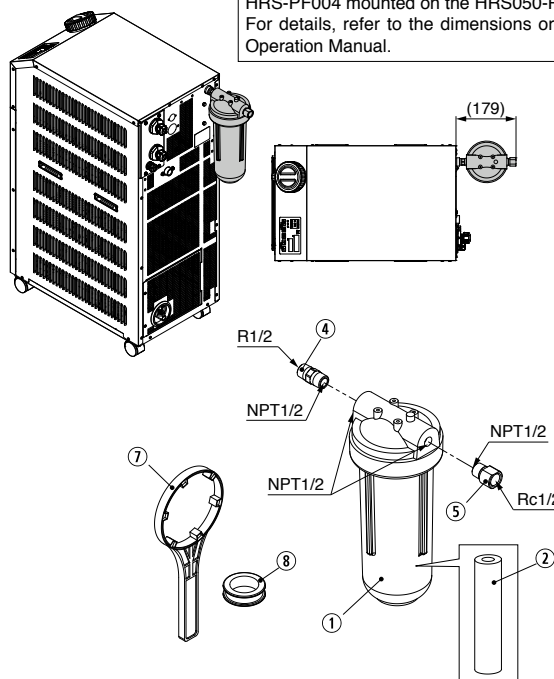

### Parts List

No.	Model	Description	Fluid contact material	Qty.	Note
①	—	Body	PP	1	—
②	EJ202S-005X11	Element (Length L = 125 mm)	PP/PE	1	For HRS-PF001/003
	EJ202S-075X11			1	
	EJ302S-005X11	Element (Length L = 250 mm)		1	For HRS-PF002/004
	EJ302S-075X11			1	
③	—	Particle filter bracket	—	1	For HRS-PF001/002
④	—	Nipple	Stainless steel	1	Conversion from R to NPT
⑤	—	Extension piece	Stainless steel	1	Conversion from NPT to Rc
⑥	—	Tapping screw	—	4	—
⑦	—	Handle	—	1	When -H is selected
⑧	—	Sealant tape	PTFE	1	—

# HRS-R Series Optional Accessories

## ⑦ Dustproof Filter

A disposable dustproof filter is mounted on the front panel.

Part no.	Applicable model
<b>HRS-FL003</b>	HRS018-A-20-□-R
	HRS030-A-20-□-R
	HRS050-A-20-□-R

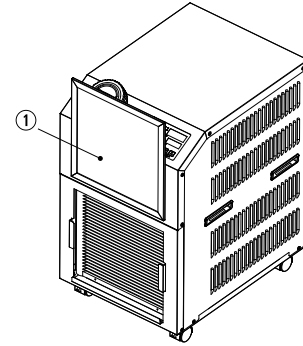

### Parts List

No.	Description	Part no.	Note
①	Dustproof filter	HRS-FL003	Size: 295 x 295 (5 filters per set)

## ⑧ Separately-Installed Power Transformer

### Specifications

Part no.	Applicable model	Volume	Type	Inlet voltage		Outlet voltage	
				50 Hz	60 Hz	50 Hz	60 Hz
<b>IDF-TR2000-9</b>	HRS018-A-20 HRS030-A-20	2 kVA	Single-phase	—	240 VAC	—	200, 220 VAC
<b>IDF-TR2000-10</b>				380, 400, 415 VAC	380 to 400, 400 to 415, 415 to 440 VAC	200 VAC	
<b>IDF-TR2000-11</b>				440, 460 VAC	440 to 460, 460 to 500 VAC		

\* For the HRS050 model: To be prepared by the user

### IDF-TR2000-9

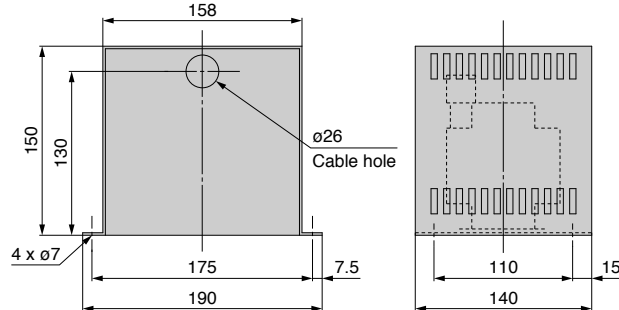

### IDF-TR2000-10, 11

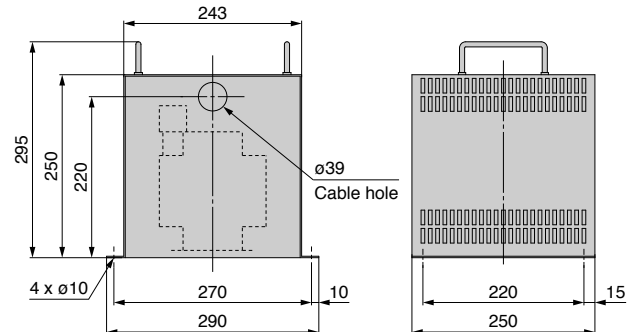

## ⑨ Filter for Circulating Fluid Fill Port

Prevents foreign matter from entering the tank when supplying the circulating fluid. Can be used just by fitting into the circulating fluid fill port.

### Filter for circulating fluid fill port HRS-PF007

Material	Stainless steel 304, Stainless steel 316
Mesh size	200

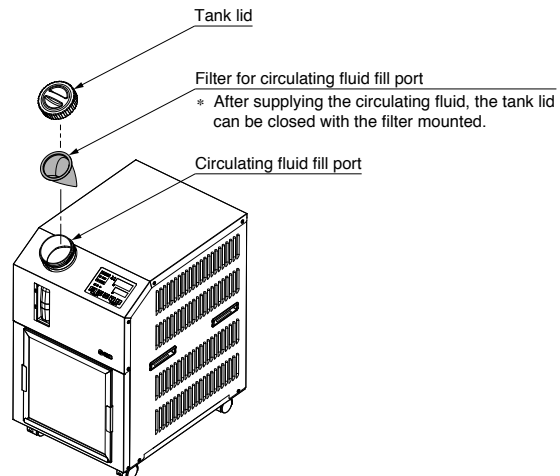



# HRS-R Series Cool Capacity Calculation

## Required Cooling Capacity Calculation

### Example 1: When the heat generation amount in the user's equipment is known.

The heat generation amount can be determined based on the power consumption or output of the heat generating area – i.e. the area requiring cooling – within the user's equipment.\*1

- ① Derive the heat generation amount from the power consumption.

Power consumption P: 1000 [W]

$$Q = P = 1000 \text{ [W]}$$

Cooling capacity = Considering a safety factor of 20%,

$$1000 \text{ [W]} \times 1.2 = \mathbf{1200 \text{ [W]}}$$

- ② Derive the heat generation amount from the power supply output.

Power supply output VI: 1.0 [kVA]

$$Q = P = V \times I \times \text{Power factor}$$

In this example, using a power factor of 0.85:

$$= 1.0 \text{ [kVA]} \times 0.85 = 0.85 \text{ [kW]} = 850 \text{ [W]}$$

Cooling capacity = Considering a safety factor of 20%,

$$850 \text{ [W]} \times 1.2 = \mathbf{1020 \text{ [W]}}$$

- ③ Derive the heat generation amount from the output.

Output (shaft power, etc.) W: 800 [W]

$$Q = P = \frac{W}{\text{Efficiency}}$$

In this example, using an efficiency of 0.7:

$$= \frac{800}{0.7} = 1143 \text{ [W]}$$

Cooling capacity = Considering a safety factor of 20%,

$$1143 \text{ [W]} \times 1.2 = \mathbf{1372 \text{ [W]}}$$

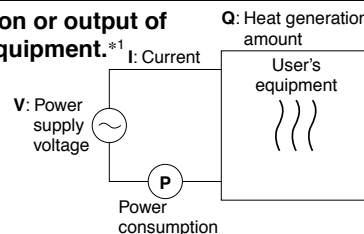

\*1 The examples above calculate the heat generation amount based on the power consumption. The actual heat generation amount may differ due to the structure of the user's equipment. Be sure to check it carefully.

### Example 2: When the heat generation amount in the user's equipment is not known.

Obtain the temperature difference between inlet and outlet by circulating the circulating fluid inside the user's equipment.

Heat generation amount by user's equipment Q : Unknown [W] (J/s)  
 Circulating fluid : Tap water\*1  
 Circulating fluid mass flow rate  $q_m$  : ( $= \rho \times q_v \div 60$ ) [kg/s]  
 Circulating fluid density  $\rho$  : 1 [kg/dm<sup>3</sup>]  
 Circulating fluid (volume) flow rate  $q_v$  : 10 [dm<sup>3</sup>/min]  
 Circulating fluid specific heat C :  $4.2 \times 10^3$  [J/(kg·K)]  
 Circulating fluid outlet temperature T<sub>1</sub> : 293 [K] (20 [°C])  
 Circulating fluid return temperature T<sub>2</sub> : 295 [K] (22 [°C])  
 Circulating fluid temperature difference  $\Delta T$  : 2.0 [K] ( $= T_2 - T_1$ )  
 Conversion factor: minutes to seconds (SI units) : 60 [s/min]

\*1 Refer to page 25 for the typical physical property value of tap water or other circulating fluids.

$$Q = q_m \times C \times (T_2 - T_1)$$

$$= \frac{\rho \times q_v \times C \times \Delta T}{60} = \frac{1 \times 10 \times 4.2 \times 10^3 \times 2.0}{60}$$

$$= 1400 \text{ [J/s]} \approx 1400 \text{ [W]}$$

Cooling capacity = Considering a safety factor of 20%,

$$1400 \text{ [W]} \times 1.2 = \mathbf{1680 \text{ [W]}}$$

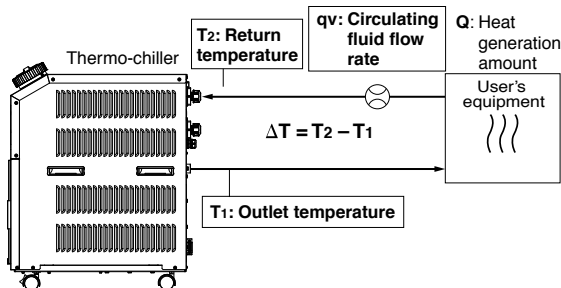

#### Example of conventional units (Reference)

Heat generation amount by user's equipment Q : Unknown [cal/h] → [W]  
 Circulating fluid : Tap water\*1  
 Circulating fluid weight flow rate  $q_m$  : ( $= \rho \times q_v \times 60$ ) [kgf/h]  
 Circulating fluid weight volume ratio  $\gamma$  : 1 [kgf/L]  
 Circulating fluid (volume) flow rate  $q_v$  : 10 [L/min]  
 Circulating fluid specific heat C :  $1.0 \times 10^3$  [cal/(kgf·°C)]  
 Circulating fluid outlet temperature T<sub>1</sub> : 20 [°C]  
 Circulating fluid return temperature T<sub>2</sub> : 22 [°C]  
 Circulating fluid temperature difference  $\Delta T$  : 2.0 [°C] ( $= T_2 - T_1$ )  
 Conversion factor: hours to minutes : 60 [min/h]  
 Conversion factor: kcal/h to kW : 860 [(cal/h)/W]

$$Q = \frac{q_m \times C \times (T_2 - T_1)}{860}$$

$$= \frac{\gamma \times q_v \times 60 \times C \times \Delta T}{860}$$

$$= \frac{1 \times 10 \times 60 \times 1.0 \times 10^3 \times 2.0}{860}$$

$$= \frac{1200000 \text{ [cal/h]}}{860}$$

$$\approx 1400 \text{ [W]}$$

Cooling capacity = Considering a safety factor of 20%,

$$1400 \text{ [W]} \times 1.2 = \mathbf{1680 \text{ [W]}}$$

# HRS-R Series Cool Capacity Calculation

## Required Cooling Capacity Calculation

### Example 3: When there is no heat generation, and when cooling the object below a certain temperature and period of time.

Heat quantity by cooled substance (per unit time) **Q**: Unknown [W] [(J/s)]  
 Cooled substance : Water  
 Cooled substance mass **m** : (=  $\rho \times V$ ) [kg]  
 Cooled substance density  $\rho$  : 1 [kg/L]  
 Cooled substance total volume **V** : 20 [dm<sup>3</sup>]  
 Cooled substance specific heat **C** : 4.2 x 10<sup>3</sup> [J/(kg·K)]  
 Cooled substance temperature when cooling begins **T<sub>0</sub>**: 305 [K] (32 [°C])  
 Cooled substance temperature after t hour **T<sub>t</sub>** : 293 [K] (20 [°C])  
 Cooling temperature difference  $\Delta T$  : 12 [K] (=  $T_0 - T_t$ )  
 Cooling time  $\Delta t$  : 900 [s] (= 15 [min])

\* Refer to the following for the typical physical property values by circulating fluid.

$$Q = \frac{m \times C \times (T_0 - T_t)}{\Delta t} = \frac{\rho \times V \times C \times \Delta T}{\Delta t}$$

$$= \frac{1 \times 20 \times 4.2 \times 10^3 \times 12}{900} = 1120 \text{ [J/s]} \approx 1120 \text{ [W]}$$

Cooling capacity = Considering a safety factor of 20%,

$$1120 \text{ [W]} \times 1.2 = 1344 \text{ [W]}$$

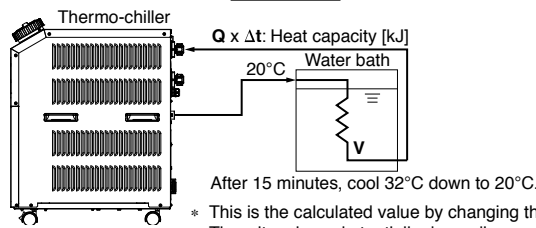

\* This is the calculated value by changing the fluid temperature only. Thus, it varies substantially depending on the water bath or piping shape.

### Example of conventional units (Reference)

Heat quantity by cooled substance (per unit time) **Q**: Unknown [cal/h] → [W]  
 Cooled substance : Water  
 Cooled substance weight **m** : (=  $\rho \times V$ ) [kgf]  
 Cooled substance weight volume ratio  $\gamma$  : 1 [kgf/L]  
 Cooled substance total volume **V** : 20 [L]  
 Cooled substance specific heat **C** : 1.0 x 10<sup>5</sup> [cal/(kgf·°C)]  
 Cooled substance temperature when cooling begins **T<sub>0</sub>** : 32 [°C]  
 Cooled substance temperature after t hour **T<sub>t</sub>**: 20 [°C]  
 Cooling temperature difference  $\Delta T$  : 12 [°C] (=  $T_0 - T_t$ )  
 Cooling time  $\Delta t$  : 15 [min]  
 Conversion factor: hours to minutes : 60 [min/h]  
 Conversion factor: kcal/h to kW : 860 [(cal/h)/W]

$$Q = \frac{m \times C \times (T_0 - T_t)}{\Delta t \times 860} = \frac{\gamma \times V \times 60 \times C \times \Delta T}{\Delta t \times 860}$$

$$= \frac{1 \times 20 \times 60 \times 1.0 \times 10^5 \times 12}{15 \times 860}$$

$$\approx 1120 \text{ [W]}$$

Cooling capacity = Considering a safety factor of 20%,

$$1120 \text{ [W]} \times 1.2 = 1344 \text{ [W]}$$

## Precautions on Cooling Capacity Calculation

### 1. Heating capacity

When the circulating fluid temperature is set above room temperature, it needs to be heated by the thermo-chiller. The heating capacity depends on the circulating fluid temperature. Consider the radiation rate and heat capacity of the user's equipment and check beforehand if the required heating capacity is provided.

### 2. Pump capacity

#### <Circulating fluid flow rate>

Circulating fluid flow rate varies depending on the circulating fluid discharge pressure. Consider the installation height difference between the thermo-chiller and the user's equipment, and the piping resistance such as circulating fluid pipings, or piping size, or piping curves in the machine. Check beforehand if the required flow is achieved, using the pump capacity curves.

#### <Circulating fluid discharge pressure>

Circulating fluid discharge pressure has the possibility to increase up to the maximum pressure in the pump capacity curves. Check beforehand if the circulating fluid pipings or circulating fluid circuit of the user's equipment are fully durable against this pressure.

## Circulating Fluid Typical Physical Property Values

### 1. This catalog uses the following values for density and specific heat in calculating the required cooling capacity.

Density  $\rho$ : 1 [kg/L] (or, using conventional units, weight volume ratio  $\gamma = 1$  [kgf/L])  
 Specific heat **C**: 4.19 x 10<sup>3</sup> [J/(kg·K)] (or, using conventional units, 1 x 10<sup>5</sup> [cal/(kgf·°C)])

### 2. Values for density and specific heat change slightly according to temperature shown below. Use this as a reference.

#### Water

Physical property value Temperature	Density $\rho$ [kg/L]	Specific heat C [J/(kg·K)]	Conventional units	
			Weight volume ratio $\gamma$ [kgf/L]	Specific heat C [cal/(kgf·°C)]
5°C	1.00	4.2 x 10 <sup>3</sup>	1.00	1 x 10 <sup>5</sup>
10°C	1.00	4.19 x 10 <sup>3</sup>	1.00	1 x 10 <sup>5</sup>
15°C	1.00	4.19 x 10 <sup>3</sup>	1.00	1 x 10 <sup>5</sup>
20°C	1.00	4.18 x 10 <sup>3</sup>	1.00	1 x 10 <sup>5</sup>
25°C	1.00	4.18 x 10 <sup>3</sup>	1.00	1 x 10 <sup>5</sup>
30°C	1.00	4.18 x 10 <sup>3</sup>	1.00	1 x 10 <sup>5</sup>
35°C	0.99	4.18 x 10 <sup>3</sup>	0.99	1 x 10 <sup>5</sup>
40°C	0.99	4.18 x 10 <sup>3</sup>	0.99	1 x 10 <sup>5</sup>

#### 15% Ethylene Glycol Aqueous Solution

Physical property value Temperature	Density $\rho$ [kg/L]	Specific heat C [J/(kg·K)]	Conventional units	
			Weight volume ratio $\gamma$ [kgf/L]	Specific heat C [cal/(kgf·°C)]
5°C	1.02	3.91 x 10 <sup>3</sup>	1.02	0.93 x 10 <sup>5</sup>
10°C	1.02	3.91 x 10 <sup>3</sup>	1.02	0.93 x 10 <sup>5</sup>
15°C	1.02	3.91 x 10 <sup>3</sup>	1.02	0.93 x 10 <sup>5</sup>
20°C	1.01	3.91 x 10 <sup>3</sup>	1.01	0.93 x 10 <sup>5</sup>
25°C	1.01	3.91 x 10 <sup>3</sup>	1.01	0.93 x 10 <sup>5</sup>
30°C	1.01	3.91 x 10 <sup>3</sup>	1.01	0.94 x 10 <sup>5</sup>
35°C	1.01	3.91 x 10 <sup>3</sup>	1.01	0.94 x 10 <sup>5</sup>
40°C	1.01	3.92 x 10 <sup>3</sup>	1.01	0.94 x 10 <sup>5</sup>

\* Shown above are reference values. Contact circulating fluid supplier for details.



## HRS-R Series

# Specific Product Precautions 1

Be sure to read this before handling the products. Refer to the back cover for safety instructions. For temperature control equipment precautions, refer to the “Handling Precautions for SMC Products” and the “Operation Manual” on SMC website.

### Design

#### ⚠ Warning

##### 1. This catalog shows the specifications of a single unit.

- 1) Check the specifications of the single unit (contents of this catalog) and thoroughly consider the adaptability between the user's system and this unit.
- 2) Although a protection circuit as a single unit is installed, prepare a drain pan, water leakage sensor, discharge air facility, and emergency stop equipment, depending on the user's operating conditions. Also, the user is requested to carry out a safety design for the whole system.

##### 2. When attempting to cool areas that are open to the atmosphere (tanks, pipes), plan your piping system accordingly.

When cooling open-air external tanks, arrange the piping so that there are coil pipes for cooling inside the tanks and to carry back the entire flow volume of circulating fluid that is released.

##### 3. Use non-corrosive material for circulating fluid contact parts.

The recommended circulating fluid is tap water or 15% ethylene glycol aqueous solution. Using corrosive materials such as aluminum or iron for fluid contact parts such as piping may cause clogging or leakage in the circulating fluid circuit. Therefore, take sufficient care when selecting fluid contact part materials such as piping.

##### 4. Design the piping so that no foreign matter enters the chiller.

If foreign matter, such as scales in the piping, enters the circulating fluid, this may cause the pump to malfunction.

### Selection

#### ⚠ Warning

##### 1. Model selection

When selecting a thermo-chiller model, the amount of heat generation from the user's equipment must be known. Obtain this value, referring to “Cooling Capacity Calculation” on pages 24 and 25 before selecting a model.

### Handling

#### ⚠ Warning

##### 1. Thoroughly read the operation manual.

Read the operation manual completely before operation, and keep the manual where it can be referred to as necessary.

### Transportation/Carriage/Movement

#### ⚠ Warning

##### 1. This product is heavy. Pay attention to safety and the position of the product when it is transported, carried, and moved.

##### 2. Read the operation manual carefully before moving the product after unpacking.

#### ⚠ Caution

##### 1. Never put the product down on its side as this may cause failure.

The product will be delivered in the packaging shown below.

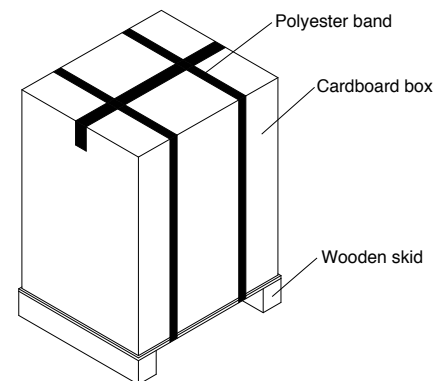

Model	Weight [kg]*1	Dimensions [mm]
HRS018-A-20-□-R HRS030-A-20-□-R	54	Height 790 x Width 470 x Depth 580
When option B or T is included in the model above (HRS018/030)	See *1 below.	Height 790 x Width 470 x Depth 780
HRS050-A-20-□-R	80	Height 1160 x Width 450 x Depth 670
When option B is included in the model above (HRS050)	See *1 below.	Height 1200 x Width 515 x Depth 995

\*1 For models with an option, the weight increases as shown below.

Option symbol	Description	Additional weight	
		HRS018/030	HRS050
-B	With earth leakage breaker	+6 kg	+7 kg
-J	With automatic fluid fill function	+1 kg	
-L	Large capacity tank specification	+1 kg	
-T	High-pressure pump mounted	+11 kg	—
-V	Stainless steel panel specification	No additional weight	
-W	SI unit only	No additional weight	



## HRS-R Series

# Specific Product Precautions 2

Be sure to read this before handling the products. Refer to the back cover for safety instructions. For temperature control equipment precautions, refer to the "Handling Precautions for SMC Products" and the "Operation Manual" on SMC website.

### Operating Environment/Storage Environment

#### Warning

1. Do not use in the following environment as it will lead to a breakdown.
    - 1) Outdoors
    - 2) In locations where water, water vapor, salt water, and oil may splash on the product
    - 3) In locations where there is a large amount of dust and particles
    - 4) In locations where corrosive gases, organic solvents, chemical fluids, or flammable gases are present (This product is not explosion proof.)
    - 5) In locations where the ambient temperature exceeds the limits as mentioned below
      - During transportation/storage: 0 to 50°C (But as long as water or circulating fluid are not left inside the pipings)
      - During operation: 5 to 45°C
    - 6) In locations where the ambient humidity is out of the following range or where condensation occurs
      - During transportation/storage: 15 to 85%
      - During operation: 30 to 70%
    - 7) In locations which receive direct sunlight or radiated heat
    - 8) In locations where there is a heat source nearby and the ventilation is poor
    - 9) In locations where temperature substantially changes
    - 10) In locations where strong magnetic noise occurs (In locations where strong electric fields, strong magnetic fields, and surge voltage occur)
    - 11) In locations where static electricity occurs, or conditions which make the product discharge static electricity
    - 12) In locations where high frequency occurs
    - 13) In locations where damage is likely to occur due to lightning
    - 14) In locations at an altitude of 3000 m or higher (Except during storage and transportation)
      - \* For altitudes of 1000 m or higher
 

Because of lower air density, the heat radiation efficiencies of the devices in the product will be lower in the location at an altitude of 1000 m or higher. Therefore, the maximum ambient temperature to use and the cooling capacity will lower according to the descriptions in the table below.

Select the thermo-chiller considering the descriptions.

        - ① Upper limit of ambient temperature: Use the product in ambient temperature of the described value or lower at each altitude.
        - ② Cooling capacity coefficient: The product's cooling capacity will lower to one that multiplied by the described value at each altitude.
- | Altitude [m]     | ① Upper limit of ambient temperature [°C] | ② Cooling capacity coefficient |
|------------------|---|--------------------------------|
| Less than 1000 m | 45  | 1.00                           |
| Less than 1500 m | 42  | 0.85                           |
| Less than 2000 m | 38  | 0.80                           |
| Less than 2500 m | 35  | 0.75                           |
| Less than 3000 m | 32  | 0.70                           |
- 15) In locations where strong impacts or vibrations occur
  - 16) In locations where a massive force strong enough to deform the product is applied or the weight from a heavy object is applied
  - 17) In locations where there is not sufficient space for maintenance
  - 18) Environment in which the product is exposed to particles or water splash that is higher than IP54

### Operating Environment/Storage Environment

#### Warning

2. Install in an environment where the unit will not come into direct contact with rain or snow.
  - These models are for indoor use only.
  - Do not install outdoors where rain or snow may fall on them.
3. Conduct ventilation and cooling to discharge heat.
  - The heat which is cooled down through air-cooled condenser is discharged.
  - When using in a room which is shut tightly, ambient temperature will exceed the specification range stipulated in this catalog, which will activate the safety detector and stop the operation.
  - In order to avoid this situation, discharge the heat outside of a room by ventilation or cooling facilities.
4. The product is not designed for clean room usage. It generates particles internally.

### Mounting/Installation

#### Warning

1. Do not use the product outdoors.
2. Do not place heavy objects on top of this product, or step on it.
  - The external panel can be deformed and danger can result.

#### Caution

1. Install on a rigid floor which can withstand this product's weight.
2. When installing without the casters, use the adjuster feet, etc. to raise the chiller to the following heights or more.
  - This product cannot be directly installed on the floor as some screws come out from the bottom of the product.
  - HRS018/030-R 10 mm
  - HRS050-R 15 mm



# HRS-R Series Specific Product Precautions 3

Be sure to read this before handling the products. Refer to the back cover for safety instructions. For temperature control equipment precautions, refer to the "Handling Precautions for SMC Products" and the "Operation Manual" on SMC website.

## Mounting/Installation

### ⚠ Caution

3. Refer to the Operation Manual for this product, and secure an installation space that is necessary for the maintenance and ventilation.

1. The air-cooled type product exhausts heat using the fan that is mounted to the product. If the product is operated with insufficient ventilation, ambient temperature may exceed 45°C, and this will affect the performance and life of the product. To prevent this ensure that suitable ventilation is available (see below).
2. For installation indoors, ventilation ports and a ventilation fan should be equipped as needed.

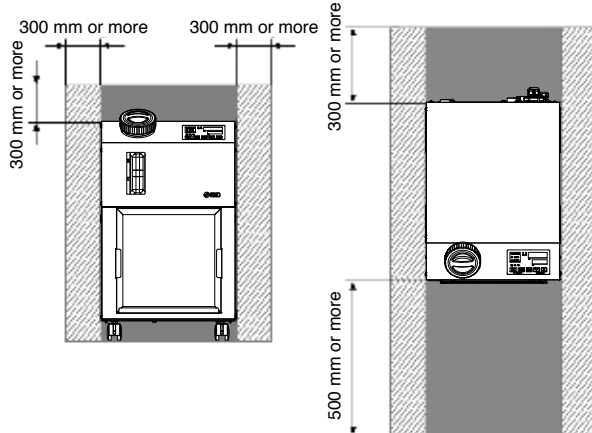

### <Heat radiation amount/Required ventilation rate>

Model	Heat radiation amount [kW]	Required ventilation rate [m <sup>3</sup> /min]	
		Differential temp. of 3°C between inside and outside of installation area	Differential temp. of 6°C between inside and outside of installation area
HRS018-R	Approx. 4	70	40
HRS030-R	Approx. 6	100	60
HRS050-R	Approx. 10	140	70

## Piping

### ⚠ Caution

1. Regarding the circulating fluid pipings, consider carefully the suitability for shutoff pressure, temperature and circulating fluid.

If the operating performance is not sufficient, the pipings may burst during operation. Also, the use of corrosive materials such as aluminum or iron for fluid contact parts, such as piping, may not only lead to clogging or leakage in the circulating fluid circuit but also refrigerant leakage and other unexpected problems. Provide protection against corrosion when you use the product.

2. Select the piping port size which can exceed the rated flow.

For the rated flow, refer to the pump capacity table.

3. When tightening at the circulating fluid inlet and outlet, drain port or overflow port of this product, use a pipe wrench to clamp the connection ports.

4. For the circulating fluid piping connection, install a drain pan and wastewater collection pit just in case the circulating fluid may leak.

5. This product series is constant-temperature fluid circulating machines with built-in tanks.

Do not install equipment on your system side such as pumps that forcibly return the circulating fluid to the unit. Also, if you attach an external tank that is open to the air, it may become impossible to circulate the circulating fluid. Proceed with caution.

## Electrical Wiring

### ⚠ Warning

1. Grounding should never be connected to a water line, gas line or lightning rod.

### ⚠ Caution

1. Communication cable should be prepared by the user.

2. Provide a stable power supply which is not affected by surge or distortion.

If the voltage increase ratio (dV/dt) at the zero cross should exceed 40 V/200 μsec., it may result in malfunction.

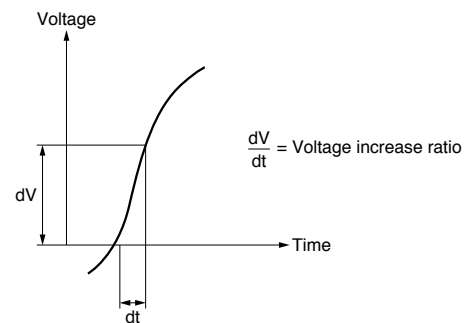



# HRS-R Series Specific Product Precautions 4

Be sure to read this before handling the products. Refer to the back cover for safety instructions. For temperature control equipment precautions, refer to the “Handling Precautions for SMC Products” and the “Operation Manual” on SMC website.

## Circulating Fluid

### ⚠ Caution

1. Avoid oil or other foreign matter entering the circulating fluid.
2. When water is used as a circulating fluid, use tap water that conforms to the appropriate water quality standards.

Use tap water that conforms to the standards shown below (including water used for dilution of ethylene glycol aqueous solution).

#### Tap Water (as a Circulating Fluid) Quality Standards

The Japan Refrigeration and Air Conditioning Industry Association  
JRA GL-02-1994 “Cooling water system – Circulation type – Make-up water”

	Item	Unit	Standard value	Influence	
				Corrosion	Scale generation
Standard item	pH (at 25°C)	—	6.0 to 8.0	○	○
	Electric conductivity (25°C)	[μS/cm]	100*1 to 300*1	○	○
	Chloride ion (Cl <sup>-</sup> )	[mg/L]	50 or less	○	
	Sulfuric acid ion (SO <sub>4</sub> <sup>2-</sup> )	[mg/L]	50 or less	○	
	Acid consumption amount (at pH4.8)	[mg/L]	50 or less		○
	Total hardness	[mg/L]	70 or less		○
Reference item	Calcium hardness (CaCO <sub>3</sub> )	[mg/L]	50 or less		○
	Ionic state silica (SiO <sub>2</sub> )	[mg/L]	30 or less		○
	Iron (Fe)	[mg/L]	0.3 or less	○	○
	Copper (Cu)	[mg/L]	0.1 or less	○	
	Sulfide ion (S <sub>2</sub> <sup>-</sup> )	[mg/L]	Should not be detected	○	
	Ammonium ion (NH <sub>4</sub> <sup>+</sup> )	[mg/L]	0.1 or less	○	
	Residual chlorine (Cl)	[mg/L]	0.3 or less	○	
Free carbon (CO <sub>2</sub> )	[mg/L]	4.0 or less	○		

\*1 In the case of [MΩ·cm], it will be 0.003 to 0.01.

- : Factors that have an effect on corrosion or scale generation
- Even if the water quality standards are met, complete prevention of corrosion is not guaranteed.

3. Use an ethylene glycol aqueous solution that does not contain additives such as preservatives.
4. When using ethylene glycol aqueous solution, maintain a maximum concentration of 15%.  
Overly high concentrations can cause a pump overload. Low concentrations, however, can lead to freezing when circulating fluid temperature is 10°C or lower and cause the thermo-chiller to break down.
5. A magnet pump or mechanical seal pump is used as the circulating pump for the circulating fluid.

It is particularly impossible to use liquid including metallic powders such as iron powder.

## Operation

### ⚠ Warning

#### 1. Confirmation before operation

- 1) The fluid level of a tank should be within the specified range of “HIGH” and “LOW.”  
When exceeding the specified level, the circulating fluid will overflow.
- 2) Remove the air.  
Conduct a trial operation, looking at the fluid level.  
Since the fluid level will go down when the air is removed from the user’s piping system, supply water once again when the fluid level is reduced. When there is no reduction in the fluid level, the job of removing the air is completed.  
Pump can be operated independently.

#### 2. Confirmation during operation

- Check the circulating fluid temperature.  
The operating temperature range of the circulating fluid is between 5 and 40°C.  
When the amount of heat generated from the user’s equipment is greater than the product’s capability, the circulating fluid temperature may exceed this range. Use caution regarding this matter.

#### 3. Emergency stop method

- When an abnormality is confirmed, stop the machine immediately. Be sure to shut off the breaker of the user’s power supply.

## Operation Restart Time/Operation and Suspension Frequency

### ⚠ Caution

1. Wait five minutes or more before restarting operation after it has been stopped. If the operation is restarted within five minutes, the protection circuit may activate and the operation may not start properly.
2. Operation and suspension frequency should not exceed 10 times per day. Frequently switching between operation and suspension may result in the malfunction of the refrigeration circuit.

## Protection Circuit

### ⚠ Caution

1. If operating in the below conditions, the protection circuit will activate and an operation may not be performed or will stop.
  - Power supply voltage is not within the rated voltage range of ±10%.
  - In case the water level inside the tank is reduced abnormally.
  - Circulating fluid temperature is too high.
  - Compared to the cooling capacity, the heat generation amount of the user’s equipment is too high.
  - Ambient temperature is too high. (45°C or more)
  - Refrigerant pressure is too high.
  - Ventilation grille is clogged with dust or dirt.



# HRS-R Series Specific Product Precautions 5

Be sure to read this before handling the products. Refer to the back cover for safety instructions. For temperature control equipment precautions, refer to the “Handling Precautions for SMC Products” and the “Operation Manual” on SMC website.

## Maintenance

### Caution

#### <Periodical inspection every one month>

##### 1. Clean the ventilation grille.

If the dustproof filter becomes clogged with dust or debris, a decline in cooling performance can result.

In order to avoid deforming or damaging the dustproof filter, clean it with a long-haired brush or air gun.

#### <Periodical inspection every three months>

##### 1. Inspect the circulating fluid.

1) When using tap water

- Replacement of tap water

Failure to replace the tap water can lead to the development of bacteria and algae. Replace it regularly according to your usage conditions.

- Tank cleaning

Consider whether dirt, slime, or foreign matter may be present in the circulating fluid inside the tank, and carry out regular cleanings of the tank.

2) When using ethylene glycol aqueous solution

Use a concentration meter to confirm that the concentration does not exceed 15%.

Dilute or add as needed to adjust the concentration.

#### <Periodical inspection during the winter season>

##### 1. Make water-removal arrangements beforehand.

If there is a risk of the circulating fluid freezing when the product is stopped, release the circulating fluid in advance.

##### 2. Consult a professional.

For additional methods to prevent freezing (such as commercially available tape heaters, etc.), consult a professional for advice.

### ■ Refrigerant with GWP reference

Refrigerant	Global warming potential (GWP)	
	Regulation (EU) No 517/2014 (Based on the IPCC AR4)	Revised Fluorocarbons Recovery and Destruction Law (Japanese law)
R134a	1,430	1,430
R404A	3,922	3,920
R407C	1,774	1,770
R410A	2,088	2,090

\* This product is hermetically sealed and contains fluorinated greenhouse gases (HFC). When this product is sold on the market in the EU after January 1, 2017, it needs to be compliant with the quota system of the F-Gas Regulation in the EU.

\* See specification table for refrigerant used in the product.

### ■ Trademark Information

Modbus® is a registered trademark of Schneider Electric, licensed to the Modbus Organization, Inc.

## Safety Instructions

These safety instructions are intended to prevent hazardous situations and/or equipment damage. These instructions indicate the level of potential hazard with the labels of “Caution,” “Warning” or “Danger.” They are all important notes for safety and must be followed in addition to International Standards (ISO/IEC)\*1), and other safety regulations.

 **Caution:** Caution indicates a hazard with a low level of risk which, if not avoided, could result in minor or moderate injury.

 **Warning:** Warning indicates a hazard with a medium level of risk which, if not avoided, could result in death or serious injury.

 **Danger:** Danger indicates a hazard with a high level of risk which, if not avoided, will result in death or serious injury.

\*1) ISO 4414: Pneumatic fluid power – General rules relating to systems.  
 ISO 4413: Hydraulic fluid power – General rules relating to systems.  
 IEC 60204-1: Safety of machinery – Electrical equipment of machines.  
 (Part 1: General requirements)  
 ISO 10218-1: Manipulating industrial robots – Safety.  
 etc.

### Warning

**1. The compatibility of the product is the responsibility of the person who designs the equipment or decides its specifications.**

Since the product specified here is used under various operating conditions, its compatibility with specific equipment must be decided by the person who designs the equipment or decides its specifications based on necessary analysis and test results. The expected performance and safety assurance of the equipment will be the responsibility of the person who has determined its compatibility with the product. This person should also continuously review all specifications of the product referring to its latest catalog information, with a view to giving due consideration to any possibility of equipment failure when configuring the equipment.

**2. Only personnel with appropriate training should operate machinery and equipment.**

The product specified here may become unsafe if handled incorrectly. The assembly, operation and maintenance of machines or equipment including our products must be performed by an operator who is appropriately trained and experienced.

**3. Do not service or attempt to remove product and machinery/equipment until safety is confirmed.**

1. The inspection and maintenance of machinery/equipment should only be performed after measures to prevent falling or runaway of the driven objects have been confirmed.
2. When the product is to be removed, confirm that the safety measures as mentioned above are implemented and the power from any appropriate source is cut, and read and understand the specific product precautions of all relevant products carefully.
3. Before machinery/equipment is restarted, take measures to prevent unexpected operation and malfunction.

**4. Contact SMC beforehand and take special consideration of safety measures if the product is to be used in any of the following conditions.**

1. Conditions and environments outside of the given specifications, or use outdoors or in a place exposed to direct sunlight.
2. Installation on equipment in conjunction with atomic energy, railways, air navigation, space, shipping, vehicles, military, medical treatment, combustion and recreation, or equipment in contact with food and beverages, emergency stop circuits, clutch and brake circuits in press applications, safety equipment or other applications unsuitable for the standard specifications described in the product catalog.
3. An application which could have negative effects on people, property, or animals requiring special safety analysis.
4. Use in an interlock circuit, which requires the provision of double interlock for possible failure by using a mechanical protective function, and periodical checks to confirm proper operation.

### Caution

**1. The product is provided for use in manufacturing industries.**

The product herein described is basically provided for peaceful use in manufacturing industries.  
 If considering using the product in other industries, consult SMC beforehand and exchange specifications or a contract if necessary.  
 If anything is unclear, contact your nearest sales branch.

## Limited warranty and Disclaimer/ Compliance Requirements

The product used is subject to the following “Limited warranty and Disclaimer” and “Compliance Requirements”.  
 Read and accept them before using the product.

### Limited warranty and Disclaimer

1. The warranty period of the product is 1 year in service or 1.5 years after the product is delivered, whichever is first.\*2)
- Also, the product may have specified durability, running distance or replacement parts. Please consult your nearest sales branch.
2. For any failure or damage reported within the warranty period which is clearly our responsibility, a replacement product or necessary parts will be provided. This limited warranty applies only to our product independently, and not to any other damage incurred due to the failure of the product.
3. Prior to using SMC products, please read and understand the warranty terms and disclaimers noted in the specified catalog for the particular products.

**\*2) Vacuum pads are excluded from this 1 year warranty.**

A vacuum pad is a consumable part, so it is warranted for a year after it is delivered.  
 Also, even within the warranty period, the wear of a product due to the use of the vacuum pad or failure due to the deterioration of rubber material are not covered by the limited warranty.

### Compliance Requirements

1. The use of SMC products with production equipment for the manufacture of weapons of mass destruction (WMD) or any other weapon is strictly prohibited.
2. The exports of SMC products or technology from one country to another are governed by the relevant security laws and regulations of the countries involved in the transaction. Prior to the shipment of a SMC product to another country, assure that all local rules governing that export are known and followed.

### Caution

**SMC products are not intended for use as instruments for legal metrology.**

Measurement instruments that SMC manufactures or sells have not been qualified by type approval tests relevant to the metrology (measurement) laws of each country. Therefore, SMC products cannot be used for business or certification ordained by the metrology (measurement) laws of each country.

## Safety Instructions

Be sure to read the “Handling Precautions for SMC Products” (M-E03-3) and “Operation Manual” before use.

o o o o e c



s e s s c s c o s c o c o