

New

Modular Design with Uniform Body Style



Better visibility & environmental resistance



The bowl is covered with a transparent bowl guard!

* Body sizes 30 and larger

- The inside is visible from 360°.
- The bowl is completely protected from the environment, allowing for improved safety.

Inner bowl
Material: Polycarbonate

Transparent bowl guard
Material: Polycarbonate



New Attachments have been added.

Attachment combination examples

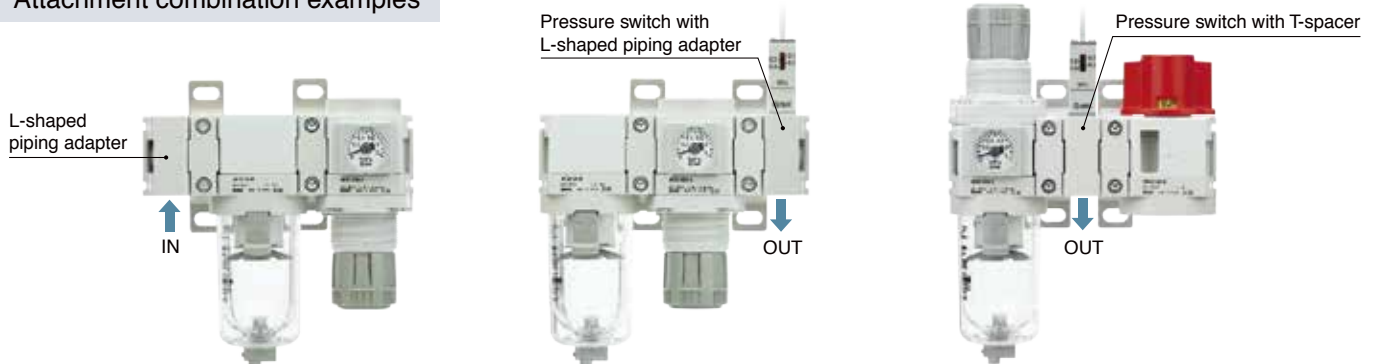

AC Series

Transparent bowl guard

Better environmental resistance: The transparent bowl guard protects the inner bowl!

The bowl guard with windows has been replaced with a **polycarbonate transparent bowl guard**. Now, even if the environment changes and the bowl is exposed to corrosive chemical or oil splash, **the foreign matter will not come into direct contact with the pressurized bowl**. This can reduce the risk of bowl breakage.

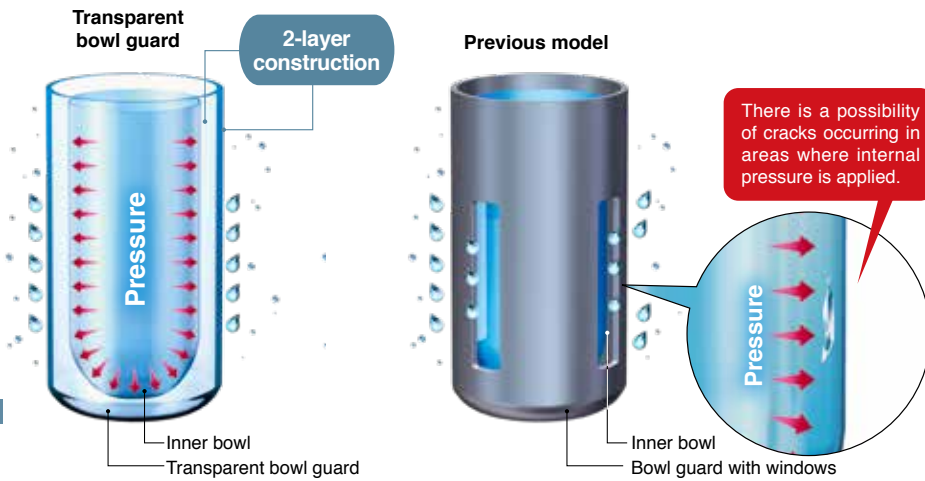

Better visibility: 360°

The transparent bowl guard allows for easy checking of the condensate level inside the filter bowl and the remaining oil amount in the lubricator from any direction.



Applicable model * Body sizes 30 and larger

Air Filter AF	Mist Separator AFM	Micro Mist Separator AFD	Filter Regulator AW□□(K)	Lubricator AL

No tools are required.

Easier replacement of the element
* AF-D only



Selection of pressure gauges



Square embedded type pressure gauge



Round type pressure gauge



Digital pressure switch

Open/close type gauge cover New

- ① Open the gauge cover.
- ② Adjust the indicator to a specified position.
- ③ Close the gauge cover.

Open the gauge cover in the direction of the arrow with your fingertips.

Adjust the indicator using a flat blade screwdriver.

Close the gauge cover in the direction of the arrow and push it in until it clicks in place.

Easy to handle

Easy to hold when unlocked

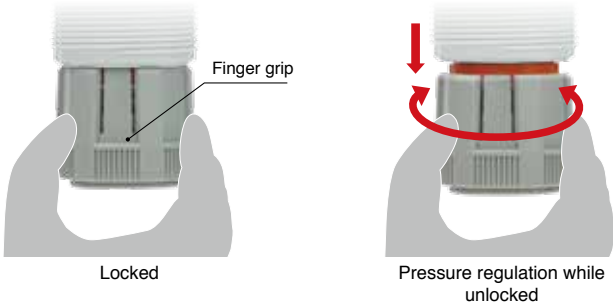

Interchangeability is maintained.

- The mounting pitch for panel mounting is interchangeable between the AR(K) and the AR(K)-B and between the AW(K) and the AW(K)-B.
- The brackets and set nuts are the same for both existing and new products.



AR(K) Series



AW(K) Series

Series Configuration

AC20 to AC40 Series

Air Filter + Regulator + Lubricator

AF AR AL



	Port size			
	1/8	1/4	3/8	1/2
Size 20	●	●		
Size 30		●	●	
Size 40		●	●	●

AC20A to AC40A Series

Filter Regulator + Lubricator

AW AL

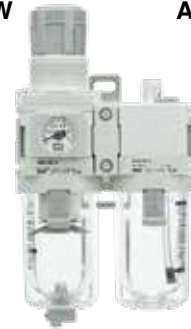

	Port size			
	1/8	1/4	3/8	1/2
Size 20	●	●		
Size 30		●	●	
Size 40		●	●	●

AC20B to AC40B Series

Air Filter + Regulator

AF AR



	Port size			
	1/8	1/4	3/8	1/2
Size 20	●	●		
Size 30		●	●	
Size 40		●	●	●

AC20C to AC40C Series

Air Filter + Mist Separator + Regulator

AF AFM AR



	Port size			
	1/8	1/4	3/8	1/2
Size 20	●	●		
Size 30		●	●	
Size 40		●	●	●

AC20D to AC40D Series

Filter Regulator + Mist Separator

AW AFM



	Port size			
	1/8	1/4	3/8	1/2
Size 20	●	●		
Size 30		●	●	
Size 40		●	●	●

Table of Modular F.R.L. Unit Combinations for AC Assembly

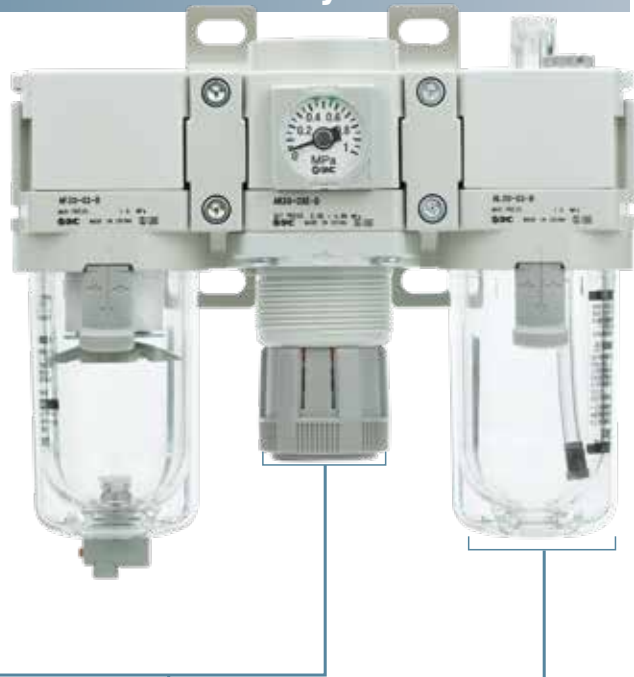

Air Filter
AF Series



Port size			
1/8	1/4	3/8	1/2
Size 20	●	●	
Size 30		●	●
Size 40		●	●

Mist Separator
Micro Mist Separator
AFM/AFD Series



Port size			
1/8	1/4	3/8	1/2
Size 20	●	●	
Size 30		●	●
Size 40		●	●

Size 20	●	●	
Size 30		●	●
Size 40		●	●

Regulator
AR Series



Port size			
1/8	1/4	3/8	1/2
Size 20	●	●	
Size 30		●	●
Size 40		●	●

Regulator with Backflow Function
AR□K Series



Port size			
1/8	1/4	3/8	1/2
Size 20	●	●	
Size 30		●	●
Size 40		●	●

Size 20	●	●	
Size 30		●	●
Size 40		●	●

Filter Regulator
AW Series



Port size			
1/8	1/4	3/8	1/2
Size 20	●	●	
Size 30		●	●
Size 40		●	●

Filter Regulator with Backflow Function
AW□K Series



Port size			
1/8	1/4	3/8	1/2
Size 20	●	●	
Size 30		●	●
Size 40		●	●

Size 20	●	●	
Size 30		●	●
Size 40		●	●

New Spacer

Interchangeable with the existing model

- The new spacer can be connected to the existing AF-A, AR-B, AL-A, and AW-B series.

Lubricator
AL Series





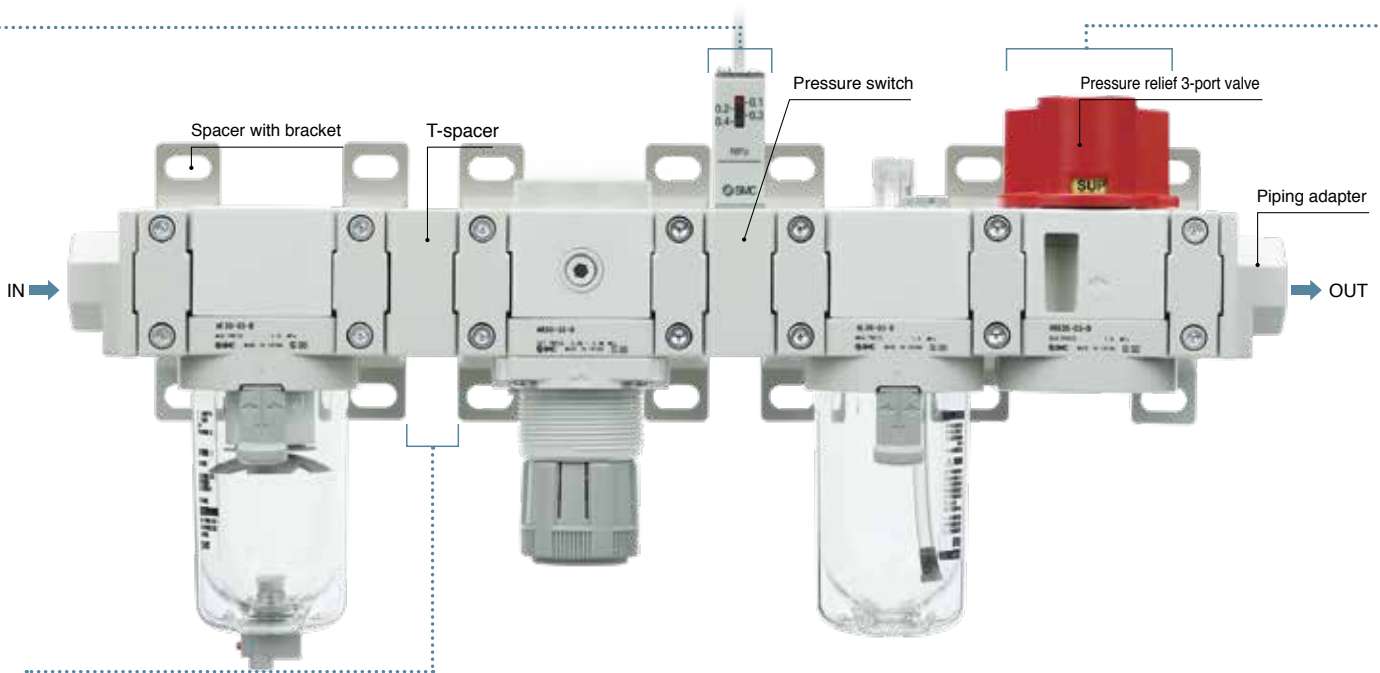

Port size			
1/8	1/4	3/8	1/2
Size 20	●	●	
Size 30		●	●
Size 40		●	●

Size 20	●	●	
Size 30		●	●
Size 40		●	●

Attachment List







Spacers

T-Spacer Y□10 Series	Cross Spacer Y□4 Series	Spacer Y□□ Series	Spacer with Bracket Y□□T Series
Piping in 2 directions is possible (upward or downward).	Piping in all 4 directions is possible.		
 Slim type* ¹	 Front and back port selectable type* ¹		

*1 The mounting pitch is interchangeable with the existing attachment.

Pressure Switches

A compact, integrated pressure switch can be easily installed to facilitate the pressure detection of the line.

New Pressure Switch with T-Spacer IS10T Series	New Pressure Switch with L-Shaped Piping Adapter IS10L Series	Pressure Switch IS10M Series	Pressure Switch with Piping Adapter IS10E Series
The OUT side piping can be branched downward.	OUT side piping: Downward		A piping adapter allows for the installation/removal of the component without removing the piping.
		 Slim type* ¹	

*1 The mounting pitch is interchangeable with the existing attachment.

Piping Adapters

Piping Adapter
E□00 Series

A piping adapter allows for the installation/removal of the component without removing the piping.



New

L-Shaped Piping Adapter
E□00L Series

Upward or downward piping is possible on the inlet side and the outlet side of F.R.L. units.



Pressure Relief 3-Port Valve **New Design**

Pressure Relief 3-Port Valve
VHS Series

By using a pressure relief 3-port valve, pressure left in the line can be easily exhausted.



Space saving/Reduced piping labor

Space saving

Max. 16.4%^{*1} reduction
Approx. 46 mm ← **Approx. 55 mm**
 *1 For size 30

Reduced piping labor

Number of screw-in connections
1 location ← **2 locations**

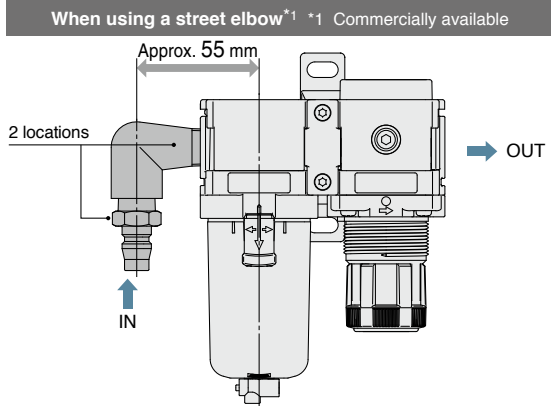
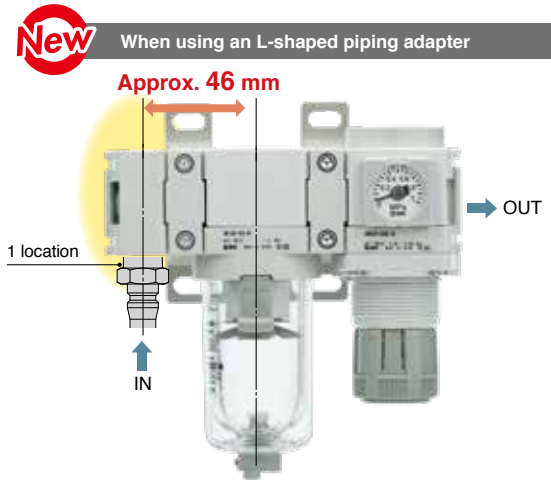

Global Manufacturing, Distribution and Service Network

Worldwide Subsidiaries

EUROPE

AUSTRIA
SMC Pneumatik GmbH (Austria)

BELGIUM
SMC Pneumatics N.V./S.A.

BULGARIA
SMC Industrial Automation Bulgaria EOOD

CROATIA
SMC Industrijska Automatika d.o.o.

CZECH REPUBLIC
SMC Industrial Automation CZ s.r.o.

DENMARK
SMC Pneumatik A/S

ESTONIA
SMC Pneumatics Estonia

FINLAND
SMC Pneumatics Finland OY

FRANCE
SMC Pneumatique S.A.

GERMANY
SMC Pneumatik GmbH

GREECE
SMC Hellas EPE

HUNGARY
SMC Hungary Ipari Automatizálási Kft.

IRELAND
SMC Pneumatics (Ireland) Ltd.

ITALY
SMC Italia S.p.A.

KAZAKHSTAN
LLP "SMC Kazakhstan"

LATVIA
SMC Pneumatics Latvia SIA

LITHUANIA
UAB "SMC Pneumatics"

NETHERLANDS
SMC Pneumatics B.V.

NORWAY
SMC Pneumatics Norway AS

POLAND
SMC Industrial Automation Polska Sp. z o.o.

ROMANIA
SMC Romania S.r.l.

RUSSIA
SMC Pneumatik LLC.

SLOVAKIA
SMC Priemysel'na' Automatizacia, Spol s.r.o.

SLOVENIA
SMC Pneumatika Avtomatika d.o.o.

SPAIN / PORTUGAL
SMC España, S.A.

SWEDEN
SMC Pneumatics Sweden AB

SWITZERLAND
SMC Pneumatik AG

TURKEY
SMC Pnömatik Sanayi Ticaret ve Servis A.Ş.

UK
SMC Pneumatics (U.K.) Ltd.

ASIA / OCEANIA

AUSTRALIA
SMC Pneumatics (Australia) Pty. Ltd.

CHINA
SMC (China) Co., Ltd.
SMC Pneumatics (Guangzhou) Ltd.

HONG KONG
SMC Pneumatics (Hong kong) Ltd.

INDIA
SMC Pneumatics (India) Pvt. Ltd.

INDONESIA
PT. SMC Pneumatics Indonesia

JAPAN
SMC Corporation

MALAYSIA
SMC Pneumatics (S.E.A.) Sdn. Bhd.

NEW ZEALAND
SMC Pneumatics (N.Z.) Ltd.

PHILIPPINES
Shoketsu SMC Corporation

SINGAPORE
SMC Pneumatics (S.E.A.) Pte. Ltd.

SOUTH KOREA
SMC Pneumatics Korea Co., Ltd.

TAIWAN
SMC Pneumatics (Taiwan) Co., Ltd.

THAILAND
SMC (Thailand) Ltd.

UNITED ARAB EMIRATES
SMC Pneumatics Middle East FZE

VIETNAM
SMC Pneumatics (VN) Co., Ltd

AFRICA

SOUTH AFRICA
SMC Pneumatics (South Africa) Pty Ltd

NORTH, CENTRAL & SOUTH AMERICA

ARGENTINA
SMC Argentina S.A.

BOLIVIA
SMC Pneumatics Bolivia S.R.L.

BRAZIL
SMC Pneumáticos do Brasil Ltda.

CANADA
SMC Pneumatics (Canada) Ltd.

CHILE
SMC Pneumatics (Chile) S.A.

COLOMBIA
SMC Colombia Sucursal de SMC Chile, S.A.

MEXICO
SMC Corporation (Mexico) S.A. de C.V.

PERU
SMC Corporation Peru S.A.C.

USA
SMC Corporation of America

VENEZUELA
SMC Neumatica Venezuela S.A.

U.S. & Canadian Sales Offices

- WEST**
- Austin
 - Dallas
 - Los Angeles
 - Phoenix
 - Portland
 - San Jose
- CENTRAL**
- Chicago
 - Cincinnati
 - Cleveland
 - Detroit
 - Des Moines
 - Grand Rapids
 - Indianapolis
 - Kansas City
 - Milwaukee
 - Minneapolis
 - St. Louis

- EAST**
- Albany
 - Atlanta
 - Birmingham
 - Boston
 - Charlotte
 - Knoxville
 - Nashville
 - New Jersey
 - Rochester
 - Tampa
- CANADA**
- Vancouver
 - Toronto
 - Windsor
 - Montreal

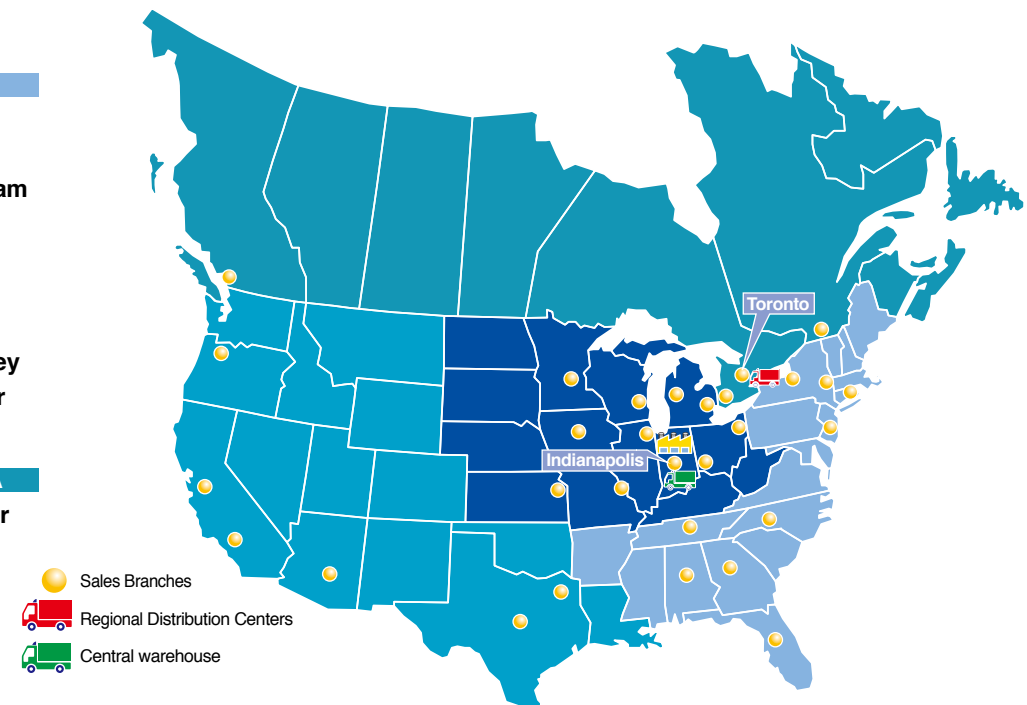

o o o o e c



s e s s c s c o s c o c o