

Intermediary Bore Sizes

A **foot type** and a **flange type** have been added.

New

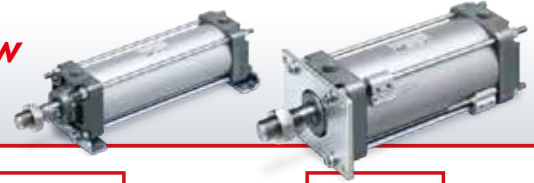

○ Air Saving ○ Space Saving

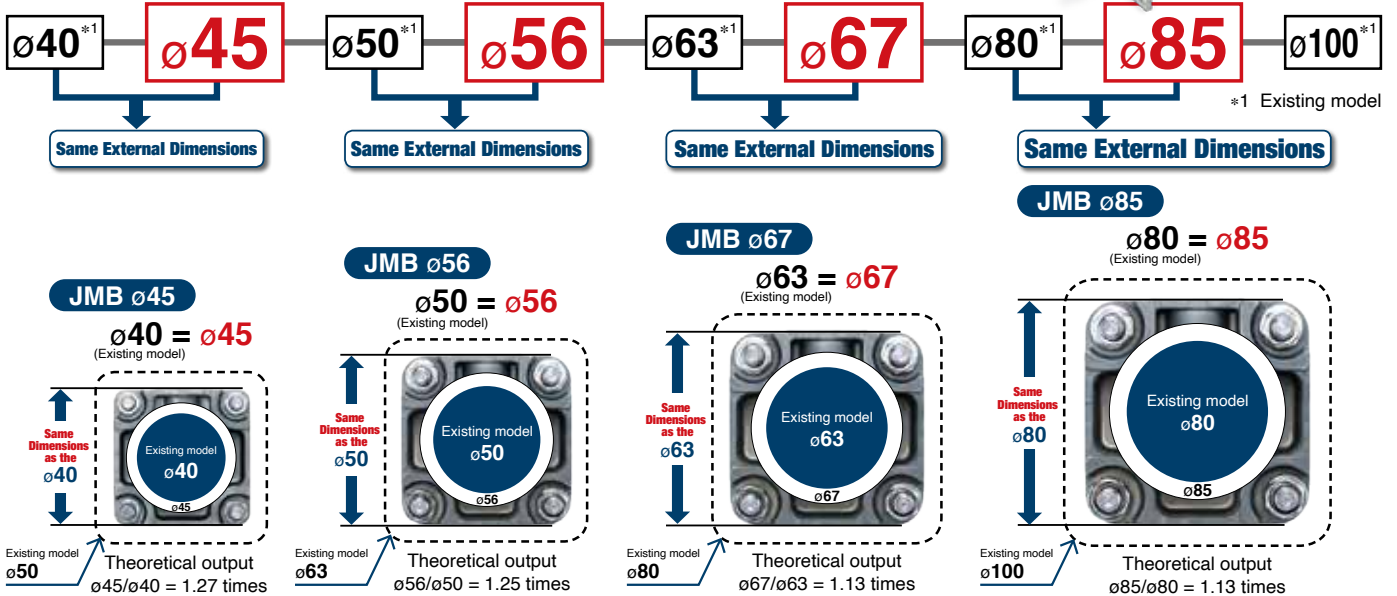

Overall Length Shortened



Max.

Weight

36% lighter

3.34 lb → 2.2 lb
(1.56 kg) (1.00 kg)

(Compared with the existing MB series model, ø50, 3.94 inch (100 mm stroke))

JMB Series



Air saving Reduced by up to 29%

Air consumption can be reduced by optimal size selection.

Bore size [mm]	ø40	ø45	ø50	ø56	ø63	ø67	ø80	ø85	ø100
Air consumption L (ANR)	1.4	1.8	2.2	2.8	3.6	4.1	5.8	6.6	9.1

Conditions/Supply pressure: 0.5 MPa
Load factor: 50%, At 100 mm stroke

18% reduction

22% reduction

29% reduction

27% reduction

Example

In order to move a workpiece with a weight of 37 kg, a bore size of ø43 or more is required. Previously, a ø50 bore size would have been the closest option since the next smallest size, the ø40, has insufficient output. However, with the newly released bore size of ø45, sufficient output can be obtained while also saving air due to a 0.4 L (ANR) reduction in air consumption compared with the ø50.

* Conditions/Supply pressure: 0.5 MPa, Load factor: 50%

Current bore size output

Bore size [mm]	Output*1 [kg]	Air consumption [L (ANR)]	Judgment when 37 kg of output is required
ø40	32.0	1.4	Not acceptable
ø50	50.1	2.2	Acceptable

*1 Supply pressure: 0.5 MPa, Load factor: 50%

When the intermediary bore size of ø45 is used

Bore size [mm]	Output*1 [kg]	Air consumption [L (ANR)]	Judgment when 37 kg of output is required
ø45	40.6	1.8	Acceptable

*1 Supply pressure: 0.5 MPa, Load factor: 50%

Air consumption ø50: 2.2 L (ANR) – ø45: 1.8 L (ANR) = 0.4 L (ANR)

18% reduction

Compact and lightweight (ø32, ø40, ø50, ø63, ø80, ø100)



(Compared with the existing MB series model)

Bore size [mm]	W: Width		L: Overall length		Weight	
	Existing model W1 [mm]	JMB W2 [mm]	Existing model L1 [mm]	JMB L2 [mm]	Existing model [kg]	JMB [kg]
ø32	46	42	235	209	0.66	0.43
ø40	52	48	239	214	0.91	0.64
ø45		52		214		0.68
ø50	65	60	256	229	1.56	1.00
ø56		65		229		1.09
ø63	75	70	256	235	1.83	1.28
ø67		75		235		1.51
ø80	95	88	290	258	3.25	2.18
ø85		95		259		2.67
ø100	114	110	290	268	4.48	3.48

* Compared at a 100 mm stroke

Reduces Labor Time

- Air cushion adjustment is not required due to the non-adjustable air cushion...
- The built-in rubber bumper reduces the metal noise that occurs when the piston stops...

Lightweight and compact

Weight comparison between cylinders with a bracket



Flange bracket

Weight: Max. 49% reduction Weight comparison
(When mounted on the cylinder, 100 mm stroke) [kg]

Bore size [mm]	MB	JMB	Weight difference	Reduction rate [%]
ø32	0.95	0.49	0.46	49
ø40	1.28	0.71	0.57	45
ø50	2.01	1.11	0.9	45
ø63	2.62	1.49	1.13	43
ø80	4.7	2.53	2.17	46
ø100	7.79	4.08	3.71	48

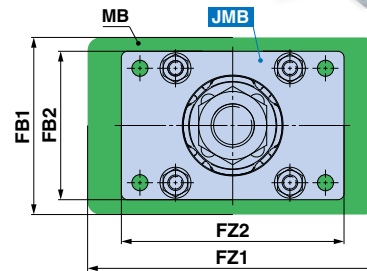

Dimension comparison (When mounted on the cylinder) [mm]

Width: Max. 20% reduction, Height: 16% reduction

Bore size	Width				Height			
	MB: FZ1	JMB: FZ2	Reduction	Reduction rate [%]	MB: FB1	JMB: FB2	Reduction	Reduction rate [%]
ø32	79	65	14	18	50	42	8	16
ø40	90	72	18	20	55	48	7	13
ø50	110	89	21	19	70	60	10	14
ø63	120	100	20	17	80	70	10	13
ø80	153	127	26	17	100	90	10	10
ø100	178	154	24	13	120	110	10	8

Foot bracket

Weight: Max. 35% reduction Weight comparison
(When mounted on the cylinder, 100 mm stroke) [kg]

Bore size [mm]	MB	JMB	Weight difference	Reduction rate [%]
ø32	0.78	0.52	0.26	33
ø40	1.05	0.74	0.31	30
ø50	1.78	1.16	0.62	35
ø63	2.11	1.56	0.55	26
ø80	3.75	2.7	1.05	28
ø100	5.14	4.21	0.93	18



Height: 11% reduction Dimension comparison
(When mounted on the cylinder) [mm]

Bore size	Height			
	MB: LY1	JMB: LY2	Reduction	Reduction rate [%]
ø32	53	47	6	11
ø40	59	53	6	10
ø50	72.5	66	6.5	9
ø63	82.5	77	5.5	7
ø80	102.5	98	4.5	4
ø100	122	121	1	1

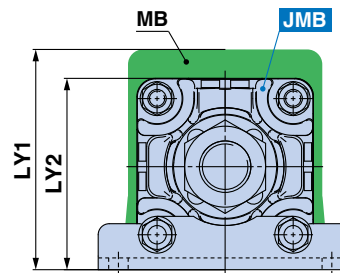

New Part numbers for products with a rod end bracket are available.

It is not necessary to order a bracket for the applicable cylinder separately.

* The rod end bracket is shipped together with the product but does not come assembled.

* Rod end brackets are the same as those for the MB series.

Example) **JMDBB40-50- V -M9BW**

Rod end bracket

Nil	No bracket
V	Single knuckle joint
W	Double knuckle joint

With rod end bracket

V: Single knuckle joint W: Double knuckle joint



CONTENTS

How to Order p. 3
 Specifications p. 4
 Dimensions p. 6
 Auto Switch Mounting p. 8

Prior to Use: Auto Switch Connections and Examples p. 9
 Specific Product Precautions p. 10
 Safety Instructions Back cover

Air Cylinder

Double Acting, Single Rod



JMB Series

ø32, ø40, ø45, ø50, ø56, ø63, ø67, ø80, ø85, ø100

How to Order

With auto switch **JMDB B 32** **50** **M9BW**

With auto switch (Built-in magnet)
* Not available without a magnet

Mounting

B	Basic
L	Axial foot
F	Rod flange
G	Head flange

* "L," "F," and "G" cannot be selected for bore sizes ø45, ø56, ø67, and ø85.

Bore size

32	32 mm
40	40 mm
45	45 mm
50	50 mm
56	56 mm
63	63 mm
67	67 mm
80	80 mm
85	85 mm
100	100 mm

Number of auto switches

Nil	2
S	1
3	3
n	n

Auto switch

Nil	Without auto switch
------------	---------------------

* For applicable auto switches, refer to the table below.

Rod end bracket

Nil	No bracket
V	Single knuckle joint
W	Double knuckle joint

* A knuckle joint pin is not provided with the single knuckle joint.
* The rod end bracket is shipped together with the product.

Cylinder stroke [mm]
Refer to page 4 for standard strokes.

Port thread type

Nil	Rc
TN	NPT
TF	G

Applicable Auto Switches/Refer to the Web Catalog for further information on auto switches.

Type	Special function	Electrical entry	Indicator light	Wiring (Output)	Load voltage		Auto switch model		Lead wire length [m]				Pre-wired connector	Applicable load		
					DC	AC	Perpendicular	In-line	0.5 (Nil)	1 (M)	3 (L)	5 (Z)		IC circuit	Relay, PLC	
Solid state auto switch	—	Grommet	Yes	3-wire (NPN)	24 V	5 V, 12 V	—	M9NV	M9N	●	●	●	○	○	IC circuit	Relay, PLC
				3-wire (PNP)				M9PV	M9P	●	●	●	○	○		
				2-wire				M9BV	M9B	●	●	●	○	○		
				3-wire (NPN)				M9NVW	M9NW	●	●	●	○	○		
	Diagnostic indication (2-color indicator)			3-wire (PNP)	M9PVW	M9PW	●	●	●	○	○	IC circuit				
				2-wire	M9BWW	M9BW	●	●	●	○	○					
	Water resistant (2-color indicator)			3-wire (NPN)	M9NAV^{*1}	M9NA^{*1}	○	○	●	○	○	IC circuit				
				3-wire (PNP)	M9PAV^{*1}	M9PA^{*1}	○	○	●	○	○					
				2-wire	M9BAV^{*1}	M9BA^{*1}	○	○	●	○	○					
				2-wire			○	○	●	○	○					

*1 Water-resistant type auto switches can be mounted on the above models, but SMC cannot guarantee water resistance.

Please contact SMC regarding water-resistant types with the above model numbers.

* Lead wire length symbols: 0.5 m..... Nil (Example) M9NW * Solid state auto switches marked with "○" are produced upon receipt of order.
1 m..... M (Example) M9NWM
3 m..... L (Example) M9NWL
5 m..... Z (Example) M9NWZ

* For details on auto switches with pre-wired connectors, refer to the Web Catalog.

* Auto switches and auto switch mounting brackets are shipped together with the product but do not come assembled.



Specifications

Bore size [mm]	32	40	45	50	56	63	67	80	85	100	
Action	Double acting, Single rod										
Fluid	Air										
Proof pressure	1.0 MPa										
Max. operating pressure	0.7 MPa*2										
Min. operating pressure	0.05 MPa										
Ambient and fluid temperatures	5 to 60°C										
Lubrication	Not required (Non-lube)										
Piston speed*1	50 to 500 mm/s*2										
Stroke length tolerance	+2.0 0										
Cushion	Non-adjustable air cushion + rubber bumper										
Port size (Rc, NPT, G)	1/8							1/4		3/8	
Mounting	Basic										

*1 Depending on the system configuration selected, the specified speed may not be satisfied.

*2 Max. operating pressure and piston speed are different from those of the existing model (MB series).

Standard Strokes

Bore size [mm]	Standard stroke [mm]	Max. manufacturable stroke
32	25, 50, 75, 100, 125, 150, 175, 200, 250, 300	300
40	25, 50, 75, 100, 125, 150, 175, 200, 250, 300	300
45	25, 50, 75, 100, 125, 150, 175, 200, 250, 300	300
50	25, 50, 75, 100, 125, 150, 175, 200, 250, 300, 350, 400	400
56	25, 50, 75, 100, 125, 150, 175, 200, 250, 300, 350, 400	400
63	25, 50, 75, 100, 125, 150, 175, 200, 250, 300, 350, 400	400
67	25, 50, 75, 100, 125, 150, 175, 200, 250, 300, 350, 400	400
80	25, 50, 75, 100, 125, 150, 175, 200, 250, 300, 350, 400, 450, 500	500
85	25, 50, 75, 100, 125, 150, 175, 200, 250, 300, 350, 400, 450, 500	500
100	25, 50, 75, 100, 125, 150, 175, 200, 250, 300, 350, 400, 450, 500	500



Precautions

Be sure to read this before handling the products. Refer to the back cover for safety instructions. For actuator and auto switch precautions, refer to the "Handling Precautions for SMC Products" and the "Operation Manual" on the SMC website: <https://www.smc.com>

Refer to page 8 for cylinders with auto switches.

- Auto Switch Proper Mounting Position (Detection at stroke end) and Mounting Height
- Minimum Stroke for Auto Switch Mounting
- Operating Range
- Auto Switch Mounting Brackets/Part Nos.

Theoretical Output

[Unit: N] IN

Bore size [mm]	Rod size [mm]	Operating direction	Piston area [mm ²]	Operating pressure [MPa]					
				0.2	0.3	0.4	0.5	0.6	0.7
32	10	OUT	804	161	241	322	402	483	563
		IN	726	145	218	290	363	435	508
40	14	OUT	1257	251	377	503	628	754	880
		IN	1103	221	331	441	551	662	772
45	14	OUT	1590	318	477	636	795	954	1113
		IN	1436	287	431	575	718	862	1006
50	18	OUT	1963	393	589	785	982	1178	1374
		IN	1709	342	513	684	855	1025	1196
56	18	OUT	2463	493	739	985	1232	1478	1724
		IN	2209	442	663	883	1104	1325	1546
63	18	OUT	3117	623	935	1247	1559	1870	2182
		IN	2863	573	859	1145	1431	1718	2004
67	18	OUT	3526	705	1058	1410	1763	2115	2468
		IN	3271	654	981	1308	1636	1963	2290
80	22	OUT	5027	1005	1508	2011	2513	3016	3519
		IN	4646	929	1394	1859	2323	2788	3252
85	22	OUT	5675	1135	1702	2270	2837	3405	3972
		IN	5294	1059	1588	2118	2647	3177	3706
100	26	OUT	7854	1571	2356	3142	3927	4712	5498
		IN	7323	1465	2197	2929	3662	4394	5126

* Theoretical output [N] = Pressure [MPa] x Piston area [mm²]

UNIT CONVERSIONS

	unit	conversion	result		unit	conversion	result
length	m	x 3.28	ft	pressure	MPa	x 145	psi
	mm	x 0.04	in		kPa	÷ 6.895	psi
mass	g	x 0.04	oz	temperature	°C	x 1.8 then add 32	°F
volume	cm ³	÷ 16.387	in ³	torque	N·m	x 0.738	ft·lb
	L	x 61.024	in ³	force	N	÷ 4.448	lbf
speed	mm/s	÷ 25.4	in/s	flow	L/min	÷ 28.317	cfm

JMB Series

Mounting Brackets/Part Nos.

Mounting bracket	Min. order quantity	Bore size [mm]										Contents
		32	40	45	50	56	63	67	80	85	100	
Foot bracket*1	2	JMB-L032	JMB-L040	—	JMB-L050	—	JMB-L063	—	JMB-L080	—	JMB-L100	1 foot bracket, 2 hexagon nuts, 2 flat washers
Flange bracket	1	JMB-F032	JMB-F040	—	JMB-F050	—	JMB-F063	—	JMB-F080	—	JMB-F100	1 flange bracket, 4 hexagon nuts, 4 flat washers
Single knuckle joint	1	I-03M	I-04M	I-05M			I-08M			I-10M	1 single knuckle joint	
Double knuckle joint	1	Y-03M	Y-04M	Y-05M			Y-08M			Y-10M	1 double knuckle joint, 1 pin, 2 split pins, 2 flat washers	

*1 Order two foot brackets per cylinder.

Mounting Brackets/Material, Surface Treatment

Segment	Description	Material	Surface treatment
Mounting brackets	Foot bracket	Carbon steel	Zinc chromating
	Flange bracket	Carbon steel	Zinc chromating
Accessories	Single knuckle joint	Free cutting carbon steel	Zinc chromating
	Double knuckle joint	Cast iron	Metallic silver color painting
	Knuckle joint pin	Carbon steel	(None)

Weight

Bore size [mm]		32	40	45	50	56	63	67	80	85	100	[kg]
Basic weight	Basic	0.21	0.30	0.32	0.62	0.69	0.88	1.03	1.54	1.91	2.56	
Additional weight per 50 mm of stroke		0.11	0.17	0.18	0.19	0.20	0.20	0.24	0.32	0.38	0.46	
Additional weight for mounting bracket	Foot bracket	0.04	0.05	—	0.08	—	0.14	—	0.26	—	0.36	
	Flange bracket	0.06	0.07	—	0.11	—	0.21	—	0.35	—	0.60	
Accessories	Single knuckle joint	0.15	0.23	0.23	0.26	0.26	0.26	0.26	0.60	0.60	0.83	
	Double knuckle joint (with pin)	0.22	0.37	0.37	0.43	0.43	0.43	0.43	0.87	0.87	1.27	

Calculation example) **JMDBL50-100**

- Basic weight.....0.62 (Basic, ø50)
 - Additional weight.....0.19/50 mm stroke
 - Stroke.....100 mm stroke
 - Foot bracket (2 pcs.).....0.08 x 2
- $$0.62 + (0.19 \times 100/50) + (0.08 \times 2) = 1.16 \text{ kg}$$

Allowable Kinetic Energy

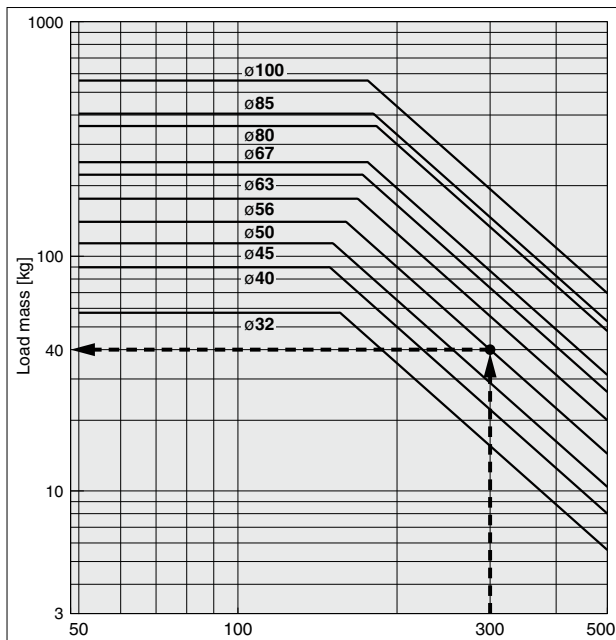

Example) Load limit at rod end when the air cylinder ø50 is actuated at 300 mm/s
 Extend upward from 300 mm/s on the horizontal axis of the graph to the intersection point with the line for a tube bore size of 50 mm, and then extend leftward from this point to find the load of 40 kg.

Allowable Lateral Load at Rod End

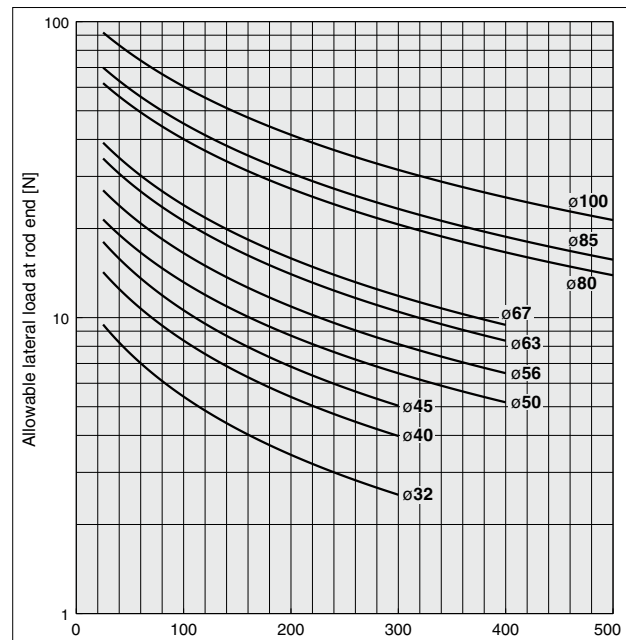

Air Cylinder Double Acting, Single Rod **JMB Series**



Dimensions

Basic: JMDBB

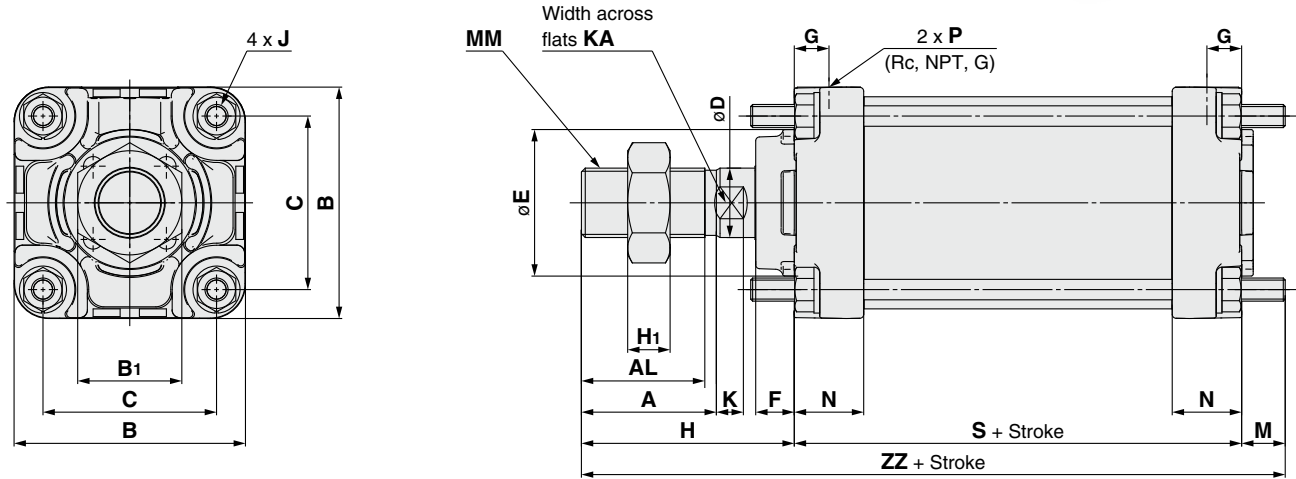

Bore size	Stroke range	A	AL	B	B ₁	C	D	E	F	G	H	H ₁	J	K	KA	M	MM	N	P	S	ZZ
32	Up to 300	22	19.5	42	17	31	10	24	8	9	38	6	M5 x 0.8	5.5	8	8	M10 x 1.25	18	1/8	63	109
40	Up to 300	24	21	48	22	37	14	32	9	9	44	8	M5 x 0.8	8	12	8	M14 x 1.5	18	1/8	62	114
45	Up to 300	24	21	52	22	41	14	32	9	9	44	8	M5 x 0.8	8	12	8	M14 x 1.5	18	1/8	62	114
50	Up to 400	35	32	60	27	45	18	38	10	9	55	11	M6 x 1	7	16	11	M18 x 1.5	18	1/8	63	129
56	Up to 400	35	32	65	27	50	18	38	10	9	55	11	M6 x 1	7	16	11	M18 x 1.5	18	1/8	63	129
63	Up to 400	35	32	70	27	55	18	38	6	11	51	11	M6 x 1	7	16	11	M18 x 1.5	22	1/4	73	135
67	Up to 400	35	32	75	27	58	18	38	6	11	51	11	M8 x 1.25	7	16	11	M18 x 1.5	22	1/4	73	135
80	Up to 500	40	37	88	32	69	22	45	12	13	62	13	M8 x 1.25	7	19	13	M22 x 1.5	26	1/4	83	158
85	Up to 500	40	37	95	32	74	22	45	12	13	62	13	M10 x 1.25	7	19	14	M22 x 1.5	26	1/4	83	159
100	Up to 500	40	37	110	41	87	26	50	10	14	66	16	M10 x 1.25	12	23	14	M26 x 1.5	28	3/8	88	168

Rod end nut (Standard)

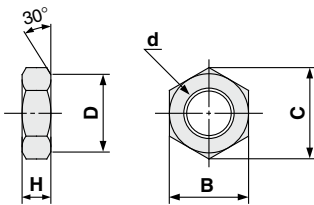

Part no.	Bore size	d	H	B	C	D
NT-03	32	M10 x 1.25	6	17	19.6	16.5
NT-04	40, 45	M14 x 1.5	8	22	25.4	21
NT-05	50, 56, 63, 67	M18 x 1.5	11	27	31.2	26
NT-08	80, 85	M22 x 1.5	13	32	37.0	31
NT-10	100	M26 x 1.5	16	41	47.3	39

JMB Series

Dimensions

Axial foot: JMBL

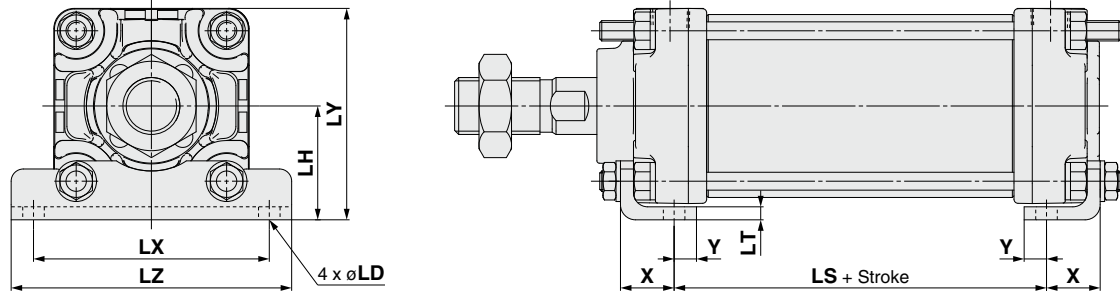

Bore size	LD	LH	LS	LT	LX	LY	LZ	X	Y
32	5.5	26	46	3.2	52	47	64	12	6.3
40	5.5	29	44	3.2	58	53	69	12	5.5
50	6.5	36	41	3.2	75	66	90	14	6.8
63	6.5	42	51	4.5	86	77	100	16	7.5
80	9	54	55	4.5	114	98	136	19	10
100	11	66	56	4.5	138	121	160	20.5	11.5

[mm]

Rod flange: JMBF

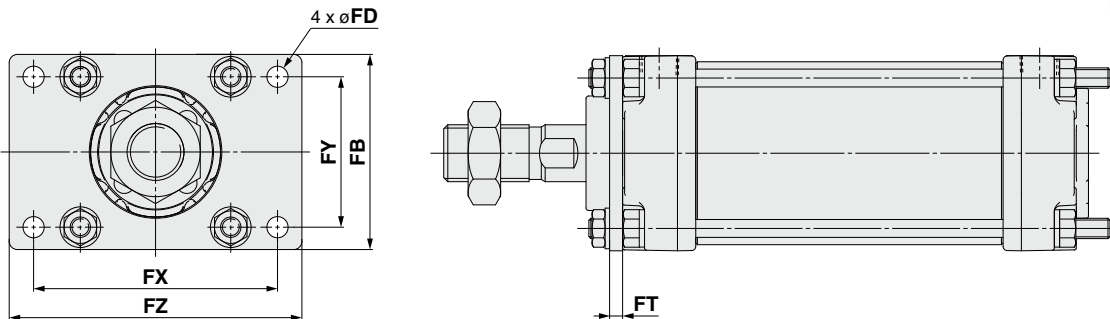

Head flange: JMBG

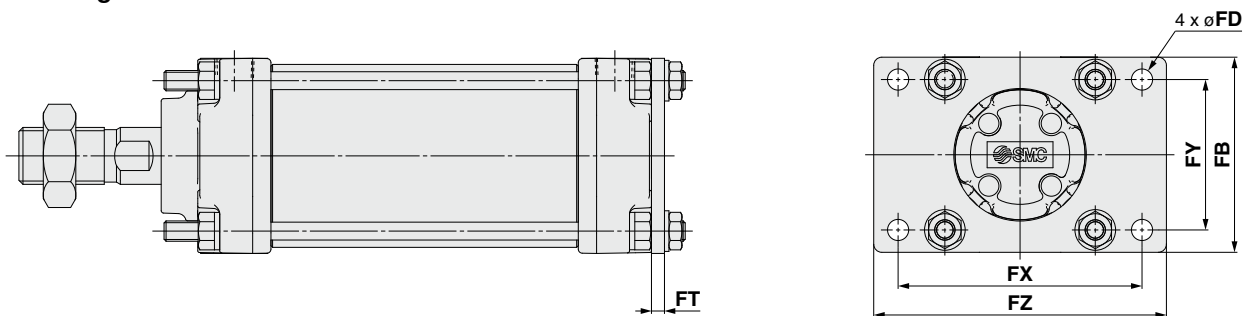

Bore size	FB	FD	FT	FX	FY	FZ
32	42	5.5	3.2	54	31	65
40	48	5.5	3.2	60	37	72
50	60	6.5	3.2	74	46	89
63	70	6.5	4.5	85	55	100
80	90	9	4.5	108	70	127
100	110	11	5	133	87	154

[mm]

JMB Series Auto Switch Mounting

Auto Switch Proper Mounting Position (Detection at stroke end) and Mounting Height

<Tie-rod mounting>

D-M9□/M9□V
D-M9□W/M9□WV
D-M9□A/M9□AV

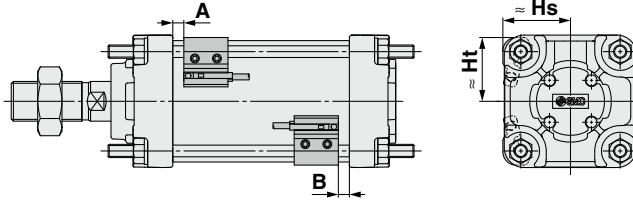

Auto Switch Proper Mounting Position [mm]

Auto switch model	D-M9□/M9□V D-M9□W/M9□WV D-M9□A/M9□AV	
	A	B
Bore size 32	7.5	7
40	6.5	7
45	6.5	7
50	7	6.5
56	7	6.5
63	8	8
67	8	8
80	9	9
85	9	9
100	9	10

* Adjust the auto switch after confirming the operating conditions in the actual setting.

Auto Switch Mounting Height [mm]

Auto switch model	D-M9□ D-M9□W D-M9□A		D-M9□V D-M9□WV D-M9□AV	
	Hs	Ht	Hs	Ht
Bore size 32	24.5	22.5	30.5	22.5
40	28.5	25.5	34	25.5
45	30.5	27.5	36	27.5
50	33	30	38.5	30
56	35	32.5	41	32.5
63	38.5	36	43	36
67	45.5	45	49.5	45
80	46.5	45	52	45
85	54	53.5	57.5	53.5
100	54	53.5	59.5	53.5

Minimum Stroke for Auto Switch Mounting

n: Number of auto switches [mm]

Auto switch model	Number of auto switches	ø32, ø40, ø45, ø50, ø56, ø63, ø67, ø80, ø85, ø100
D-M9□ D-M9□W	2 (Different surfaces, Same surface), 1	15
	n	$15 + 40 \frac{(n-2)}{2}$ (n = 2, 4, 6, 8...)*1
D-M9□V D-M9□WV	2 (Different surfaces, Same surface), 1	10
	n	$10 + 30 \frac{(n-2)}{2}$ (n = 2, 4, 6, 8...)*1
D-M9□A	2 (Different surfaces, Same surface), 1	15
	n	$15 + 40 \frac{(n-2)}{2}$ (n = 2, 4, 6, 8...)*1
D-M9□AV	2 (Different surfaces, Same surface), 1	15
	n	$15 + 30 \frac{(n-2)}{2}$ (n = 2, 4, 6, 8...)*1

*1 When "n" is an odd number, an even number that is one larger than the odd number is to be used for the calculation.

Operating Range

[mm]

Auto switch model	D-M9□/M9□V D-M9□W/M9□WV D-M9□A/M9□AV
Bore size 32	3.5
40	4
45	4
50	4
56	4.5
63	5
67	4.5
80	5
85	5.5
100	5.5

* Values which include hysteresis are for reference purposes only. They are not a guarantee (assuming approximately ±30% dispersion) and may change substantially depending on the ambient environment.

Auto Switch Mounting Brackets/Part Nos.

[mm]

Auto switch model	D-M9□/M9□V D-M9□W/M9□WV D-M9□A/M9□AV
Bore size 32	BMB10-032
40	BMB10-032
45	BMB10-032
50	BMB5-032
56	BMB5-032
63	BMB5-032
67	BA7-040
80	BA7-040
85	BA7-063
100	BA7-063

[Stainless Steel Mounting Screw Kit]

The following stainless steel mounting screw kit (including set screws) is available. Use it in accordance with the operating environment. (Since the auto switch mounting bracket is not included, order it separately.)

* When using the D-M9□A(V), do not use the steel set screws which are included with the auto switch mounting brackets shown to the left (BMB10-032, BMB5-032, BA7-040, BA7-063). Order a stainless steel screw kit (BBA1) separately, and use the M4 x 6 L stainless steel set screws included in the BBA1.

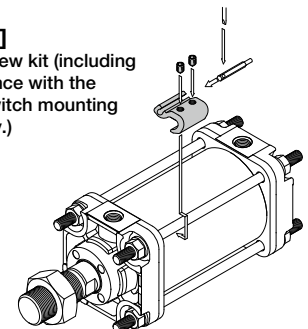

Prior to Use

Auto Switch Connections and Examples

Sink Input Specifications

3-wire, NPN

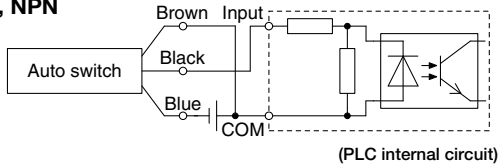

2-wire

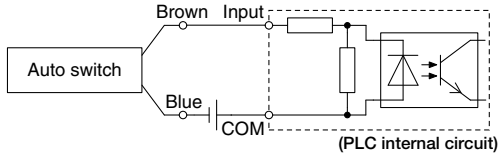

Source Input Specifications

3-wire, PNP

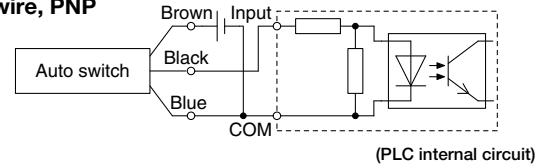

2-wire

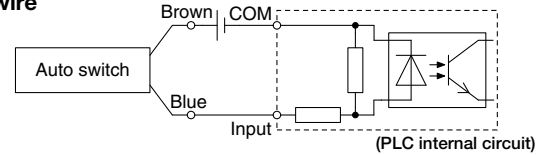

Connect according to the applicable PLC input specifications, as the connection method will vary depending on the PLC input specifications.

Examples of AND (Series) and OR (Parallel) Connections

* When using solid state auto switches, ensure the application is set up so the signals for the first 50 ms are invalid. Depending on the operating environment, the product may not operate properly.

3-wire AND connection for NPN output

(Using relays)

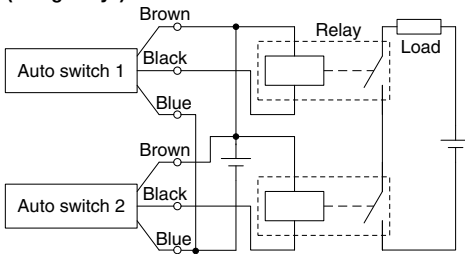

(Performed with auto switches only)

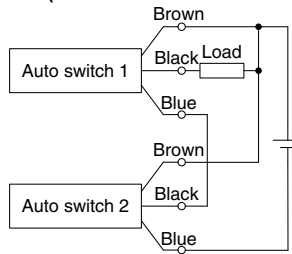

3-wire OR connection for NPN output

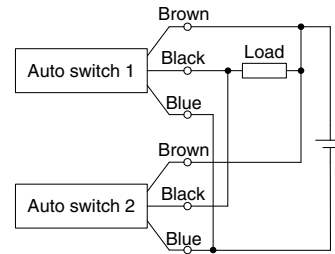

3-wire AND connection for PNP output

(Using relays)

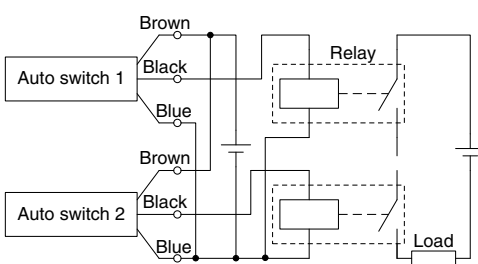

(Performed with auto switches only)

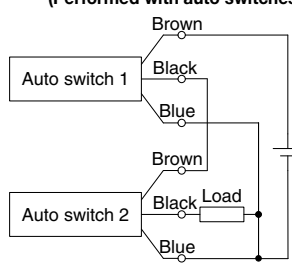

3-wire OR connection for PNP output

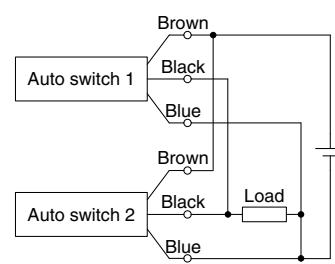

2-wire AND connection

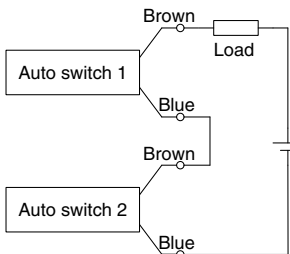

When two auto switches are connected in series, a load may malfunction because the load voltage will decline when in the ON state. The indicator lights will light up when both of the auto switches are in the ON state. Auto switches with a load voltage less than 20 V cannot be used. Please contact SMC if using AND connection for a heat-resistant solid state auto switch or a trimmer switch.

Example) Load voltage at ON
Power supply voltage: 24 VDC
Internal voltage drop: 4 V

$$\begin{aligned} \text{Load voltage at ON} &= \text{Power supply voltage} - \\ &\quad \text{Internal voltage drop} \times 2 \text{ pcs.} \\ &= 24 \text{ V} - 4 \text{ V} \times 2 \text{ pcs.} \\ &= 16 \text{ V} \end{aligned}$$

2-wire OR connection

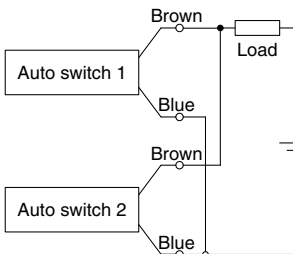

(Solid state)
When two auto switches are connected in parallel, malfunction may occur because the load voltage will increase when in the OFF state.

(Reed)
Because there is no current leakage, the load voltage will not increase when turned OFF. However, depending on the number of auto switches in the ON state, the indicator lights may sometimes grow dim or not light up, due to the dispersion and reduction of the current flowing to the auto switches.

Example) Load voltage at OFF
Leakage current: 1 mA
Load impedance: 3 kΩ
Load voltage at OFF = Leakage current x 2 pcs. x Load impedance
= 1 mA x 2 pcs. x 3 kΩ
= 6 V



JMB Series Specific Product Precautions

Be sure to read this before handling the products. Refer to the back cover for safety instructions. For actuator and auto switch precautions, refer to the “Handling Precautions for SMC Products” and the “Operation Manual” on the SMC website.

Mounting

Caution

1. Allowable lateral load

Lateral load that can apply to the piston rod end is limited. If a cylinder is used with a lateral load over the limit, it may cause air leakage due to abnormal friction of seals, galling of cylinder tubes and pistons, or abnormal friction of the bearing part. The lateral load applied to the piston rod must be within the allowable range indicated in this catalog. When the load exceeds the limit, install a guide or change the bore size to suit the load in order to make the load within the allowable range.

2. Connection with a workpiece

When a workpiece is mounted on the piston rod end, connect them aligning the center of piston rod and a workpiece. If they are off-center, lateral load is generated and phenomena mentioned in 1. may occur. In order not to apply the off-center load, use of a floating joint is recommended.

3. Use the tightening torques shown below when replacing mounting brackets.

Bore size [mm]	Tightening torque [N·m]
32, 40	1.79 to 2.42
50, 63	3.09 to 4.19
80	6.38 to 8.63
100	12.5 to 16.91

4. When replacing the mounting bracket, the tie-rod tightening nut on the cylinder body may also loosen.

After retightening the tie-rod tightening nut with the proper tightening torque (refer to 3. above), install the mounting bracket.

5. Simultaneous use of multiple cylinders

It is difficult to control the speed of pneumatic cylinders. The following conditions cause speed change: change in supply pressure, load, temperature and lubrication, performance difference of each cylinder, deterioration of each part over time, etc. Speed controller can be used to control the speed of multiple cylinders simultaneously for a short period of time, but depending on conditions, it may not work as desired. If multiple cylinders cannot operate simultaneously, unreasonable force is applied to the piston rod because cylinder positions may not be the same. This may cause abnormal friction of seals and bearings, and galling of cylinder tubes and pistons. Do not use an application to operate several cylinders simultaneously by adjusting cylinder speed. If this is inevitable, use a high rigid guide against load, so that the cylinder is not damaged even when the each cylinder output is slightly different.

6. Depending on the system configuration selected, the specified speed may not be satisfied.

Safety Instructions

These safety instructions are intended to prevent hazardous situations and/or equipment damage. These instructions indicate the level of potential hazard with the labels of “**Caution**,” “**Warning**” or “**Danger**.” They are all important notes for safety and must be followed in addition to International Standards (ISO/IEC)*1), and other safety regulations.

 **Caution:** **Caution** indicates a hazard with a low level of risk which, if not avoided, could result in minor or moderate injury.

 **Warning:** **Warning** indicates a hazard with a medium level of risk which, if not avoided, could result in death or serious injury.

 **Danger :** **Danger** indicates a hazard with a high level of risk which, if not avoided, will result in death or serious injury.

*1) ISO 4414: Pneumatic fluid power – General rules relating to systems.
ISO 4413: Hydraulic fluid power – General rules relating to systems.
IEC 60204-1: Safety of machinery – Electrical equipment of machines.
(Part 1: General requirements)
ISO 10218-1: Manipulating industrial robots – Safety.
etc.

Warning

1. The compatibility of the product is the responsibility of the person who designs the equipment or decides its specifications.

Since the product specified here is used under various operating conditions, its compatibility with specific equipment must be decided by the person who designs the equipment or decides its specifications based on necessary analysis and test results. The expected performance and safety assurance of the equipment will be the responsibility of the person who has determined its compatibility with the product. This person should also continuously review all specifications of the product referring to its latest catalog information, with a view to giving due consideration to any possibility of equipment failure when configuring the equipment.

2. Only personnel with appropriate training should operate machinery and equipment.

The product specified here may become unsafe if handled incorrectly. The assembly, operation and maintenance of machines or equipment including our products must be performed by an operator who is appropriately trained and experienced.

3. Do not service or attempt to remove product and machinery/equipment until safety is confirmed.

1. The inspection and maintenance of machinery/equipment should only be performed after measures to prevent falling or runaway of the driven objects have been confirmed.
2. When the product is to be removed, confirm that the safety measures as mentioned above are implemented and the power from any appropriate source is cut, and read and understand the specific product precautions of all relevant products carefully.
3. Before machinery/equipment is restarted, take measures to prevent unexpected operation and malfunction.

4. Contact SMC beforehand and take special consideration of safety measures if the product is to be used in any of the following conditions.

1. Conditions and environments outside of the given specifications, or use outdoors or in a place exposed to direct sunlight.
2. Installation on equipment in conjunction with atomic energy, railways, air navigation, space, shipping, vehicles, military, medical treatment, combustion and recreation, or equipment in contact with food and beverages, emergency stop circuits, clutch and brake circuits in press applications, safety equipment or other applications unsuitable for the standard specifications described in the product catalog.
3. An application which could have negative effects on people, property, or animals requiring special safety analysis.
4. Use in an interlock circuit, which requires the provision of double interlock for possible failure by using a mechanical protective function, and periodical checks to confirm proper operation.

Caution

1. The product is provided for use in manufacturing industries.

The product herein described is basically provided for peaceful use in manufacturing industries.
If considering using the product in other industries, consult SMC beforehand and exchange specifications or a contract if necessary.
If anything is unclear, contact your nearest sales branch.

Limited warranty and Disclaimer/ Compliance Requirements

The product used is subject to the following “Limited warranty and Disclaimer” and “Compliance Requirements”.

Read and accept them before using the product.

Limited warranty and Disclaimer

1. The warranty period of the product is 1 year in service or 1.5 years after the product is delivered, whichever is first.*2)
Also, the product may have specified durability, running distance or replacement parts. Please consult your nearest sales branch.
2. For any failure or damage reported within the warranty period which is clearly our responsibility, a replacement product or necessary parts will be provided.
This limited warranty applies only to our product independently, and not to any other damage incurred due to the failure of the product.
3. Prior to using SMC products, please read and understand the warranty terms and disclaimers noted in the specified catalog for the particular products.

*2) **Vacuum pads are excluded from this 1 year warranty.**

A vacuum pad is a consumable part, so it is warranted for a year after it is delivered.
Also, even within the warranty period, the wear of a product due to the use of the vacuum pad or failure due to the deterioration of rubber material are not covered by the limited warranty.

Compliance Requirements

1. The use of SMC products with production equipment for the manufacture of weapons of mass destruction (WMD) or any other weapon is strictly prohibited.
2. The exports of SMC products or technology from one country to another are governed by the relevant security laws and regulations of the countries involved in the transaction. Prior to the shipment of a SMC product to another country, assure that all local rules governing that export are known and followed.

Caution

SMC products are not intended for use as instruments for legal metrology.

Measurement instruments that SMC manufactures or sells have not been qualified by type approval tests relevant to the metrology (measurement) laws of each country. Therefore, SMC products cannot be used for business or certification ordained by the metrology (measurement) laws of each country.

