

Fieldbus System

(Output device for driving 5-port solenoid valves)



Space-saving installation

Compact
Approx.
28 mm

Actual size



- **IP67**
* For units with a D-sub connector, and when connected to S0700 manifolds, it is IP40.
- **Drives up to 32 solenoids**
- **Daisy-chain wiring communication**
* Excludes the units compatible with IO-Link

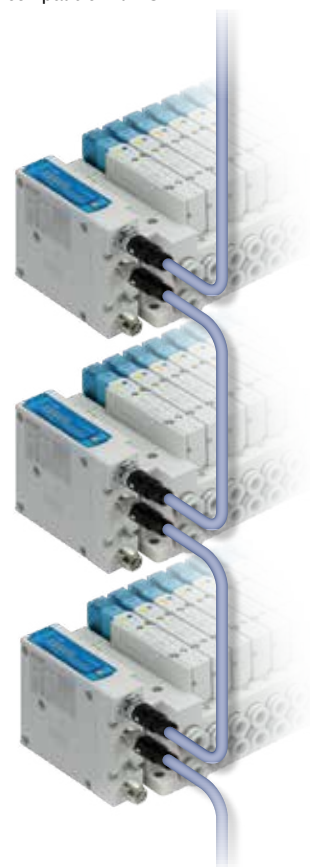

<Compatible Protocols>



Please contact SMC for details on compatible products.

New **IO-Link** compatible products have been added.

- Can be connected using a single cable
- Various types of diagnostic tests can be performed using service data.

Diagnostic contents	Internal failure of the SI unit	Output short circuit	Output open circuit
	Solenoid valve power supply failure	Abnormal internal temperature of the SI unit	Output switching count value exceeded



EX260 Series

NCE02-25C

Manifold length reduced by approx. 53 mm



Wiring and piping from the same direction is possible. (for side ported)

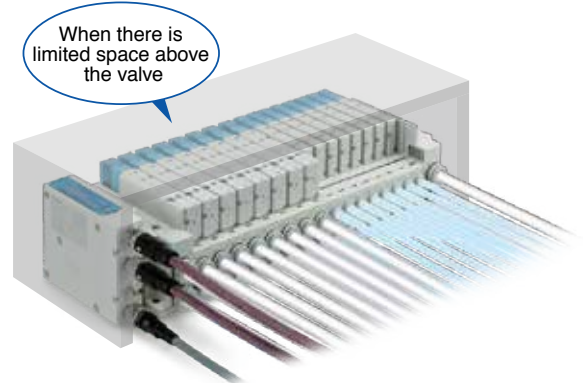

Daisy-chain wiring communication is possible.*1

A branch connector is not necessary/Reduced wiring space

*1 Excludes the units compatible with IO-Link

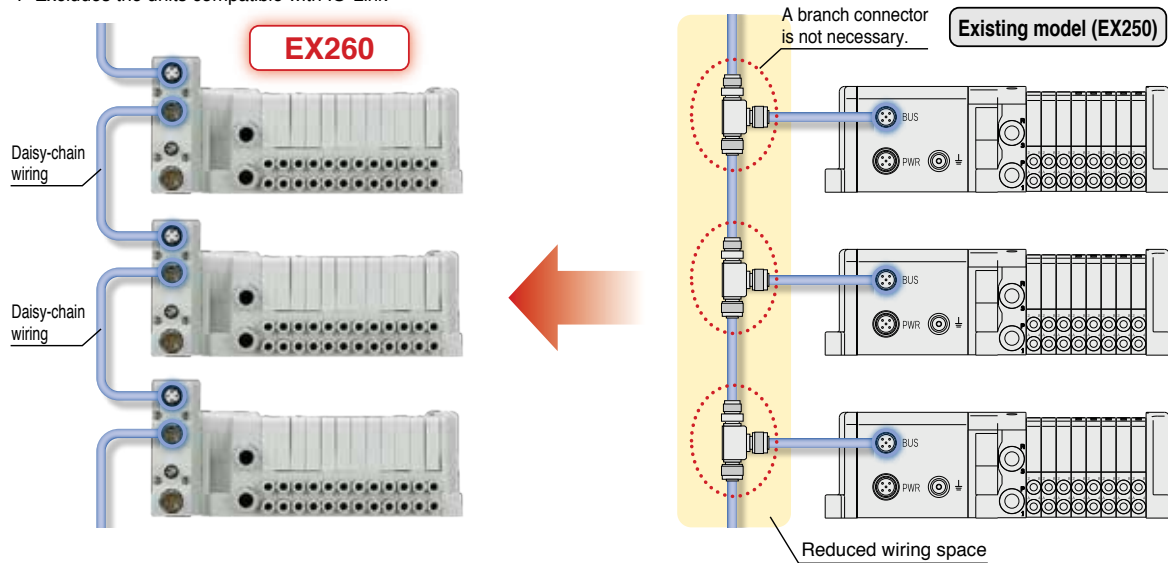

An external terminating resistor is not necessary.



(Only available for M12 PROFIBUS DP, CC-Link communication connectors)

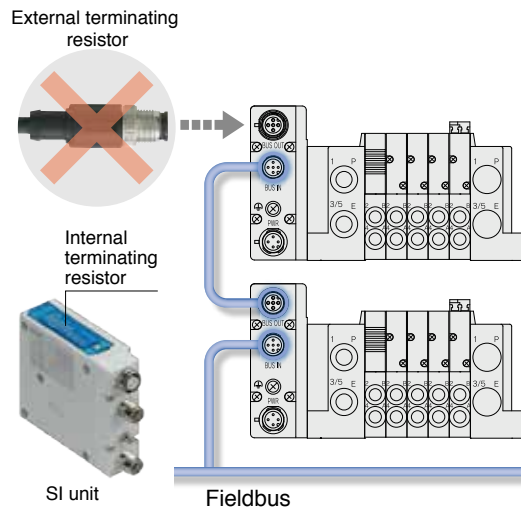







ON/OFF switching is possible with an internal terminating resistor.
An external terminating resistor is not necessary.



Fieldbus System (Output device for driving 5-port solenoid valves) *EX260 Series*

Product Specification Variations

			DeviceNet	CC-Link		EtherNet/IP	EtherCAT	ETHERNET POWERLINK	IO-Link
Number of outputs	16	●	●	●	●	●	●	●	
	32	●	●	●	●	●	●	●	●
Output polarity	PNP	●	●	●	●	●	●	●	●
	NPN	●	●	●	●	●	●	●	●
Communication connector	M12	●	●	●	●	●	●	●	●
	D-sub	●							

Applicable manifold	JSY Series	SY Series	SV Series	VQC Series	S0700 Series	SY Series	JSY Series	VQC Series
								

Communication connector examples



M12 communication connector x 2
(For daisy-chain wiring)











M12 communication connector x 1
(Same for the solenoid valve power supply wiring)

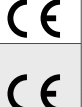

D-sub communication connector

Applicable Valve Series

Series	Flow rate characteristics (4/2 / 5/3)		Maximum number of solenoids	Power consumption [W]	Applicable cylinder size		
	C [dm ³ /(s·bar)]	b					
 IP67 *1		SY3000	1.6	0.19	32 0.35 (Standard) 0.1 (With power-saving circuit)	ø50	
		SY5000	3.6	0.17		ø63	
		SY7000	5.9	0.20		ø80	
 IP67 *1, *3		JSY1000	0.91	0.48	32 0.2 (With power-saving circuit) 0.4 (Standard) 0.1 (With power-saving circuit)	ø40	
		JSY3000	2.77	0.27		ø50	
		JSY5000	6.59	0.22		ø80	
 IP40		S0700 *2	0.37	0.39	32	0.35	ø25
 IP67 *1		SV1000 *2	1.1	0.35	32	0.6	ø40
		SV2000 *2	2.4	0.18			ø63
		SV3000 *2	4.3	0.21			ø80
 IP67 *1		VQC1000	1.0	0.30	24	0.4 (Standard) 0.95 (Standard) 0.4 (Low-wattage type)	ø40
		VQC2000	3.2	0.30			ø63
		VQC4000	7.3	0.38			ø160
		VQC5000	17	0.31			ø180

*1 Units with a D-sub communication connector are IP40.
 *2 There is no manifold part number setting for the IO-Link compatible units.
 *3 IP40 for the JSY1000

New IO-Link compatible

Integratable with various existing networks

IO-Link devices can be easily connected to various networks via the IO-Link master, which acts as a gateway between IO-Link communication and various Fieldbusses. Solenoid valves can be connected for communication without relying upon a Fieldbus or PLC.

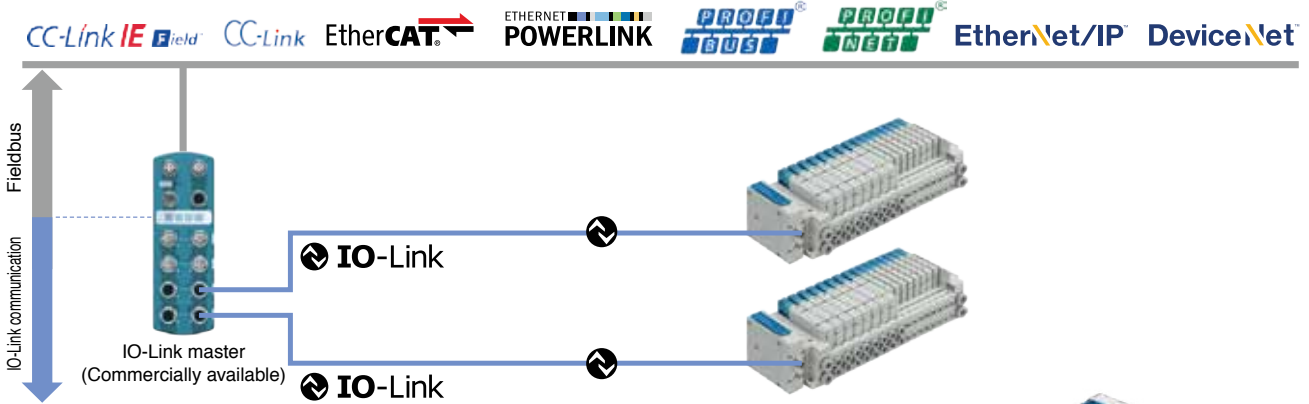

Can be connected using a single general-purpose cable, resulting in a reduction in the space required for wiring

Port class B
IO-Link master (Commercially available)

- Connect the IO-Link master port to the device using a 1:1 configuration.
- Connect using an M12 round connector.
- Maximum cable length: 20 m
- Special communication cables are not necessary.
- In order to connect the SI unit using a single cable, use a port class B type IO-Link master.



Port class B compliant

Port class A
IO-Link master (Commercially available)

General-purpose 5-wire unshielded cables are used for connection. The signal wire and valve power supply wire can be connected with the same cable.



SI unit/Connector pin arrangement

Pin no.	SI unit port pin function (Port class B)
1	+24 V for control unit
2	+24 V for solenoid valve
3	0 V for control unit
4	IO-Link communication
5	0 V for solenoid valve

Difference between IO-Link master port class A and class B

Pin no.	IO-Link master port pin function	
	Port class A	Port class B
1	+24 V	+24 V
2	NC/DI/DO	Additional power supply +24 V
3	0 V	0 V
4	IO-Link/DI/DO	IO-Link/DI/DO
5	NC	Additional power supply 0 V

Y Branch Connector

Port class A compliant
A special wiring Y branch connector is available.



Used when connecting to a port class A type IO-Link master, which is often used when connecting to an IO-Link sensor

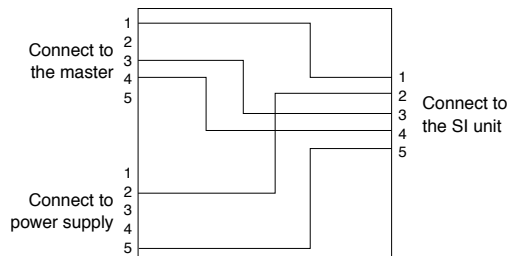

New IO-Link compatible

Features an impressive self-diagnosis function

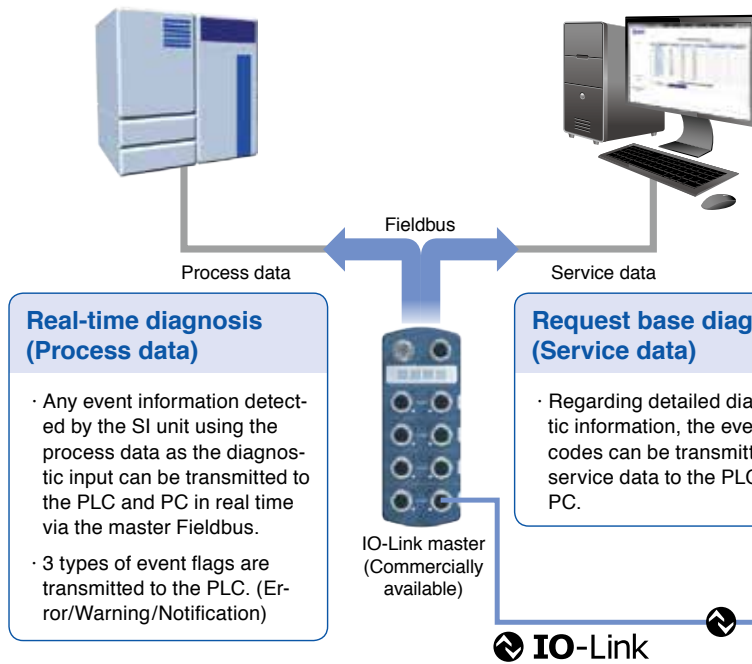

Self-diagnosis contents

Diagnostic contents	Event category
Internal failure of the SI unit	Error
Output short circuit	Error
Output open circuit	Error
Solenoid valve power supply failure	Warning
Abnormal internal temperature of the SI unit	Warning
Output switching count value exceeded	Notification

Equipped with a solenoid valve output operation count function

The number of valve operation instructions is counted for each output of the solenoid valve.

Set the count threshold value to be used as a guide for maintenance according to the operating conditions of the cylinder connected to the solenoid valve.



Once the threshold value is reached, notification of this fact will take place automatically.



This enables periodic maintenance to be performed before any unexpected cylinder failures occur.

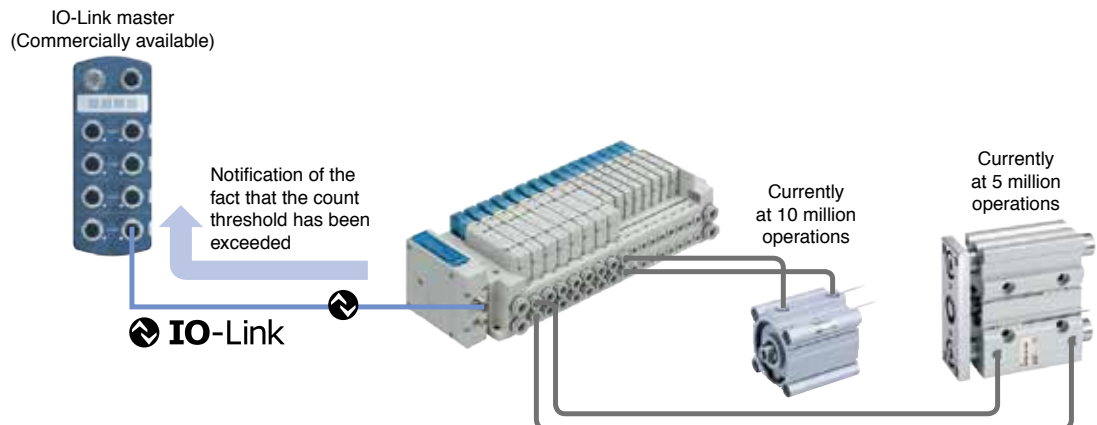

CONTENTS

Fieldbus System (Output device for driving 5-port solenoid valves) **EX260 Series**

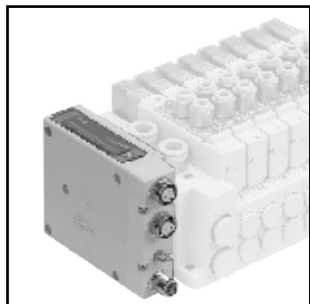

How to Order SI Units	p. 6
Specifications	p. 7
Dimensions	p. 8
Parts Description	p. 9
LED Indicator	p. 10

Accessories

① Communication Cable	p. 11
② Field-wireable Communication Connector	p. 17
③ Power Supply Cable (For SI unit)	p. 18
④ Power Supply Cable (For SI unit/For power block) ...	p. 19
⑤ Seal Cap (10 pcs.)	p. 19
⑥ Output Block	p. 20
⑦ Power Block	p. 20
⑧ Connector for Output Block Wiring	p. 21
⑨ End Plate	p. 21
⑩ Bracket Plate/DIN Rail Mounting Bracket	p. 21

Made to Order

SI Unit	
EtherNet/IP™ Web server function compatible	p. 22
Communication Cable	p. 22
Power Supply Cable	p. 23

Specific Product Precautions	p. 24
-------------------------------------------	-------

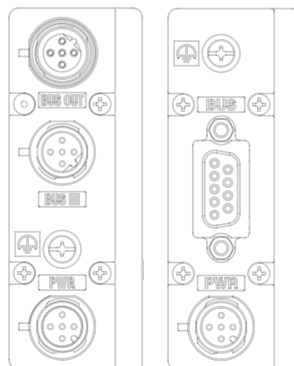
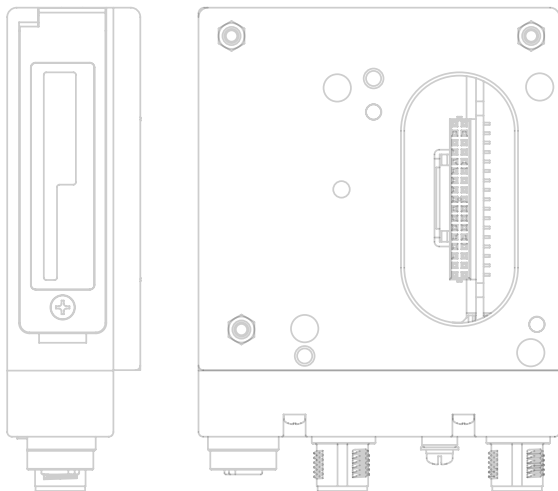



Compact design	Compact design for space saving
Number of outputs	32/16 digital output type available for each unit in the series (IO-Link is only compatible with the 32-point digital output type.)
Output polarity	Negative common (PNP)/positive common (NPN) type available for each unit in the series (Only negative common (PNP) is available for units compatible with Ethernet POWERLINK and IO-Link.)
Enclosure	IP67 (For units with a D-sub connector, and when connected with S0700 manifolds, it is IP40.)
Internal terminating resistor	ON/OFF switching is possible with an internal terminating resistor for communication. (Only for units compatible with M12 PROFIBUS DP, CC-Link communication connectors)

Applicable Manifold

SY3000/5000/7000	JSY1000/3000/5000	VQC1000/2000/4000/5000	S0700	SV1000/2000/3000
-------------------------	--------------------------	-------------------------------	--------------	-------------------------

How to Order SI Units

EX260 - S PR1

Communication protocol

Symbol	Protocol	Number of outputs	Output polarity	Communication connector	Manifold symbol	Applicable manifold
DN1	DeviceNet™	32	Source/PNP (Negative common)	M12	QAN	SY3000 SY5000 SY7000 JSY1000 JSY3000 JSY5000 VQC1000 VQC2000 VQC4000 VQC5000 S0700 SV1000 SV2000 SV3000
DN2			Sink/NPN (Positive common)		QA	
DN3		16	Source/PNP (Negative common)		QBN	
DN4			Sink/NPN (Positive common)		QB	
PR1	PROFIBUS DP	32	Source/PNP (Negative common)	M12	NAN	
PR2			Sink/NPN (Positive common)		NA	
PR3		16	Source/PNP (Negative common)		NBN	
PR4			Sink/NPN (Positive common)		NB	
PR5		32	Source/PNP (Negative common)		D-sub*1	NCN
PR6			Sink/NPN (Positive common)			NC
PR7		16	Source/PNP (Negative common)			NDN
PR8			Sink/NPN (Positive common)			ND
MJ1	CC-Link	32	Source/PNP (Negative common)	M12		VAN
MJ2			Sink/NPN (Positive common)			VA
MJ3		16	Source/PNP (Negative common)			VBN
MJ4			Sink/NPN (Positive common)			VB

Symbol	Protocol	Number of outputs	Output polarity	Communication connector	Manifold symbol	Applicable manifold
EC1	EtherCAT	32	Source/PNP (Negative common)	M12	DAN	SY3000 SY5000 SY7000 JSY1000 JSY3000 JSY5000 VQC1000 VQC2000 VQC4000 VQC5000 S0700 SV1000 SV2000 SV3000
EC2			Sink/NPN (Positive common)		DA	
EC3		16	Source/PNP (Negative common)		DBN	
EC4			Sink/NPN (Positive common)		DB	
PN1	PROFINET	32	Source/PNP (Negative common)	M12	FAN	
PN2			Sink/NPN (Positive common)		FA	
PN3		16	Source/PNP (Negative common)		FBN	
PN4			Sink/NPN (Positive common)		FB	
EN1	EtherNet/IP™	32	Source/PNP (Negative common)	M12	EAN	
EN2			Sink/NPN (Positive common)		EA	
EN3		16	Source/PNP (Negative common)		EBN	
EN4			Sink/NPN (Positive common)		EB	
PL1	Ethernet POWERLINK	32	Source/PNP (Negative common)	M12	GAN	
PL3		16			GBN	
IL1	IO-Link	32	Source/PNP (Negative common)	M12	KAN	SY3000/5000/7000 JSY1000/3000/5000 VQC1000/2000/4000/5000

*1 Enclosure is IP40 when the communication connector is D-sub.

Made to Order
Made to Order
 → p. 22

EtherNet/IP™ Web server function compatible

* For "How to Order Manifold Assembly," refer to the **Web Catalog** of each valve.

EX260 Series

Specifications

All SI Units Common Specifications

Power supply for control	Power supply voltage	21.6 to 26.4 VDC*1
	Internal current consumption	100 mA or less
Power supply for output	Power supply voltage	22.8 to 26.4 VDC
Environmental resistance	Enclosure	IP67*2
	Operating temperature range	-10 to +50°C
	Operating humidity range	35 to 85%RH (No condensation)
	Withstand voltage	500 VAC for 1 minute between terminals and housing
	Insulation resistance	10 MΩ or more (500 VDC measured via megohmmeter) between terminals and housing
Standards	CE marking (EMC directive/RoHS directive), UL (CSA) compliant	
Weight	200 g	
Accessories	Mounting screw	2 pcs.
	Seal cap (for M12 connector socket)	EX9-AWTS (1 pc.)*3

*1 To serve as the power supply for communication, the power supply voltages are 11 to 25 VDC for the EX260-SDN□ and 18 to 30 VDC for the EX260-SIL1.

*2 IP40 applies to EX260-SPR5/6/7/8.

*3 Not provided for EX260-SPR5/6/7/8

Model	EX260-SPR1/3	EX260-SPR2/4	EX260-SPR5/7	EX260-SPR6/8	EX260-SDN1/3	EX260-SDN2/4	EX260-SMJ1/3	EX260-SMJ2/4	
Applicable system	Protocol	PROFIBUS DP				DeviceNet™		CC-Link	
	Version*1	DP-V0				Volume1 (Edition 3.5) Volume3 (Edition 1.5)		Ver.1.10	
	Configuration file*3	GSD file				EDS file		CSP+ file	
I/O occupation area (Inputs/Outputs)	SPR1: 0/32 SPR3: 0/16	SPR2: 0/32 SPR4: 0/16	SPR5: 0/32 SPR7: 0/16	SPR6: 0/32 SPR8: 0/16	SDN1: 0/32 SDN3: 0/16	SDN2: 0/32 SDN4: 0/16	SMJ1: 32/32 SMJ3: 32/32 (1 station, remote I/O stations)	SMJ2: 32/32 SMJ4: 32/32 (1 station, remote I/O stations)	
Applicable function	—				QuickConnect™		—		
Communication speed	9.6 k/19.2 k/45.45 k/93.75 k/ 187.5 k/500 k/1.5 M/3 M/6 M/12 Mbps				125 k/250 k/500 kbps		156 k/625 k/ 2.5 M/5 M/10 Mbps		
Communication connector specification	M12			D-sub		M12			
Terminating resistor switch	Built-in			None			Built-in		
Output	Output type	Source/PNP (Negative common)	Sink/NPN (Positive common)	Source/PNP (Negative common)	Sink/NPN (Positive common)	Source/PNP (Negative common)	Sink/NPN (Positive common)	Source/PNP (Negative common)	Sink/NPN (Positive common)
	Number of outputs	SPR1: 32 points SPR3: 16 points	SPR2: 32 points SPR4: 16 points	SPR5: 32 points SPR7: 16 points	SPR6: 32 points SPR8: 16 points	SDN1: 32 points SDN3: 16 points	SDN2: 32 points SDN4: 16 points	SMJ1: 32 points SMJ3: 16 points	SMJ2: 32 points SMJ4: 16 points
	Load	Solenoid valve with surge voltage suppressor 24 VDC, 1.5 W or less (SMC)							
	Supplied voltage	24 VDC							
	Supplied current	SPR1: Max. 2.0 A SPR3: Max. 1.0 A	SPR2: Max. 2.0 A SPR4: Max. 1.0 A	SPR5: Max. 2.0 A SPR7: Max. 1.0 A	SPR6: Max. 2.0 A SPR8: Max. 1.0 A	SDN1: Max. 2.0 A SDN3: Max. 1.0 A	SDN2: Max. 2.0 A SDN4: Max. 1.0 A	SMJ1: Max. 2.0 A SMJ3: Max. 1.0 A	SMJ2: Max. 2.0 A SMJ4: Max. 1.0 A

Model	EX260-SEC1/3	EX260-SEC2/4	EX260-SPN1/3	EX260-SPN2/4	EX260-SEN1/3	EX260-SEN2/4	EX260-SPL1	EX260-SPL3	EX260-SIL1	
Applicable system	Protocol	EtherCAT*2		PROFINET*2		EtherNet/IP™*2		Ethernet POWERLINK*2		IO-Link
	Version*1	Conformance Test Record V.1.1		PROFINET Specification Version 2.2		Volume1 (Edition 3.17) Volume2 (Edition 1.18)		EPSS DS 301 Version 1.2.0		V1.1
	Configuration file*3	XML file		GSD file		EDS file		XDD file		IODD file
I/O occupation area (Inputs/Outputs)	SEC1: 0/32 SEC3: 0/16	SEC2: 0/32 SEC4: 0/16	SPN1: 0/32 SPN3: 0/16	SPN2: 0/32 SPN4: 0/16	SEN1: 16/32 SEN3: 16/16	SEN2: 16/32 SEN4: 16/16	16/32	16/16	0/32 16/32*4	
Applicable function	—		FSU, MRP		QuickConnect™, DLR		—		—	
Communication speed	100 Mbps*2				10 M/100 Mbps*2		100 Mbps*2		COM3/COM2*4	
Communication connector specification	M12									
Terminating resistor switch	None (Not required)									
Output	Output type	Source/PNP (Negative common)	Sink/NPN (Positive common)	Source/PNP (Negative common)	Sink/NPN (Positive common)	Source/PNP (Negative common)	Sink/NPN (Positive common)	Source/PNP (Negative common)		
	Number of outputs	SEC1: 32 points SEC3: 16 points	SEC2: 32 points SEC4: 16 points	SPN1: 32 points SPN3: 16 points	SPN2: 32 points SPN4: 16 points	SEN1: 32 points SEN3: 16 points	SEN2: 32 points SEN4: 16 points	32	16	32
	Load	Solenoid valve with surge voltage suppressor 24 VDC, 1.5 W or less (SMC)		Solenoid valve with surge voltage suppressor 24 VDC, 1.0 W or less (SMC)		Solenoid valve with surge voltage suppressor 24 VDC, 1.5 W or less (SMC)				
	Supplied voltage	24 VDC								
	Supplied current	SEC1: Max. 2.0 A SEC3: Max. 1.0 A	SEC2: Max. 2.0 A SEC4: Max. 1.0 A	SPN1: Max. 2.0 A SPN3: Max. 1.0 A	SPN2: Max. 2.0 A SPN4: Max. 1.0 A	SEN1: Max. 2.0 A SEN3: Max. 1.0 A	SEN2: Max. 2.0 A SEN4: Max. 1.0 A	Max. 2 A	Max. 1 A	Max. 2 A

*1 Please note that the version is subject to change.

*2 Use a CAT5 or higher transmission cable for EtherCAT, PROFINET, EtherNet/IP™, and Ethernet POWERLINK.

*3 The configuration file can be downloaded from the SMC website.

*4 A selection can be made using the setting switch.

Dimensions

M12 communication connector type

- For PROFIBUS DP For DeviceNet™
- For CC-Link For EtherCAT For PROFINET
- For EtherNet/IP™ For Ethernet POWERLINK

D-sub communication connector type
(EX260-SPR5/6/7/8)

- For PROFIBUS DP

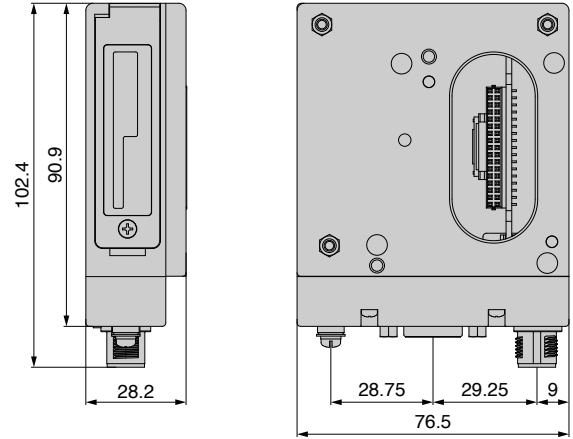
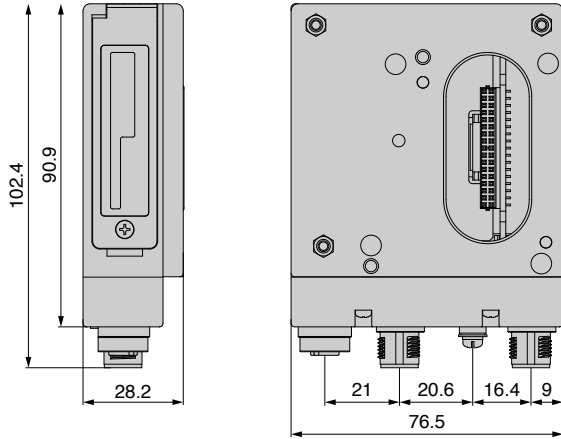

M12 communication connector type

- For IO-Link

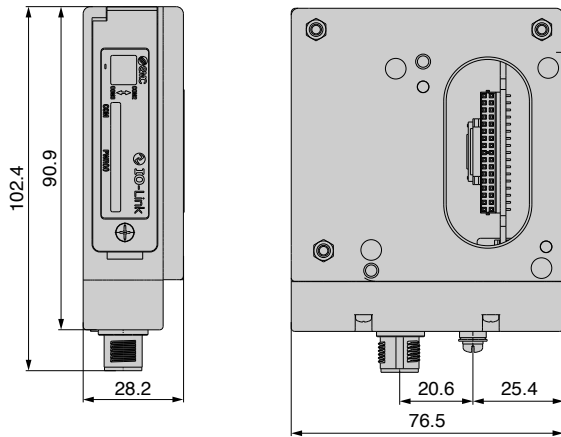

EX260 Series

Parts Description

For PROFIBUS DP

For DeviceNet™

For CC-Link

For EtherCAT

For PROFINET

For EtherNet/IP™

For Ethernet POWERLINK

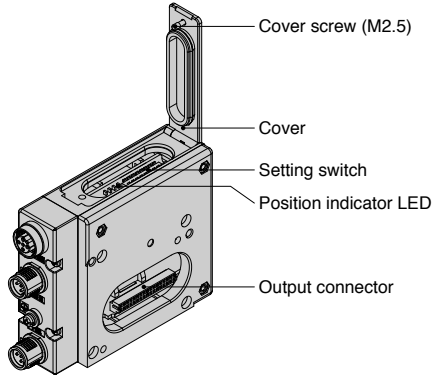

* The setting switch varies depending on the model. Refer to the operation manual for details. It can be downloaded via the SMC website.

<Connector>

M12 communication connector type



Part no.	EX260-SPR1/-SPR2 -SPR3/-SPR4	EX260-SDN□	EX260-SMJ□	EX260-SEC□ EX260-SPN□ EX260-SEN□ EX260-SPL□
Communication protocol	PROFIBUS DP	DeviceNet™	CC-Link	EtherCAT PROFINET EtherNet/IP™ Ethernet POWERLINK
Communication connector (M12) BUS OUT	5 pins, socket, B code (SPEEDCON)	5 pins, socket, A code (SPEEDCON)	5 pins, socket, A code* ¹ (SPEEDCON)	4 pins, socket, D code (SPEEDCON)
Communication connector (M12) BUS IN	5 pins, plug, B code (SPEEDCON)	5 pins, plug, A code (SPEEDCON)	4 pins, plug, A code (SPEEDCON)	4 pins, socket, D code (SPEEDCON)
Ground terminal	M3			
Power connector (M12)	5 pins, plug, A code (SPEEDCON)	4 pins, plug, A code (SPEEDCON)	5 pins, plug, B code (SPEEDCON)	5 pins* ² , 4 pins* ³ , plug, A code (SPEEDCON)

*1 Recommended mating M12 4-pin plug part no.: PCA-1567717
*2 For EtherCAT, PROFINET, and Ethernet POWERLINK
*3 For EtherNet/IP™

D-sub communication connector type

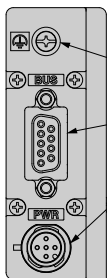

Part no.	EX260-SPR5/-SPR6/-SPR7/-SPR8
Communication protocol	PROFIBUS DP
Ground terminal	M3
Communication connector (D-sub) BUS IN/OUT	9 pins, socket
Power connector (M12)	5 pins, plug, A code

For IO-Link

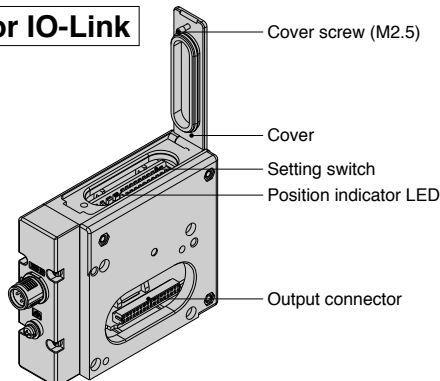

<Connector>

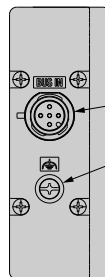

Part no.	EX260-SIL1
Communication protocol	IO-Link
Communication/ Power connector (M12)	5 pins, plug,* ¹ A code (SPEEDCON)
Ground terminal	M3

*1 The communication line, SI unit power supply line, and the solenoid valve power supply line are connected using the same cable.

* The setting switch varies depending on the model. Refer to the operation manual for details. It can be downloaded via the SMC website.

LED Indicator

For DeviceNet™

EX260-SDN□

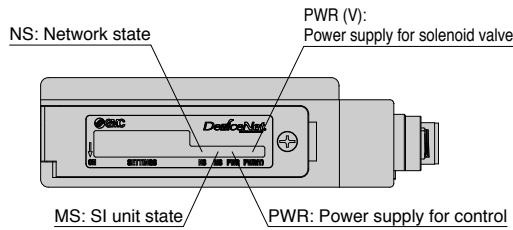

For EtherCAT

EX260-SEC□

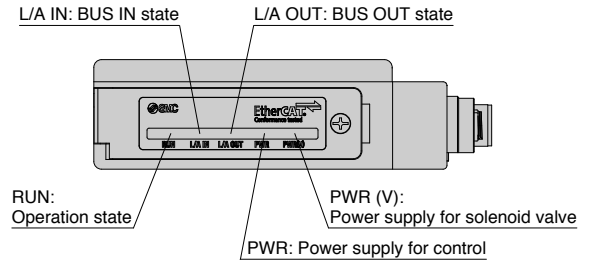

For EtherNet/IP™

EX260-SEN□

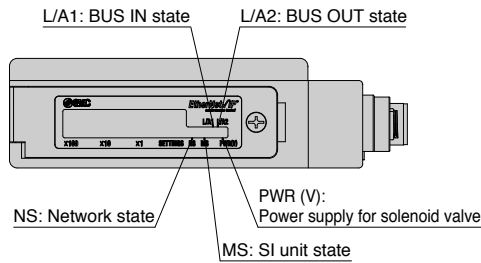

For CC-Link

EX260-SMJ□

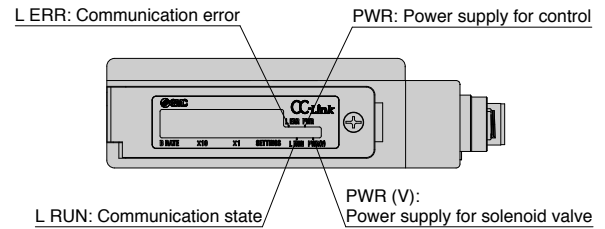

For PROFINET

EX260-SPN□

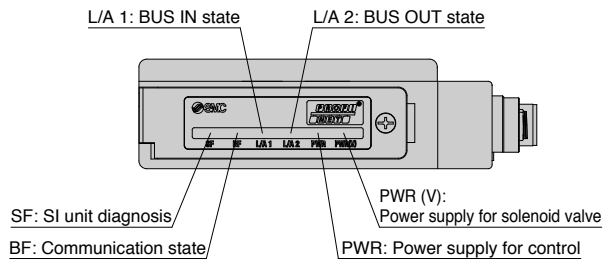

For PROFIBUS DP

EX260-SPR□

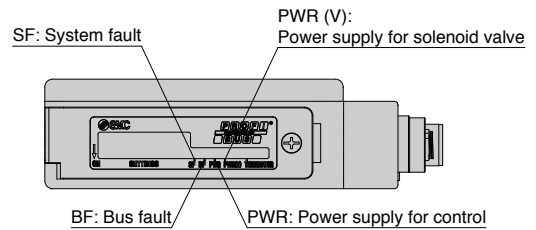

For Ethernet POWERLINK

EX260-SPL□

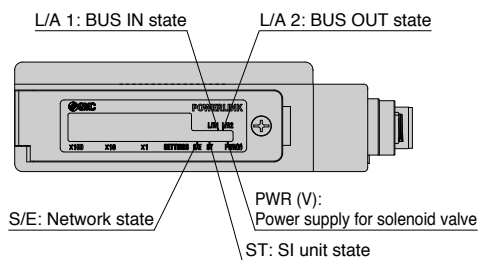

For IO-Link

EX260-SIL1

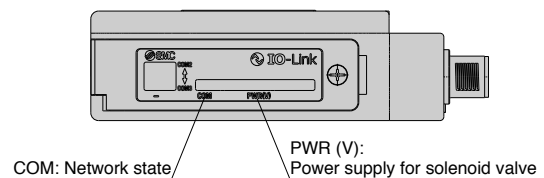

EX260 Series Accessories

① Communication Cable

For CC-Link

PCA-1567720
(Socket)

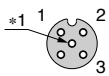

Socket connector pin arrangement
A-coded (Normal key)
*1 Number of holes: 5,
Total number of pins: 4

PCA-1567717
(Plug)



Plug connector pin arrangement
A-coded (Normal key)



Made to Order

Cable length	10000 mm	p. 22
--------------	----------	-------

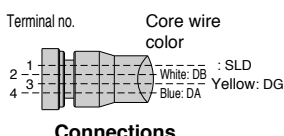
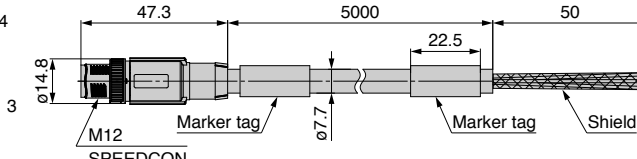
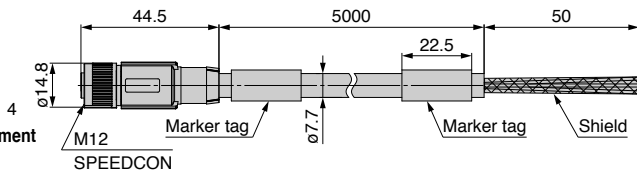

Item		Specifications
Cable O.D.		ø7.7 mm
Conductor nominal cross section	Data pair	0.5 mm ² /AWG20
	Drain	0.34 mm ² /AWG22
Wire O.D. (Including insulator)		2.55 mm
Min. bending radius (Fixed)		77 mm

EX9-AC 005 MJ-SSPS (With connector on both sides (Socket/Plug))

• Cable length (L)

005	500 mm
010	1000 mm
020	2000 mm
030	3000 mm
050	5000 mm
100	10000 mm

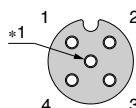
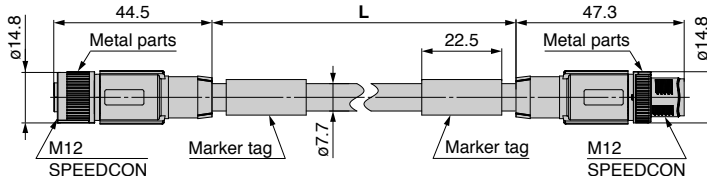

Socket connector pin arrangement
A-coded (Normal key)

*1 Number of holes: 5,
Total number of pins: 4

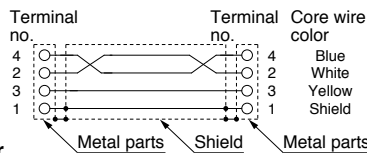

Connections

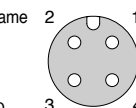

Plug connector pin arrangement
A-coded (Normal key)

Item		Specifications
Cable O.D.		ø7.7 mm
Conductor nominal cross section	Data pair	0.5 mm ² /AWG20
	Drain	0.34 mm ² /AWG22
Wire O.D. (Including insulator)		2.55 mm
Min. bending radius (Fixed)		77 mm

EX9-AC 005 MJ-SAPA (With angled connector on both sides (Socket/Plug))

• Cable length (L)

005	500 mm
010	1000 mm
020	2000 mm
030	3000 mm
050	5000 mm
100	10000 mm

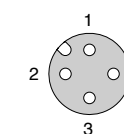
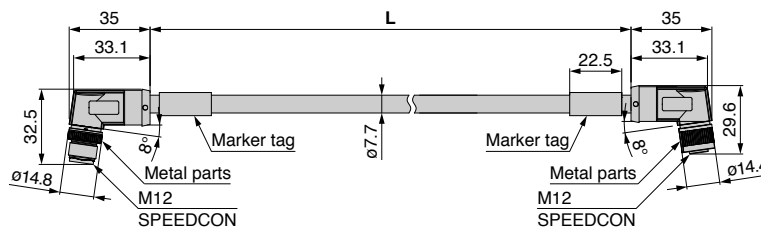

Plug connector pin arrangement
A-coded (Normal key)

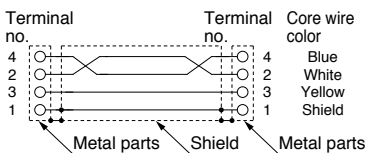

Connections

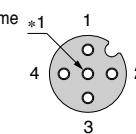

Socket connector pin arrangement
A-coded (Normal key)

*1 Number of holes: 5,
Total number of pins: 4

Item		Specifications
Cable O.D.		ø7.7 mm
Conductor nominal cross section	Data pair	0.5 mm ² /AWG20
	Drain	0.34 mm ² /AWG22
Wire O.D. (Including insulator)		2.55 mm
Min. bending radius (Fixed)		77 mm

① Communication Cable

For DeviceNet™

PCA-1557633
(Socket)

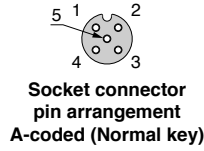

PCA-1557646
(Plug)

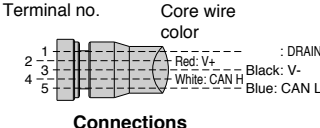
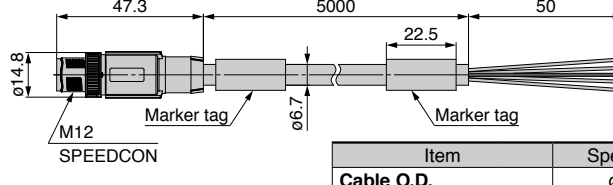
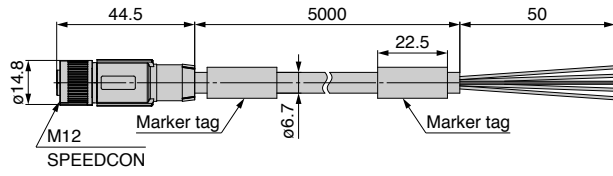
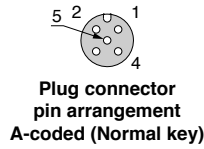

Item		Specifications
Cable O.D.		ø6.7 mm
Conductor nominal cross section	Power pair	0.34 mm ² /AWG22
	Data pair	0.25 mm ² /AWG24
Wire O.D. (Including insulator)	Power pair	1.4 mm
	Data pair	2.05 mm
Min. bending radius (Fixed)		67 mm



Made to Order

Cable length	10000 mm	p. 22
--------------	----------	-------

EX9-AC 005 DN-SSPS (With connector on both sides (Socket/Plug))

• Cable length (L)

005	500 mm
010	1000 mm
020	2000 mm
030	3000 mm
050	5000 mm
100	10000 mm

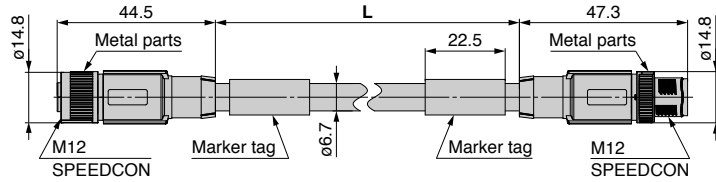

Item		Specifications
Cable O.D.		ø6.7 mm
Conductor nominal cross section	Power pair	0.34 mm ² /AWG22
	Data pair	0.25 mm ² /AWG24
Wire O.D. (Including insulator)	Power pair	1.4 mm
	Data pair	2.05 mm
Min. bending radius (Fixed)		67 mm

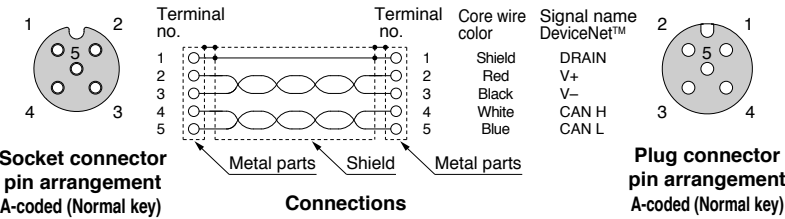

EX9-AC 005 DN-SAPA (With angled connector on both sides (Socket/Plug))

• Cable length (L)

005	500 mm
010	1000 mm
020	2000 mm
030	3000 mm
050	5000 mm
100	10000 mm

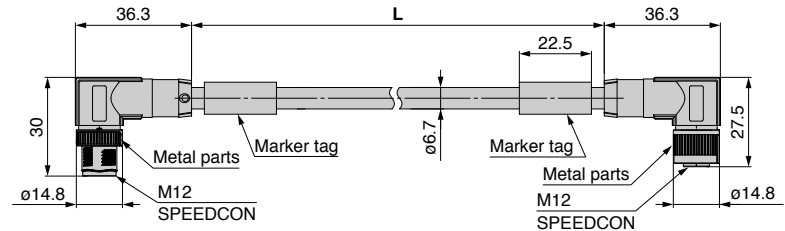

Item		Specifications
Cable O.D.		ø6.7 mm
Conductor nominal cross section	Power pair	0.34 mm ² /AWG22
	Data pair	0.25 mm ² /AWG24
Wire O.D. (Including insulator)	Power pair	1.4 mm
	Data pair	2.05 mm
Min. bending radius (Fixed)		67 mm

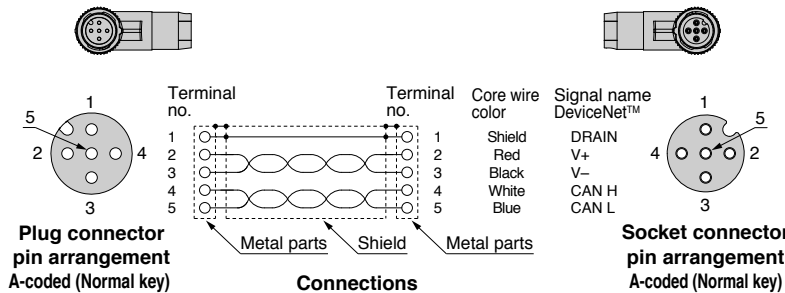

EX260 Series

① Communication Cable

For PROFIBUS DP

PCA-1557688
(Socket)

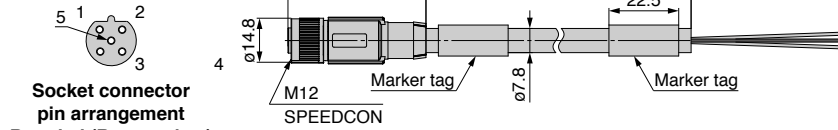

Socket connector
pin arrangement
B-coded (Reverse key)

PCA-1557691
(Plug)

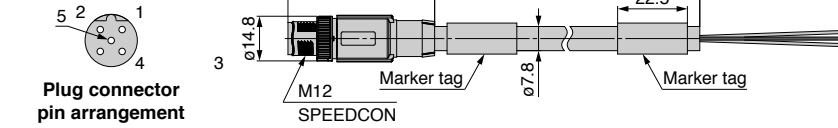

Plug connector
pin arrangement
B-coded (Reverse key)

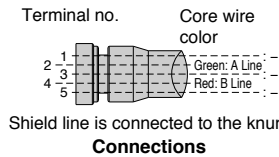

Item	Specifications
Cable O.D.	ø7.8 mm
Conductor nominal cross section	0.34 mm ² /AWG22
Wire O.D. (Including insulator)	2.55 mm
Min. bending radius (Fixed)	78 mm

For EtherCAT

For PROFINET

For EtherNet/IP™

For Ethernet POWERLINK

EX9-AC 020 EN-PSRJ (Plug/RJ-45 connector)

• Cable length (L)

010	1000 mm
020	2000 mm
030	3000 mm
050	5000 mm
100	10000 mm

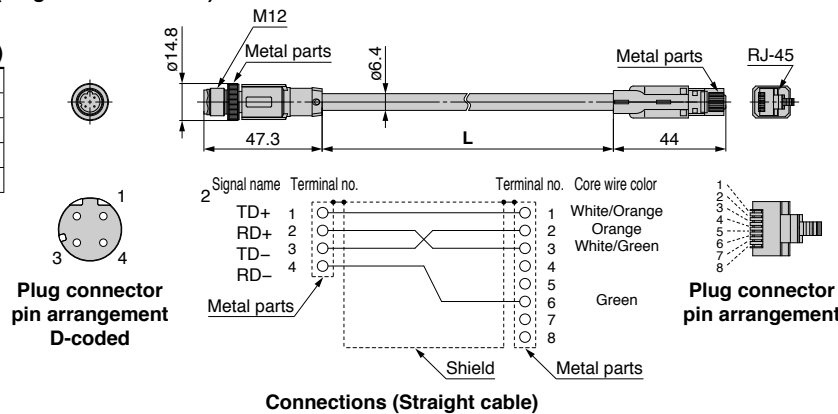

Item	Specifications
Cable O.D.	ø6.4 mm
Conductor nominal cross section	0.14 mm ² /AWG26
Wire O.D. (Including insulator)	0.98 mm
Min. bending radius (Fixed)	26 mm

PCA-1446566 (Plug)

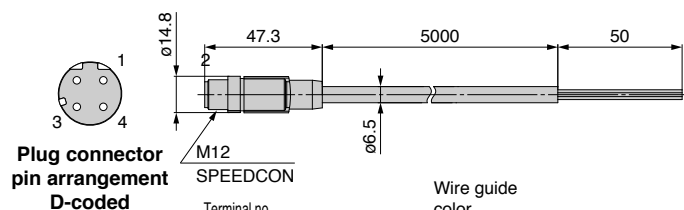

Plug connector
pin arrangement
D-coded

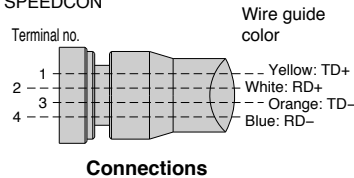

Item	Specifications
Cable O.D.	ø6.5 mm
Conductor nominal cross section	0.34 mm ² /AWG22
Wire O.D. (Including insulator)	1.55 mm
Min. bending radius (Fixed)	19.5 mm

① Communication Cable

For EtherCAT

For PROFINET

For EtherNet/IP™

For Ethernet POWERLINK

EX9-AC 005 EN-PSPS (With connector on both sides (Plug/Plug))

● Cable length (L)

005	500 mm
010	1000 mm
020	2000 mm
030	3000 mm
050	5000 mm
100	10000 mm

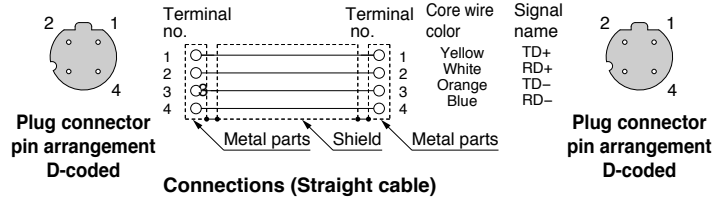
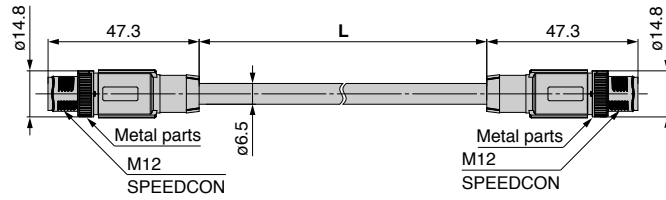

Item	Specifications
Cable O.D.	ø6.5 mm
Conductor nominal cross section	0.34 mm ² /AWG22
Wire O.D. (Including insulator)	1.55 mm
Min. bending radius (Fixed)	19.5 mm

EX9-AC 005 EN-PAPA (With angled connector on both sides (Plug/Plug))

● Cable length (L)

005	500 mm
010	1000 mm
020	2000 mm
030	3000 mm
050	5000 mm
100	10000 mm

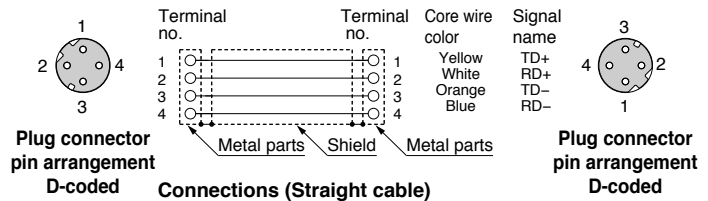
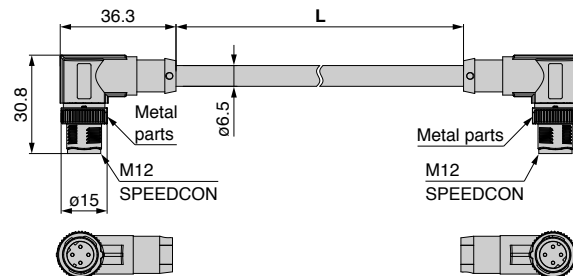

Item	Specifications
Cable O.D.	ø6.5 mm
Conductor nominal cross section	0.34 mm ² /AWG22
Wire O.D. (Including insulator)	1.55 mm
Min. bending radius (Fixed)	19.5 mm

EX260 Series

① Communication Cable

For IO-Link

Example of Connection

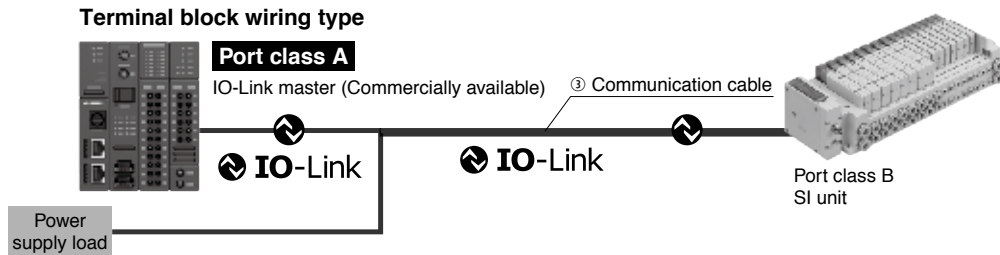
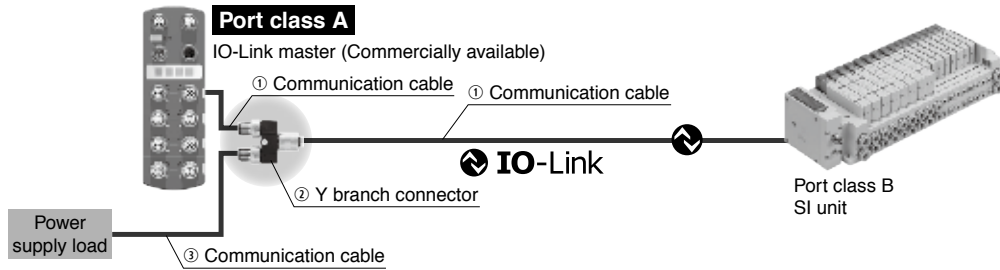
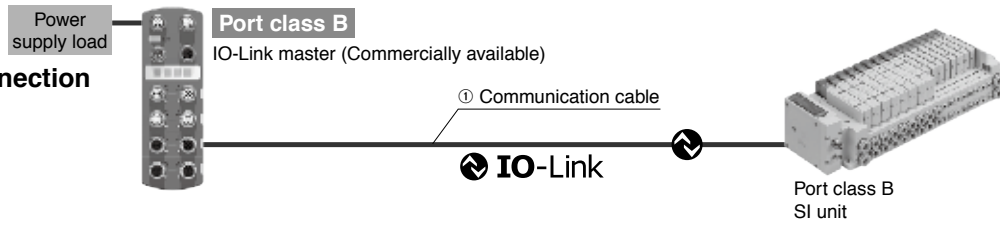

① Communication Cable

EX9-AC 005 -SSPS (With connector on both sides (Socket/Plug))

• Cable length (L)

005	500 mm
010	1000 mm
020	2000 mm
030	3000 mm
050	5000 mm
100	10000 mm

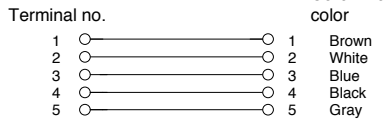
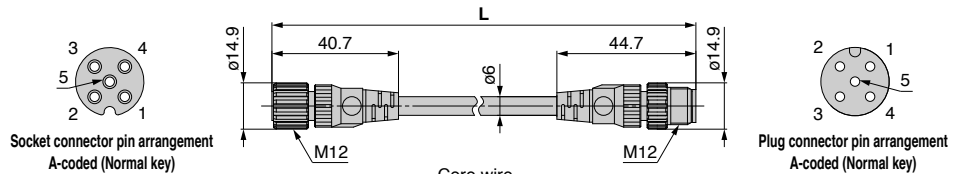

Connections

Item	Specifications
Cable O.D.	ø6 mm
Conductor nominal cross section	0.3 mm ² /AWG22
Wire O.D. (Including conductor)	1.5 mm
Min. bending radius (Fixed)	40 mm

EX9-AC 005 -SAPA (With connector on both sides (Socket/Plug))

• Cable length (L)

005	500 mm
010	1000 mm
020	2000 mm
030	3000 mm
050	5000 mm
100	10000 mm

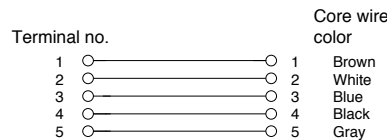
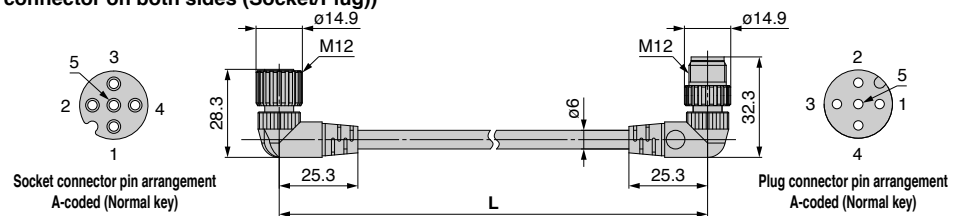

Connections

Item	Specifications
Cable O.D.	ø6 mm
Conductor nominal cross section	0.3 mm ² /AWG22
Wire O.D. (Including conductor)	1.5 mm
Min. bending radius (Fixed)	40 mm

① Communication Cable

For IO-Link

② Y branch connector

This connector is used to supply power to the valve manifold by branching the IO-Link communication cable in cases where a port class A IO-Link master is used.



EX9-ACY02-S

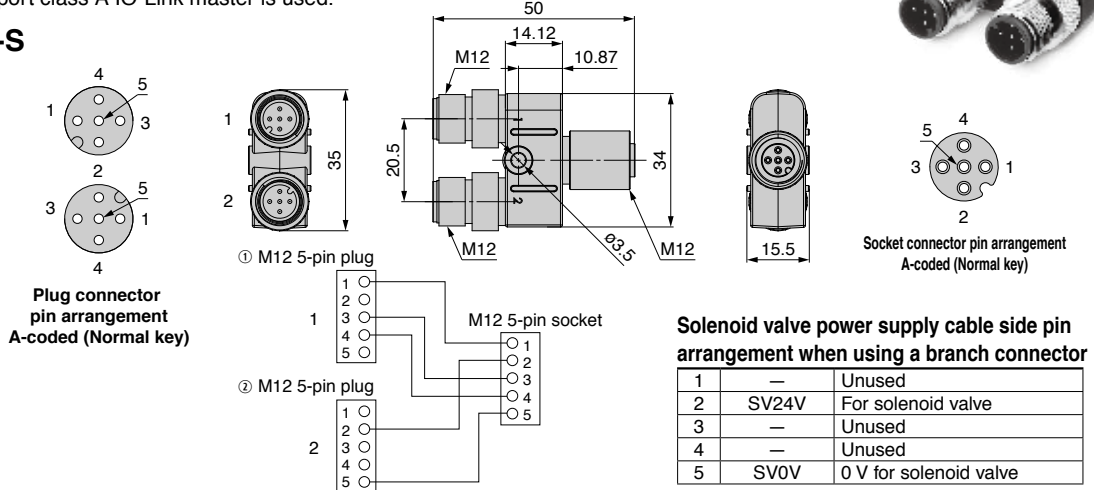

③ Communication cable

EX500-AP 050 - S

Cable length (L)

010	1000 mm
050	5000 mm

Connector specification

S	Straight
A	Angled

Straight connector type

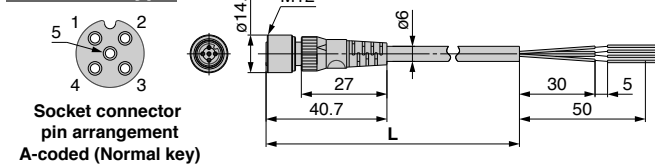

Item	Specifications
Cable O.D.	ø6 mm
Conductor nominal cross section	0.3 mm ² /AWG22
Wire O.D. (Including insulator)	1.5 mm
Min. bending radius (Fixed)	40 mm

Angled connector type

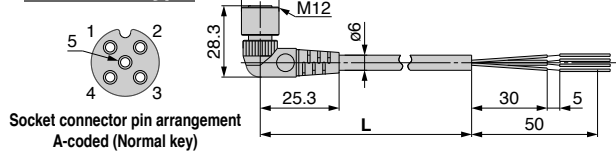

Item	Specifications
Cable O.D.	ø6 mm
Conductor nominal cross section	0.3 mm ² /AWG22
Wire O.D. (Including insulator)	1.5 mm
Min. bending radius (Fixed)	40 mm



Made to Order

Cable length	10000 mm	p. 23
--------------	----------	-------

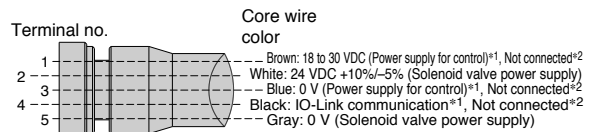

Connections (IO-Link)

*1 When used as an IO-Link communication cable
*2 When used as a solenoid valve power supply cable

PCA- 1401804

Cable length (L)

1401804	1500 mm
1401805	3000 mm
1401806	5000 mm

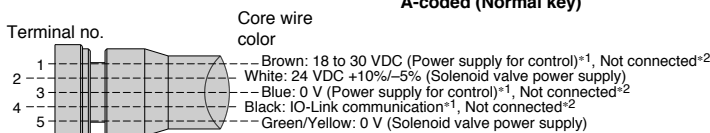
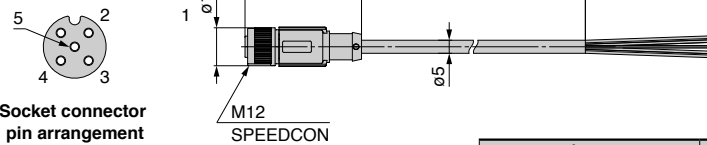

Item	Specifications
Cable O.D.	ø5 mm
Conductor nominal cross section	0.34 mm ² /AWG22
Wire O.D. (Including insulator)	1.27 mm
Min. bending radius (Fixed)	21.7 mm

Connections (IO-Link)

*1 When used as an IO-Link communication cable *2 When used as a solenoid valve power supply cable



EX260 Series

② Field-wireable Communication Connector

Plug

For CC-Link For DeviceNet™
PCA-1075526 PCA-1075528

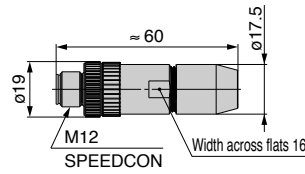

For PROFIBUS DP
PCA-1075530

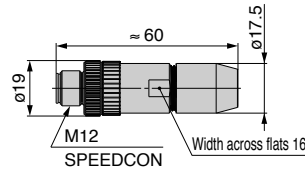

Applicable Cable

Item	Specifications
Cable O.D.	4.0 to 8.0 mm
Wire gauge (Stranded wire cross section)	0.14 to 0.75 mm ² /AWG26 to 18 (Solid cable/Flexible cable) 0.08 to 0.5 mm ² /AWG28 to 20 (With ferrule)

For EtherCAT For PROFINET For EtherNet/IP™ For Ethernet POWERLINK
PCA-1446553

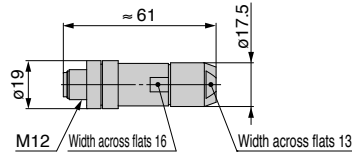
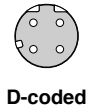

Applicable Cable

Item	Specifications
Cable O.D.	4.0 to 8.0 mm
Wire gauge (Stranded wire cross section)	0.14 to 0.34 mm ² /AWG26 to 22

* The table above shows the specifications for the applicable cable. Adaptation for the connector may vary on account of the conductor construction of the electric wire.

Socket

For CC-Link For DeviceNet™
PCA-1075527 PCA-1075529

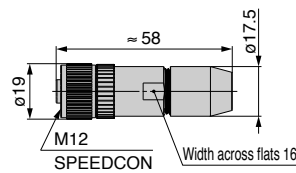

For PROFIBUS DP
PCA-1075531

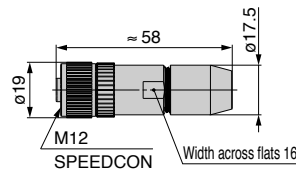

Applicable Cable

Item	Specifications
Cable O.D.	4.0 to 8.0 mm
Wire gauge (Stranded wire cross section)	0.14 to 0.75 mm ² /AWG26 to 18 (Solid cable/Flexible cable) 0.08 to 0.5 mm ² /AWG28 to 20 (With ferrule)

③ Power Supply Cable (For SI unit)

For PROFIBUS DP For DeviceNet™ For EtherCAT For PROFINET For EtherNet/IP™ For Ethernet POWERLINK

EX500-AP **050** - **S**

Cable length (L)

010	1000 mm
050	5000 mm

Connector specification

S	Straight
A	Angled

Straight connector type

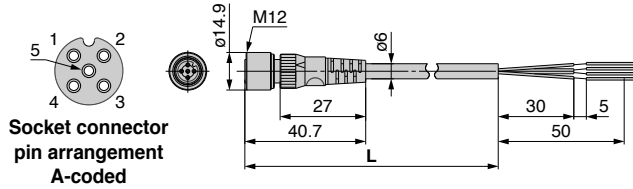

Item	Specifications
Cable O.D.	ø6 mm
Conductor nominal cross section	0.3 mm ² /AWG22
Wire O.D. (Including insulator)	1.5 mm
Min. bending radius (Fixed)	40 mm

Angled connector type

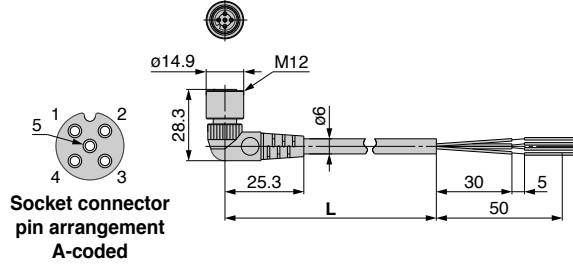

Item	Specifications
Cable O.D.	ø6 mm
Conductor nominal cross section	0.3 mm ² /AWG22
Wire O.D. (Including insulator)	1.5 mm
Min. bending radius (Fixed)	40 mm

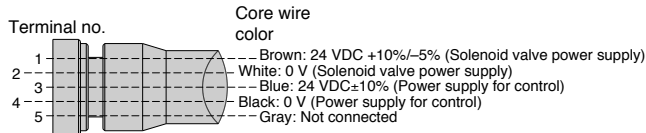

Connections (PROFIBUS DP/EtherCAT/PROFINET/Ethernet POWERLINK)

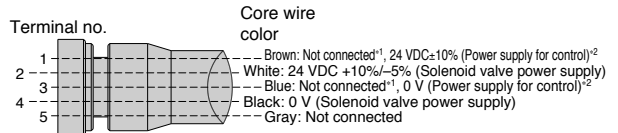

Connections (DeviceNet™, EtherNet/IP™) *1 For DeviceNet™ *2 For EtherNet/IP™



Made to Order

Cable length	10000 mm	p. 23
--------------	----------	-------

PCA- **1401804**

Cable length (L)

1401804	1500 mm
1401805	3000 mm
1401806	5000 mm

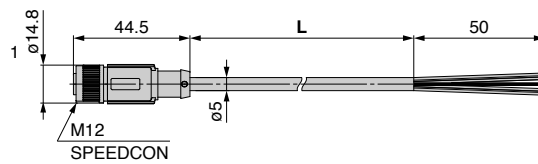
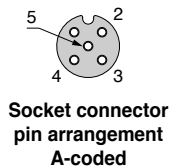

Item	Specifications
Cable O.D.	ø5 mm
Conductor nominal cross section	0.34 mm ² /AWG22
Wire O.D. (Including insulator)	1.27 mm
Min. bending radius (Fixed)	21.7 mm

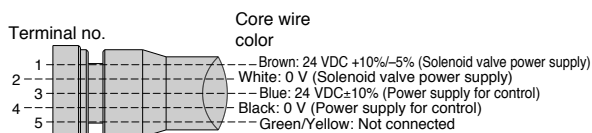

Connections (PROFIBUS DP/EtherCAT/PROFINET/Ethernet POWERLINK)

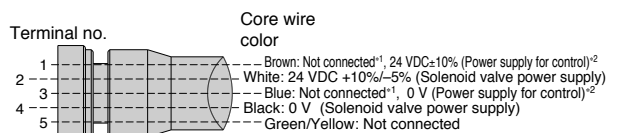

Connections (DeviceNet™, EtherNet/IP™) *1 For DeviceNet™ *2 For EtherNet/IP™

EX260 Series

④ Power Supply Cable (For SI unit/For power block)

For CC-Link For Power block

Straight connector type

EX9-AC 050 -1

● Cable length (L)

010	1000 mm
030	3000 mm
050	5000 mm

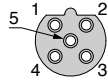

Socket connector pin arrangement B-coded

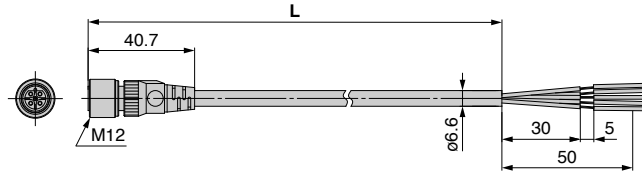

Item	Specifications
Cable O.D.	ø6.6 mm
Conductor nominal cross section	0.3 mm ² /AWG22
Wire O.D. (Including insulator)	1.65 mm
Min. bending radius (Fixed)	40 mm



Made to Order

Cable length	10000 mm	p. 23
--------------	----------	-------

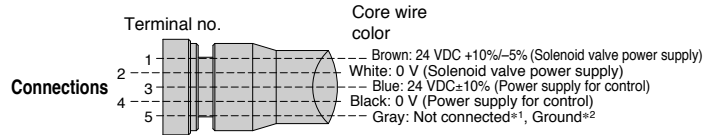

*1 For CC-Link
*2 For power block

PCA-1401807

● Cable length (L)

1401807	1500 mm
1401808	3000 mm
1401809	5000 mm

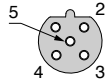

Socket connector pin arrangement B-coded

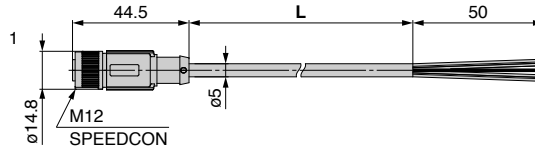

Item	Specifications
Cable O.D.	ø5 mm
Conductor nominal cross section	0.34 mm ² /AWG22
Wire O.D. (Including insulator)	1.27 mm
Min. bending radius (Fixed)	21.7 mm

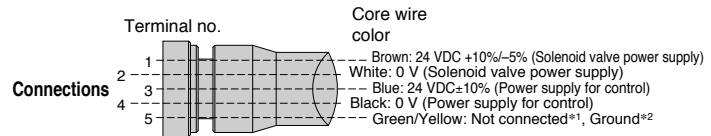

*1 For CC-Link
*2 For power block

⑤ Seal Cap (10 pcs.)

Use this on ports that are not being used for communication connector (M12 connector socket).
Use of this seal cap maintains the integrity of the IP67 enclosure.

* Tighten the seal cap with the prescribed tightening torque. (For M12: 0.1 N·m)

EX9-AW TS

● Connector specification

TS	For M12 connector socket (10 pcs.)
----	------------------------------------

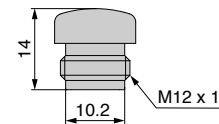
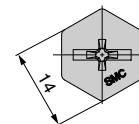

For M12 connector socket

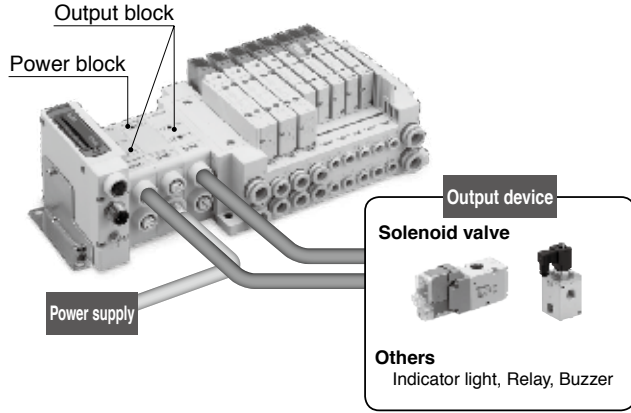

- Output devices other than valve manifold can be operated.
- By using the power block and output block for high watt load, operation up to 0.5 A/point can be performed.
- Possible to mount the output block and power block additionally between the SI unit and the solenoid valve (The surplus I/O points are used).
- 2 point outputs per output block (M12 connector)

You are requested to connect it to an SI unit and a valve manifold. For detailed specifications, refer to the operation manual that can be downloaded from SMC website.

⑥ Output Block

EX9-OE **T** **1**

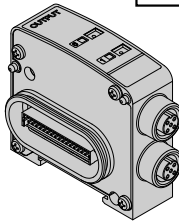

● Output specification

1	Source/PNP (Negative common)
2	Sink/NPN (Positive common)

● Power supply type

T	Internal power supply method (for low-wattage load)
P	Integrated power supply method (for high-wattage load) *1

*1 Required to connect with a power block

Dimensions/Parts Description

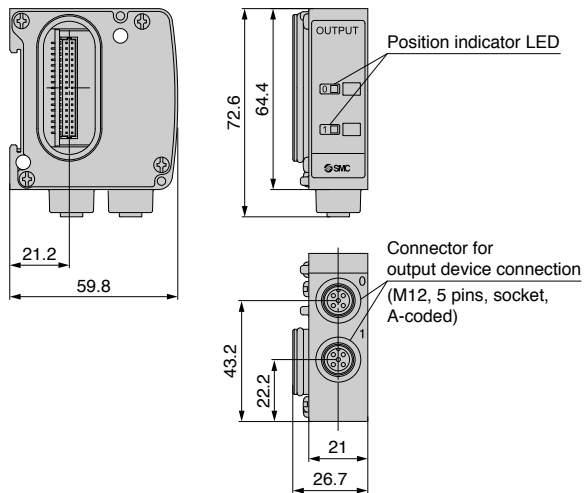

Specifications

Model	EX9-OET1	EX9-OET2	EX9-OEP1	EX9-OEP2	
Internal current consumption	40 mA or less				
Output	Output type	Source/PNP (Negative common)	Sink/NPN (Positive common)	Source/PNP (Negative common) Sink/NPN (Positive common)	
	Number of outputs	2 outputs			
	Power supply method	Internal power supply method		Integrated power supply method (Power block: supplied from EX9-PE1)	
	Output device supply voltage	24 VDC			
	Output device supply current	Max. 42 mA/point (1.0 W/point)		Max. 0.5 A/point (12 W/point)	
Environmental resistance	Enclosure	IP67			
	Operating temperature range	-10 to 50°C			
	Operating humidity range	35 to 85%RH (No condensation)			
Standards	CE marking (EMC directive/RoHS directive), UL (CSA)				
Weight	120 g				

⑦ Power Block

EX9-PE1

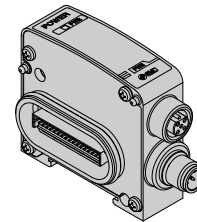

Dimensions/Parts Description

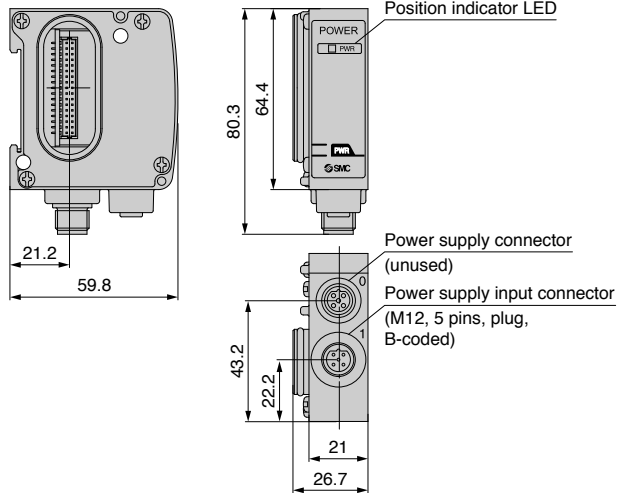

Specifications

Model	EX9-PE1	
Connection block	Output block for high wattage load	
Connection block stations	Output block: Max. 8 stations	
Power supply for output and internal control	Power supply voltage	22.8 to 26.4 VDC
	Internal current consumption	20 mA or less
Supply current	Max. 3.1 A*1	
Environmental resistance	Enclosure	IP67
	Operating temperature range	-10 to 50°C
	Operating humidity range	35 to 85%RH (No condensation)
Standards	CE marking (EMC directive/RoHS directive), UL (CSA)	
Weight	120 g	
Enclosed parts	Seal cap (for M12 connector) 1 pc.	

*1 When using with 3.0 to 3.1 A, the ambient temperature should not exceed 40°C, and do not bundle the cable.

EX260 Series

⑧ Connector for Output Block Wiring

Field-wireable connector for connecting an output device to an output block

PCA-1557743

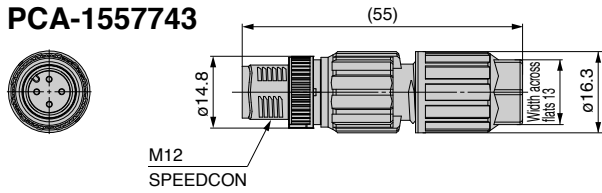

A-coded

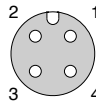

Plug pin arrangement

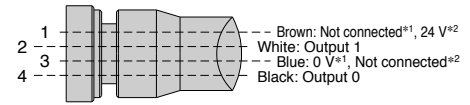

Connections

- *1 When used for EX9-OE□1
- *2 When used for EX9-OE□2

Applicable Cable

Item	Specifications
Cable O.D.	3.5 to 6.0 mm
Wire gauge (Stranded wire cross section)	0.14 to 0.34 mm ² /AWG26 to 22
Core wire diameter (Including insulating material)	0.7 to 1.3 mm

PCA-1557756

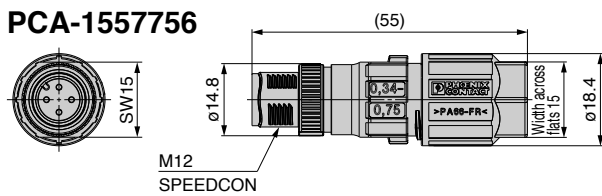

A-coded

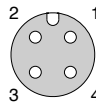

Plug pin arrangement

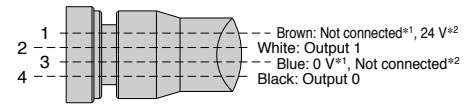

Connections

- *1 When used for EX9-OE□1
- *2 When used for EX9-OE□2

Applicable Cable

Item	Specifications
Cable O.D.	4.0 to 8.0 mm
Wire gauge (Stranded wire cross section)	0.34 to 0.75 mm ² /AWG22 to 18
Core wire diameter (Including insulating material)	1.3 to 2.5 mm

Refer to page 19 for the power supply cable for power block.

⑨ End Plate

Use when an output block is being used and a valve manifold is not connected.

EX9-EA03

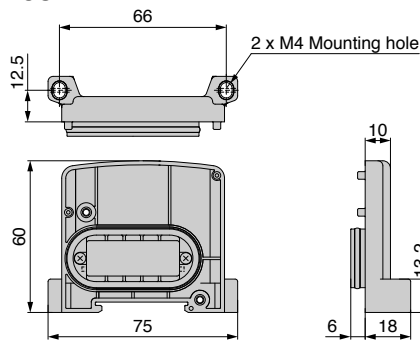

<Example of use>

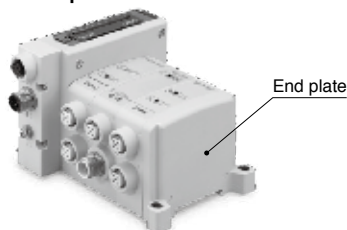

⑩ Bracket Plate/DIN Rail Mounting Bracket

A reinforcing brace used to mount an output block or power block onto an SI unit. To prevent connection failure between products due to deflection, use this bracket plate whenever an output block or power block is mounted.

EX9-BP1

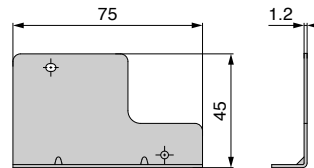
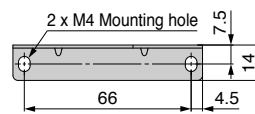

Accessory

Description	Qty.
Hexagon socket head cap screw (M3 x 35)	2

EX9-BD1

(For VQC, S0700, SV)

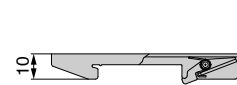
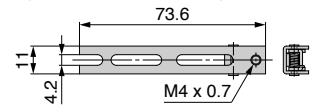

Accessory

Description	Qty.
Domed cap nut (M4)	1
Round head combination screw (M4 x 8)	1
Round head combination screw (M4 x 10)	1

<Example of use>

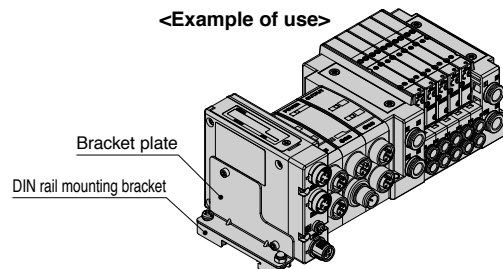

EX260 Series Made to Order

Please contact SMC for detailed specifications and lead times.



SI Unit

Prepare the SI unit and valve manifold (without SI unit) separately, and combine them before use.

EtherNet/IP™ Web server function compatible

EX260-SEN1-X194

- Web server compatible: Can conduct a solenoid valve operation test (ON/OFF), check communication state, set QuickConnect™, etc.
- Applicable to the power supply taken from Rockwell Automation's safe output module with pulse test function
- Compliant with QuickConnect™ class A specifications
- The gateway address is set to 192.168.□.001 when the IP address is set by the rotary switch.
- Dimensions are the same as those of the standard type.

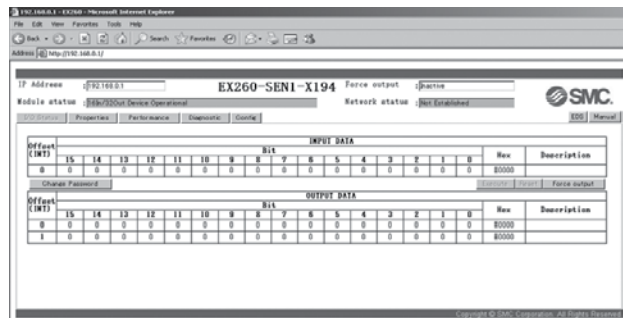

Web server screen (Example)

Communication Cable

With connector on one side (Socket)
Cable length: 10000 mm

For CC-Link

For CC-Link

For DeviceNet™

EX9-AC100 MJ -X12

• Applicable protocol

MJ	CC-Link
DN	DeviceNet™

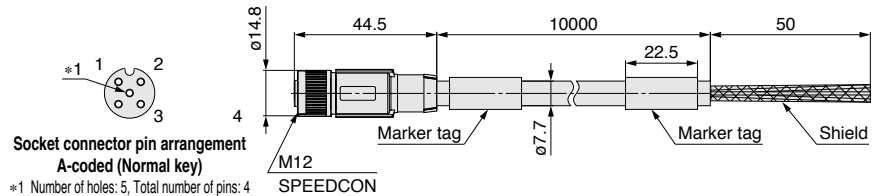

Socket connector pin arrangement
A-coded (Normal key)
*1 Number of holes: 5, Total number of pins: 4

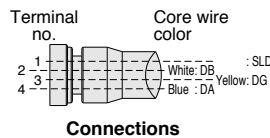

Connections

Item	Specifications
Cable O.D.	ø7.7 mm
Conductor nominal cross section	Data pair: 0.5 mm ² /AWG20 Drain: 0.34 mm ² /AWG22
Wire O.D. (Including insulator)	2.55 mm
Min. bending radius (Fixed)	77 mm

For DeviceNet™

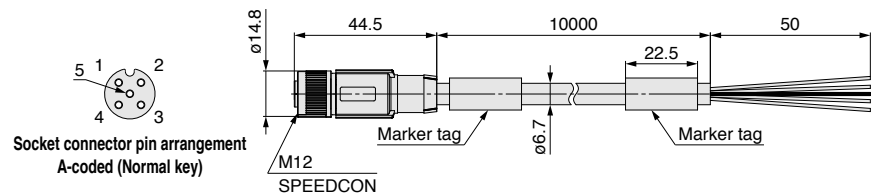

Socket connector pin arrangement
A-coded (Normal key)

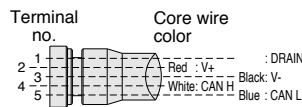

Connections

Item	Specifications
Cable O.D.	ø6.7 mm
Conductor nominal cross section	Power pair: 0.34 mm ² /AWG22 Data pair: 0.25 mm ² /AWG24
Wire O.D. (Including insulator)	Power pair: 1.4 mm Data pair: 2.05 mm
Min. bending radius (Fixed)	67 mm

EX260 Series

Power Supply Cable

① With connector on one side (Socket)

Cable length: 10000 mm

For CC-Link For Power block

EX9-AC100-1-X16

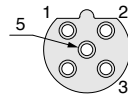
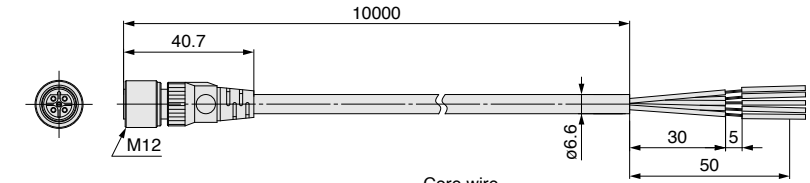

Socket connector pin arrangement B-coded (Reverse key)

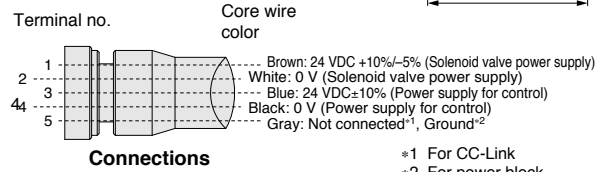

*1 For CC-Link
*2 For power block

Item	Specifications
Cable O.D.	ø6.6 mm
Conductor nominal cross section	0.3 mm ² /AWG22
Wire O.D. (Including insulator)	1.65 mm
Min. bending radius (Fixed)	40 mm

② With connector on one side (Socket)

Cable length: 10000 mm

For PROFIBUS DP For DeviceNet™ For EtherCAT For PROFINET For EtherNet/IP™

For Ethernet POWERLINK For IO-Link

EX500-AP100-**S**-X1

Connector specification

S	Straight
A	Angled

Straight connector type

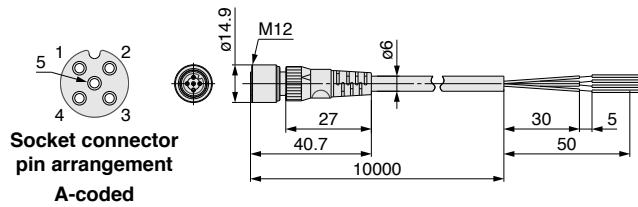

Item	Specifications
Cable O.D.	ø6 mm
Conductor nominal cross section	0.3 mm ² /AWG22
Wire O.D. (Including insulator)	1.5 mm
Min. bending radius (Fixed)	40 mm

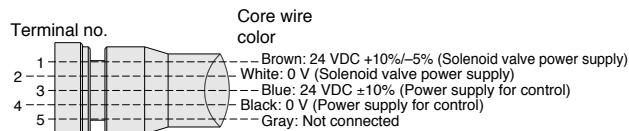

Connections (PROFIBUS DP/EtherCAT/PROFINET/Ethernet POWERLINK)

Angled connector type

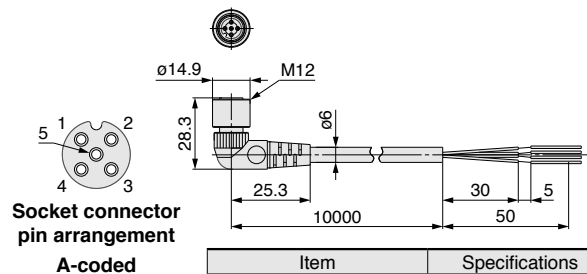

Item	Specifications
Cable O.D.	ø6 mm
Conductor nominal cross section	0.3 mm ² /AWG22
Wire O.D. (Including insulator)	1.5 mm
Min. bending radius (Fixed)	40 mm

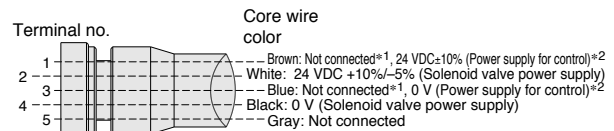

Connections (DeviceNet™, EtherNet/IP™) *1 For DeviceNet™ *2 For EtherNet/IP™

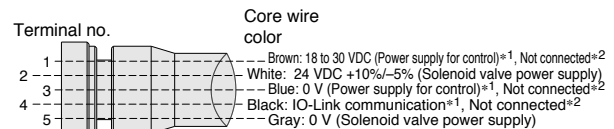

Connections (IO-Link) *1 When used as an IO-Link communication cable *2 When used as a solenoid valve power supply cable



EX260 Series Specific Product Precautions

Be sure to read this before handling the products. Refer to the back cover for safety instructions. For temperature control equipment precautions, refer to the “Handling Precautions for SMC Products” and the “Operation Manual” on SMC website.

Wiring

Caution

1. **Select connectors that are $\varnothing 16$ or less if mounting valve manifolds directly using field-wireable connectors for SI unit power supply wiring.**

Using large diameter connectors causes interference with the mounting surface.

The following cables with connectors are recommended.

■ **For EX260-SPR□/-SDN□/-SEC□/-SPN□/-SEN□/-SPL□**

<Cable with connector>

- EX500-AP□□□-□
- PCA-1401804/-1401805/-1401806

■ **For EX260-SMJ□**

<Cable with connector>

- EX9-AC□□□-1
- PCA-1401807/-1401808/-1401809

Adjustment / Operation

Caution

1. **For details on programming and address setting, refer to the manual from the PLC manufacturer.**

The content of programming related to protocol is designed by the manufacturer of the PLC used.

2. **For the EX260-SPN□, the side of the SI unit may become hot.**

It may cause burns.

Operating Environment

Caution

1. **Select the proper type of enclosure according to the operating environment.**

IP67 is achieved when the following conditions are met.

- 1) Provide appropriate wiring between all units using electrical wiring cables, communication connectors and cables with M12 connectors.
- 2) Appropriately mount each unit and valve manifold.
- 3) Be sure to mount a seal cap on any unused connectors.

If using in an environment that is exposed to water splashes, please take measures such as using a cover.

When the enclosure is IP40, do not use in an operating environment or atmosphere where it may come in contact with corrosive gas, chemical agents, seawater, water, or water vapor.

When connected to the EX260-SPR5/6/7/8, manifold enclosure is IP40.

■ **Trademark**

DeviceNet™ is a trademark of ODVA.

EtherNet/IP™ is a trademark of ODVA.

EtherCAT® is registered trademark and patented technology, licensed by Beckhoff Automation GmbH, Germany.

Modbus® is a registered trademark of Schneider Electric, licensed to the Modbus Organization, Inc.

QuickConnect™ is a trademark of ODVA.

Safety Instructions

These safety instructions are intended to prevent hazardous situations and/or equipment damage. These instructions indicate the level of potential hazard with the labels of “Caution,” “Warning” or “Danger.” They are all important notes for safety and must be followed in addition to International Standards (ISO/IEC)*1), and other safety regulations.

 **Caution:** Caution indicates a hazard with a low level of risk which, if not avoided, could result in minor or moderate injury.

 **Warning:** Warning indicates a hazard with a medium level of risk which, if not avoided, could result in death or serious injury.

 **Danger:** Danger indicates a hazard with a high level of risk which, if not avoided, will result in death or serious injury.

*1) ISO 4414: Pneumatic fluid power – General rules relating to systems.
ISO 4413: Hydraulic fluid power – General rules relating to systems.
IEC 60204-1: Safety of machinery – Electrical equipment of machines.
(Part 1: General requirements)
ISO 10218-1: Manipulating industrial robots – Safety.
etc.

Warning

1. The compatibility of the product is the responsibility of the person who designs the equipment or decides its specifications.

Since the product specified here is used under various operating conditions, its compatibility with specific equipment must be decided by the person who designs the equipment or decides its specifications based on necessary analysis and test results. The expected performance and safety assurance of the equipment will be the responsibility of the person who has determined its compatibility with the product. This person should also continuously review all specifications of the product referring to its latest catalog information, with a view to giving due consideration to any possibility of equipment failure when configuring the equipment.

2. Only personnel with appropriate training should operate machinery and equipment.

The product specified here may become unsafe if handled incorrectly. The assembly, operation and maintenance of machines or equipment including our products must be performed by an operator who is appropriately trained and experienced.

3. Do not service or attempt to remove product and machinery/equipment until safety is confirmed.

1. The inspection and maintenance of machinery/equipment should only be performed after measures to prevent falling or runaway of the driven objects have been confirmed.
2. When the product is to be removed, confirm that the safety measures as mentioned above are implemented and the power from any appropriate source is cut, and read and understand the specific product precautions of all relevant products carefully.
3. Before machinery/equipment is restarted, take measures to prevent unexpected operation and malfunction.

4. Contact SMC beforehand and take special consideration of safety measures if the product is to be used in any of the following conditions.

1. Conditions and environments outside of the given specifications, or use outdoors or in a place exposed to direct sunlight.
2. Installation on equipment in conjunction with atomic energy, railways, air navigation, space, shipping, vehicles, military, medical treatment, combustion and recreation, or equipment in contact with food and beverages, emergency stop circuits, clutch and brake circuits in press applications, safety equipment or other applications unsuitable for the standard specifications described in the product catalog.
3. An application which could have negative effects on people, property, or animals requiring special safety analysis.
4. Use in an interlock circuit, which requires the provision of double interlock for possible failure by using a mechanical protective function, and periodical checks to confirm proper operation.

Caution

1. The product is provided for use in manufacturing industries.

The product herein described is basically provided for peaceful use in manufacturing industries.
If considering using the product in other industries, consult SMC beforehand and exchange specifications or a contract if necessary.
If anything is unclear, contact your nearest sales branch.

Limited warranty and Disclaimer/ Compliance Requirements

The product used is subject to the following “Limited warranty and Disclaimer” and “Compliance Requirements”.

Read and accept them before using the product.

Limited warranty and Disclaimer

1. The warranty period of the product is 1 year in service or 1.5 years after the product is delivered, whichever is first.*2)
Also, the product may have specified durability, running distance or replacement parts. Please consult your nearest sales branch.
2. For any failure or damage reported within the warranty period which is clearly our responsibility, a replacement product or necessary parts will be provided.
This limited warranty applies only to our product independently, and not to any other damage incurred due to the failure of the product.
3. Prior to using SMC products, please read and understand the warranty terms and disclaimers noted in the specified catalog for the particular products.

*2) Vacuum pads are excluded from this 1 year warranty.

A vacuum pad is a consumable part, so it is warranted for a year after it is delivered.
Also, even within the warranty period, the wear of a product due to the use of the vacuum pad or failure due to the deterioration of rubber material are not covered by the limited warranty.

Compliance Requirements

1. The use of SMC products with production equipment for the manufacture of weapons of mass destruction (WMD) or any other weapon is strictly prohibited.
2. The exports of SMC products or technology from one country to another are governed by the relevant security laws and regulations of the countries involved in the transaction. Prior to the shipment of a SMC product to another country, assure that all local rules governing that export are known and followed.

Caution

SMC products are not intended for use as instruments for legal metrology.

Measurement instruments that SMC manufactures or sells have not been qualified by type approval tests relevant to the metrology (measurement) laws of each country. Therefore, SMC products cannot be used for business or certification ordained by the metrology (measurement) laws of each country.

 **Safety Instructions** Be sure to read the “Handling Precautions for SMC Products” (M-E03-3) and “Operation Manual” before use.

Unit Conversions

	unit	conversion	result		unit	conversion	result
length	m	x 3.28	psi	pressure	MPa	x 145	psi
	mm	x 0.04	psi			kPa	÷ 6.895
mass	g	x 0.04	°F	temperature	°C	x1.8 then add 32	°F
volume	cm ³	÷ 16.387	ft-lb	torque	N·m	x 0.738	ft-lb
	L	x 61.024	lbf	force	N	÷ 4.448	lbf
speed	mm/s	÷ 25.4	cfm	flow	L/min	÷ 28.317	cfm

Global Manufacturing, Distribution and Service Network

Worldwide Subsidiaries

EUROPE

AUSTRIA
SMC Pneumatik GmbH (Austria)

BELGIUM
SMC Pneumatics N.V./S.A.

BULGARIA
SMC Industrial Automation Bulgaria EOOD

CROATIA
SMC Industrijska Automatika d.o.o.

CZECH REPUBLIC
SMC Industrial Automation CZ s.r.o.

DENMARK
SMC Pneumatik A/S

ESTONIA
SMC Pneumatics Estonia

FINLAND
SMC Pneumatics Finland OY

FRANCE
SMC Pneumatique S.A.

GERMANY
SMC Pneumatik GmbH

GREECE
SMC Hellas EPE

HUNGARY
SMC Hungary Ipari Automatizálási Kft.

IRELAND
SMC Pneumatics (Ireland) Ltd.

ITALY
SMC Italia S.p.A.

KAZAKHSTAN
LLP "SMC Kazakhstan"

LATVIA
SMC Pneumatics Latvia SIA

LITHUANIA
UAB "SMC Pneumatics"

NETHERLANDS
SMC Pneumatics B.V.

NORWAY
SMC Pneumatics Norway AS

POLAND
SMC Industrial Automation Polska Sp. z o.o.

ROMANIA
SMC Romania S.r.l.

RUSSIA
SMC Pneumatik LLC.

SLOVAKIA
SMC Priemyselna Automatizacia, Spol s.r.o.

SLOVENIA
SMC Industrijska Avtomatika d.o.o.

SPAIN / PORTUGAL
SMC España, S.A.

SWEDEN
SMC Pneumatics Sweden AB

SWITZERLAND
SMC Pneumatik AG

TURKEY
SMC Pnömatik Sanayi Ticaret ve Servis A.Ş.

UK
SMC Pneumatics (U.K.) Ltd.

ASIA / OCEANIA

AUSTRALIA
SMC Pneumatics (Australia) Pty. Ltd.

CHINA
SMC (China) Co., Ltd.
SMC Pneumatics (Guangzhou) Ltd.

HONG KONG
SMC Pneumatics (Hong kong) Ltd.

INDIA
SMC Pneumatics (India) Pvt. Ltd.

INDONESIA
PT. SMC Pneumatics Indonesia

JAPAN
Shoketsu SMC Corporation

MALAYSIA
SMC Pneumatics (S.E.A.) Sdn. Bhd.

NEW ZEALAND
SMC Pneumatics (N.Z.) Ltd.

PHILIPPINES
Shoketsu SMC Corporation

SINGAPORE
SMC Pneumatics (S.E.A.) Pte. Ltd.

SOUTH KOREA
SMC Pneumatics Korea Co., Ltd.

TAIWAN
SMC Pneumatics (Taiwan) Co., Ltd.

THAILAND
SMC (Thailand) Ltd.

UNITED ARAB EMIRATES
SMC Pneumatics Middle East FZE

VIETNAM
SMC Pneumatics (VN) Co., Ltd

AFRICA

SOUTH AFRICA
SMC Pneumatics (South Africa) Pty Ltd

NORTH, CENTRAL & SOUTH AMERICA

ARGENTINA
SMC Argentina S.A.

BOLIVIA
SMC Pneumatics Bolivia S.R.L.

BRAZIL
SMC Pneumáticos do Brasil Ltda.

CANADA
SMC Pneumatics (Canada) Ltd.

CHILE
SMC Pneumatics (Chile) S.A.

COLOMBIA
SMC Colombia Sucursal de SMC Chile, S.A.

MEXICO
SMC Corporation (Mexico) S.A. de C.V.

PERU
SMC Corporation Peru S.A.C.

USA
SMC Corporation of America

VENEZUELA
SMC Neumatica Venezuela S.A.

U.S. & Canadian Sales Offices

WEST

Austin
Dallas
Los Angeles
Phoenix
Portland
San Jose

CENTRAL

Chicago
Cincinnati
Cleveland
Detroit
Des Moines
Grand Rapids
Indianapolis
Kansas City
Milwaukee
Minneapolis
St. Louis

EAST

Albany
Atlanta
Birmingham
Boston
Charlotte
Knoxville
Nashville
New Jersey
Rochester
Tampa

CANADA

Vancouver
Toronto
Windsor
Montreal

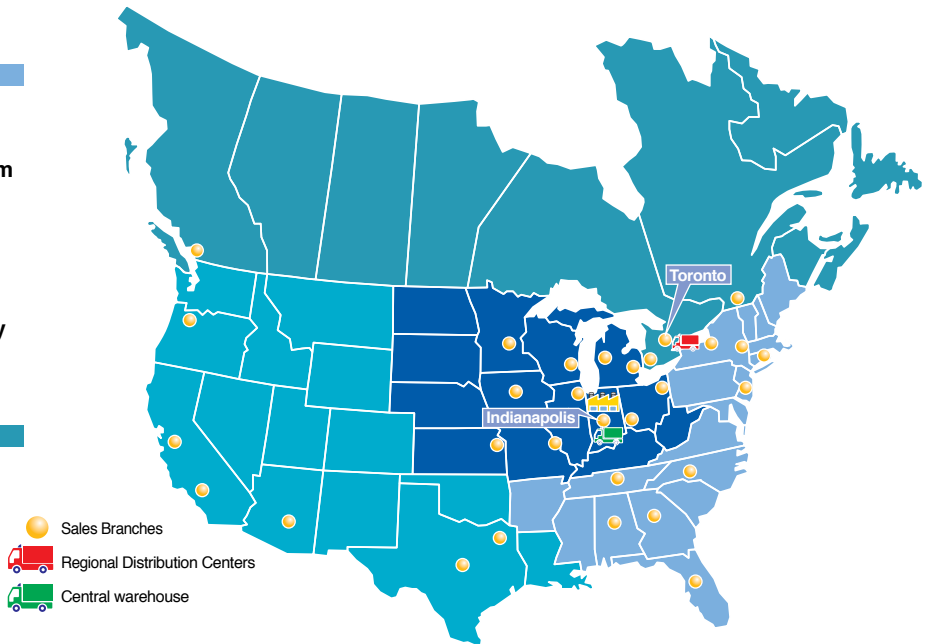

● Sales Branches
 Regional Distribution Centers
 Central warehouse

