

Electric Actuator Slide Table/ High Precision Type



Improved positioning repeatability due to the adoption of a ball screw drive.

Positioning repeatability **±0.01 mm**

Lost motion

0.1 mm or less

Increased vertical work load

5 times or more

	Size	8	16	25
New LESYH		6	12	20
Existing model LESH		0.5	2	4

Battery-less Absolute (Step Motor 24 VDC)

In-line motor type



Motor parallel type

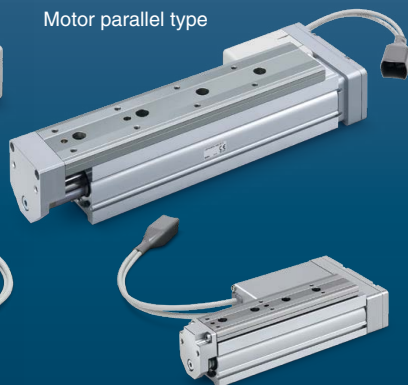

AC Servo Motor

Size	Motor output [W]
16	100
25	200

In-line motor type



Motor parallel type

Motorless Type Can be used with your current motor and driver!

Manufacturers of compatible motors: 18 companies

Mitsubishi Electric Corporation	YASKAWA Electric Corporation	SANYO DENKI CO., LTD.
OMRON Corporation	Panasonic Corporation	FANUC CORPORATION
NIDEC SANKYO CORPORATION	KEYENCE CORPORATION	FUJI ELECTRIC CO., LTD.
MinebeaMitsumi Inc.	Shinano Kenshi Co., Ltd.	ORIENTAL MOTOR Co., Ltd.
FASTECH Co., Ltd.	Rockwell Automation, Inc. (Allen-Bradley)	Beckhoff Automation GmbH
Siemens AG	Delta Electronics, Inc.	ANCA Motion



LESYH Series



P-E21-5

Battery-less Absolute Encoder Type

Restart from the last stop position is possible after recovery of the power supply.

The position information is held by the encoder even when the power supply is turned off. A return to origin operation is not necessary when the power supply is recovered.



Auto switches are mountable.

Mounting groove for auto switches

For checking the limit and the intermediate signal
Applicable to the D-M9□, D-M9□E, and D-M9□W (2-color indicator)

* The auto switches should be ordered separately. Refer to the **Web Catalog** for details.

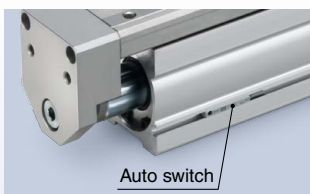

2-color indicator solid state auto switch

Accurate setting of the mounting position can be performed without mistakes.

A **green** light lights up when within the optimum operating range.

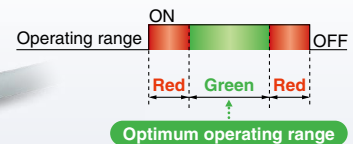

Motor mounting position

Select from 3 directions

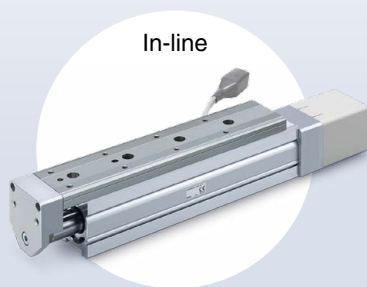

In-line

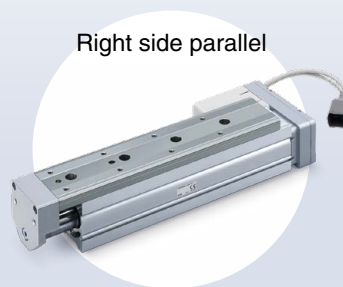

Right side parallel

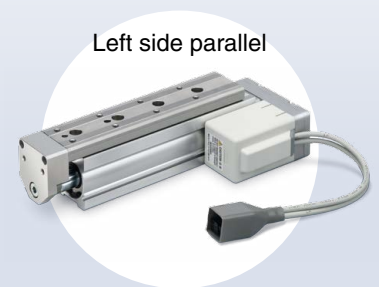

Left side parallel

Application examples

- For pick and place operations

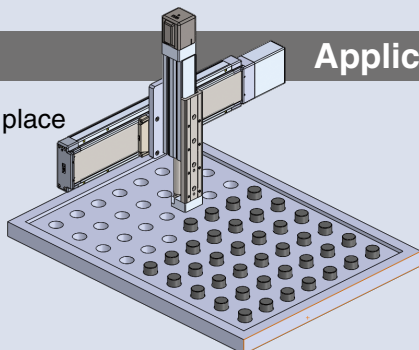

- For vertical transfer (Z axis)

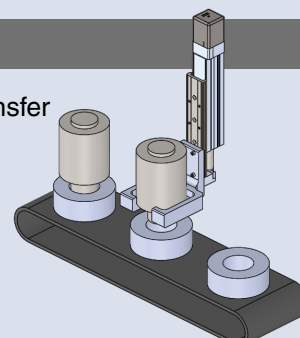

Model Selection



Selection Procedure

Positioning Control Selection Procedure



Selection Example

Step 1 Check the work load-speed. <Speed-Work load graph> (page 4)

Select a model based on the workpiece mass and speed while referencing the speed-work load graph. Selection example) The LESYH16□EB-50 can be temporarily selected as a possible candidate based on the graph shown on the right side.

Step 2 Check the cycle time.

Calculate the cycle time using the following calculation method.

Cycle time:

T can be found from the following equation.

$$T = T1 + T2 + T3 + T4 \text{ [s]}$$

- T1: Acceleration time and T3: Deceleration time can be found by the following equation.

$$T1 = V/a1 \text{ [s]} \quad T3 = V/a2 \text{ [s]}$$

- T2: Constant speed time can be found from the following equation.

$$T2 = \frac{L - 0.5 \cdot V \cdot (T1 + T3)}{V} \text{ [s]}$$

- T4: Settling time varies depending on the conditions such as motor types, load, and in position of the step data. Therefore, calculate the settling time while referencing the following value.

$$T4 = 0.15 \text{ [s]}$$

Calculation example)
T1 to T4 can be calculated as follows.

$$T1 = V/a1 = 200/3000 = 0.07 \text{ [s]}$$

$$T3 = V/a2 = 200/3000 = 0.07 \text{ [s]}$$

$$T2 = \frac{L - 0.5 \cdot V \cdot (T1 + T3)}{V} = \frac{50 - 0.5 \cdot 200 \cdot (0.07 + 0.07)}{200} = 0.18 \text{ [s]}$$

$$T4 = 0.15 \text{ [s]}$$

The cycle time can be found as follows.

$$T = T1 + T2 + T3 + T4 = 0.07 + 0.18 + 0.07 + 0.15 = 0.47 \text{ [s]}$$

Operating conditions

- Workpiece mass: 1 [kg]
- Workpiece mounting condition:
- Speed: 200 [mm/s]
- Mounting orientation: Vertical
- Stroke: 50 [mm]
- Acceleration/Deceleration: 3000 [mm/s²]
- Cycle time: 0.5 s

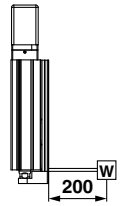

LESYH16□□/Step Motor Vertical

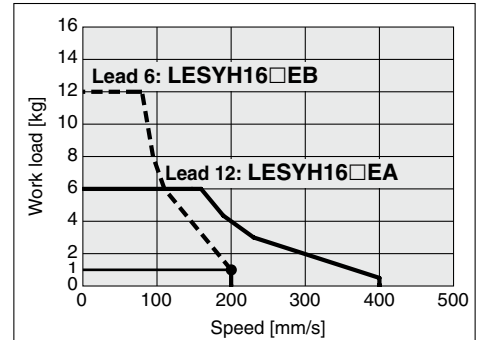

<Speed-Work load graph>

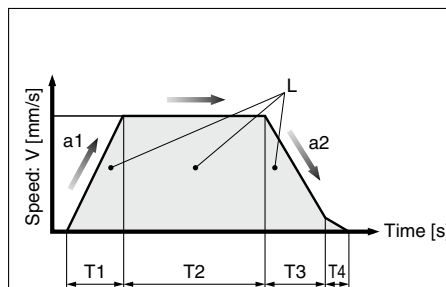

- L : Stroke [mm] (Operating condition)
- V : Speed [mm/s] (Operating condition)
- a1: Acceleration [mm/s²] ... (Operating condition)
- a2: Deceleration [mm/s²] ... (Operating condition)

- T1: Acceleration time [s] ... Time until reaching the set speed
- T2: Constant speed time [s] ... Time while the actuator is operating at a constant speed
- T3: Deceleration time [s] ... Time from the beginning of the constant speed operation to stop
- T4: Settling time [s] ... Time until positioning is completed

Step 3 Check the allowable moment.

<Static allowable moment> (page 4)

<Dynamic allowable moment> (pages 6, 7)

Confirm the moment that applies to the actuator is within the allowable range for both static and dynamic conditions.

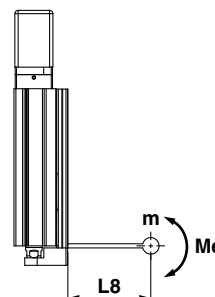

LESYH16/Pitching

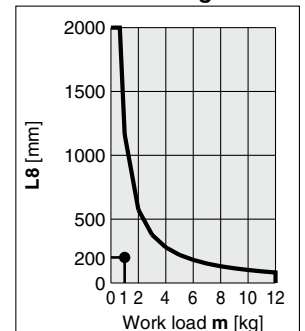

<Dynamic allowable moment>

Based on the above calculation result, the LESYH16□EB-50 should be selected.

Selection Procedure

Pushing Control Selection Procedure



Selection Example

Operating conditions

- Pushing force: 150 N
- Workpiece mass: 1 kg
- Speed: 100 mm/s
- Stroke: 100 mm
- Mounting position: Vertical upward
- Pushing time + Operation (A): 1.5 s
- Full cycle time (B): 10 s

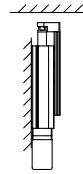

Step 1 Check the required force.

Calculate the approximate required force for a pushing operation.
 Selection example) • Pushing force: 150 [N]
 • Workpiece mass: 1 [kg]

The approximate required force can be found to be $150 + 10 = 160$ [N].

Select a model based on the approximate required force while referencing the specifications (page 27).

Selection example based on the specifications)

- Approximate required force: 160 [N]
- Speed: 100 [mm/s]

The LESYH16□EA can be temporarily selected as a possible candidate.

Then, calculate the required force for a pushing operation. If the mounting position is vertical upward, add the actuator table weight.

Selection example based on the table weight)

- LESYH16□EA table weight: 0.7 [kg]

The required force can be found to be $160 + 7 = 167$ [N].

Step 2 Check the pushing force.

<Pushing force set value–Force graph> (page 5)

Select a model based on the required force while referencing the pushing force set value–force graph, and confirm the pushing force set value.

Selection example based on the graph shown on the right side)

- Required force: 167 [N]
- The LESYH16□EA can be temporarily selected as a possible candidate.
- The pushing force set value is 64 [%].

Step 3 Check the duty ratio.

Confirm the allowable duty ratio based on the pushing force set value while referencing the allowable duty ratio.

Selection example based on the allowable duty ratio)

- Pushing force set value: 64 [%]
- The allowable duty ratio can be found to be 20 [%].

Calculate the duty ratio for the operating conditions, and confirm it does not exceed the allowable duty ratio.

Selection example) • Pushing time + Operation (A): 1.5 s

- Full cycle time (B): 10 s

The duty ratio can be found to be $1.5/10 \times 100 = 15$ [%], and this is within the allowable range.

Step 4 Check the allowable moment.

<Static allowable moment> (page 4)

<Dynamic allowable moment> (pages 6, 7)

Confirm the moment that applies to the actuator is within the allowable range for both static and dynamic conditions.

Table Weight

Unit [kg]

Model	Stroke [mm]			
	50	75	100	150
LESYH8	0.2	0.3	—	—
LESYH16	0.4	—	0.7	—
LESYH25	0.9	—	1.3	1.7

* If the mounting position is vertical upward, add the table weight.

LESYH16□E□/Battery-less Absolute

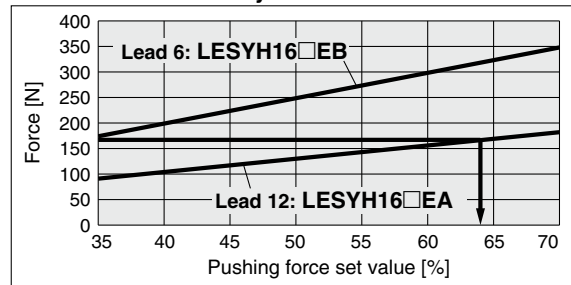

<Pushing force set value–Force graph>

Allowable Duty Ratio

Step Motor (Servo 24 VDC)

Pushing force set value [%]	Duty ratio [%]	Continuous pushing time [min]
35	—	—
50 or less	30 or less	5 or less
70 or less	20 or less	3 or less

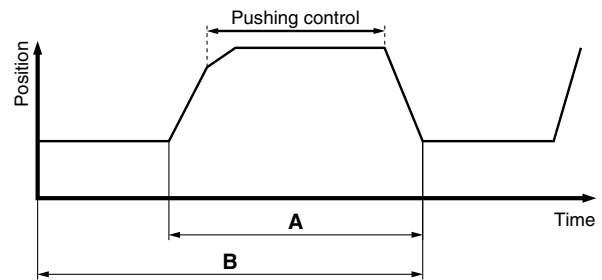

LESYH16/Pitching

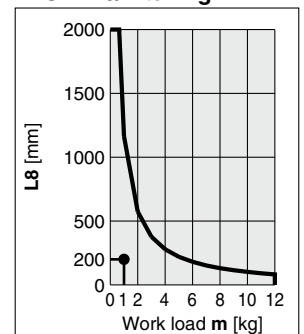

<Dynamic allowable moment>

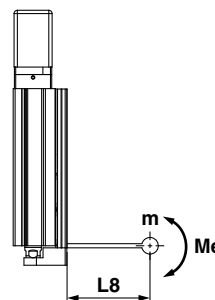

Based on the above calculation result, the LESYH16□EA-100 should be selected.

Speed-Work Load Graph (Guide)

LESYH8□E

Horizontal

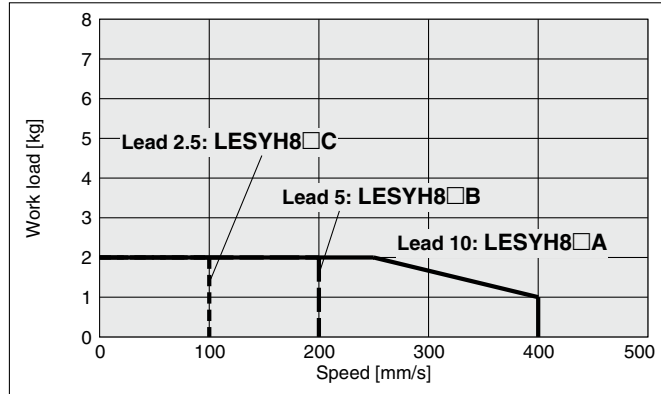

Vertical

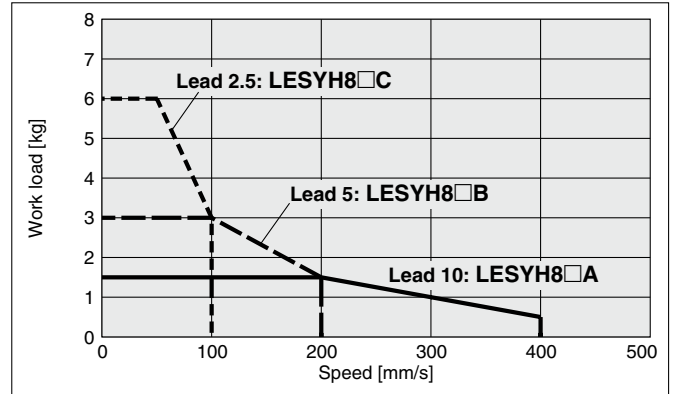

LESYH16□E

Horizontal

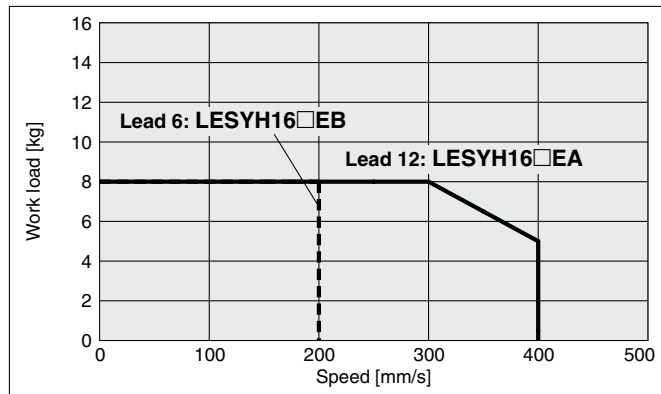

Vertical

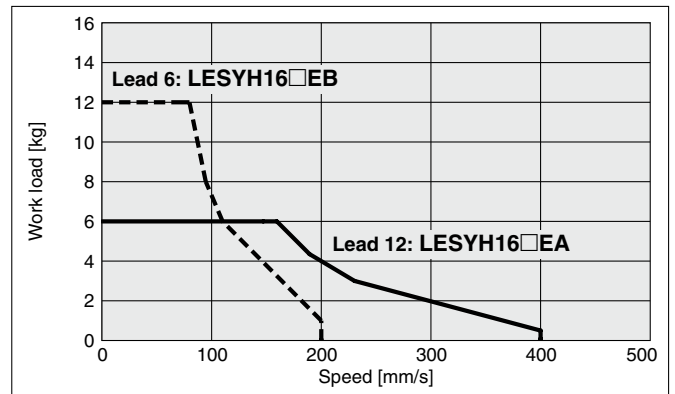

LESYH25□E

Horizontal

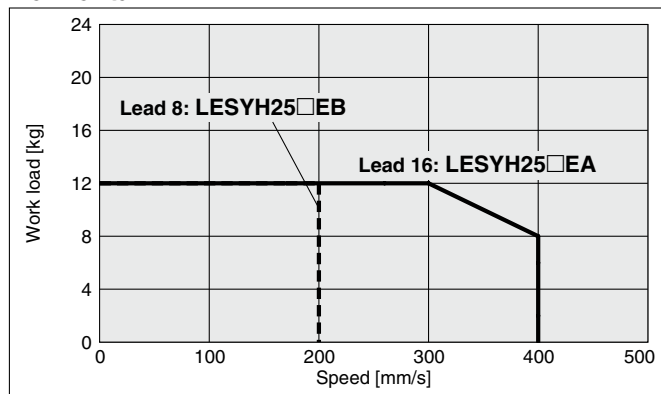

Vertical

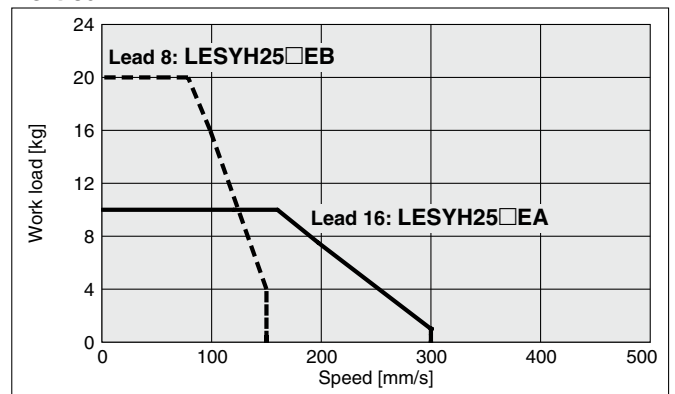

Static Allowable Moment

Model	LESYH8		LESYH16		LESYH25		
	50	75	50	100	50	100	150
Stroke [mm]	50	75	50	100	50	100	150
Pitching [N·m]	11		26	43	77	112	155
Yawing [N·m]	11		26	43	77	112	155
Rolling [N·m]	12		48		146	177	152

LESYH□E Series

Battery-less Absolute (Step Motor 24 VDC)

Pushing Force Set Value–Force Graph

LESYH8□E□

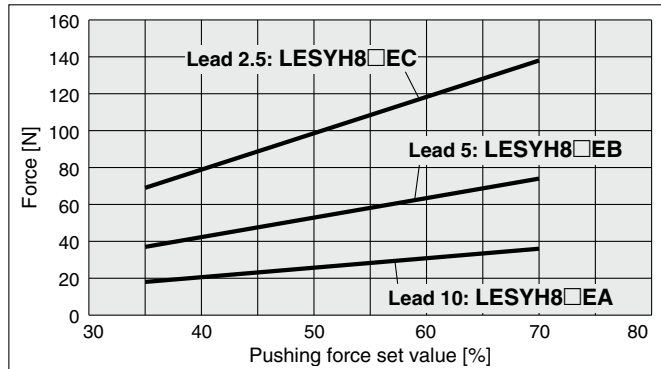

LESYH16□E□

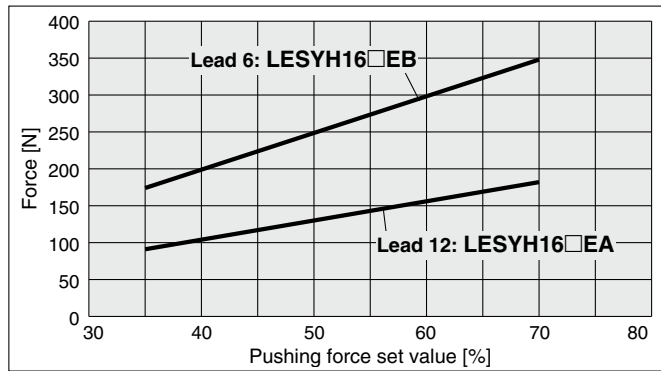

LESYH25□E□

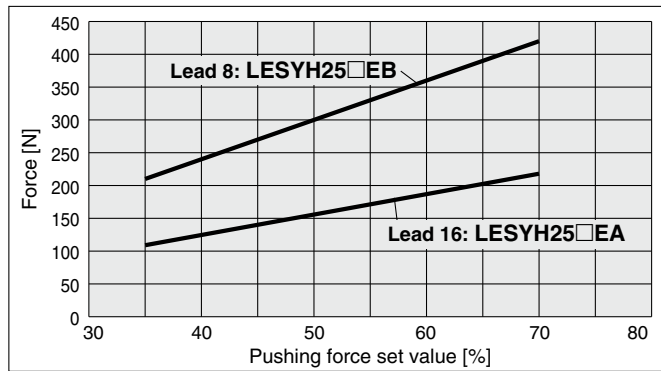

* This graph shows the amount of allowable overhang (guide unit) when the center of gravity of the work-piece overhangs in one direction. When selecting the overhang, refer to the "Calculation of Guide Load Factor" or the Electric Actuator Model Selection Software for confirmation.

Dynamic Allowable Moment

Acceleration/Deceleration — 5000 mm/s²

Orientation		Load overhanging direction m: Work load [kg] Me: Allowable moment [N·m] L: Overhang to the work load center of gravity [mm]	Model		
			LESYH8	LESYH16	LESYH25
Horizontal/Bottom	X				
	Y				
	Z				
Horizontal (Wall)	X				
	Y				
	Z				

* This graph shows the amount of allowable overhang (guide unit) when the center of gravity of the work-piece overhangs in one direction. When selecting the overhang, refer to the "Calculation of Guide Load Factor" or the Electric Actuator Model Selection Software for confirmation.

Dynamic Allowable Moment

Acceleration/Deceleration — 5000 mm/s²

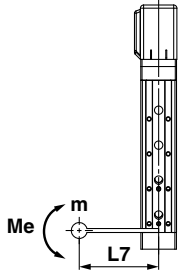
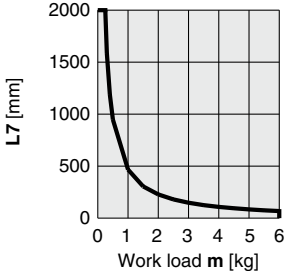
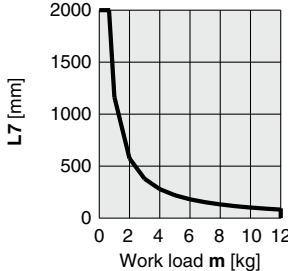
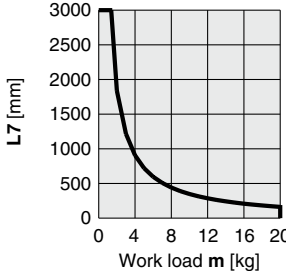
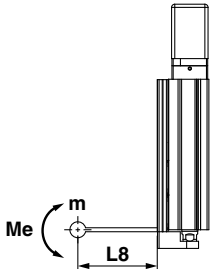
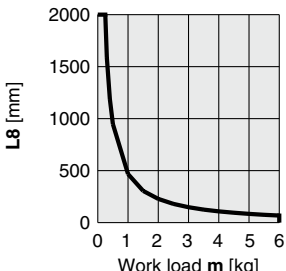
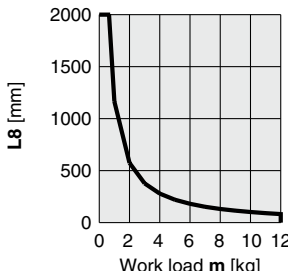
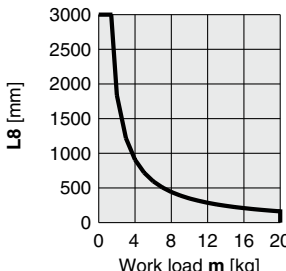
Orientation	Load overhanging direction m: Work load [kg] Me: Allowable moment [N·m] L: Overhang to the work load center of gravity [mm]	Model		
		LESYH8	LESYH16	LESYH25
Vertical	Y 			
	Z 			

Calculation of Guide Load Factor

- Decide operating conditions.

Model: LESYH

Size: 16

Mounting orientation: Horizontal/Bottom/Wall/Vertical

Acceleration [mm/s²]: a

Work load [kg]: m

Work load center position [mm]: Xc/Yc/Zc

- Select the target graph while referencing the model, size, and mounting orientation.

- Based on the acceleration and work load, find the overhang [mm]: Lx/Ly/Lz from the graph.

- Calculate the load factor for each direction.

$$\alpha_x = X_c/L_x, \alpha_y = Y_c/L_y, \alpha_z = Z_c/L_z$$

- Confirm the total of α_x , α_y , and α_z is 1 or less.

$$\alpha_x + \alpha_y + \alpha_z \leq 1$$

When 1 is exceeded, consider a reduction of acceleration and work load, or a change of the work load center position and series.

Mounting orientation

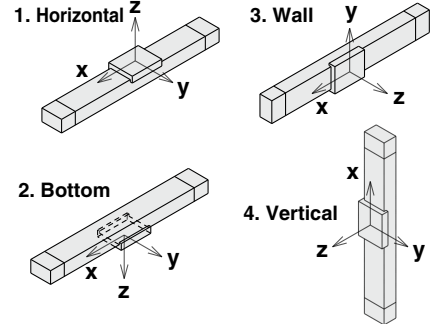

Example

- Operating conditions

Model: LESYH

Size: 16

Mounting orientation: Horizontal

Acceleration [mm/s²]: 5000

Work load [kg]: 4.0

Work load center position [mm]: Xc = 80, Yc = 50, Zc = 60

- Select three graphs from the top of the second row on page 6.

- Lx = 250 mm, Ly = 160 mm, Lz = 700 mm

- The load factor for each direction can be found as follows.

$$\alpha_x = 80/250 = 0.32$$

$$\alpha_y = 50/160 = 0.32$$

$$\alpha_z = 60/700 = 0.09$$

- $\alpha_x + \alpha_y + \alpha_z = 0.73 \leq 1$

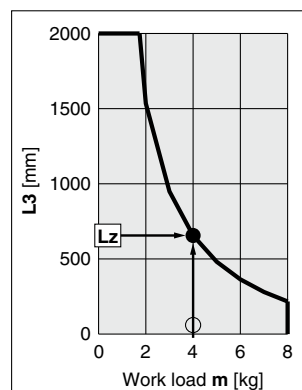
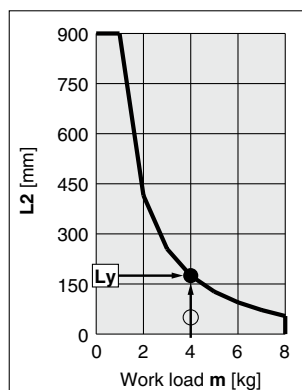
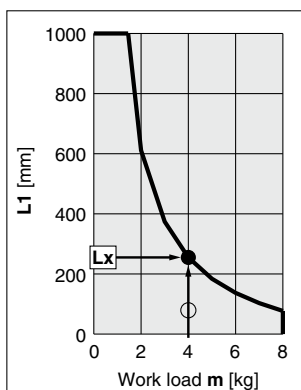

Model Selection



Selection Procedure

Positioning Control Selection Procedure



Selection Example

Step 1 Check the work load-speed. <Speed-Work load graph> (page 10)
 Select a model based on the workpiece mass and speed while referencing the speed-work load graph. Selection example) The **LESYH16□B-50** can be temporarily selected as a possible candidate based on the graph shown on the right side. The regeneration option may be necessary. Refer to page 10 for the "Required Conditions for the Regeneration Option."

Step 2 Check the cycle time.
 Calculate the **cycle time** using the following calculation method.

Cycle time:
 T can be found from the following equation.

$$T = T1 + T2 + T3 + T4 \text{ [s]}$$

- T1: Acceleration time and T3: Deceleration time can be found by the following equation.

$$T1 = V/a1 \text{ [s]} \quad T3 = V/a2 \text{ [s]}$$

- T2: Constant speed time can be found from the following equation.

$$T2 = \frac{L - 0.5 \cdot V \cdot (T1 + T3)}{V} \text{ [s]}$$

- T4: Settling time varies depending on the conditions such as motor types, load, and in position of the step data. Therefore, calculate the settling time while referencing the following value.

$$T4 = 0.15 \text{ [s]}$$

Calculation example)
 T1 to T4 can be calculated as follows.

$$T1 = V/a1 = 200/3000 = 0.07 \text{ [s]}$$

$$T3 = V/a2 = 200/3000 = 0.07 \text{ [s]}$$

$$T2 = \frac{L - 0.5 \cdot V \cdot (T1 + T3)}{V} = \frac{50 - 0.5 \cdot 200 \cdot (0.07 + 0.07)}{200} = 0.18 \text{ [s]}$$

$$T4 = 0.15 \text{ [s]}$$

The cycle time can be found as follows.

$$T = T1 + T2 + T3 + T4 = 0.07 + 0.18 + 0.07 + 0.15 = 0.47 \text{ [s]}$$

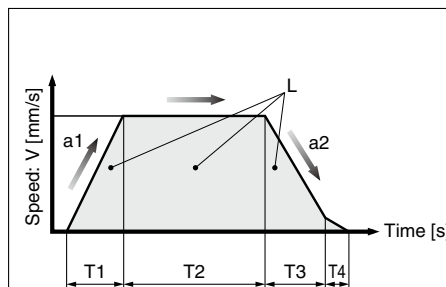

Operating conditions

- Workpiece mass: 1 [kg]
- Workpiece mounting condition:
- Speed: 200 [mm/s]
- Mounting orientation: Vertical
- Stroke: 50 [mm]
- Acceleration/Deceleration: 3000 [mm/s²]
- Cycle time: 0.5 s

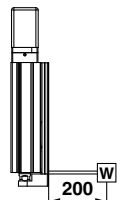

LESYH16□□/AC Servo Motor Vertical

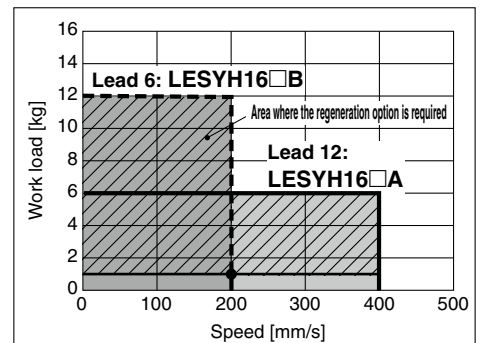

<Speed-Work load graph>

- L : Stroke [mm] (Operating condition)
- V : Speed [mm/s] (Operating condition)
- a1: Acceleration [mm/s²] ... (Operating condition)
- a2: Deceleration [mm/s²] ... (Operating condition)

- T1: Acceleration time [s] ... Time until reaching the set speed
- T2: Constant speed time [s] ... Time while the actuator is operating at a constant speed
- T3: Deceleration time [s] ... Time from the beginning of the constant speed operation to stop
- T4: Settling time [s] ... Time until positioning is completed

Step 3 Check the allowable moment.

<Static allowable moment> (page 4)
 <Dynamic allowable moment> (pages 6, 7)

Confirm the moment that applies to the actuator is within the allowable range for both static and dynamic conditions.

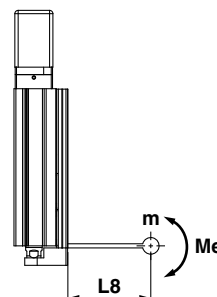

LESYH16/Pitching

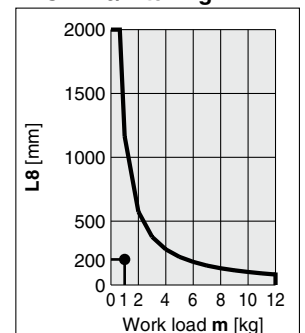

<Dynamic allowable moment>

Based on the above calculation result, the **LESYH16□B-50** should be selected.

LESYH Series

AC Servo Motor

Selection Procedure

Force Control Selection Procedure



Selection Example

Operating conditions

- Pushing force: 210 N
- Workpiece mass: 1 kg
- Speed: 100 mm/s
- Stroke: 100 mm
- Mounting position: Vertical upward
- Pushing time + Operation (A): 5 s
- Full cycle time (B): 10 s

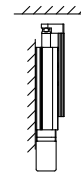

Step 1 Check the required force.

Calculate the approximate required force for a pushing operation. Selection example) • Pushing force: 210 [N]

- Workpiece mass: 1 [kg]

The approximate required force can be found to be $210 + 10 = 220$ [N].

Select a model based on the approximate required force while referencing the specifications (pages 33, 34). Selection example based on the specifications)

- Approximate required force: 220 [N]
- Speed: 100 [mm/s]

The LESYH16□B can be temporarily selected as a possible candidate.

Then, calculate the required force for a pushing operation. If the mounting position is vertical upward, add the actuator table weight.

Selection example based on the table weight)

- LESYH16□B table weight: 0.7 [kg]

The required force can be found to be $220 + 7 = 227$ [N].

Step 2 Check the pushing force.

<Force conversion graph>

Select a model based on the required force while referencing the force conversion graph, and confirm the torque limit/command value.

Selection example) Based on the graph shown on the right side,

- Required force: 227 [N]
- The LESYH16□B can be temporarily selected as a possible candidate.
- The torque limit/command value is 27 [%].

Step 3 Check the duty ratio.

Confirm the allowable duty ratio based on the torque limit/command value while referencing the allowable duty ratio. Selection example based on the allowable duty ratio)

- Torque limit/Command value: 27 [%]

The allowable duty ratio can be found to be 60 [%].

Calculate the duty ratio for the operating conditions, and confirm it does not exceed the allowable duty ratio.

Selection example) • Pushing time + Operation (A): 5 s

- Full cycle time (B): 10 s

The duty ratio can be found to be $5/10 \times 100 = 50$ [%], and this is within the allowable range.

Step 4 Check the allowable moment.

<Static allowable moment> (page 4)

<Dynamic allowable moment> (pages 6, 7)

Confirm the moment that applies to the actuator is within the allowable range for both static and dynamic conditions.

Based on the above calculation result, the LESYH16□B-100 should be selected.

Table Weight

Unit [kg]

Model	Stroke [mm]		
	50	100	150
LESYH16	0.4	0.7	—
LESYH25	0.9	1.3	1.7

* If the mounting position is vertical upward, add the table weight.

LESYH16

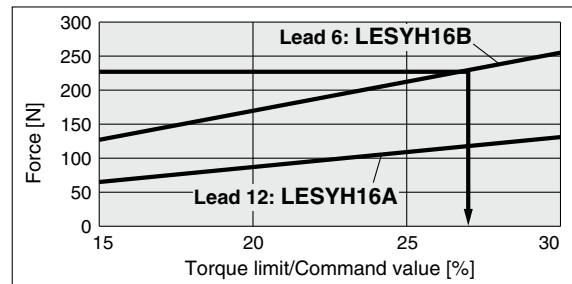

<Force conversion graph>

Allowable Duty Ratio

LESYH16/AC Servo Motor

Torque limit/Command value [%]	Duty ratio [%]	Continuous pushing time [min]
25 or less	100	—
30	60	1.5

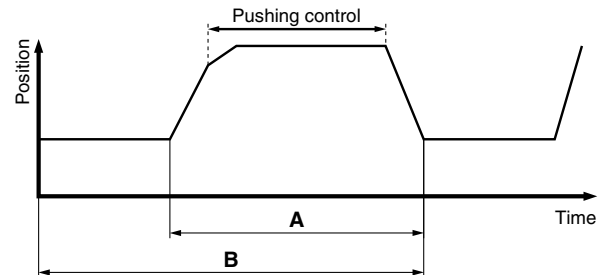

LESYH16/Pitching

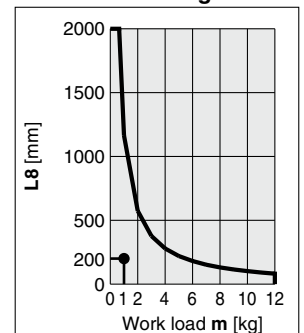

<Dynamic allowable moment>

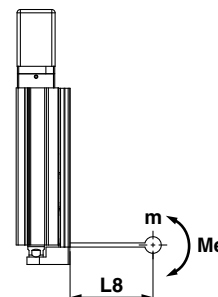

Speed-Work Load Graph/Required Conditions for the Regeneration Option

LESYH16□S2/T6

Horizontal

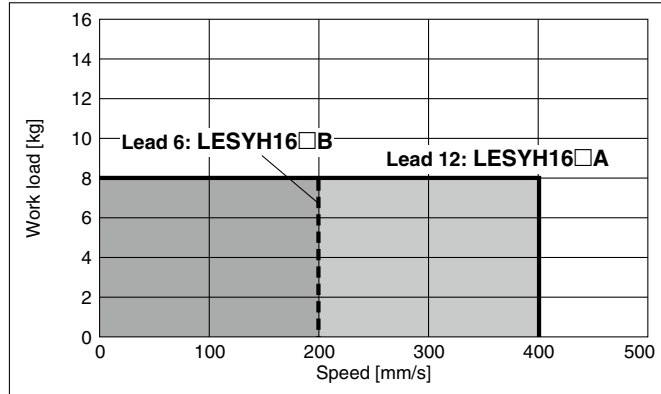

Vertical

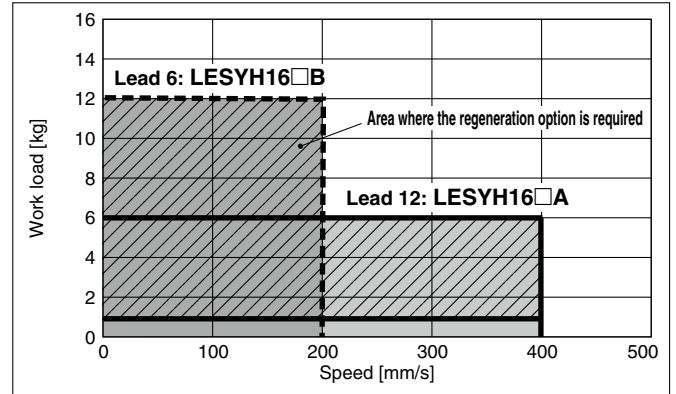

LESYH25□S3/T7

Horizontal

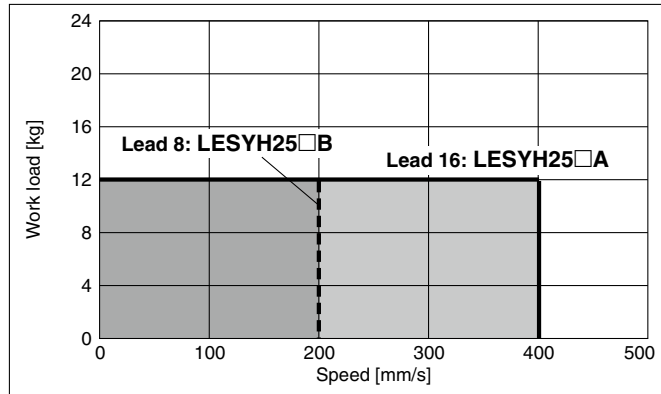

Vertical

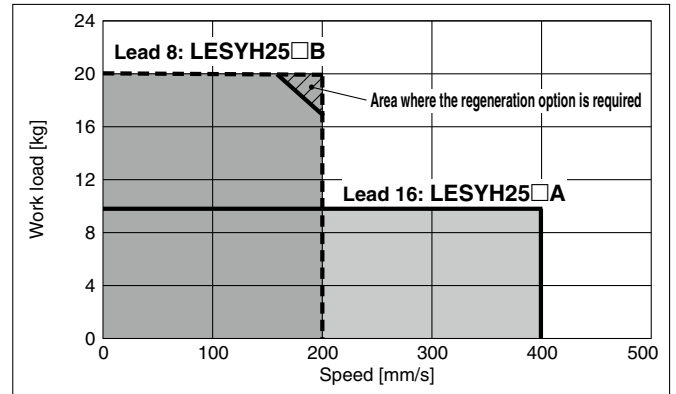

Required conditions for the regeneration option

* The regeneration option is required when using the product above the regeneration line in the graph. (It must be ordered separately.)

Regeneration Option Model

Size	Model
16	LEC-MR-RB-032
25	

LESYH Series

AC Servo Motor

Force Conversion Graph (Guide): LECSA, LECSB, LECS, LECS

LESYH16□S2 (Motor mounting position: Parallel/In-line)

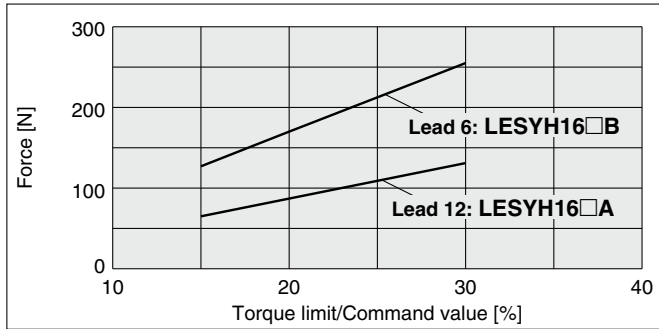

Torque limit/Command value [%]	Duty ratio [%]	Continuous pushing time [min]
25 or less	100	—
30	60	1.5

LESYH25□S3 (Motor mounting position: Parallel)

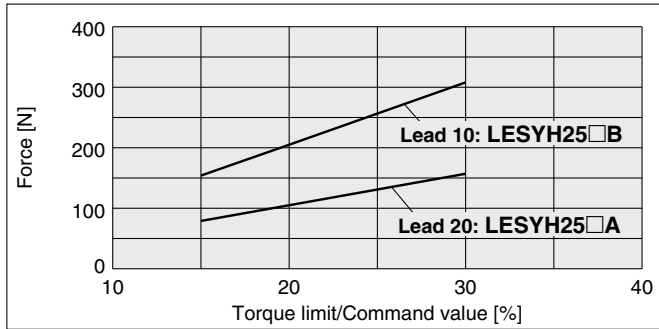

Torque limit/Command value [%]	Duty ratio [%]	Continuous pushing time [min]
25 or less	100	—
30	60	1.5

LESYH25DS3 (Motor mounting position: In-line)

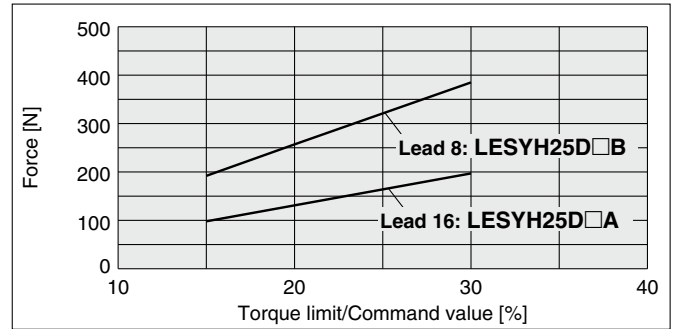

Torque limit/Command value [%]	Duty ratio [%]	Continuous pushing time [min]
25 or less	100	—
30	60	1.5

Force Conversion Graph (Guide): LECSS-T

LESYH16□T6 (Motor mounting position: Parallel/In-line)

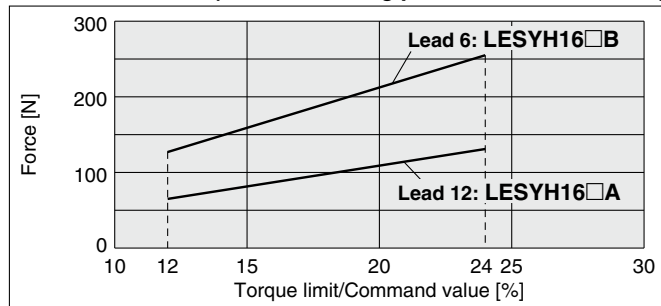

Torque limit/Command value [%]	Duty ratio [%]	Continuous pushing time [min]
20 or less	100	—
24	60	1.5

LESYH25□T7 (Motor mounting position: Parallel)

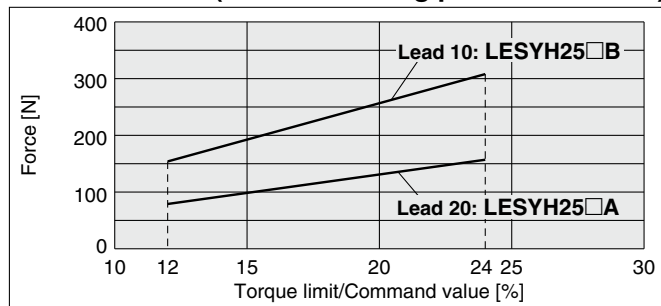

Torque limit/Command value [%]	Duty ratio [%]	Continuous pushing time [min]
20 or less	100	—
24	60	1.5

LESYH25DT7 (Motor mounting position: In-line)

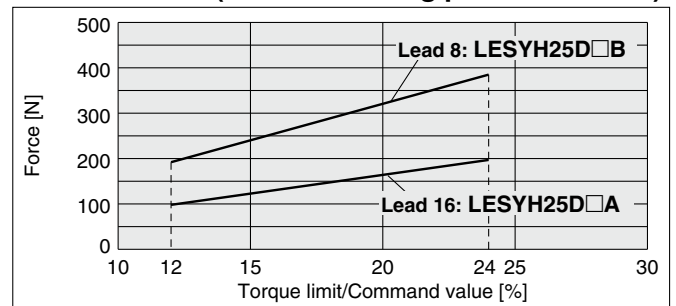

Torque limit/Command value [%]	Duty ratio [%]	Continuous pushing time [min]
20 or less	100	—
24	60	1.5

Model Selection



Selection Procedure

Positioning Control Selection Procedure



Selection Example

Step 1 Check the work load-speed. <Speed-Work load graph> (page 15)
 Select a model based on the workpiece mass and speed while referencing the speed-work load graph. Selection example) The **LESYH16□B-50** can be temporarily selected as a possible candidate based on the graph shown on the right side.
 The regenerative resistor may be necessary. Refer to page 15 for the "Required Conditions for the Regenerative Resistor (Guide)."

Step 2 Check the cycle time.
 Calculate the **cycle time** using the following calculation method.

Cycle time:
 T can be found from the following equation.

$$T = T1 + T2 + T3 + T4 \text{ [s]}$$

- T1: Acceleration time and T3: Deceleration time can be found by the following equation.

$$T1 = V/a1 \text{ [s]} \quad T3 = V/a2 \text{ [s]}$$

- T2: Constant speed time can be found from the following equation.

$$T2 = \frac{L - 0.5 \cdot V \cdot (T1 + T3)}{V} \text{ [s]}$$

- T4: Settling time varies depending on the conditions such as motor types, load, and in position of the step data. Therefore, calculate the settling time while referencing the following value.

$$T4 = 0.15 \text{ [s]}$$

Calculation example)
 T1 to T4 can be calculated as follows.

$$T1 = V/a1 = 200/3000 = 0.07 \text{ [s]}$$

$$T3 = V/a2 = 200/3000 = 0.07 \text{ [s]}$$

$$T2 = \frac{L - 0.5 \cdot V \cdot (T1 + T3)}{V} = \frac{50 - 0.5 \cdot 200 \cdot (0.07 + 0.07)}{200} = 0.18 \text{ [s]}$$

$$T4 = 0.15 \text{ [s]}$$

The cycle time can be found as follows.

$$T = T1 + T2 + T3 + T4 = 0.07 + 0.18 + 0.07 + 0.15 = 0.47 \text{ [s]}$$

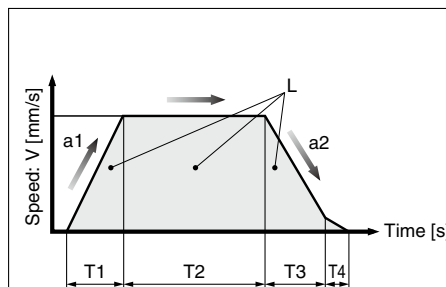

Operating conditions

- Workpiece mass: 1 [kg]
- Speed: 200 [mm/s]
- Mounting orientation: Vertical
- Stroke: 50 [mm]
- Acceleration/Deceleration: 3000 [mm/s²]
- Cycle time: 0.5 s

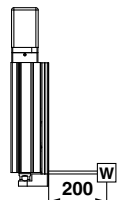

LESYH16□□/AC Servo Motor Vertical

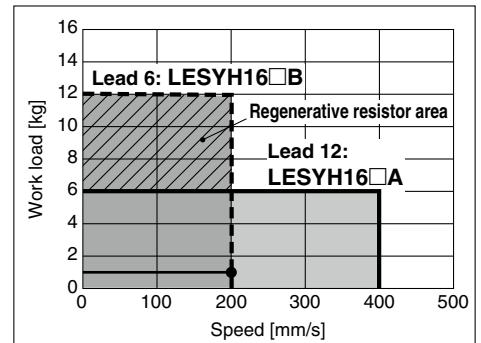

<Speed-Work load graph>

- L : Stroke [mm] (Operating condition)
- V : Speed [mm/s] (Operating condition)
- a1: Acceleration [mm/s²] ... (Operating condition)
- a2: Deceleration [mm/s²] ... (Operating condition)

- T1: Acceleration time [s] ... Time until reaching the set speed
- T2: Constant speed time [s] ... Time while the actuator is operating at a constant speed
- T3: Deceleration time [s] ... Time from the beginning of the constant speed operation to stop
- T4: Settling time [s] ... Time until positioning is completed

Step 3 Check the allowable moment.

<Static allowable moment> (page 4)
 <Dynamic allowable moment> (pages 6, 7)

Confirm the moment that applies to the actuator is within the allowable range for both static and dynamic conditions.

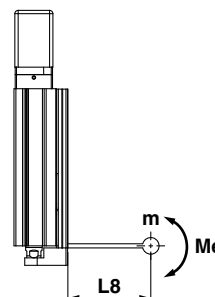

LESYH16/Pitching

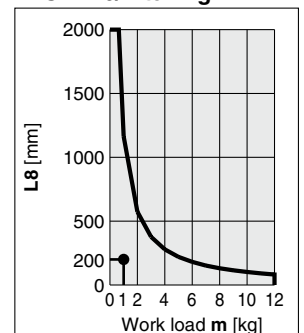

<Dynamic allowable moment>

Based on the above calculation result, the **LESYH16□B-50** should be selected.

Selection Procedure

Force Control Selection Procedure



Selection Example

Operating conditions

- Pushing force: 210 N
- Workpiece mass: 1 kg
- Speed: 100 mm/s
- Stroke: 100 mm
- Mounting position: Vertical upward
- Pushing time + Operation (A): 5 s
- Full cycle time (B): 10 s

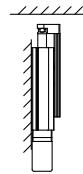

Step 1 Check the required force.

Calculate the approximate required force for a pushing operation.
 Selection example) • Pushing force: 210 [N]
 • Workpiece mass: 1 [kg]

The approximate required force can be found to be $210 + 10 = 220$ [N].

Select a model based on the approximate required force while referencing the specifications (page 39).
 Selection example based on the specifications)

- Approximate required force: 220 [N]
- Speed: 100 [mm/s]

The **LESYH16□B** can be temporarily selected as a possible candidate.

Then, calculate the required force for a pushing operation. If the mounting position is vertical upward, add the actuator table weight.

Selection example based on the table weight)

- **LESYH16□B** table weight: 0.7 [kg]

The required force can be found to be $220 + 7 = 227$ [N].

Step 2 Check the pushing force.

<Force conversion graph>

Select a model based on the required force while referencing the force conversion graph, and confirm the torque limit/command value.
 Selection example) Based on the graph shown on the right side,

- Required force: 227 [N]

The **LESYH16□B** can be temporarily selected as a possible candidate.

The torque limit/command value is 80 [%].

Step 3 Check the duty ratio.

Confirm the allowable duty ratio based on the torque limit/command value while referencing the allowable duty ratio.
 Selection example based on the allowable duty ratio)

- Torque limit/Command value: 81 [%]
- The allowable duty ratio can be found to be 60 [%].

Calculate the duty ratio for the operating conditions, and confirm it does not exceed the allowable duty ratio.

Selection example) • Pushing time + Operation (A): 5 s

- Full cycle time (B): 10 s

The duty ratio can be found to be $5/10 \times 100 = 50$ [%], and this is within the allowable range.

Step 4 Check the allowable moment.

<Static allowable moment> (page 4)

<Dynamic allowable moment> (pages 6, 7)

Confirm the moment that applies to the actuator is within the allowable range for both static and dynamic conditions.

Table Weight

Unit [kg]

Model	Stroke [mm]		
	50	100	150
LESYH16	0.4	0.7	—
LESYH25	0.9	1.3	1.7

* If the mounting position is vertical upward, add the table weight.

LESYH16

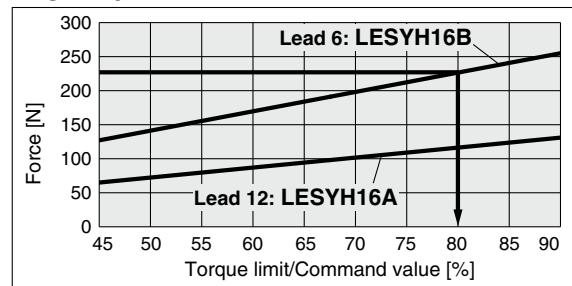

<Force conversion graph>

Allowable Duty Ratio

LESYH16/AC Servo Motor

Pushing force set value [%]	Duty ratio [%]	Continuous pushing time [min]
75 or less	100	—
90	60	1.5

* [Pushing force set value] is one of the data input to the driver.

* [Continuous pushing time] is the time that the actuator can continuously keep pushing.

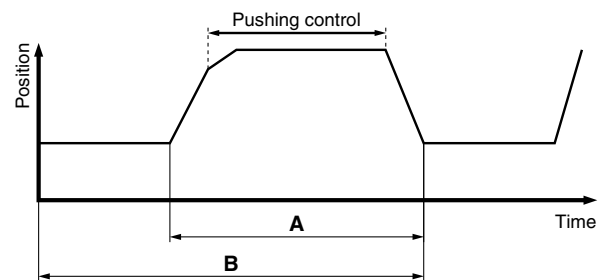

LESYH16/Pitching

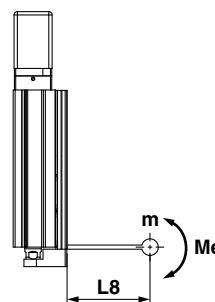
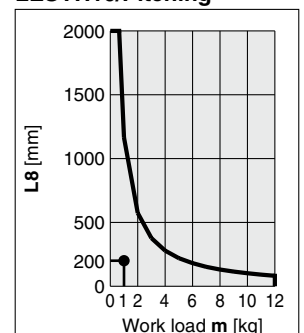

<Dynamic allowable moment>

Based on the above calculation result, the **LESYH16□B-100** should be selected.

LESYH Series

AC Servo Motor

Speed–Work Load Graph/Required Conditions for the Regenerative Resistor (Guide)

LESYH16□V6

Horizontal

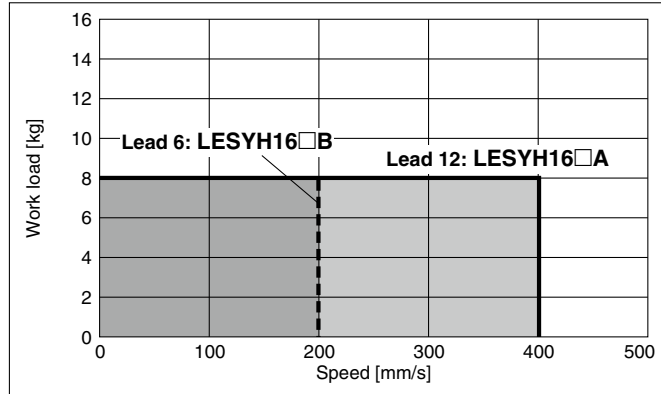

Vertical

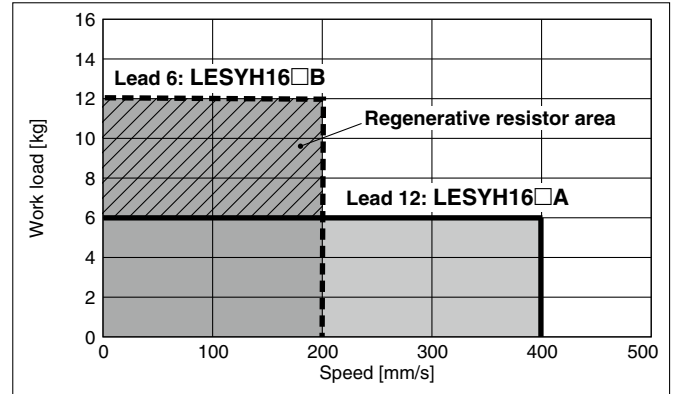

LESYH25□V7

Horizontal

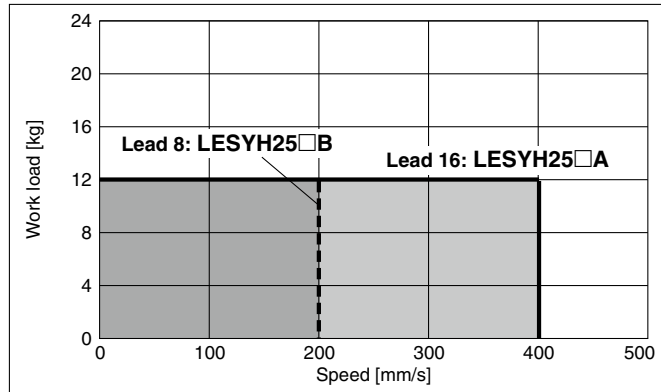

Vertical

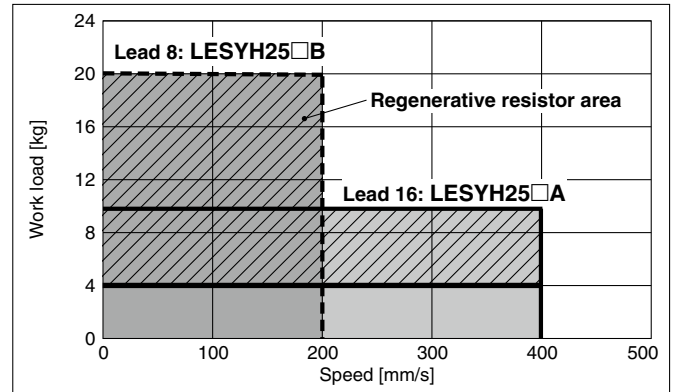

Regenerative resistor area

* When using the actuator in the regenerative resistor area, download the "AC servo drive capacity selection program/SigmaJunmaSize+" from the SMC website. Then, calculate the necessary regenerative resistor capacity to prepare an appropriate external regenerative resistor.

* The regenerative resistor should be provided by the customer.

Applicable Motors/Drivers

Model	Applicable model	
	Motor	Servopack (SMC driver)
LESYH25□	SGMJV-01A3A	SGDV-R90A11□(LECYM2-V5) SGDV-R90A21□(LECYU2-V5)
LESYH32□	SGMJV-02A3A	SGDV-1R6A11□(LECYM2-V7) SGDV-1R6A21□(LECYU2-V7)

Force Conversion Graph (Guide)

LESYH16□V6 (Motor mounting position: Parallel/In-line)

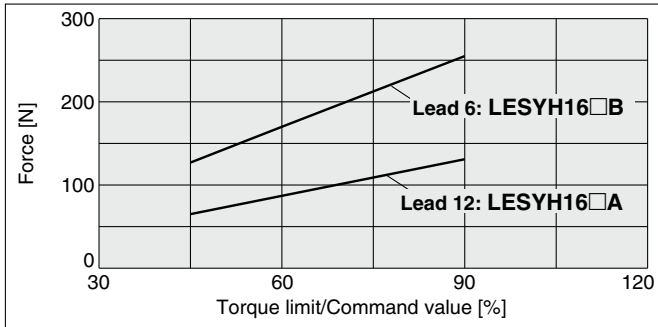

Torque limit/Command value [%]	Duty ratio [%]	Continuous pushing time [min]
75 or less	100	—
90	60	1.5

LESYH25□V7 (Motor mounting position: Parallel)

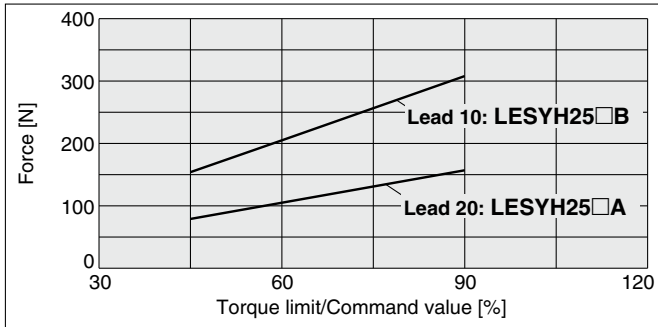

Torque limit/Command value [%]	Duty ratio [%]	Continuous pushing time [min]
75 or less	100	—
90	60	1.5

LESYH25DV7 (Motor mounting position: In-line)

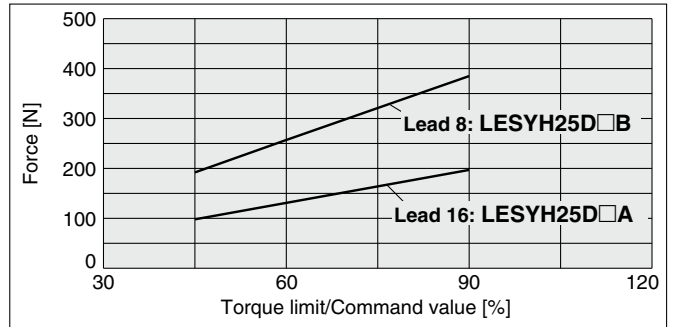

Torque limit/Command value [%]	Duty ratio [%]	Continuous pushing time [min]
75 or less	100	—
90	60	1.5

LESYH Series

Battery-less Absolute (Step Motor 24 VDC)

AC Servo Motor

Table Accuracy

* These values are initial guideline values.

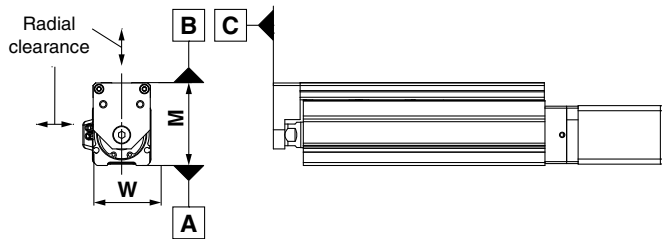

Model	LESYH8	LESYH16	LESYH25
B side parallelism to A side [mm]	Refer to Table 1.		
B side traveling parallelism to A side [mm]	Refer to Graph 1.		
C side perpendicularity to A side [mm]	0.05	0.05	0.05
M dimension tolerance [mm]	±0.3		
W dimension tolerance [mm]	±0.2		
Radial clearance [μm]	-4 to 0	-10 to 0	-14 to 0

Table 1 B side parallelism to A side

Model	Stroke [mm]			
	50	75	100	150
LESYH8	0.055	0.065	—	—
LESYH16	0.05	—	0.08	—
LESYH25	0.06	—	0.08	0.125

Graph 1 B side traveling parallelism to A side

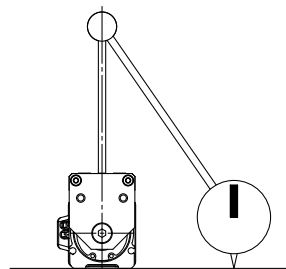
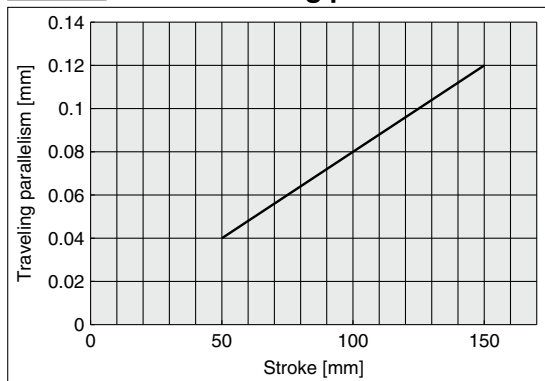

Traveling parallelism:
The amount of deflection on a dial gauge when the table travels a full stroke with the body secured on a reference base surface

Table Deflection (Reference Value)

* These values are initial guideline values.

Table displacement due to pitch moment load
Table displacement when loads are applied to the section marked with the arrow with the slide table stuck out.



LESYH8

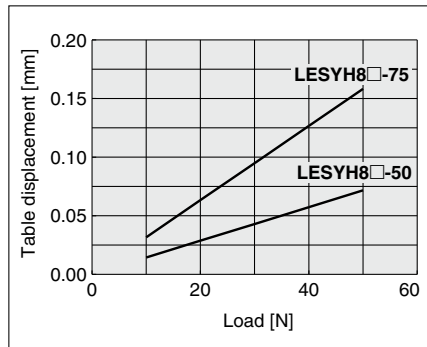
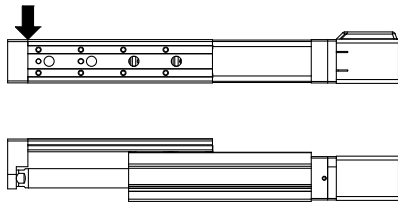

Table displacement due to yaw moment load
Table displacement when loads are applied to the section marked with the arrow with the slide table stuck out.



LESYH8

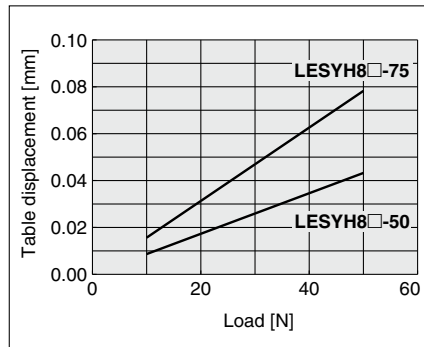
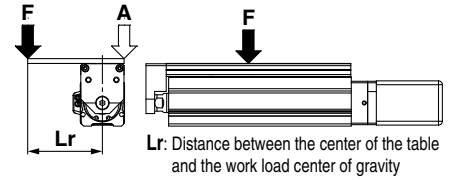
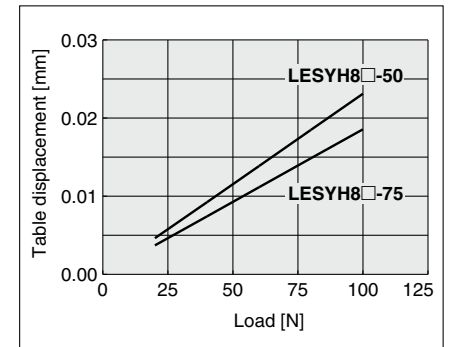

Table displacement due to roll moment load
Table displacement of section A when loads are applied to the section F with the slide table retracted.



LESYH8

Lr = 70 mm



LESYH16

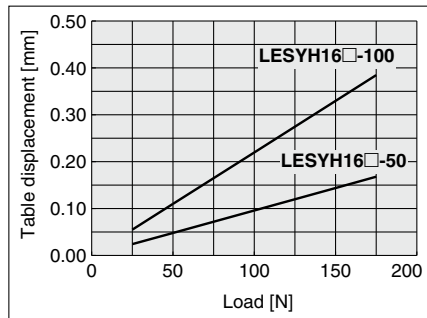

LESYH16

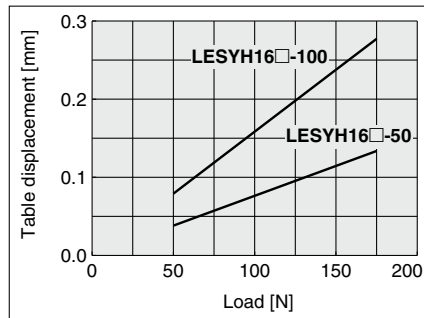

LESYH16

Lr = 120 mm

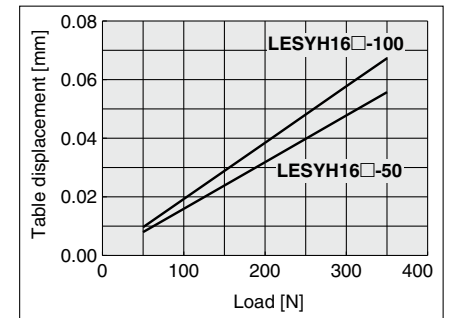

LESYH25

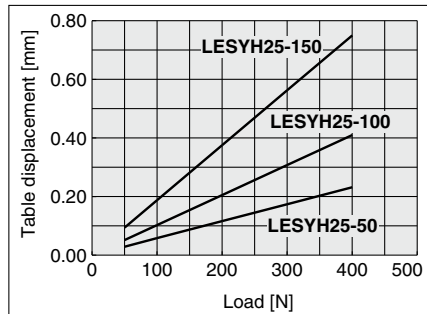

LESYH25

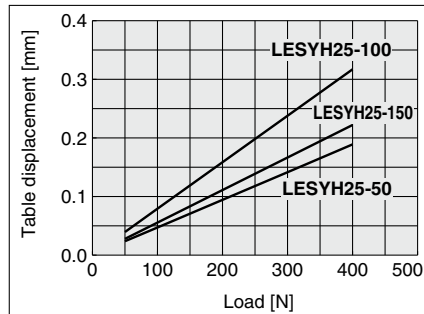

LESYH25

Lr = 200 mm

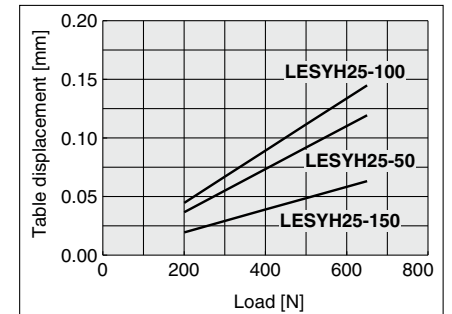

Model Selection 1



Selection Procedure

Positioning Control Selection Procedure



Selection Example

The model selection method shown below corresponds to SMC's standard motor. For use in combination with a motor from a different manufacturer, check the available product information of the motor to be used.

Step 1 Check the work load-speed. <Speed-Work load graph> (page 21)
Select a model based on the workpiece mass and speed while referencing the speed-work load graph. Selection example) The LESYH16□B-50 can be temporarily selected as a possible candidate based on the graph shown on the right side.

* Refer to the selection method of motor manufacturers for regeneration resistance.

Step 2 Check the cycle time.

Calculate the cycle time using the following calculation method.

Cycle time:

T can be found from the following equation.

$$T = T1 + T2 + T3 + T4 \text{ [s]}$$

- T1: Acceleration time and T3: Deceleration time can be found by the following equation.

$$T1 = V/a1 \text{ [s]}$$

$$T3 = V/a2 \text{ [s]}$$

- T2: Constant speed time can be found from the following equation.

$$T2 = \frac{L - 0.5 \cdot V \cdot (T1 + T3)}{V} \text{ [s]}$$

- T4: Settling time varies depending on the conditions such as motor types, load, and in position of the step data. Therefore, calculate the settling time while referencing the following value.

$$T4 = 0.15 \text{ [s]}$$

Calculation example)

T1 to T4 can be calculated as follows.

$$T1 = V/a1 = 200/3000 = 0.07 \text{ [s]}$$

$$T3 = V/a2 = 200/3000 = 0.07 \text{ [s]}$$

$$T2 = \frac{L - 0.5 \cdot V \cdot (T1 + T3)}{V} = \frac{50 - 0.5 \cdot 200 \cdot (0.07 + 0.07)}{200} = 0.18 \text{ [s]}$$

$$T4 = 0.15 \text{ [s]}$$

The cycle time can be found as follows.

$$T = T1 + T2 + T3 + T4 = 0.07 + 0.18 + 0.07 + 0.15 = 0.47 \text{ [s]}$$

Operating conditions

- Workpiece mass: 1 [kg]
- Workpiece mounting condition:
- Speed: 200 [mm/s]
- Mounting orientation: Vertical
- Stroke: 50 [mm]
- Acceleration/Deceleration: 3000 [mm/s²]
- Cycle time: 0.5 s

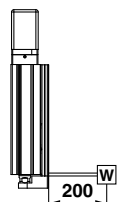

LESYH16□□/AC Servo Motor Vertical

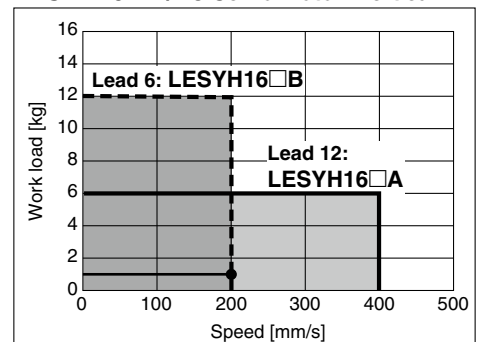

<Speed-Work load graph>

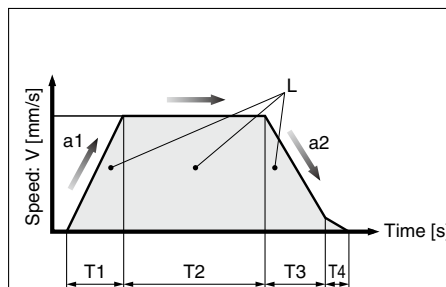

- L : Stroke [mm] (Operating condition)
- V : Speed [mm/s] (Operating condition)
- a1: Acceleration [mm/s²] ... (Operating condition)
- a2: Deceleration [mm/s²] ... (Operating condition)

- T1: Acceleration time [s] ... Time until reaching the set speed
- T2: Constant speed time [s] ... Time while the actuator is operating at a constant speed
- T3: Deceleration time [s] ... Time from the beginning of the constant speed operation to stop
- T4: Settling time [s] ... Time until positioning is completed

Step 3 Check the allowable moment.

<Static allowable moment> (page 21)

<Dynamic allowable moment> (pages 22, 23)

Confirm the moment that applies to the actuator is within the allowable range for both static and dynamic conditions.

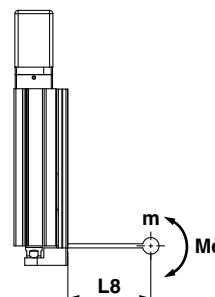

LESYH16/Pitching

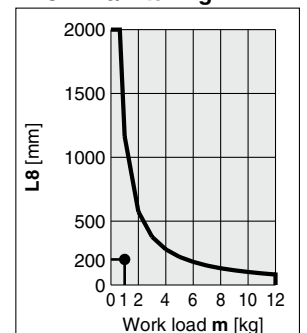

<Dynamic allowable moment>

Based on the above calculation result, the LESYH16□□B-50 should be selected.

Selection Procedure

Force Control Selection Procedure

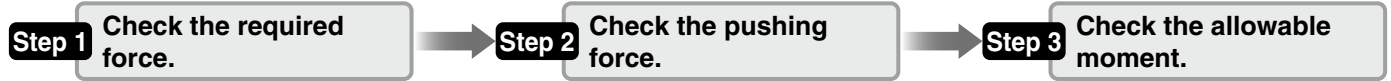

Selection Example

The model selection method shown below corresponds to SMC's standard motor. For use in combination with a motor from a different manufacturer, check the available product information of the motor to be used.

Operating conditions

- Pushing force: 210 N
- Workpiece mass: 1 kg
- Speed: 100 mm/s
- Stroke: 100 mm
- Mounting position: Vertical upward
- Pushing time + Operation (A): 5 s
- Full cycle time (B): 10 s

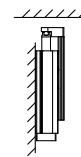

Step 1 Check the required force.

Calculate the approximate required force for a pushing operation. Selection example) ● Pushing force: 210 [N]

- Workpiece mass: 1 [kg]

The approximate required force can be found to be $210 + 10 = 220$ [N].

Select a model based on the approximate required force while referencing the specifications (page 43).

Selection example based on the specifications)

- Approximate required force: 220 [N]
- Speed: 100 [mm/s]

The LESYH16□B can be temporarily selected as a possible candidate.

Then, calculate the required force for a pushing operation. If the mounting position is vertical upward, add the actuator table weight.

Selection example based on the table weight)

- LESYH16□B table weight: 0.7 [kg]

The required force can be found to be $220 + 7 = 227$ [N].

Step 2 Check the pushing force. <Force conversion graph>

Select a model based on the ratio to rated torque and force while referencing the force conversion graph.

Selection example)

Based on the graph shown on the right side,

- Ratio to rated torque: 80 [%]
- Force: 227 [N]

The LESYH16B can be temporarily selected as a possible candidate.

Step 3 Check the allowable moment.

<Static allowable moment> (page 21)

<Dynamic allowable moment> (pages 22, 23)

Confirm the moment that applies to the actuator is within the allowable range for both static and dynamic conditions.

Table Weight

Unit [kg]

Model	Stroke [mm]		
	50	100	150
LESYH16	0.4	0.7	—
LESYH25	0.9	1.3	1.7

* If the mounting position is vertical upward, add the table weight.

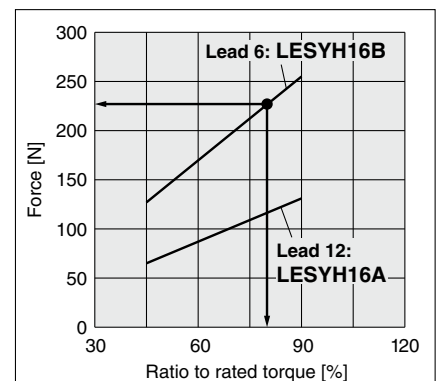

<Force conversion graph>

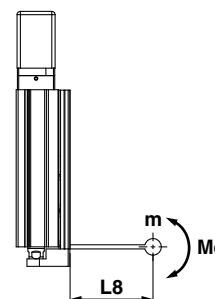

LESYH16/Pitching

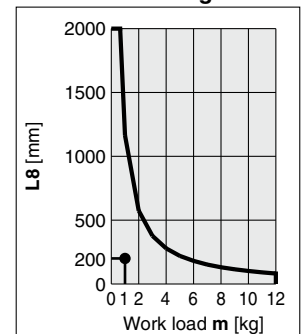

<Dynamic allowable moment>

Based on the above calculation result, the LESYH16□N□B-100 should be selected.

LESYH Series

Motorless Type

Speed-Work Load Graph (Guide)

LESYH16□

Horizontal

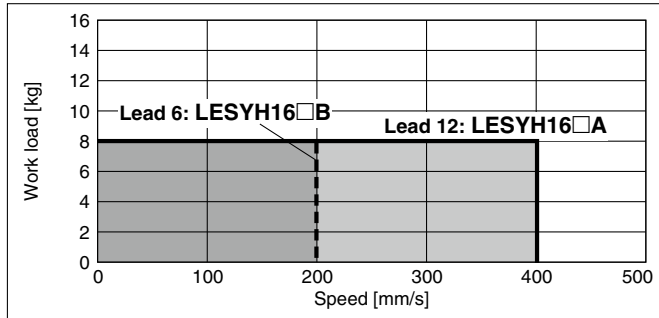

Vertical

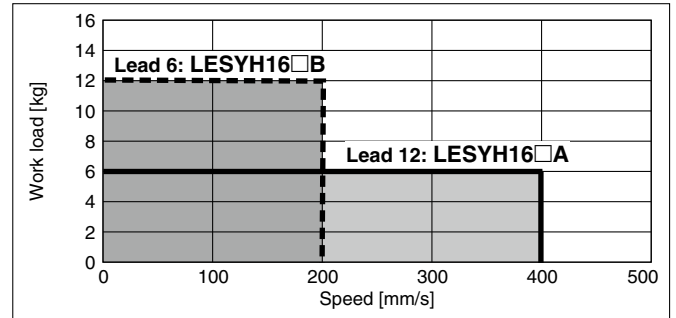

LESYH25□

Horizontal

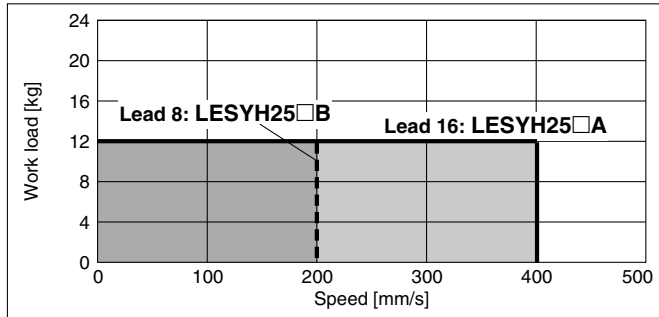

Vertical

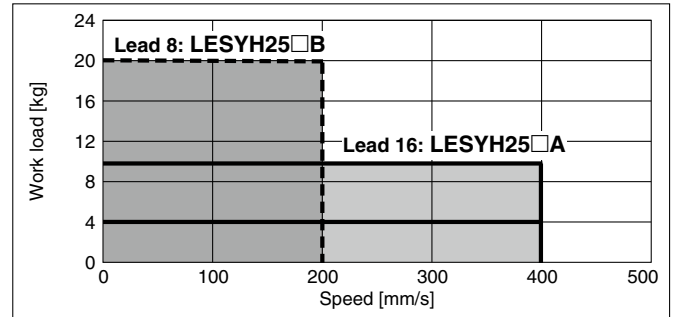

Force Conversion Graph (Guide)

* These graphs show an example of when the standard motor is mounted. Calculate the force based on used motor and driver.

LESYH16□ (Motor mounting position: Parallel/In-line)

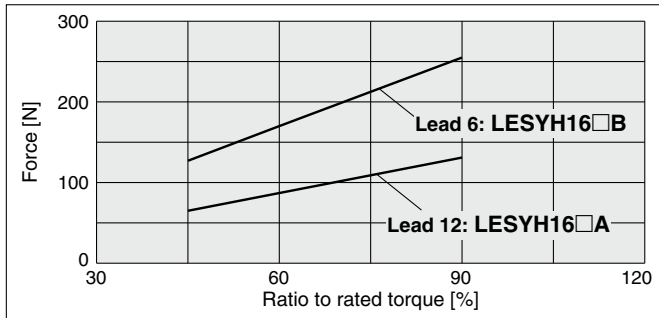

LESYH25□ (Motor mounting position: Parallel)

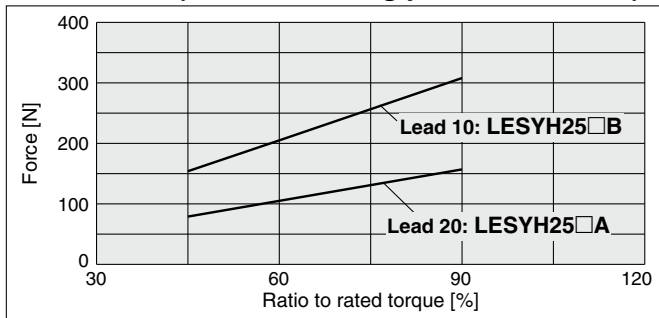

LESYH25D□ (Motor mounting position: In-line)

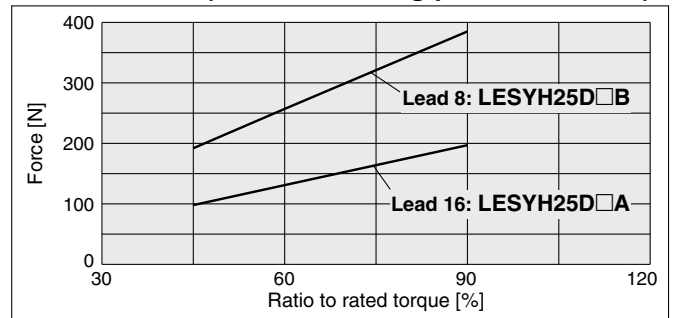

* When using the force control or speed control, set the max. value to be no more than 90% of the rated torque.

Static Allowable Moment

Model	LESYH16		LESYH25		
	50	100	50	100	150
Pitching [N·m]	26	43	77	112	155
Yawing [N·m]					
Rolling [N·m]	48		146	177	152

* This graph shows the amount of allowable overhang (guide unit) when the center of gravity of the work-piece overhangs in one direction. When selecting the overhang, refer to the "Calculation of Guide Load Factor" or the Electric Actuator Model Selection Software for confirmation.

Dynamic Allowable Moment

Acceleration/Deceleration — 5000 mm/s²

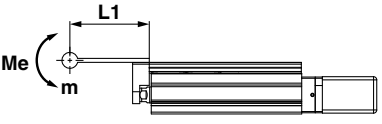
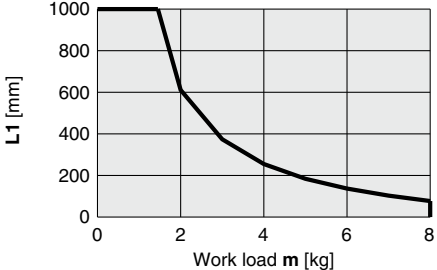
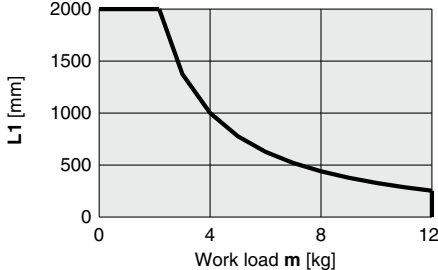
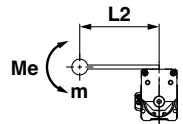
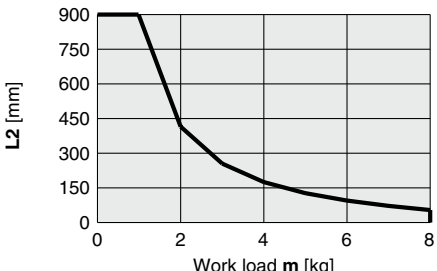
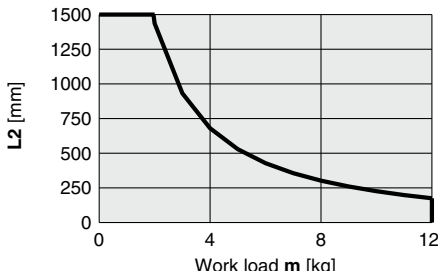
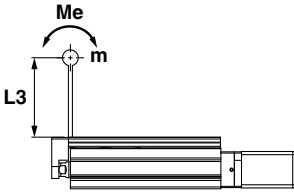
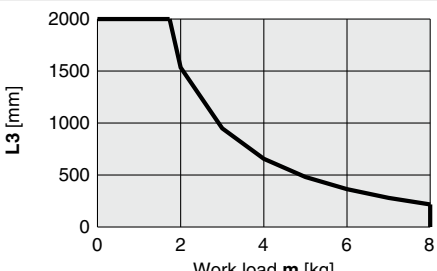
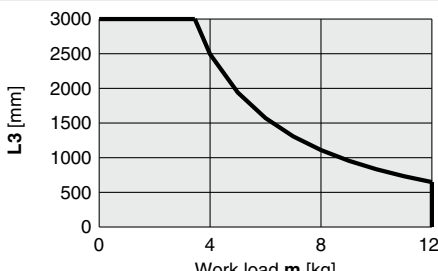
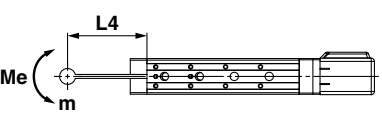
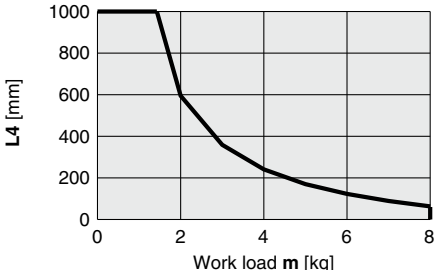
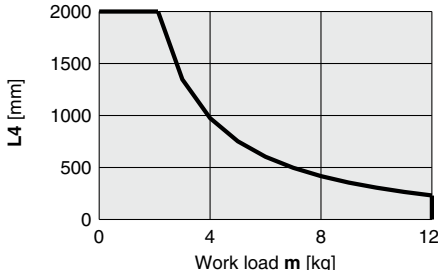
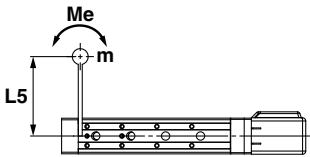
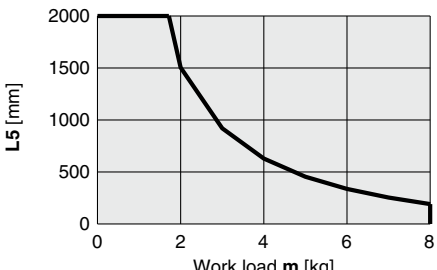
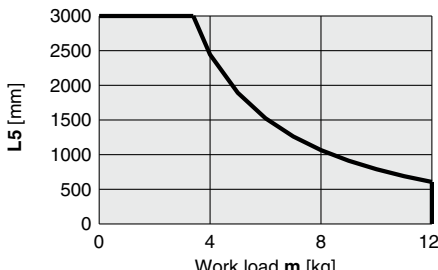
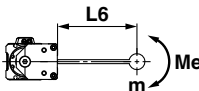
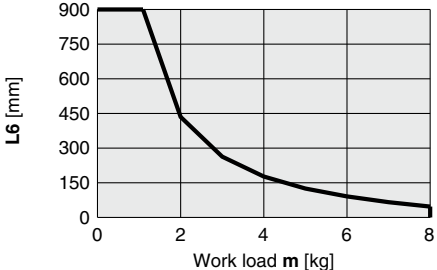
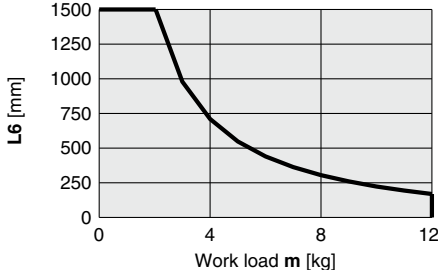
Orientation		Load overhanging direction	Model	
		m : Work load [kg] Me : Allowable moment [N·m] L : Overhang to the work load center of gravity [mm]	LESYH16	LESYH25
Horizontal/Bottom	X			
	Y			
	Z			
Horizontal (Wall)	X			
	Y			
	Z			

LESYH Series

Motorless Type

* This graph shows the amount of allowable overhang (guide unit) when the center of gravity of the work-piece overhangs in one direction. When selecting the overhang, refer to the "Calculation of Guide Load Factor" or the Electric Actuator Model Selection Software for confirmation

Dynamic Allowable Moment

Acceleration/Deceleration — 5000 mm/s²

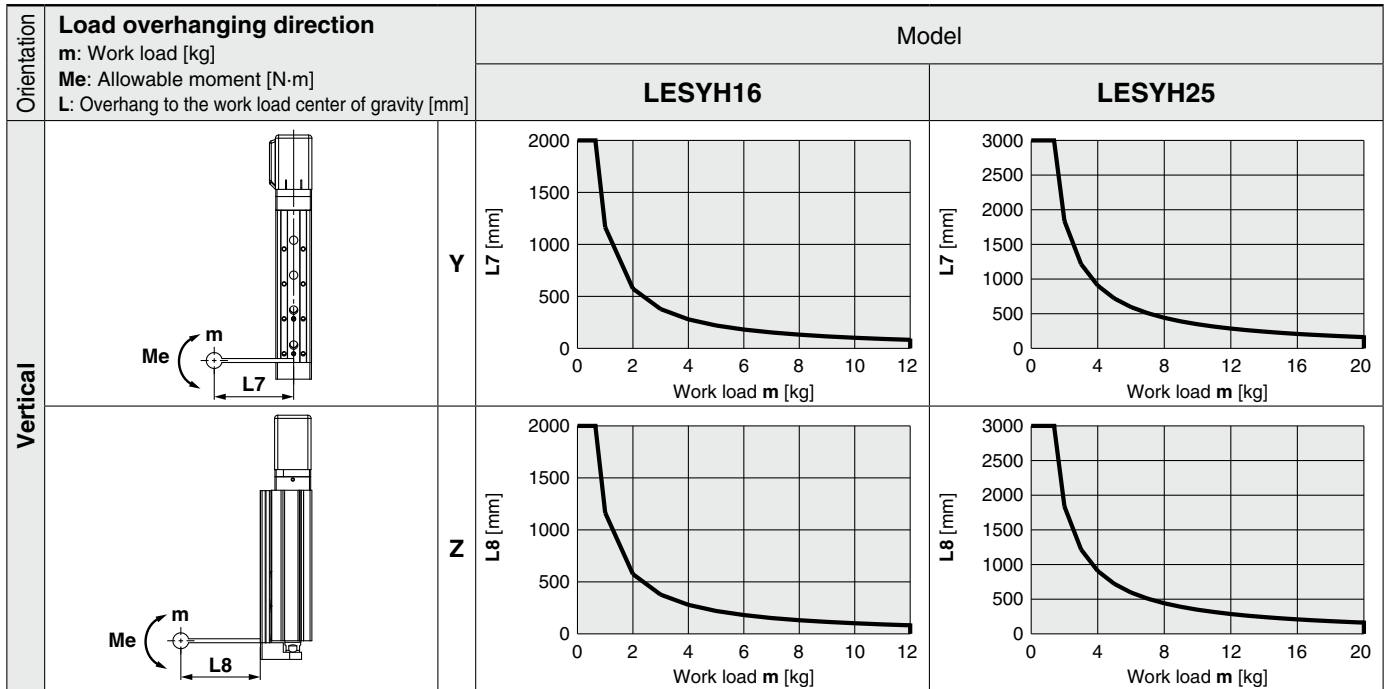

Calculation of Guide Load Factor

- Decide operating conditions.

Model: LESYH

Size: 16

Mounting orientation: Horizontal/Bottom/Wall/Vertical

Acceleration [mm/s²]: a

Work load [kg]: m

Work load center position [mm]: Xc/Yc/Zc

- Select the target graph while referencing the model, size, and mounting orientation.

- Based on the acceleration and work load, find the overhang [mm]: Lx/Ly/Lz from the graph.

- Calculate the load factor for each direction.

$$\alpha_x = X_c/L_x, \alpha_y = Y_c/L_y, \alpha_z = Z_c/L_z$$

- Confirm the total of α_x , α_y , and α_z is 1 or less.

$$\alpha_x + \alpha_y + \alpha_z \leq 1$$

When 1 is exceeded, consider a reduction of acceleration and work load, or a change of the work load center position and series.

Mounting orientation

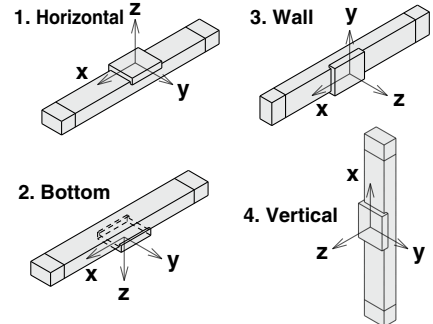

Example

- Operating conditions

Model: LESYH

Size: 16

Mounting orientation: Horizontal

Acceleration [mm/s²]: 5000

Work load [kg]: 4.0

Work load center position [mm]: Xc = 80, Yc = 50, Zc = 60

- Select three graphs from the top of the first row on page 22.

- Lx = 250 mm, Ly = 160 mm, Lz = 700 mm

- The load factor for each direction can be found as follows.

$$\alpha_x = 80/250 = 0.32$$

$$\alpha_y = 50/160 = 0.32$$

$$\alpha_z = 60/700 = 0.09$$

- $\alpha_x + \alpha_y + \alpha_z = 0.73 \leq 1$

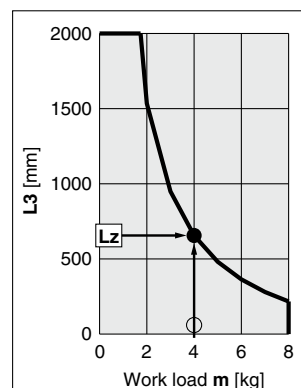
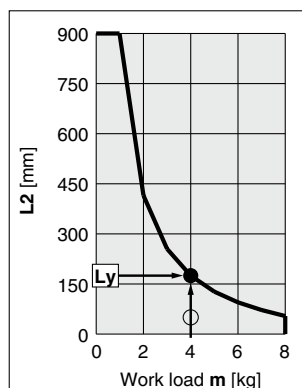
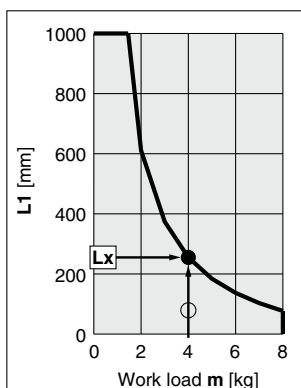
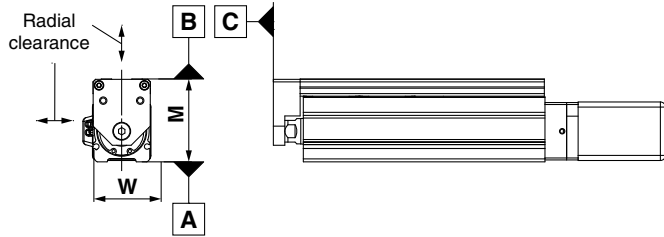

Table Accuracy

* These values are initial guideline values.



Model	LESYH16	LESYH25
B side parallelism to A side [mm]	Refer to Table 1.	
B side traveling parallelism to A side [mm]	Refer to Graph 1.	
C side perpendicularity to A side [mm]	0.05	
M dimension tolerance [mm]	±0.3	
W dimension tolerance [mm]	±0.2	
Radial clearance [μm]	-10 to 0	-14 to 0

Table 1 B side parallelism to A side

Model	Stroke [mm]		
	50	100	150
LESYH16	0.05	0.08	—
LESYH25	0.06	0.08	0.125

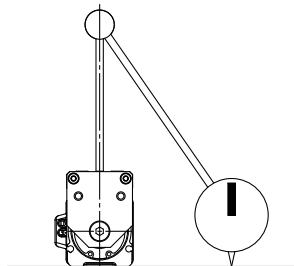

Traveling parallelism:
The amount of deflection on a dial gauge when the table travels a full stroke with the body secured on a reference base surface

Graph 1 B side traveling parallelism to A side

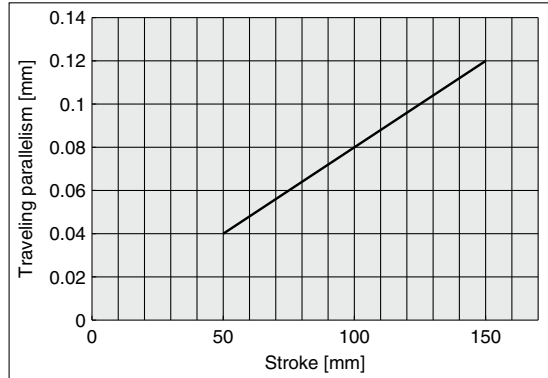
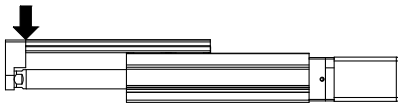

Table Deflection (Reference Value)

* These values are initial guideline values.

Table displacement due to pitch moment load
Table displacement when loads are applied to the section marked with the arrow with the slide table stuck out.



LESYH16

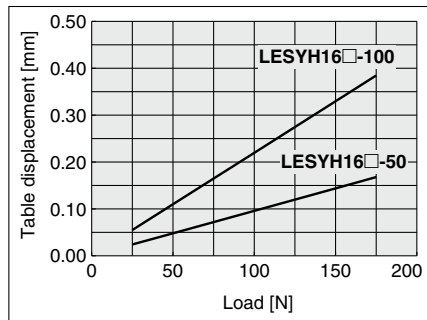
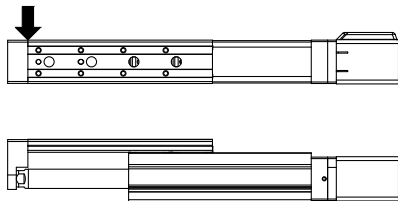

Table displacement due to yaw moment load
Table displacement when loads are applied to the section marked with the arrow with the slide table stuck out.



LESYH16

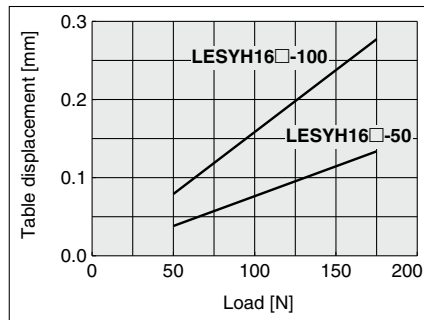
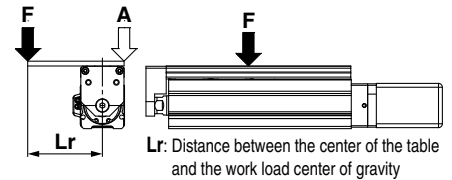
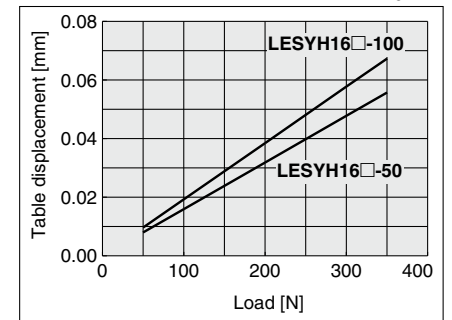

Table displacement due to roll moment load
Table displacement of section A when loads are applied to the section F with the slide table retracted.



LESYH16

Lr = 120 mm



LESYH25

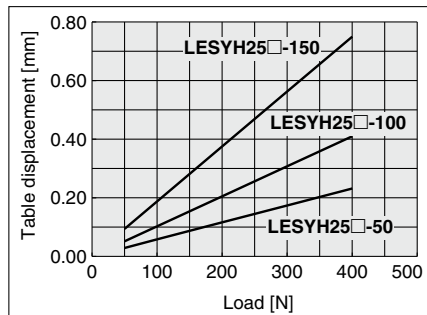

LESYH25

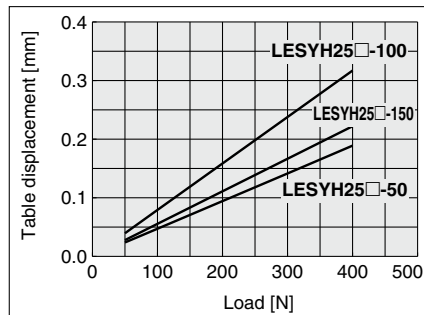

LESYH25

Lr = 200 mm

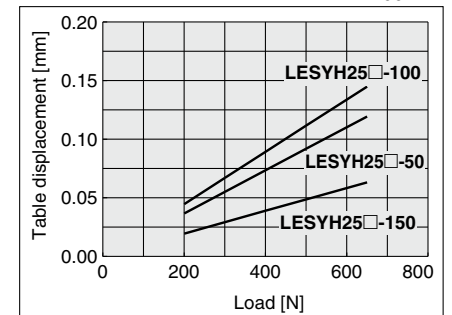

Battery-less Absolute Encoder: Slide Table/High Precision Type *LESYH Series*



How to Order

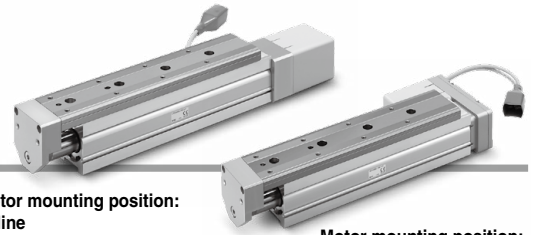

Motor mounting position:
In-line

Motor mounting position:
Right side parallel

LESYH **16** **D1** **E** **A** - **50** **C** - **R1** **CD17T**

①
②
③
④
⑤
⑥
⑦
⑧

For details on controllers,
refer to the next page.

① Size

8
16
25

② Motor mounting position/Motor cover direction

Symbol	Motor mounting position	Motor cover direction
D1	In-line	Left side
D2		Right side
D3		Top side
D4		Bottom side
R	Right side parallel	—
L	Left side parallel	—

③ Motor type

Symbol	Motor type	Compatible controllers	
E	Battery-less absolute (Step motor 24 VDC)	JXCE1 JXC91 JXCP1 JXCD1	JXCL1 JXCM1 JXC51 JXC61

④ Lead [mm]

	Size		
	8	16	25
A	10	12	16
B	5	6	8
C	2.5	—	—

⑤ Stroke [mm]

	Size		
	8	16	25
50	●	●	●
75	●	—	—
100	—	●	●
150	—	—	●

⑥ Motor option

C	Without lock
W	With lock

⑦ Actuator cable type/length

Robotic cable				[m]
Nil	Without cable	R8		8*1
R1	1.5	RA		10*1
R3	3	RB		15*1
R5	5	RC		20*1

For details on auto switches,
refer to the **Web Catalog**.

Battery-less Absolute Encoder: Slide Table/High Precision Type **LESYH Series**

Battery-less Absolute (Step Motor 24 VDC)

8 Controller

Nil	Without controller
C□1□□	With controller

C D 1 7 T

Interface (Communication protocol/Input/Output)

E	EtherCAT®
9	EtherNet/IP™
P	PROFINET
D	DeviceNet™
L	IO-Link
M	CC-Link Ver. 1.10
5	Parallel input (NPN)
6	Parallel input (PNP)

Mounting

7	Screw mounting
8*2	DIN rail

• For single axis

Communication plug connector, I/O cable*3

Symbol	Type	Applicable interface
Nil	Without accessory	—
S	Straight type communication plug connector	DeviceNet™
T	T-branch type communication plug connector	CC-Link Ver. 1.10
1	I/O cable (1.5 m)	Parallel input (NPN) Parallel input (PNP)
3	I/O cable (3 m)	
5	I/O cable (5 m)	

*1 Produced upon receipt of order

*2 The DIN rail is not included. It must be ordered separately.

*3 Select "Nil" for anything other than DeviceNet™, CC-Link, or parallel input.

Select "Nil," "S," or "T" for DeviceNet™ or CC-Link.

Select "Nil," "1," "3," or "5" for parallel input.

⚠ Caution

[CE-compliant products]

EMC compliance was tested by combining the electric actuator LES series and the controller JXC series.

The EMC depends on the configuration of the customer's control panel and the relationship with other electrical equipment and wiring. Therefore, compliance with the EMC directive cannot be certified for SMC components incorporated into the customer's equipment under actual operating conditions. As a result, it is necessary for the customer to verify compliance with the EMC directive for the machinery and equipment as a whole.

[Precautions relating to differences in controller versions]

When the JXC series is to be used in combination with the battery-less absolute encoder, use a controller that is version V3.4 or S3.4 or higher. For details, refer to the [Web Catalog](#).

[UL-compliant products]

The JXC series controllers used in combination with electric actuators are UL certified.

The actuator and controller are sold as a package.

Confirm that the combination of the controller and actuator is correct.

<Check the following before use.>

*1 Check the actuator label for the model number. This number should match that of the controller.

LESYH16REA-50C

*1



* Refer to the Operation Manual for using the products. Please download it via our website.

Type	EtherCAT® direct input type	EtherNet/IP™ direct input type	PROFINET direct input type	DeviceNet™ direct input type	IO-Link direct input type	CC-Link direct input type	Step data input type
Series	JXCE1	JXC91	JXCP1	JXCD1	JXCL1	JXCM1	JXC51 JXC61
Features	EtherCAT® direct input	EtherNet/IP™ direct input	PROFINET direct input	DeviceNet™ direct input	IO-Link direct input	CC-Link direct input	Parallel I/O
Compatible motor	Battery-less absolute (Step motor 24 VDC)						
Max. number of step data	64 points						
Power supply voltage	24 VDC						

LESYH Series

Battery-less Absolute (Step Motor 24 VDC)

Specifications

Step Motor (Servo/24 VDC)

Model		LESYH8□EA	LESYH8□EB	LESYH8□EC	LESYH16□EA	LESYH16□EB	LESYH25□EA	LESYH25□EB	
Actuator specifications	Stroke [mm]	50, 75			50, 100		50, 100, 150		
	Max. work load [kg] ^{*1 *3}	Horizontal	2			8		12	
		Vertical	1.5	3	6	6	12	10	20
	Pushing force 35% to 70% [N] ^{*2 *3}	18 to 36	37 to 74	69 to 138	91 to 182	174 to 348	109 to 218	210 to 420	
	Max. speed [mm/s] ^{*1 *3}	400	200	100	400	200	400	200	
	Pushing speed [mm/s]	20 to 30	10 to 30	5 to 30	20 to 30	10 to 30	20 to 30	10 to 30	
	Max. acceleration/deceleration [mm/s ²]	5,000							
	Positioning repeatability [mm]	±0.01							
	Lost motion [mm] ^{*4}	0.1 or less							
	Screw lead [mm]	10	5	2.5	12	6	16	8	
	Impact/Vibration resistance [m/s ²] ^{*5}	50/20							
	Actuation type	Ball screw: LESYH□D Ball screw + Belt: LESYH□(R, L)							
	Guide type	Linear guide (Circulating type)							
Operating temperature range [°C]	5 to 40								
Operating humidity range [%RH]	90 or less (No condensation)								
Electric specifications	Motor size	□28		□42		□56			
	Motor type	Step motor (Servo/24 VDC)							
	Encoder (Angular displacement sensor)	Battery-less absolute (4096 pulse/rotation)							
	Rated voltage [V]	24 VDC ±10%							
	Power consumption [W] ^{*6}	23		40		50			
	Standby power consumption when operating [W] ^{*7}	16		15		48			
	Max. instantaneous power consumption [W] ^{*8}	43		48		104			
Lock unit specifications	Type	Non-magnetizing lock							
	Holding force [N]	20	39	78	78	157	108	216	
	Power consumption [W] ^{*10}	2.9		5					
	Rated voltage [V]	24 VDC ±10%							

*1 Speed changes according to the work load. Check the "Speed-Work Load Graph (Guide)" on page 4.

*2 Pushing force accuracy is ±20% (F.S.).

*3 The speed and force may change depending on the cable length, load, and mounting conditions.

Furthermore, if the cable length exceeds 5 m, then it will decrease by up to 10% for each 5 m. (At 15 m: Reduced by up to 20%)

*4 A reference value for correcting errors in reciprocal operation

*5 Vibration resistance: No malfunction occurred in a test ranging between 45 to 2000 Hz. The test was performed in both an axial direction and a perpendicular direction to the lead screw. (The test was performed with the actuator in the initial state.)

Impact resistance: No malfunction occurred when the actuator was tested with a drop tester in both an axial direction and a perpendicular direction to the lead screw. (The test was performed with the actuator in the initial state.)

*6 The power consumption (including the controller) is for when the actuator is operating.

*7 The standby power consumption when operating (including the controller) is for when the actuator is stopped in the set position during the operation. Except during the pushing operation

*8 The max. instantaneous power consumption (including the controller) is for when the actuator is operating. This value can be used for the selection of the power supply.

*9 With lock only

*10 For an actuator with lock, add the power consumption for the lock.

Weight

Product Weight [kg]

Model	Stroke			
	50	75	100	150
LESYH8□E	1.06	1.23	—	—
LESYH16□E	1.87	—	2.26	—
LESYH25□E	3.50	—	4.10	4.90

Additional Weight [kg]

Size	8	16	25
With lock	0.16	0.32	0.61

Dimensions

LESYH8D□E□-□

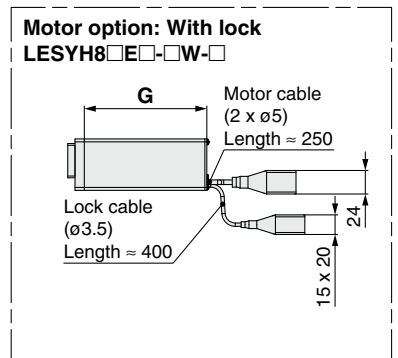
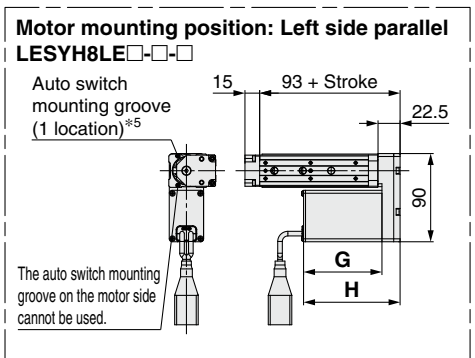
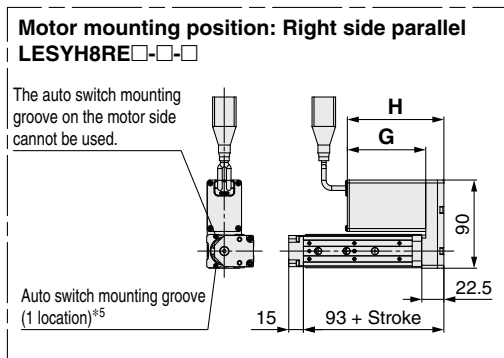
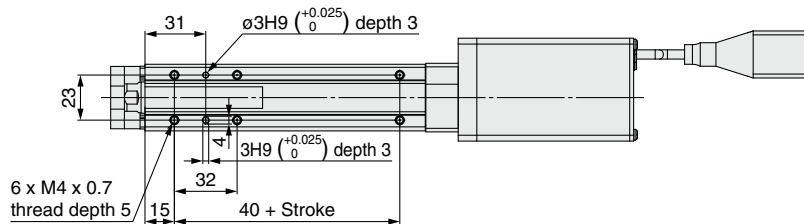
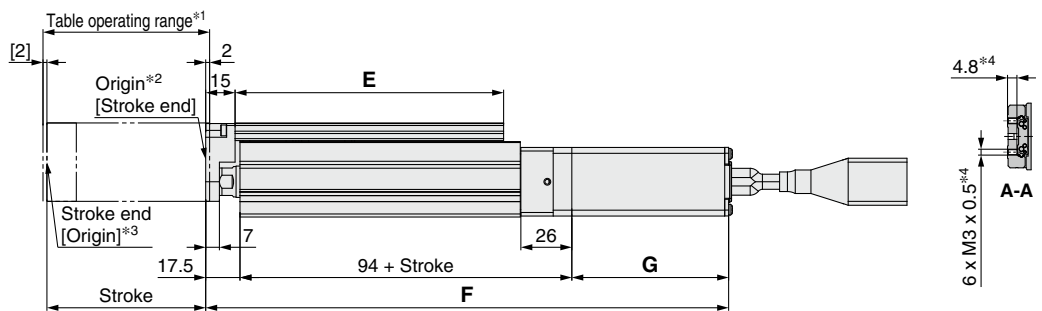
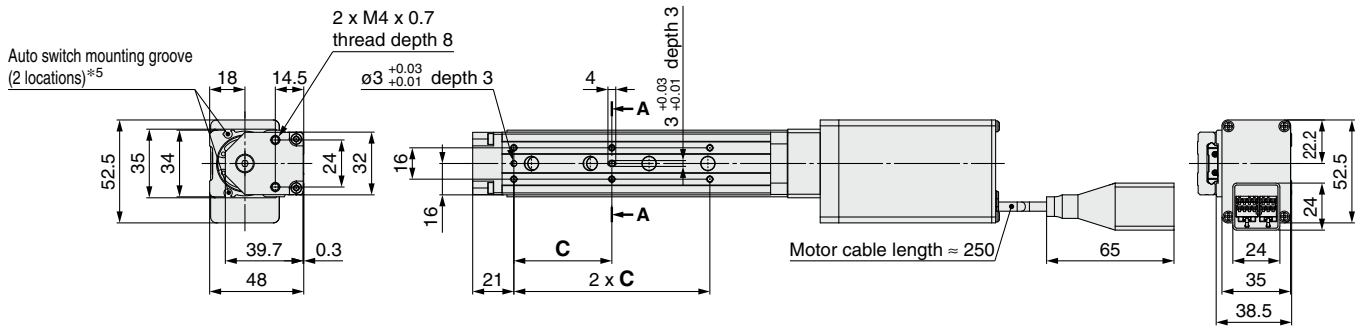

- *1 This is the range within which the table can move when it returns to origin.
Make sure workpieces mounted on the table do not interfere with the workpieces and facilities around the table.
- *2 Position after returning to origin
- *3 [] for when the direction of return to origin has changed
- *4 If the workpiece retaining screws are too long, they may come in contact with the guide block, resulting in a malfunction.
Use screws of a length equal to or shorter than the thread length.
- *5 For checking the limit and the intermediate signal. Applicable to the D-M9□, D-M9□E, and D-M9□W (2-color indicator)
The auto switches should be ordered separately. Refer to the **Web Catalog** for details.

Dimensions

[mm]

Model	Stroke	C	E	Without lock			With lock		
				F	G	H	F	G	H
LESYH8□E□	50	46	111	241.5	80	98.5	286.5	125	143.5
	75	50	137	266.5			311.5		

LESYH Series

Battery-less Absolute (Step Motor 24 VDC)

Dimensions

LESYH16DE□-□

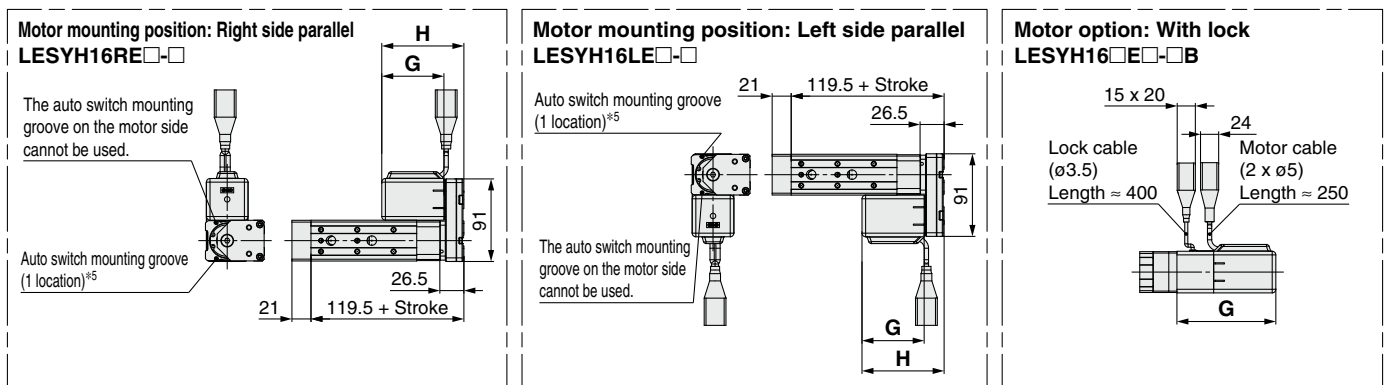
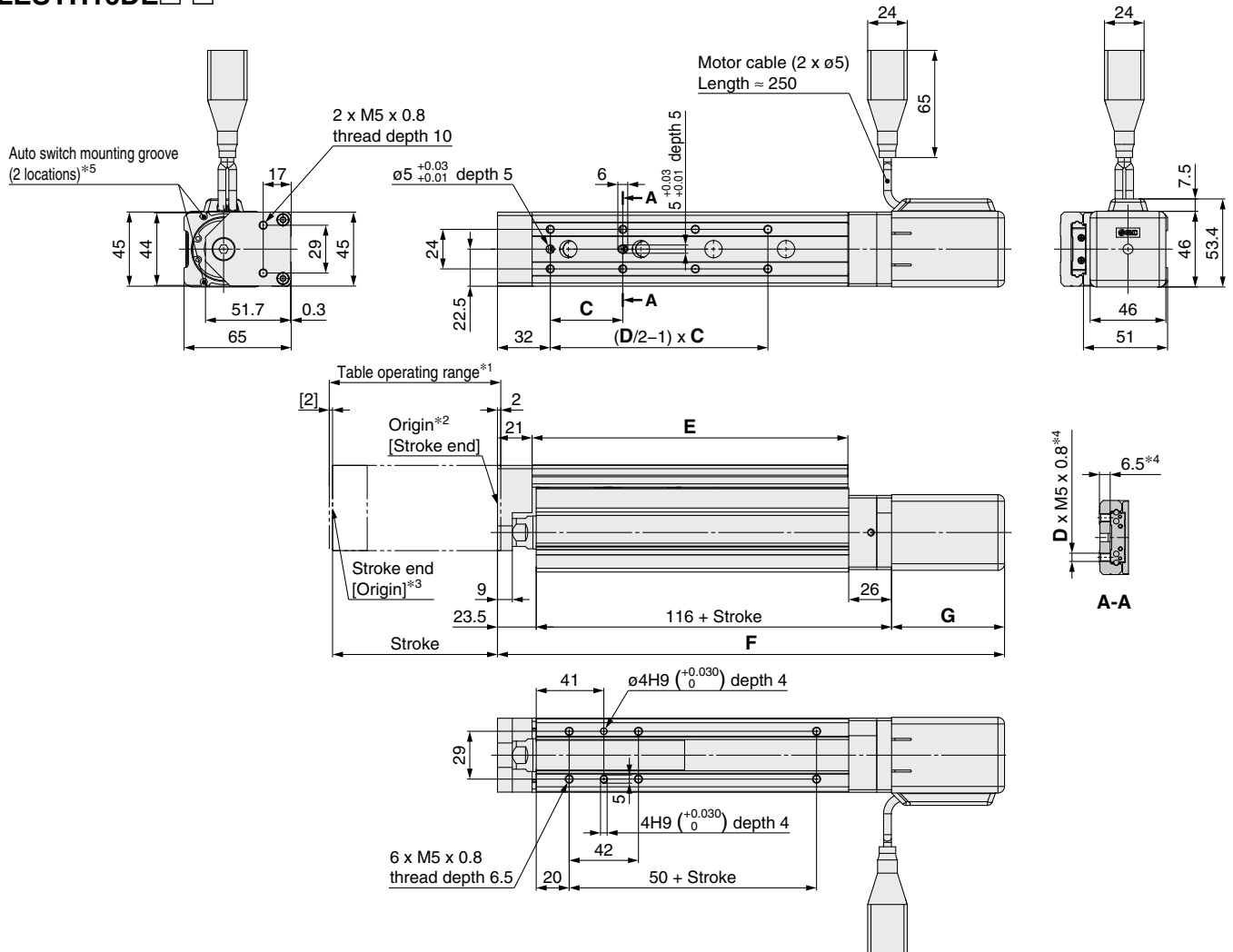

- *1 This is the range within which the table can move when it returns to origin.
Make sure workpieces mounted on the table do not interfere with the workpieces and facilities around the table.
- *2 Position after returning to origin
- *3 [] for when the direction of return to origin has changed
- *4 If the workpiece retaining screws are too long, they may come in contact with the guide block, resulting in a malfunction.
Use screws of a length equal to or shorter than the thread length.
- *5 For checking the limit and the intermediate signal. Applicable to the D-M9□, D-M9□E, and D-M9□W (2-color indicator)
The auto switches should be ordered separately. Refer to the **Web Catalog** for details.

Dimensions

[mm]

Model	Stroke	C	D	E	Without lock			With lock		
					F	G	H	F	G	H
LESYH16□E□	50	40	6	116.5	258	68.5	88.5	298.5	109	129
	100	44	8	191.5	308			348.5		

Dimensions

LESYH25DE□-□

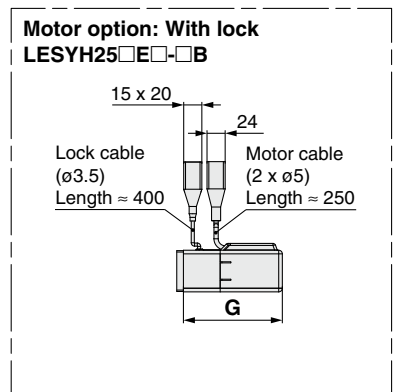
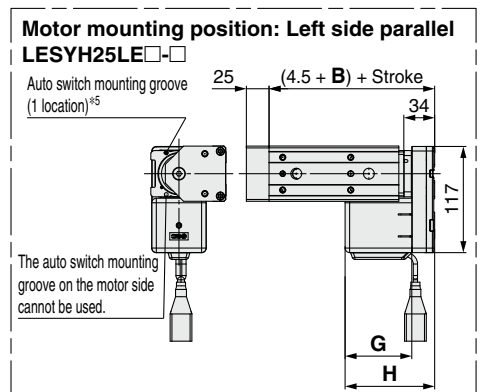
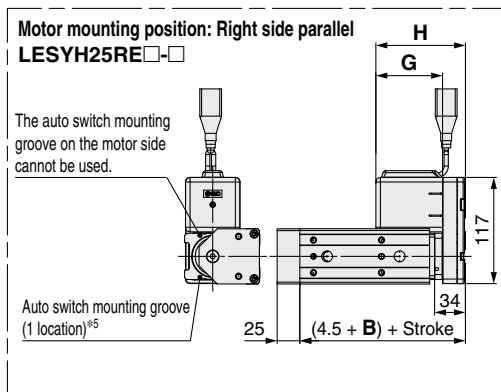
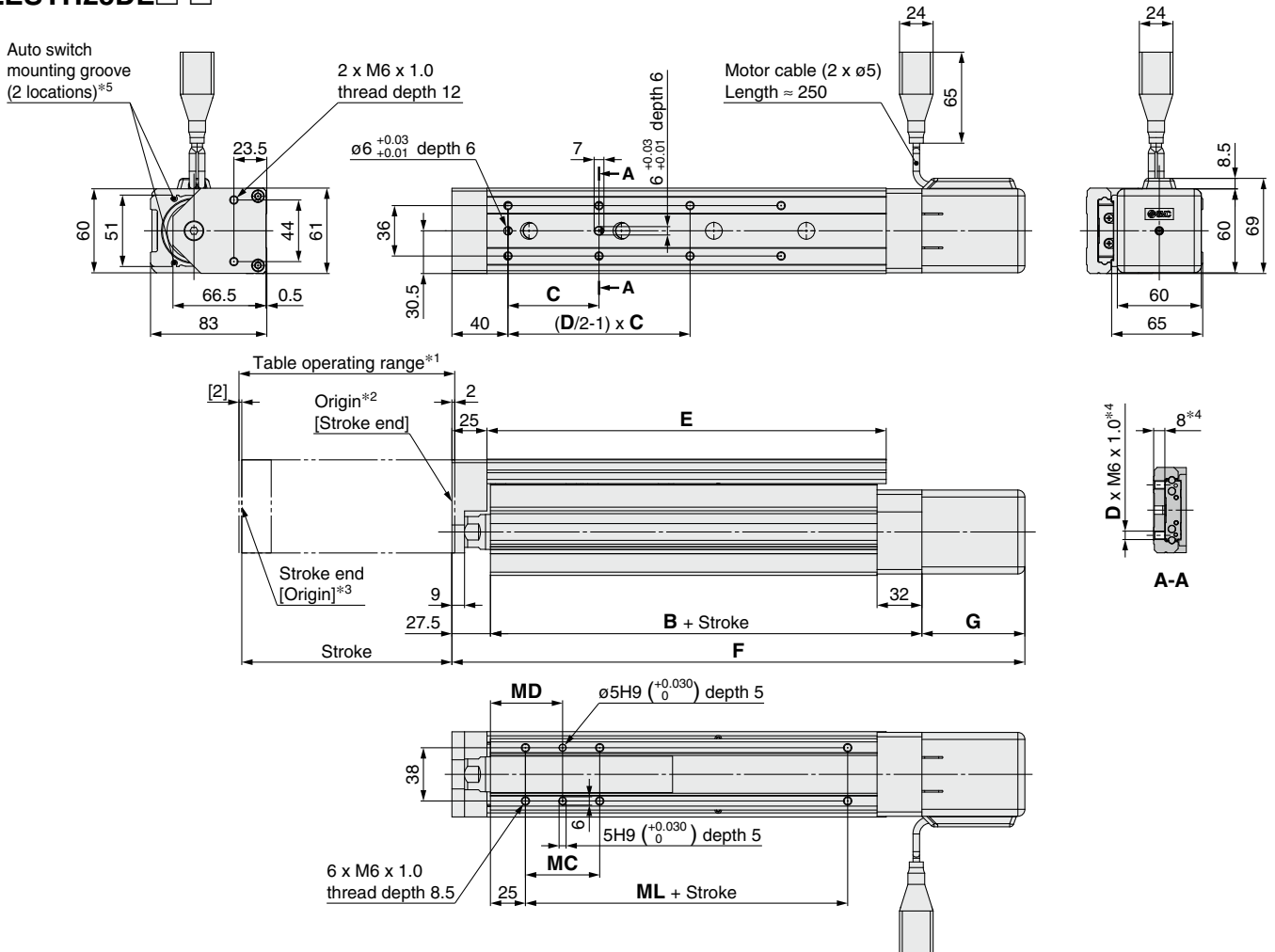

- *1 This is the range within which the table can move when it returns to origin.
Make sure workpieces mounted on the table do not interfere with the workpieces and facilities around the table.
- *2 Position after returning to origin
- *3 [] for when the direction of return to origin has changed
- *4 If the workpiece retaining screws are too long, they may come in contact with the guide block, resulting in a malfunction.
Use screws of a length equal to or shorter than the thread length.
- *5 For checking the limit and the intermediate signal. Applicable to the D-M9□, D-M9□E, and D-M9□W (2-color indicator)
The auto switches should be ordered separately. Refer to the **Web Catalog** for details.

Dimensions

Model	Stroke	B	C	D	E	Without lock			With lock			MC	MD	ML
						F	G	H	F	G	H			
LESYH25□E□	50	128.5	75	4	143	279.5	73.5	98.5	322.5	116.5	141.5	36	43	50
	100		48	207	329.5	372.5								
	150	158.5	65	8	285	409.5	452.5							

Slide Table/High Precision Type

LESYH Series



How to Order

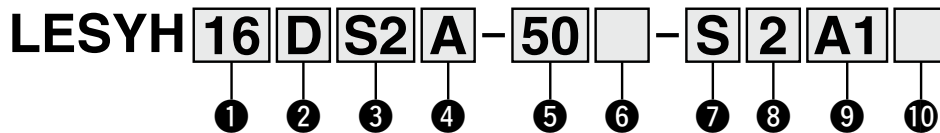

① Size

16
25

② Motor mounting position

D	In-line
R	Right side parallel
L	Left side parallel

③ Motor type

Symbol	Type	Output [W]	Size	Compatible drivers*3
S2 *1	AC servo motor (Incremental encoder)	100	16	LECSA□-S1
S3		200	25	LECSA□-S3
T6 *2	AC servo motor (Absolute encoder)	100	16	LECSB2-T5 LECSC2-T5 LECSS2-T5 LECSN2-T5-□
T7				200

*1 For motor type S2, the compatible driver part number suffix is S1.

*2 For motor type T6, the compatible driver part number is LECS□2-T5.

*3 For details on the driver, refer to the **Web Catalog**.

④ Lead [mm]

	Size	
	16	25 *4
A	12	16 (20)
B	6	8 (10)

*4 The values shown in () are the leads for the right/left side parallel types. (Equivalent leads which include the pulley ratio [1.25:1])

⑤ Stroke [mm]

	Size	
	16	25
50	●	●
100	●	●
150	—	●

⑥ Motor option

Nil	Without lock
B	With lock

⑦ Cable type*5 *6

Nil	Without cable
S	Standard cable
R	Robotic cable (Flexible cable)

*5 A motor cable and encoder cable are included with the product. (A lock cable is also included if motor option "B: With lock" is selected.)

*6 Standard cable entry direction is

- Parallel: (A) Axis side
- In-line: (B) Counter axis side

(Refer to the **Web Catalog** for details.)

⑧ Cable length [m]

Nil	Without cable
2	2
5	5
A	10

For details on auto switches, refer to the **Web Catalog**.



Motor mounting position: Parallel

Motor mounting position: In-line

9 Driver type*7

Symbol	Compatible drivers	Power supply voltage [V]
Nil	Without driver	—
A1	LECSA1-S□	100 to 120
A2	LECSA2-S□	200 to 230
B2	LECSB2-T□	200 to 240
C2	LECSC2-T□	200 to 230
S2	LECSS2-T□	200 to 240
N2	LECSN2-T□	200 to 240
92	LECSN2-T□-9	200 to 240
E2	LECSN2-T□-E	200 to 240
P2	LECSN2-T□-P	200 to 240

*7 When a driver type is selected, a cable is included.

Select the cable type and cable length.

Example)

S2S2: Standard cable (2 m) + Driver (LECSS2)





S2: Standard cable (2 m)

Nil: Without cable and driver

10 I/O cable length [m]

Nil	Without cable
H	Without cable (Connector only)
1	1.5

Compatible Drivers

Driver type	Pulse input type/ Positioning type	Pulse input type	CC-Link direct input type	SSCNET III/H type	Network card type
					
Series	LECSA	LECSB-T	LECSC-T	LECSS-T	LECSN-T
Number of point tables*8	Up to 7	Up to 255	Up to 255 (2 stations occupied)	—	Up to 255
Pulse input	○	○	—	—	—
Applicable network	—	—	CC-Link	SSCNET III/H	PROFINET EtherCAT® EtherNet/IP™
Control encoder	Incremental 17-bit encoder	Absolute 22-bit encoder	Absolute 18-bit encoder	Absolute 22-bit encoder	Absolute 22-bit encoder
Communication function	USB communication	USB communication, RS422 communication	—	USB communication	USB communication
Power supply voltage [V]	100 to 120 VAC (50/60 Hz) 200 to 230 VAC (50/60 Hz)	200 to 240 VAC (50/60 Hz)	200 to 230 VAC (50/60 Hz)	200 to 240 VAC (50/60 Hz)	200 to 240 VAC (50/60 Hz)

*8 The LECSN-T only supports PROFINET and EtherCAT®.

LESYH Series

AC Servo Motor

Specifications: LECSA

* Refer to the next page for the LECSS-T.

Model		LESYH16□S2		LESYH25□S3 (Parallel)		LESYH25DS3 (In-line)			
Actuator specifications	Stroke [mm]	50, 100		50, 100, 150					
	Max. work load [kg]	Horizontal		8		12		12	
		Vertical		6	12	10	20	10	20
	Force [N] ^{*1} (Set value: 15 to 30%)		65 to 131	127 to 255	79 to 157	154 to 308	98 to 197	192 to 385	
	Max. speed [mm/s]		400	200	400	200	400	200	
	Pushing speed [mm/s] ^{1*2}		35 or less		30 or less				
	Max. acceleration/deceleration [mm/s ²]		5,000						
	Positioning repeatability [mm]		±0.01						
	Lost motion ^{*3} [mm]		0.1 or less						
	Lead [mm] (including pulley ratio)		12	6	20	10	16	8	
	Impact/Vibration resistance [m/s ²] ^{*4}		50/20						
	Actuation type		Ball screw + Belt (Parallel), Ball screw (In-line)		Ball screw + Belt [1.25:1]		Ball screw		
	Guide type		Linear guide (Circulating type)						
	Operating temperature range [°C]		5 to 40						
Operating humidity range [%RH]		90 or less (No condensation)							
Regeneration option		May be required depending on speed and work load (Refer to page 10.)							
Electric specifications	Motor output/Size	100 W/□40		200 W/□60					
	Motor type	AC servo motor (100/200 VAC)							
	Encoder	Motor type S2, S3: Incremental 17-bit encoder (Resolution: 131072 p/rev)							
	Power consumption [W] ^{*5}	Horizontal		45		65			
		Vertical		145		175			
	Standby power consumption when operating [W] ^{*6}	Horizontal		2		2			
Vertical		8		8					
Max. instantaneous power consumption [W] ^{*7}	445		724						
Lock unit specifications	Type ^{*8}	Non-magnetizing lock							
	Holding force [N]	131	255	157	308	197	385		
	Power consumption [W] at 20°C ^{*9}	6.3		7.9					
	Rated voltage [V]	24 VDC ⁰ / _{-10%}							

- *1 The force setting range (set values for the driver) for the force control with the torque control mode. Set it while referencing the "Force Conversion Graph" on page 11.
- *2 The allowable collision speed for collision with the workpiece with the torque control mode
- *3 A reference value for correcting errors in reciprocal operation
- *4 Impact resistance: No malfunction occurred when the actuator was tested with a drop tester in both an axial direction and a perpendicular direction to the lead screw. (The test was performed with the actuator in the initial state.)
Vibration resistance: No malfunction occurred in a test ranging between 45 to 2000 Hz. The test was performed in both an axial direction and a perpendicular direction to the lead screw. (The test was performed with the actuator in the initial state.)
- *5 The power consumption (including the driver) is for when the actuator is operating.
- *6 The standby power consumption when operating (including the driver) is for when the actuator is stopped in the set position during the operation.
- *7 The max. instantaneous power consumption (including the driver) is for when the actuator is operating.
- *8 Only when motor option "With lock" is selected
- *9 For an actuator with lock, add the power consumption for the lock.

Weight

Product Weight

[kg]

Model	Stroke		
	50	100	150
LESYH16□S2	1.96	2.35	—
LESYH25□S3	3.83	4.43	5.83

Additional Weight

[kg]

Size	16	25
With lock	0.2	0.4

Specifications: LECS□-T

Model		LESYH16□T6		LESYH25□T7 (Parallel)		LESYH25DT7 (In-line)		
Actuator specifications	Stroke [mm]	50, 100		50, 100, 150				
	Max. work load [kg]	Horizontal	8		12		12	
		Vertical	6	12	10	20	10	20
	Force [N] ^{*1} (Set value: 12 to 24%)	65 to 131	127 to 255	79 to 157	154 to 308	98 to 197	192 to 385	
	Max. speed [mm/s]	400	200	400	200	400	200	
	Pushing speed [mm/s] ^{*2}	35 or less		30 or less				
	Max. acceleration/deceleration [mm/s ²]	5,000						
	Positioning repeatability [mm]	±0.01						
	Lost motion ^{*3} [mm]	0.1 or less						
	Lead [mm] (including pulley ratio)	12	6	20	10	16	8	
	Impact/Vibration resistance [m/s ²] ^{*4}	50/20						
	Actuation type	Ball screw + Belt (Parallel), Ball screw (In-line)		Ball screw + Belt [1.25:1]		Ball screw		
	Guide type	Linear guide (Circulating type)						
Operating temperature range [°C]	5 to 40							
Operating humidity range [%RH]	90 or less (No condensation)							
Regeneration option	May be required depending on speed and work load (Refer to page 10.)							
Electric specifications	Motor output/Size	100 W/□40		200 W/□60				
	Motor type	AC servo motor (200 VAC)						
	Encoder ^{*10}	Motor type T6, T7: Absolute 22-bit encoder (Resolution: 4194304 p/rev) (For LECSB-T□, LECS2-T□, LECSN-T□) Motor type T6, T7: Absolute 18-bit encoder (Resolution: 262144 p/rev) (For LECS2-T□)						
	Power consumption [W] ^{*5}	Horizontal	45		65			
		Vertical	145		175			
	Standby power consumption when operating [W] ^{*6}	Horizontal	2		2			
Vertical		8		8				
Max. instantaneous power consumption [W] ^{*7}	445		724					
Lock unit specifications	Type ^{*8}	Non-magnetizing lock						
	Holding force [N]	131	255	157	308	197	385	
	Power consumption [W] at 20°C ^{*9}	6.3		7.9				
	Rated voltage [V]	24 VDC ⁰ / _{-10%}						

- *1 The force setting range (set values for the driver) for the force control with the torque control mode. Set it while referencing the "Force Conversion Graph" on page 12.
When the control equivalent to the pushing operation of the LECP6 series controller is performed, select the LECS2-T or LECSB2-T driver. The point table no. input method is used for the LECS2-T.
When selecting the LECS2-T, combine it with a Simple Motion module (manufactured by Mitsubishi Electric Corporation) which has a pushing operation function.
- *2 The allowable collision speed for collision with the workpiece with the torque control mode
- *3 A reference value for correcting errors in reciprocal operation
- *4 Impact resistance: No malfunction occurred when the actuator was tested with a drop tester in both an axial direction and a perpendicular direction to the lead screw. (The test was performed with the actuator in the initial state.)
Vibration resistance: No malfunction occurred in a test ranging between 45 to 2000 Hz. The test was performed in both an axial direction and a perpendicular direction to the lead screw. (The test was performed with the actuator in the initial state.)
- *5 The power consumption (including the driver) is for when the actuator is operating.
- *6 The standby power consumption when operating (including the driver) is for when the actuator is stopped in the set position during the operation.
- *7 The max. instantaneous power consumption (including the driver) is for when the actuator is operating.
- *8 Only when motor option "With lock" is selected
- *9 For an actuator with lock, add the power consumption for the lock.
- *10 The resolution will change depending on the driver type.

Weight

Product Weight

[kg]

Model	Stroke		
	50	100	150
LESYH16□T6	2.02	2.41	—
LESYH25□T7	3.77	4.37	5.77

Additional Weight

[kg]

Size	16	25
With lock	0.3	0.4

LESYH Series

AC Servo Motor

Dimensions

LESYH16D^{S2}□-□

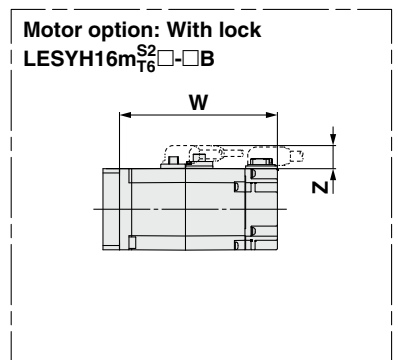
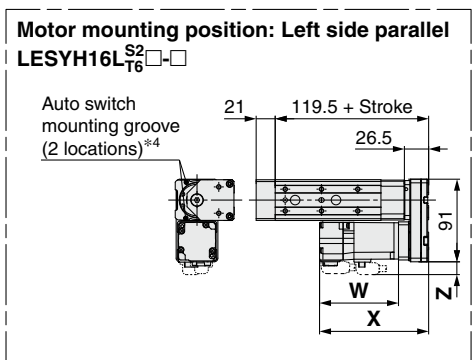
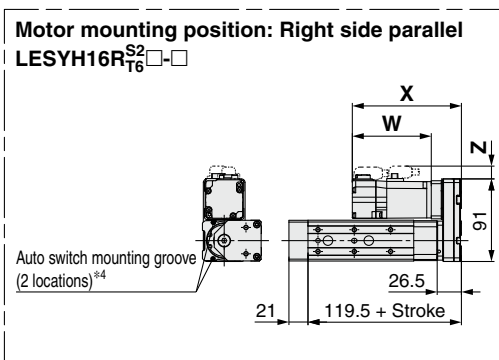
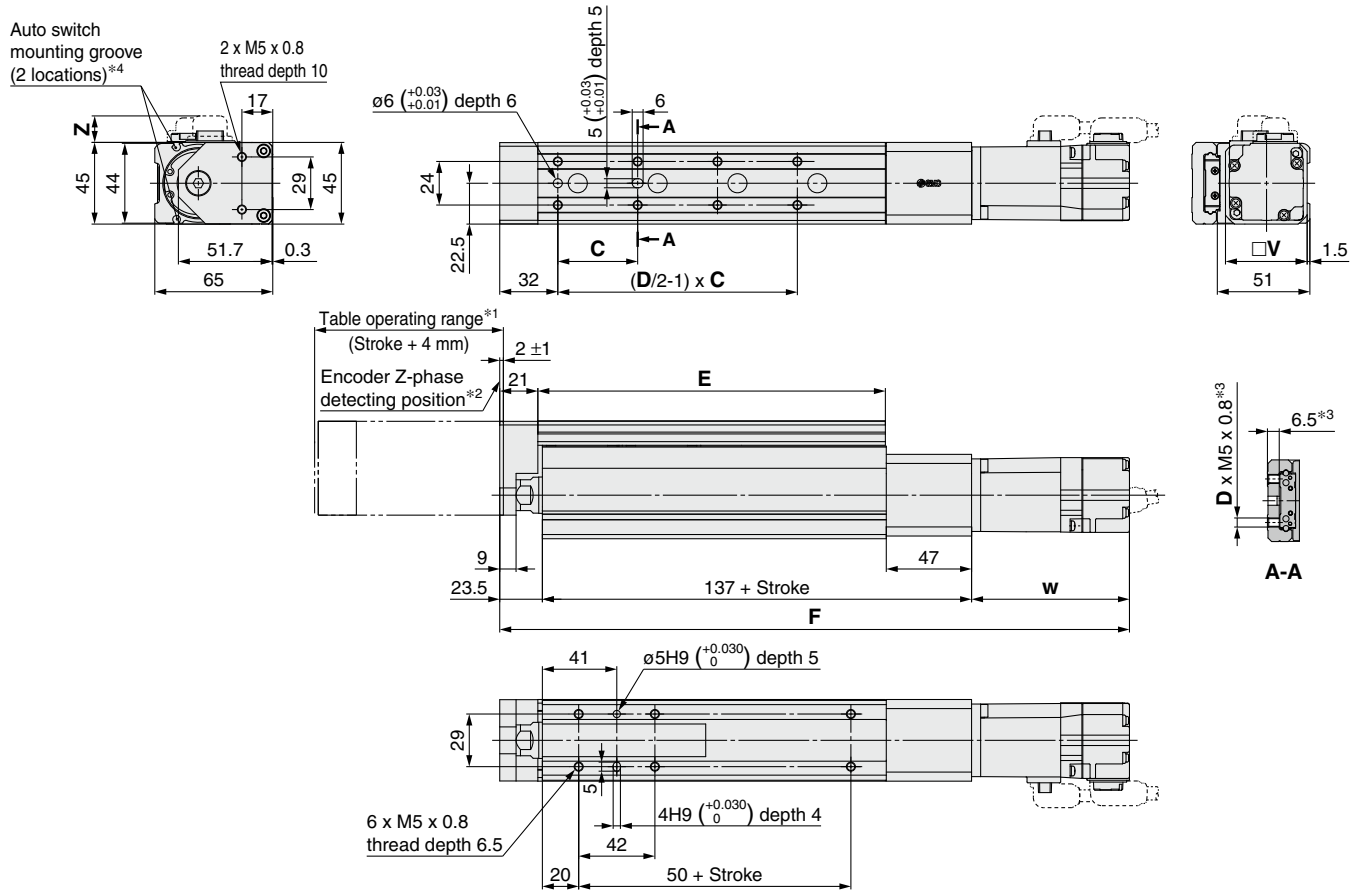

- *1 This is the range within which the table can move when it returns to origin.
Make sure workpieces mounted on the table do not interfere with the workpieces and facilities around the table.
- *2 The Z-phase detecting position from the stroke end
- *3 If the workpiece retaining screws are too long, they may come in contact with the guide block, resulting in a malfunction.
Use screws of a length equal to or shorter than the thread length.
- *4 For checking the limit and the intermediate signal. Applicable to the D-M9□, D-M9□E, and D-M9□W (2-color indicator)
The auto switches should be ordered separately. Refer to the **Web Catalog** for details.

Dimensions

Model	Stroke	C	D	E	Without lock			With lock			Z	
					F	W	X	F	W	X		
LESYH16□S2□	50	40	6	116.5	297.5	87	120	14.6	334.4	123.9	156.9	16.3
	100	44	8	191.5	347.5				384.4			
LESYH16□T6□	50	40	6	116.5	292.9	82.4	115.4	14.6	334	123.5	156	16.3
	100	44	8	191.5	342.9				384			

Dimensions

LESYH25D^{S3}_{T7}□-□

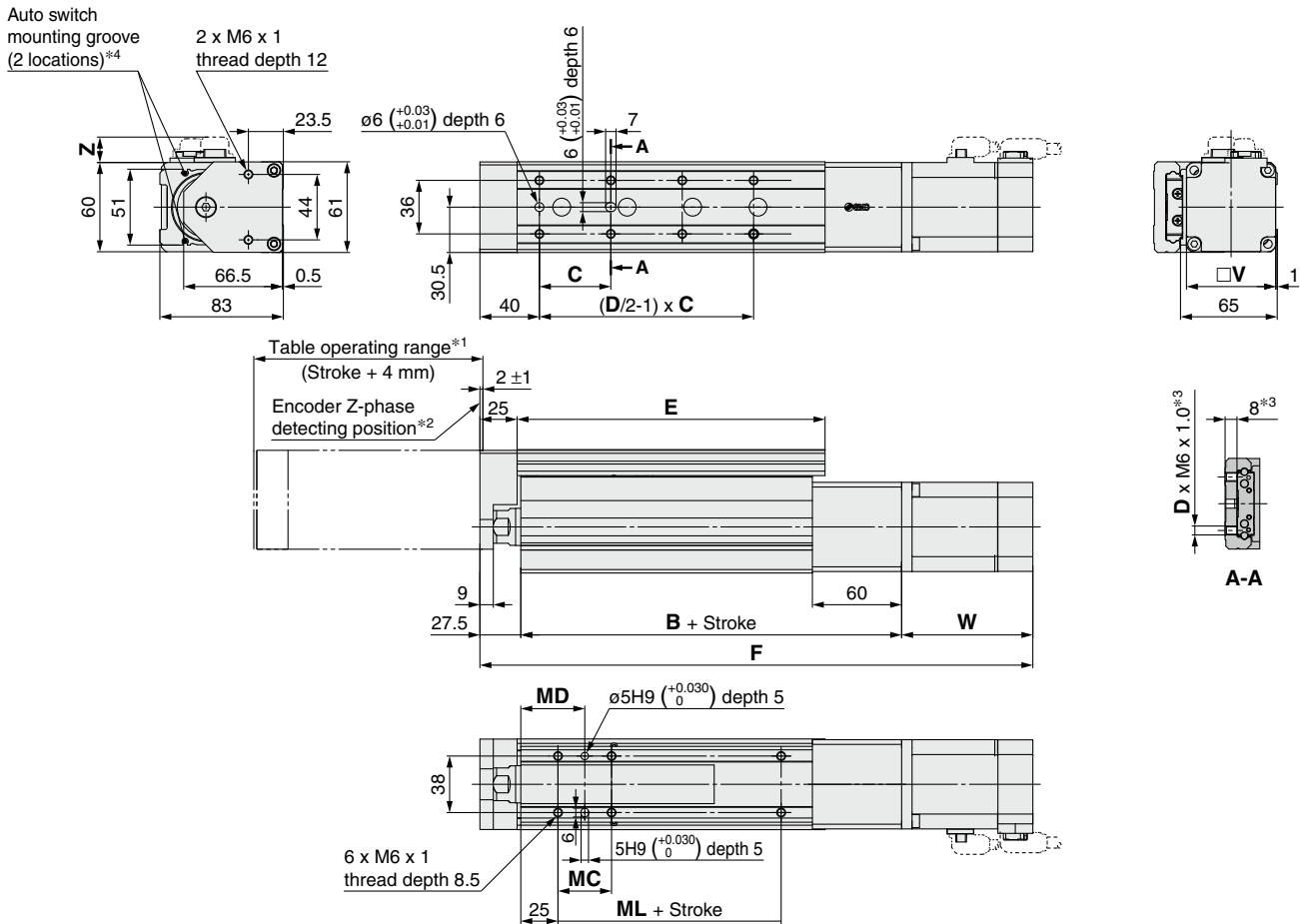

Motor mounting position: Right side parallel LESYH25R^{S3}_{T7}□-□

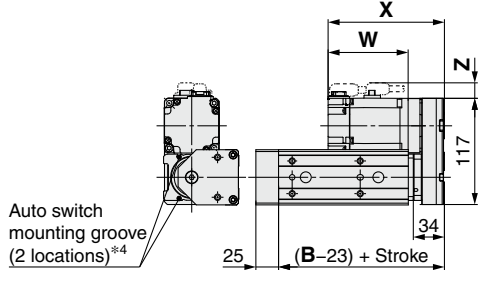

Motor mounting position: Left side parallel LESYH25L^{S3}_{T7}□-□

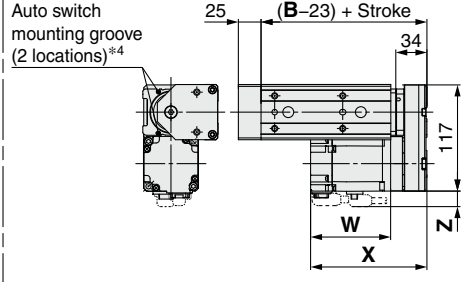

Motor option: With lock LESYH25□^{S3}_{T7}□-□B

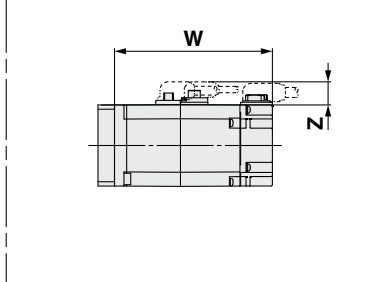

- *1 This is the range within which the table can move when it returns to origin.
Make sure workpieces mounted on the table do not interfere with the workpieces and facilities around the table.
- *2 The Z-phase detecting position from the stroke end
- *3 If the workpiece retaining screws are too long, they may come in contact with the guide block, resulting in a malfunction.
Use screws of a length equal to or shorter than the thread length.
- *4 For checking the limit and the intermediate signal. Applicable to the D-M9□, D-M9□E, and D-M9□W (2-color indicator)
The auto switches should be ordered separately. Refer to the **Web Catalog** for details.

Dimensions

Model	Stroke	B	C	D	E	Without lock				With lock				MC	MD	ML
						F	W	X	Z	F	W	X	Z			
LESYH25□S3□	50	156.3	75	4	143	322	88.2	128.2	17.1	350.6	116.8	156.8	17.1	36	43	50
	100		48	207	400.6					53				51.5	80	
	150		65	285	480.6					53				51.5	80	
LESYH25□T7□	50	156.3	75	4	143	310.4	76.6	116.6	17.1	347.2	113.4	153.4	17.1	36	43	50
	100		48	207	397.2					53				51.5	80	
	150		65	285	477.2					53				51.5	80	

Slide Table/High Precision Type

LESYH Series



How to Order

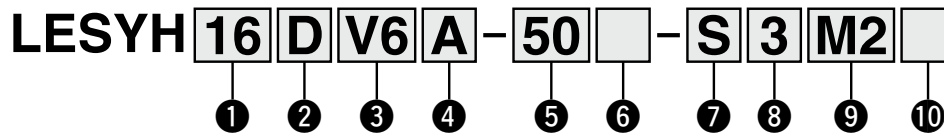

① Size

16
25

② Motor mounting position

D	In-line
R	Right side parallel
L	Left side parallel

③ Motor type

Symbol	Type	Output [W]	Actuator size	Compatible drivers
V6 *1	AC servo motor (Absolute encoder)	100	16	LECYM2-V5 LECYU2-V5
V7		200	25	LECYM2-V7 LECYU2-V7

*1 For motor type V6, the compatible driver part number suffix is V5.

④ Lead [mm]

	Size	
	16	25 *2
A	12	16 (20)
B	6	8 (10)

*2 The values shown in () are the leads for the right/left side parallel types. (Equivalent leads which include the pulley ratio [1.25:1])

⑤ Stroke [mm]

	Size	
	16	25
50	●	●
100	●	●
150	—	●

⑥ Motor option

Nil	Without option
B	With lock

⑦ Cable type*3

Nil	Without cable
S	Standard cable
R	Robotic cable (Flexible cable)

*3 A motor cable and encoder cable are included with the product.
A motor cable for lock option is included if motor option "B: With lock" is selected.

⑧ Cable length [m]*4

Nil	Without cable
3	3
5	5
A	10

*4 The length of the motor and encoder cables are the same. (For with lock)

For details on auto switches, refer to the **Web Catalog**.



Motor mounting position: Parallel



Motor mounting position: In-line

9 Driver type*5

Symbol	Compatible drivers	Power supply voltage [V]
Nil	Without driver	—
M2	LECYM2-V□	200 to 230
U2	LECYU2-V□	200 to 230

*5 When a driver type is selected, a cable is included.
Select the cable type and cable length.

10 I/O cable length [m]*6

Nil	Without cable
H	Without cable (Connector only)
1	1.5

*6 When “Nil: Without driver” is selected for the driver type, only “Nil: Without cable” can be selected. Refer to the **Web Catalog** if an I/O cable is required.
(Options are shown in the **Web Catalog**.)

Compatible Drivers

Driver type		
	LECYM	LECYU
Applicable network	MECHATROLINK-II	MECHATROLINK-III
Control encoder	Absolute 20-bit encoder	
Communication device	USB communication, RS-422 communication	
Power supply voltage [V]	200 to 230 VAC (50/60 Hz)	

LESYH Series

AC Servo Motor

Specifications

Model		LESYH16□V6		LESYH25□V7 (Parallel)		LESYH25DV7 (In-line)		
Actuator specifications	Stroke [mm]	50, 100		50, 100, 150				
	Max. work load [kg]	Horizontal	8		12		12	
		Vertical	6	12	10	20	10	20
	Force [N]* ¹ (Set value: 45 to 90%)	65 to 131	127 to 255	79 to 157	154 to 308	98 to 197	192 to 385	
	Max. speed [mm/s]	400	200	400	200	400	200	
	Pushing speed [mm/s]* ²	35 or less		30 or less				
	Max. acceleration/deceleration [mm/s ²]	5,000						
	Positioning repeatability [mm]	±0.01						
	Lost motion* ³ [mm]	0.1 or less						
	Lead [mm] (including pulley ratio)	12	6	20	10	16	8	
	Impact/Vibration resistance [m/s ²]* ⁴	50/20						
	Actuation type	Ball screw + Belt (Parallel), Ball screw (In-line)		Ball screw + Belt [1.25:1]		Ball screw		
	Guide type	Linear guide (Circulating type)						
	Operating temperature range [°C]	5 to 40						
	Operating humidity range [%RH]	90 or less (No condensation)						
Required conditions for the regenerative resistor* ⁵ [kg]	Horizontal	6 or more		4 or more				
	Vertical							
Motor output/Size	100 W/□40		200 W/□60					
Motor type	AC servo motor (200 VAC)							
Encoder	Absolute 20-bit encoder (Resolution: 1048576 p/rev)							
Power consumption [W]* ⁶	Horizontal	45		65				
	Vertical	145		175				
Standby power consumption when operating [W]* ⁷	Horizontal	2		2				
	Vertical	8		8				
Max. instantaneous power consumption [W]* ⁸	445		724					
Type* ⁹	Non-magnetizing lock							
Holding force [N]	131	255	157	308	197	385		
Power consumption [W] at 20°C* ¹⁰	5.5		6					
Rated voltage [V]	24 VDC ^{+10%} / ₀							

- *1 The force setting range (set values for the driver) for the force control with the torque control mode. Set it while referencing the "Force Conversion Graph" on page 16.
- *2 The allowable collision speed for collision with the workpiece with the torque control mode
- *3 A reference value for correcting errors in reciprocal operation
- *4 Impact resistance: No malfunction occurred when the actuator was tested with a drop tester in both an axial direction and a perpendicular direction to the lead screw. (The test was performed with the actuator in the initial state.)
Vibration resistance: No malfunction occurred in a test ranging between 45 to 2000 Hz. The test was performed in both an axial direction and a perpendicular direction to the lead screw. (The test was performed with the actuator in the initial state.)
- *5 The work load conditions which require the regenerative resistor when operating at the max. speed (Duty ratio: 100%). Order the regenerative resistor separately. For details, refer to the "Required Conditions for the Regenerative Resistor (Guide)" on page 15.
- *6 The power consumption (including the driver) is for when the actuator is operating.
- *7 The standby power consumption when operating (including the driver) is for when the actuator is stopped in the set position during the operation.
- *8 The max. instantaneous power consumption (including the driver) is for when the actuator is operating.
- *9 Only when motor option "With lock" is selected
- *10 For an actuator with lock, add the power consumption for the lock.

Weight

Product Weight

[kg]

Model	Stroke		
	50	100	150
LESYH16□V6	1.85	2.24	—
LESYH25□V7	3.68	4.28	5.68

Additional Weight

[kg]

Size	16	25
With lock	0.3	0.6

Slide Table/ High Precision Type

LESYH Series LESYH16, 25



How to Order

LESYH **16** **D** **NZ** **A** - **50**

① ② ③ ④ ⑤

① Size

16
25

② Motor mounting position

D	In-line
R	Right side parallel
L	Left side parallel

④ Lead [mm]

	Size	
	16	25*1
A	12	16 (20)
B	6	8 (10)

*1 The values shown in () are the leads for the right/left side parallel types. Except motor type NM1 (Equivalent leads which include the pulley ratio [1.25:1])

⑤ Stroke [mm]

	Size	
	16	25
50	●	●
100	●	●
150	—	●

③ Motor type

Applicable motor model			Size/Motor type														
Manufacturer	Series	Type	16						25								
			NZ Mounting type Z	NY Mounting type Y	NX Mounting type X	NM1 Mounting type M1M	NM2 Mounting type M2	NM3 Mounting type M3	NZ Mounting type Z	NY Mounting type Y	NX Mounting type X	NW Mounting type W	NV Mounting type V	NU Mounting type U	NT Mounting type T	NM1 Mounting type M1	NM2 Mounting type M2
Mitsubishi Electric Corporation	MELSERVO-JN	HF-KN	●	—	—	—	—	—	●	—	—	—	—	—	—	—	—
	MELSERVO-J4	HG-KR	●	—	—	—	—	—	●	—	—	—	—	—	—	—	
	MELSERVO-J5	HK-KT	●	—	—	—	—	—	●	—	—	—	—	—	—	—	
YASKAWA Electric Corporation	Σ-V	SGMJV	●	—	—	—	—	—	●	—	—	—	—	—	—	—	
	Σ-7	SGM7J/SGM7A	●	—	—	—	—	—	●	—	—	—	—	—	—	—	
SANYO DENKI CO., LTD.	SANMOTION R	R2	●	—	—	—	—	—	●	—	—	—	—	—	—	—	
OMRON Corporation	Sysmac G5	R88M-K	●	—	—	—	—	—	—	●	—	—	—	—	—	—	
	1 S	R88M-1	●	—	—	—	—	—	—	●	—	—	—	—	—	—	
Panasonic Corporation	MINAS A5	MSM□/MHMD	—	●	—	—	—	—	—	●	—	—	—	—	—	—	
		MMSF	—	●	—	—	—	—	—	●	—	—	—	—	—	—	
	MINAS A6	MHMF	●	—	—	—	—	—	—	●	—	—	—	—	—	—	
FANUC CORPORATION	β is (-B)	β	●	—	—	—	—	—	●	—	—	●	—	—	—	—	
NIDEC SANKYO CORPORATION	S-FLAG	MA/MH/MM	●	—	—	—	—	—	●	—	—	—	—	—	—	—	
KEYENCE CORPORATION	SV	SV-M/SV-B	●	—	—	—	—	—	●	—	—	—	—	—	—	—	
	SV2	SV2-M/SV2-B	●	—	—	—	—	—	●	—	—	—	—	—	—	—	
FUJI ELECTRIC CO., LTD.	ALPHA5	GYS/GYB	●	—	—	—	—	—	●	—	—	—	—	—	—	—	
	ALPHA7	GYS/GYB	●	—	—	—	—	—	●	—	—	—	—	—	—	—	
	FALDIC α	GYS	●	—	—	—	—	—	●	—	—	—	—	—	—	—	
MinebeaMitsumi Inc.	SZ	A17PM/A23KM	—	—	—	●*1	—	—	—	—	—	—	—	—	—	●*2	
Shinano Kenshi Co., Ltd.	CSB-BZ	CSB-BZ	—	—	—	●*1	—	—	—	—	—	—	—	—	—	—	
ORIENTAL MOTOR Co., Ltd.	AR/AZ	AR/AZ (46 only)	—	—	—	—	—	●	—	—	—	—	—	—	—	—	
	AR/AZ	AR/AZ	—	—	—	—	—	—	—	—	—	—	—	—	—	●	
FASTECH Co., Ltd.	Ezi-SERVO	EzM	—	—	—	●	—	—	—	—	—	—	—	—	—	●	
Rockwell Automation, Inc. (Allen-Bradley)	MP-/VP-	MP/VP	—	—	—	—	—	—	—	—	●*1	—	—	—	—	—	
	TL	TLY-A	●	—	—	—	—	—	—	—	—	—	—	●	—	—	
Beckhoff Automation GmbH	AM	AM30	●	—	—	—	—	—	—	—	—	—	●*1	—	—	—	
	AM	AM31	●	—	—	—	—	—	—	—	—	—	—	●	—	—	
	AM	AM80/AM81	●	—	—	—	—	—	—	—	●*1	—	—	—	—	—	
Siemens AG	1FK7	1FK7	—	—	●	—	—	—	—	—	●*1	—	—	—	—	—	
Delta Electronics, Inc.	ASDA-A2	ECMA	●	—	—	—	—	—	●	—	—	—	—	—	—	—	
ANCA Motion	AMD2000	Alpha	●	—	—	—	—	—	●	—	—	—	—	—	—	—	

*1 Motor mounting position: In-line only *2 Motor mounting position: Parallel only

LESYH Series

Motorless Type

Specifications

Model		LESYH16		LESYH25 (Parallel)		LESYH25 (In-line)		
Actuator specifications	Stroke [mm]	50, 100		50, 100, 150				
	Work load [kg]	Horizontal*1	8		12		12	
		Vertical	6	12	10	20	10	20
	Force [N]*2 (Set value: Rated torque 45 to 90%)	65 to 131	127 to 255	79 to 157	154 to 308	98 to 197	192 to 385	
	Max. speed [mm/s]	400	200	400	200	400	200	
	Pushing speed [mm/s]*3	35 or less		30 or less				
	Max. acceleration/deceleration [mm/s ²]	5000						
	Positioning repeatability [mm]	±0.01						
	Lost motion [mm]*4	0.1 or less						
	Ball screw specifications	Thread size [mm]	ø10		ø12			
		Lead [mm] (including pulley ratio)	12	6	16 (20)	8 (10)	16	8
		Shaft length [mm]	Stroke + 93.5		Stroke + 104.5			
	Impact/Vibration resistance [m/s ²]*5	50/20						
Actuation type	Ball screw + Belt (Parallel) Ball screw (In-line)		Ball screw + Belt [Pulley ratio 1.25:1]		Ball screw			
Guide type	Linear guide (Circulating type)							
Operating temperature range [°C]	5 to 40							
Operating humidity range [%RH]	90 or less (No condensation)							
Other specifications*6	Actuation unit weight [kg]	50 st	0.585	1.21				
		100 st	0.919	1.68				
		150 st	—	2.19				
	Other inertia [kg·cm ²]	0.012 (LESYH16) 0.015 (LESYH16D)		0.035 (LESYH25) 0.061 (LESYH25D)				
	Friction coefficient	0.05						
Mechanical efficiency	0.8							
Reference motor specifications	Motor shape	□40		□60				
	Motor type	AC servo motor						
	Rated output capacity [W]	100		200				
	Rated torque [N·m]	0.32		0.64				
	Rated rotation [rpm]	3000						

*1 This is the max. value of the horizontal work load. An external guide is necessary to support the load (Friction coefficient of guide: 0.1 or less). The actual work load changes according to the condition of the external guide. Confirm the load using the actual device.

*2 The force setting range for the force control (Speed control mode, Torque control mode)

The force changes according to the set value. Set it with reference to the "Force Conversion Graph (Guide)" on page 21.

*3 The allowable collision speed for collision with the workpiece

*4 A reference value for correcting errors in reciprocal operation

*5 Impact resistance: No malfunction occurred when the actuator was tested with a drop tester in both an axial direction and a perpendicular direction to the lead screw. (The test was performed with the actuator in the initial state.)

Vibration resistance: No malfunction occurred in a test ranging between 45 to 2000 Hz. The test was performed in both an axial direction and a perpendicular direction to the lead screw. (The test was performed with the actuator in the initial state.)

*6 Each value is only to be used as a guide to select a motor of the appropriate capacity.

Weight

[kg]

Model	Stroke		
	50	100	150
LESYH16	1.48	1.87	—
LESYH25	2.77	3.37	4.77

Dimensions

LESYH16D□-□

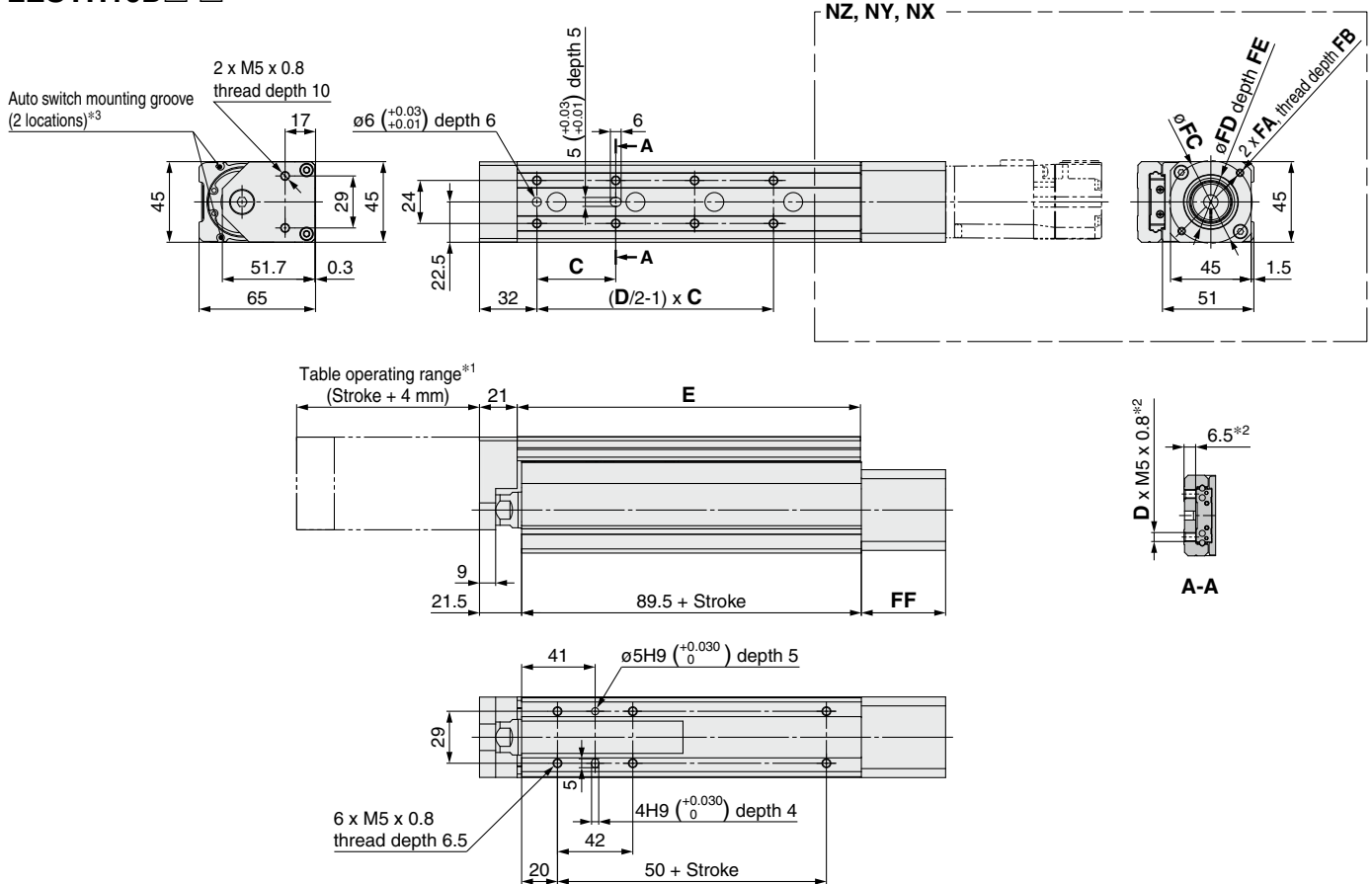

Dimensions

Model	Stroke	C	D	E
LESYH16□□-50	50	40	6	116.5
LESYH16□□-100	100	44	8	191.5

Size	Motor type	FA	FB	FC	FD	FE	FF	FG	FH
LESYH16	NZ, NX	M4 x 0.7	7.5	46	30	3.7	47	45	—
	NY	M3 x 0.5	6	45	30	4.2	47	45	—
	NM1	ø3.4	17	31	22	2.5	36	45	19
	NM2	ø3.4	28	31	22	2.5	47	45	30

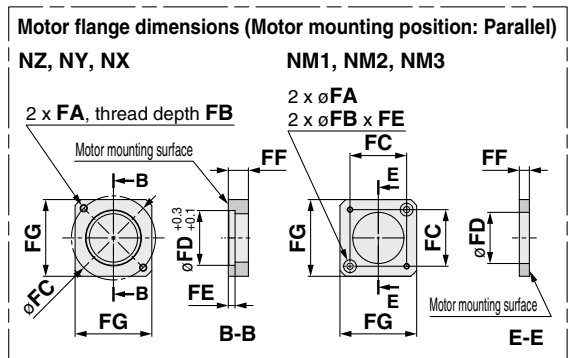
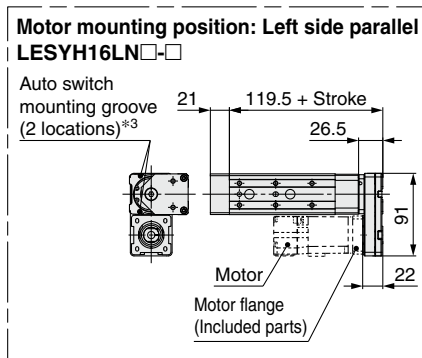
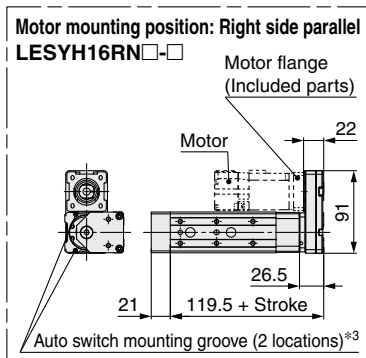
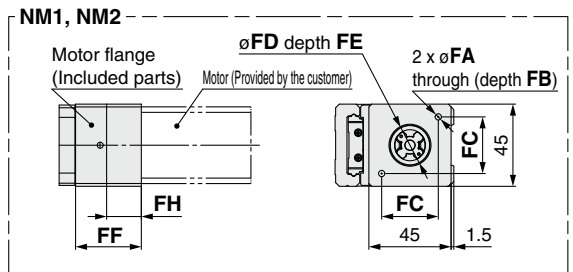

- *1 This is the range within which the table can move when it returns to origin. Make sure workpieces mounted on the table do not interfere with the workpieces and facilities around the table.
- *2 If the workpiece retaining screws are too long, they may come in contact with the guide block, resulting in a malfunction. Use screws of a length equal to or shorter than the thread length.
- *3 For checking the limit and the intermediate signal. Applicable to the D-M9□, D-M9□E, and D-M9□W (2-color indicator). The auto switches should be ordered separately.

Dimensions

Size	Motor type	FA	FB	FC	FD	FE	FF	FG
LESYH16	NZ	M4 x 0.7	7.5	46	30	3.7	11	42
	NY	M3 x 0.5	5.5	45	30	5	11	38
	NX	M4 x 0.7	7	46	30	3.7	8	42
	NM1/ NM2	ø3.4	7	31	28	3.5	8.5	42
	NM3	ø3.4	7	31	28	3.5	5.5	42

LESYH Series

Motorless Type

Dimensions

LESYH25D□-□

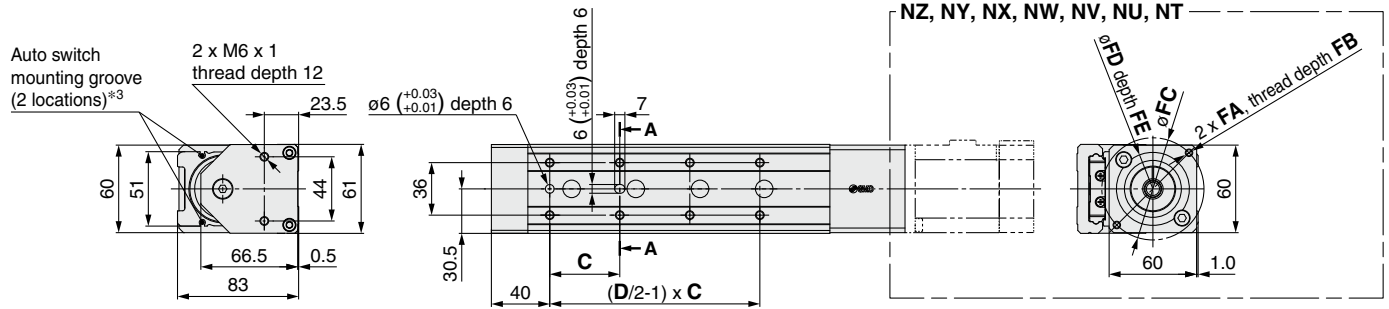
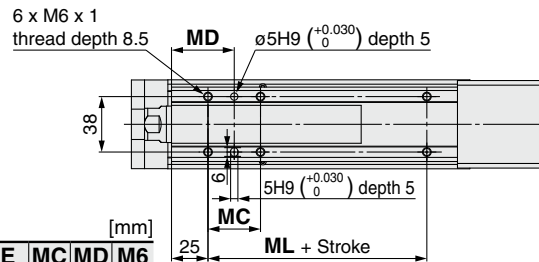
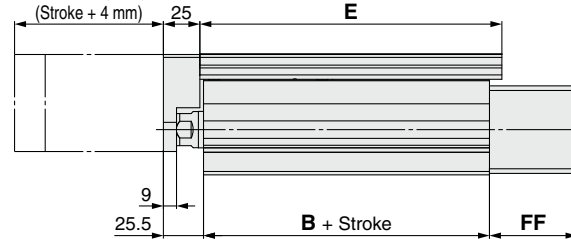

Table operating range*1
(Stroke + 4 mm)



Dimensions

Model	Stroke	B	C	D	E	MC	MD	M6
LESYH25□□-50	50		75	4	143			
LESYH25□□-100	100	156.3	48	8	207	36	43	50
LESYH25□□-150	150	186.3	68		285	53	51.5	80

Size	Motor type	[mm]							
		FA	FB	FC	FD	FE	FF	FG	FH
LESYH25	NZ, NW, NU, NT	M5 x 0.8	8.5	70	50	3.3	60	60	—
	NY	M4 x 0.7	8	70	50	3.3	60	60	—
	NX	M5 x 0.8	8.5	63	40	3.5	63	60	—
	NV	M4 x 0.7	8	63	40	3.3	63	60	—
	NM1	M4 x 0.7	9.5	47.14	38.1	2	34	60	51.5
	NM2	M4 x 0.7	8	50	36	3.3	60	60	—

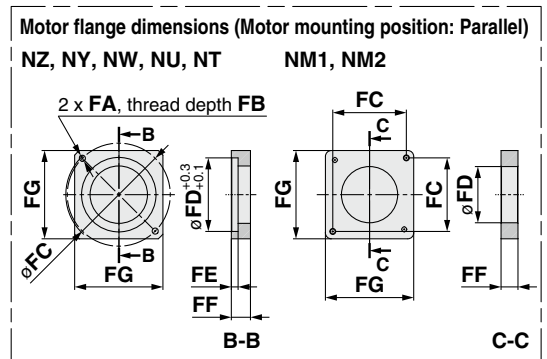
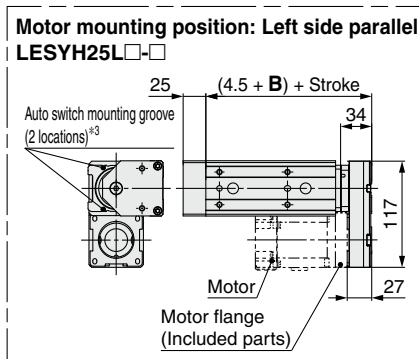
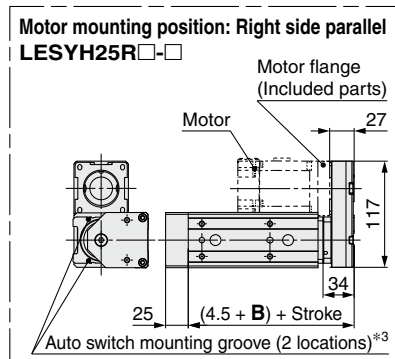
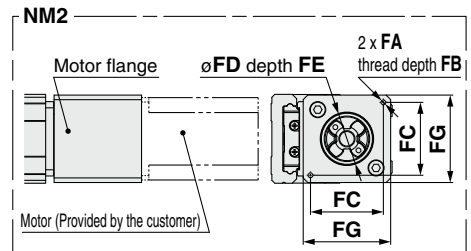
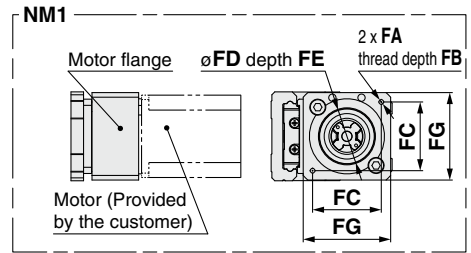

- *1 This is the range within which the table can move when it returns to origin. Make sure workpieces mounted on the table do not interfere with the workpieces and facilities around the table.
- *2 If the workpiece retaining screws are too long, they may come in contact with the guide block, resulting in a malfunction. Use screws of a length equal to or shorter than the thread length.
- *3 For checking the limit and the intermediate signal. Applicable to the D-M9□, D-M9□E, and D-M9□W (2-color indicator). The auto switches should be ordered separately. Refer to the **Web Catalog** for details.

Dimensions

Size	Motor type	[mm]						
		FA	FB	FC	FD	FE	FF	FG
LESYH25	NZ/NW/NU	M5 x 0.8	8.5	70	50	4.6	13	60
	NY	M4 x 0.7	7	70	50	4.6	13	60
	NT	M5 x 0.8	8.5	70	50	4.6	17	60
	NM1	M4 x 0.7	(5)	47.1	38.2	—	5	56.4
	NM2	M4 x 0.7	8	50	38.2	—	11.5	60

Slide Table/High Precision Type **LESYH Series**

Motorless Type

- The motor and motor mounting screws should be provided by the customer.
- Motor shaft type should be cylindrical for the NZ, NY, NW, NM2 motor types, and D-cut type for the NM1 and NM3 motor type.
- When mounting a pulley, remove all oil content, dust, and dirt adhered to the shaft and the inside of the pulley.
- Take measures to prevent the loosening of the motor mounting screws and hexagon socket head set screws.

Motor Mounting: Parallel

LESYH16
25

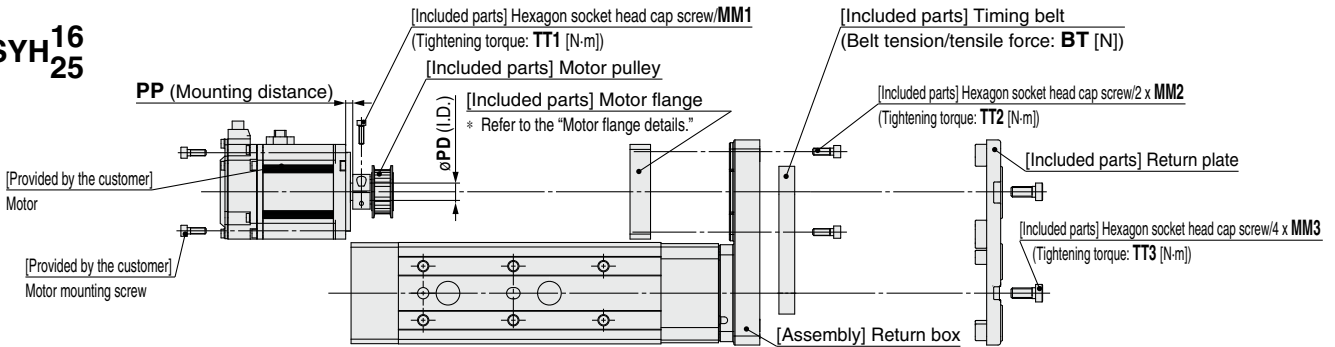

LESYH16: NM1, NM2, NM3

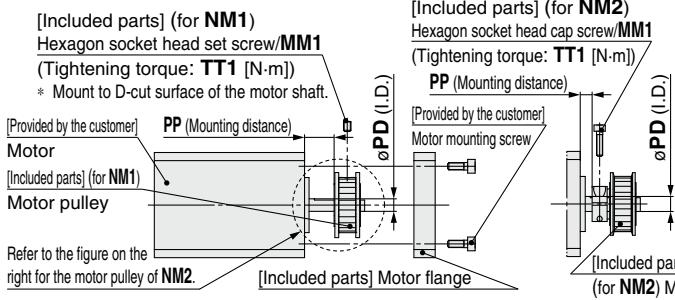

LESYH25: NM1

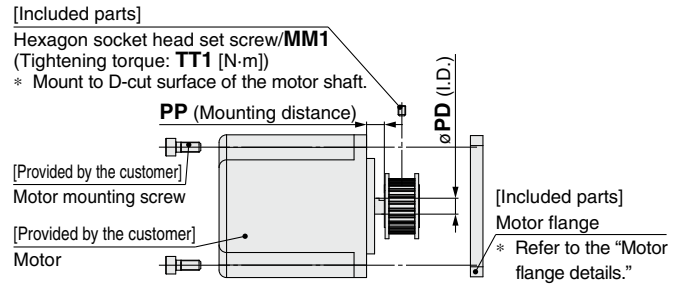

Motor flange details

LESYH16: NZ, NY, NX

LESYH25: NZ, NY, NW, NU, NT

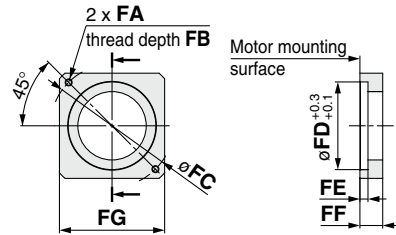

LESYH16: NM1, NM2, NM3

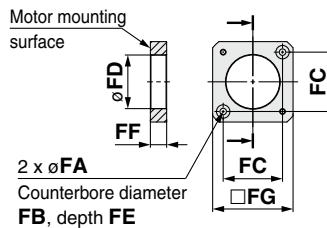

LESYH25: NM1, NM2

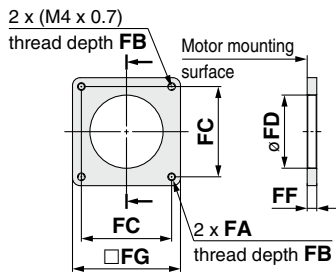

Dimensions

Size	Motor type	MM1	TT1	MM2	TT2	MM3	TT3	PD	PP	BT	FA	FB	FC	FD	FE	FF	FG
16	NZ	M2.5 x 10	1.0	M3 x 8	0.63	M4 x 10	1.5	8	7.5	19	M4 x 0.7	7.5	46	30	3.7	11	42
	NY	M2.5 x 10	1.0	M3 x 8	0.63	M4 x 10	1.5	8	7.5	19	M3 x 0.5	5.5	45	30	5	11	38
	NX	M2.5 x 10	1.0	M3 x 8	0.63	M4 x 10	1.5	8	4.5	19	M4 x 0.7	7	46	30	3.7	8	42
	NM1	M3 x 5	0.63	M3 x 8	0.63	M4 x 10	1.5	5	11.8	19	ø3.4	7	31	28	3.5	8.5	42
	NM2	M2.5 x 10	1.0	M3 x 8	0.63	M4 x 10	1.5	6	4.8	19	ø3.4	7	31	28	3.5	8.5	42
25	NM3	M3 x 5	0.63	M3 x 8	0.63	M4 x 10	1.5	5	8.8	19	ø3.4	7	31	28	3.5	5.5	42
	NZ	M3 x 12	1.5	M4 x 12	1.5	M6 x 14	5.2	14	4.5	30	M5 x 0.8	8.5	70	50	4.6	13	60
	NY	M3 x 12	1.5	M4 x 12	1.5	M6 x 14	5.2	11	4.5	30	M4 x 0.7	7	70	50	4.6	13	60
	NW	M4 x 12	3.6	M4 x 12	1.5	M6 x 14	5.2	9	4.5	30	M5 x 0.8	8.5	70	50	4.6	13	60
	NU	M3 x 12	1.5	M4 x 12	1.5	M6 x 14	5.2	11	4.5	30	M5 x 0.8	8.5	70	50	4.6	13	60
	NT	M3 x 12	1.5	M4 x 12	1.5	M6 x 14	5.2	12	8.5	30	M5 x 0.8	8.5	70	50	4.6	17	60
25	NM1	M3 x 5	0.63	M4 x 12	1.5	M6 x 14	5.2	6.35	8	30	M4 x 0.7	(5)	47.1	38.2	—	5	56.4
	NM2	M3 x 12	1.5	M4 x 12	1.5	M6 x 14	5.2	10	3	30	M4 x 0.7	8	50	38.2	—	11.5	60

Motor Mounting Diagram

Mounting procedure

- 1) Secure the motor pulley to the motor (provided by the customer) with the MM1 hexagon socket head cap screw or hexagon socket head set screw.
- 2) Secure the motor to the motor flange with the motor mounting screws (provided by the customer).
- 3) Put the timing belt on the motor pulley and body side pulley, and then secure it temporarily with the MM2 hexagon socket head cap screws. (Refer to the mounting diagram.)
- 4) Apply the belt tension and tighten the timing belt with the MM2 hexagon socket head cap screws. (The reference level is the elimination of the belt deflection.)
- 5) Secure the return plate with the MM3 hexagon socket head cap screws.

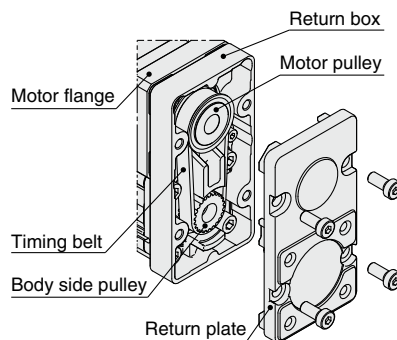

Included Parts List

Size: 16, 25

Description	Quantity	
	Motor type	
	NZ/NY/NW/NT/NM2	NM1/NM3
Motor flange	1	1
Motor pulley	1	1
Return plate	1	1
Timing belt	1	1
Hexagon socket head cap screw (to mount the return plate)	4	4
Hexagon socket head cap screw (to mount the motor flange)	2	2
Hexagon socket head cap screw (to secure the pulley)	1	—
Hexagon socket head set screw (to secure the pulley)	—	1

LESYH Series

Motorless Type

- The motor and motor mounting screws should be provided by the customer.
- Motor shaft type should be cylindrical for the NZ, NY, NX, NW, NM2 motor types, and D-cut type for the NM1 motor type.
- When mounting a hub, remove all oil content, dust, and dirt adhered to the shaft and the inside of the hub.
- Take measures to prevent the loosening of the motor mounting screws and hexagon socket head set screws.

Motor Mounting: In-line

LESYH₁₆^{16D}_{25D}

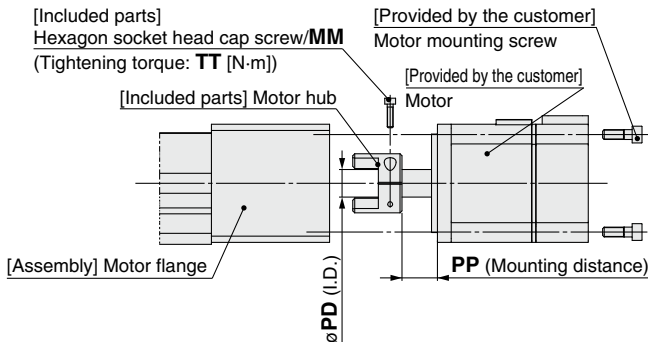

Mounting procedure

- 1) Secure the motor hub to the motor (provided by the customer) with the MM hexagon socket head cap screw.
- 2) Check the motor hub position, and then insert it. (Refer to the mounting diagram.)
- 3) Secure the motor to the motor flange with the motor mounting screws (provided by the customer).

LESYH16D: NM1

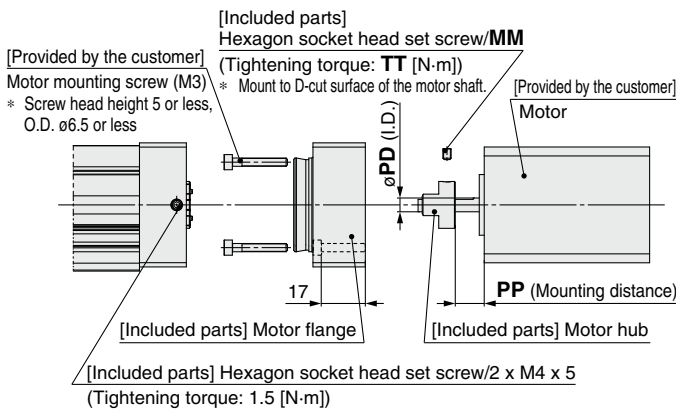

Mounting procedure

- 1) Secure the motor hub to the motor (provided by the customer) with the M3 x 4 hexagon socket head set screw.
- 2) Secure the motor to the motor flange with the motor mounting screws (provided by the customer).
- 3) Check the motor hub position, and then insert it. (Refer to the mounting diagram.)
- 4) Secure the motor flange with the M4 x 5 hexagon socket head set screws.

LESYH25D: NM1

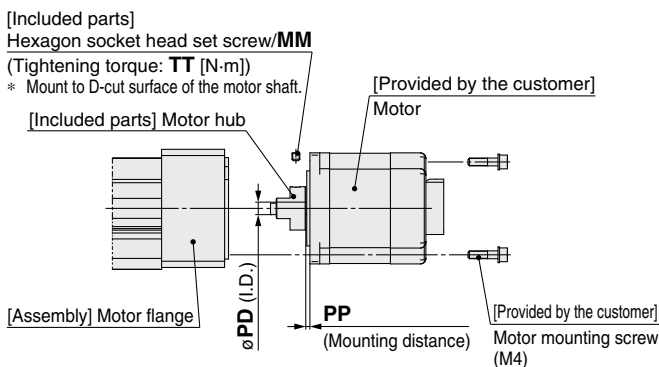

Mounting procedure

- 1) Secure the motor hub to the motor (provided by the customer) with the MM hexagon socket head set screw.
- 2) Check the motor hub position, and then insert it. (Refer to the mounting diagram.)
- 3) Secure the motor to the motor block with the motor mounting screws (provided by the customer).

LESYH16D: NM2

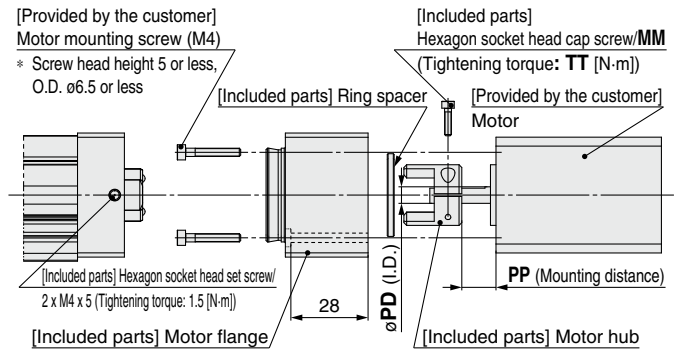

Mounting procedure

- 1) Insert the ring spacer into the motor (provided by the customer).
- 2) Secure the motor hub to the motor (provided by the customer) with the M2.5 x 10 hexagon socket head cap screw.
- 3) Secure the motor to the motor flange with the motor mounting screws (provided by the customer).
- 4) Check the motor hub position, and then insert it. (Refer to the mounting diagram.)
- 5) Secure the motor flange with the M4 x 5 hexagon socket head set screws.

Motor Mounting Diagram

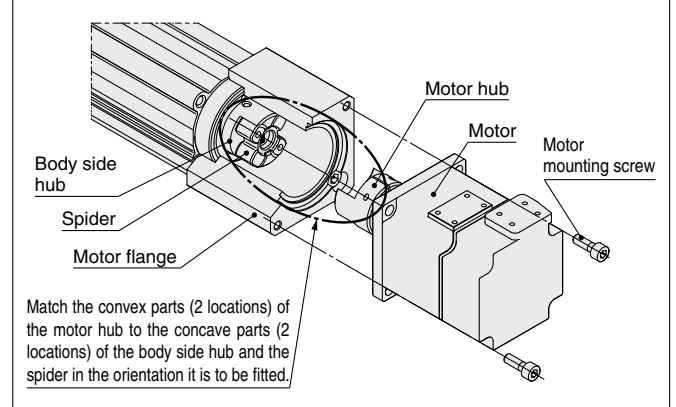

Dimensions

		[mm]				
Size	Motor type	MM	TT	PD	PP	
16	NZ	M2.5 x 10	1.0	8	12.5	
	NY	M2.5 x 10	1.0	8	12.5	
	NX	M2.5 x 10	1.0	8	7	
	NM1	M3 x 5	0.63	5	10.5	
25	NM2	M2.5 x 10	1.0	6	12.4	
	NZ	M3 x 12	1.5	14	18	
	NY	M4 x 12	3.6	11	18	
	NX	M4 x 12	3.6	9	5	
	NW	M4 x 12	3.6	9	12	
	NV	M4 x 12	3.6	9	5	
	NU	M4 x 12	3.6	11	12	
	NT	M3 x 12	1.5	12	18	
	NM1	M4 x 5	1.5	6.35	2.1	
	NM2	M4 x 12	3.6	10	12	

Included Parts List

Size: 16

Description	Quantity		
	Motor type		
	NZ/NY/NX	NM1	NM2
Motor hub	1	1	1
Hexagon socket head cap screw (to secure the hub)	1	—	1
Motor flange	—	1	1
Hexagon socket head set screw (to secure the hub)	—	1	—
Hexagon socket head set screw (to secure the motor flange)	—	2	2
Ring spacer	—	—	1

Size: 25

Description	Quantity	
	Motor type	
	NZ/NY/NX/NW/NV/NU/NT/NM2	NM1
Motor hub	1	1
Hexagon socket head cap screw (to secure the hub)	1	—
Hexagon socket head set screw (to secure the hub)	—	1

LESYH Series Motor Mounting Parts

Motor Flange Option

A motor can be added to the motorless specification after purchase. The applicable motor types are shown below. (Excludes options “NM1” and “NM3”)

Use the following part numbers to select a compatible motor flange option and place an order.

How to Order

LEY-MF **25** **P** - **NZ**

①

②

③

① Size

25	For the LESYH16
32	For the LESYH25

* Please note that the size in the model number is different from the actuator size.

② Motor mounting position

P	Parallel
D	In-line

③ Motor type

Symbol	Type	Symbol	Type
NZ	Mounting type Z	NV	Mounting type V
NY	Mounting type Y	NU	Mounting type U
NX	Mounting type X	NT	Mounting type T
NW	Mounting type W	NM2	Mounting type M2

* Refer to “Compatible Motors.”

Compatible Motors

Applicable motor model			Actuator/Motor type												
Manufacturer	Series	Type	LESYH16				LESYH25								
			NZ Mounting type Z	NY Mounting type Y	NX Mounting type X	NM2 Mounting type M2	NZ Mounting type Z	NY Mounting type Y	NX Mounting type X	NW Mounting type W	NV Mounting type V	NU Mounting type U	NT Mounting type T	NM2 Mounting type M2	
Mitsubishi Electric Corporation	MELSERVO-JN	HF-KN	●	—	—	—	●	—	—	—	—	—	—	—	—
	MELSERVO-J4	HG-KR	●	—	—	—	●	—	—	—	—	—	—	—	—
	MELSERVO-J5	HK-KT	●	—	—	—	●	—	—	—	—	—	—	—	—
YASKAWA Electric Corporation	Σ-V	SGMJV	●	—	—	—	●	—	—	—	—	—	—	—	—
	Σ-7	SGM7J/SGM7A	●	—	—	—	●	—	—	—	—	—	—	—	—
SANYO DENKI CO., LTD.	SANMOTION R	R2	●	—	—	—	●	—	—	—	—	—	—	—	—
OMRON Corporation	Sysmac G5	R88M-K	●	—	—	—	—	●	—	—	—	—	—	—	—
	1 S	R88M-1	●	—	—	—	—	●	—	—	—	—	—	—	—
Panasonic Corporation	MINAS A5	MSM□/MHMD	—	●	—	—	—	●	—	—	—	—	—	—	—
		MSMF	—	●	—	—	—	●	—	—	—	—	—	—	
	MINAS A6	MHMF	●	—	—	—	—	●	—	—	—	—	—	—	—
FANUC CORPORATION	βis (-B)	β	●	—	—	—	● (β1 only)	—	—	●	—	—	—	—	—
NIDEC SANKYO CORPORATION	S-FLAG	MA/MH/MM	●	—	—	—	●	—	—	—	—	—	—	—	—
KEYENCE CORPORATION	SV	SV-M/SV-B	●	—	—	—	●	—	—	—	—	—	—	—	—
	SV2	SV2-M/SV2-B	●	—	—	—	●	—	—	—	—	—	—	—	—
FUJI ELECTRIC CO., LTD.	ALPHA5	GYS/GYB	●	—	—	—	●	—	—	—	—	—	—	—	—
	ALPHA7	GYS/GYB	●	—	—	—	●	—	—	—	—	—	—	—	—
	FALDIC α	GYS	●	—	—	—	●	—	—	—	—	—	—	—	—
MinebeaMitsumi Inc.	SZ	A17PM/A23KM	—	—	—	—	—	—	—	—	—	—	—	—	—
Shinano Kenshi Co., Ltd.	CSB-BZ	CSB-BZ	—	—	—	—	—	—	—	—	—	—	—	—	—
ORIENTAL MOTOR Co., Ltd.	AR/AZ	AR/AZ (46 only)	—	—	—	●	—	—	—	—	—	—	—	—	—
	AR/AZ	AR/AZ	—	—	—	—	—	—	—	—	—	—	—	—	●
FASTECH Co., Ltd.	Ezi-SERVO	EzM	—	—	—	—	—	—	—	—	—	—	—	—	—
Rockwell Automation, Inc. (Allen-Bradley)	MP-/VP-	MP/VP	—	—	—	—	—	—	—	●*1	—	—	—	—	—
	TL	TLY-A	●	—	—	—	—	—	—	—	—	—	—	●	—
Beckhoff Automation GmbH	AM	AM30	●	—	—	—	—	—	—	—	●*1	—	—	—	—
	AM	AM31	●	—	—	—	—	—	—	—	—	●	—	—	—
	AM	AM80/AM81	●	—	—	—	—	—	—	●*1	—	—	—	—	—
Siemens AG	1FK7	1FK7	—	—	●	—	—	—	●*1	—	—	—	—	—	—
Delta Electronics, Inc.	ASDA-A2	ECMA	●	—	—	—	●	—	—	—	—	—	—	—	—
ANCA Motion	AMD2000	Alpha	●	—	—	—	●	—	—	—	—	—	—	—	—

* When the LESYH₂₅¹⁶□□□□ is purchased, it is not possible to change to other motor types.

*1 Motor mounting position: In-line only

LESYH Series

Dimensions: Motor Flange Option

Motor mounting position: Parallel

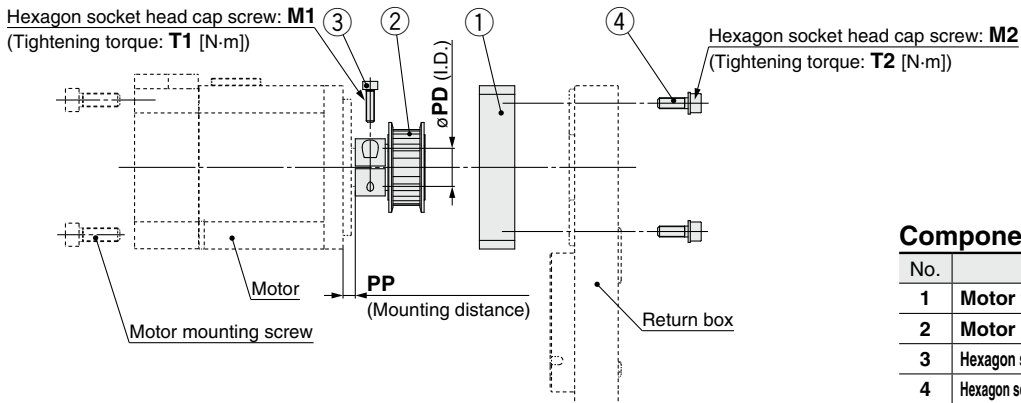

Component Parts

No.	Description	Quantity
1	Motor flange	1
2	Motor pulley	1
3	Hexagon socket head cap screw (to secure the pulley)	1
4	Hexagon socket head cap screw (to mount the motor flange)	2

Motor flange details

Size: 25, 32

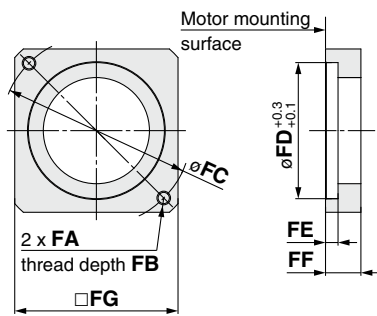

Size 25: NM2

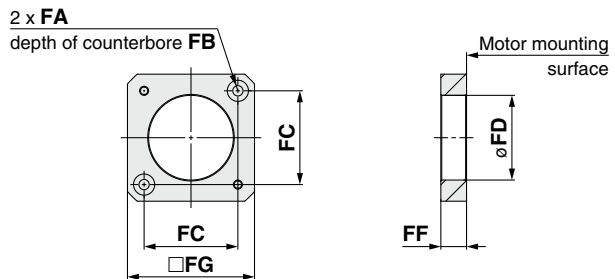

Size 32: NM2

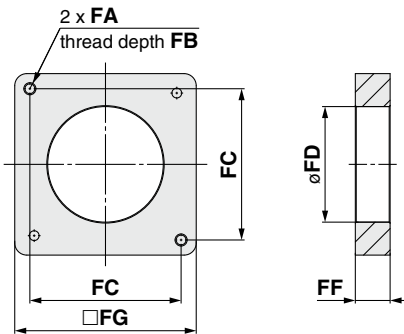

Dimensions

Size	Motor type	FA	FB	FC	FD	FE	FF	FG	M1	T1	M2	T2	PD	PP
25 (LESYH16)	NZ	M4 x 0.7	7.5	46	30	3.7	11	42	M2.5 x 10	1.0	M3 x 8	0.63	8	7.5
	NY	M3 x 0.5	5.5	45	30	5	11	42	M2.5 x 10	1.0	M3 x 8	0.63	8	7.5
	NX	M4 x 0.7	7	46	30	3.7	8	42	M2.5 x 10	1.0	M3 x 8	0.63	8	4.5
	NM2	$\phi 3.4$	7	31	30	3.7	8.5	42	M2.5 x 10	1.0	M3 x 8	0.63	6	4.8
32 (LESYH25)	NZ	M5 x 0.8	8.5	70	50	4.6	13	60	M3 x 12	1.5	M4 x 12	1.5	14	4.5
	NY	M4 x 0.7	7	70	50	4.6	13	60	M3 x 12	1.5	M4 x 12	1.5	11	4.5
	NW	M5 x 0.8	8.5	70	50	4.6	13	60	M4 x 12	3.6	M4 x 12	1.5	9	4.5
	NU	M5 x 0.8	8.5	70	50	4.6	13	60	M3 x 12	1.5	M4 x 12	1.5	11	4.5
	NT	M5 x 0.8	8.5	70	50	4.6	17	60	M3 x 12	1.5	M4 x 12	1.5	12	8.5
	NM2	M4 x 0.7	8	50	38.2	—	11.5	60	M3 x 12	1.5	M4 x 12	1.5	10	3

Electric Actuator Slide Table/High Precision Type



⚠ Safety Instructions Be sure to read the “Handling Precautions for SMC Products” (M-E03-3) and “Operation Manual” before use.