



# Speed Controller

with Indicator

RoHS

## In-line Type

The numerical indication of flow rate knob rotations

reduces flow setting time and setting errors!

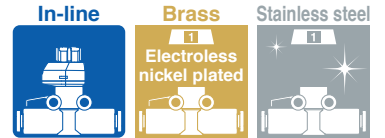

**"Made to Order" section has been added.** Pages 3, 8

- Lubricant: Vaseline -X12
- Grease-free + Restrictor -X21
- Restrictor -X214
- Clean Series 10-



Flow rate can be controlled numerically with the **indicator window.**



Body size 1		Body size 2 or larger	
Indicator window	Number of needle rotations	Indicator window	Number of needle rotations
1	1	1	1
2	2	2	2
⋮	⋮	⋮	⋮
8	8	10	10

## 4 indicator window directions available

Indicator window direction: 0°

Indicator window direction: 90°

Indicator window direction: 180°

Indicator window direction: 270°

Wide viewing angle

Index plate

CyL.A Lift side

## Larger Push-lock type knob

Easy to lock

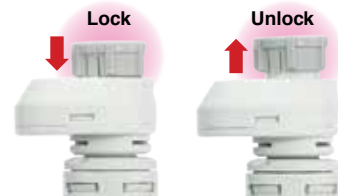

The larger knob and marking of every 90° mark allows for easier operation.

Body size	øD [mm]
1	9.4
2	12 (Port size 1/8) 13 (Port size 1/4)
3	16.6
4	18.8

## AS Series

## Flow Rate Reproducibility



### Improved reproducibility of flow rate

Stable knob position when fully closed (no flow rate) onto the contact face stopper (rotating stopper).  
Minimal flow rate variations between knob rotations

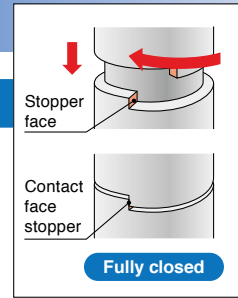

## Mounting Variations

### Direct mounting

If the mounting surface does not interfere with the bonnet:

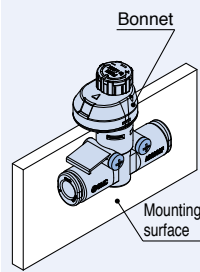

If the mounting surface interferes with the bonnet:  
**Adapter needed** [Page 7](#)

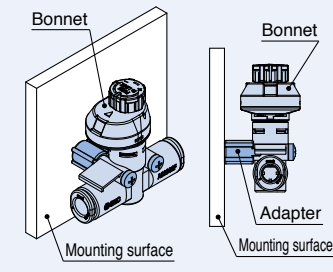

### Holder mounting

[Page 10](#)

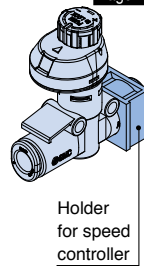

### DIN rail mounting

[Page 7](#)

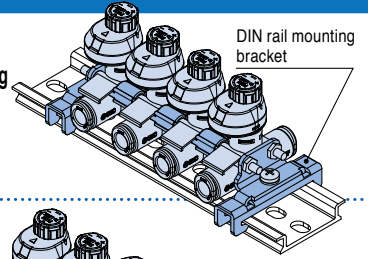

[Page 7](#)

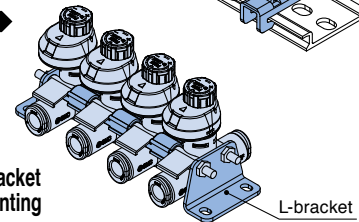

### L-bracket mounting



## Easy Identification of Product Type

### By index plate

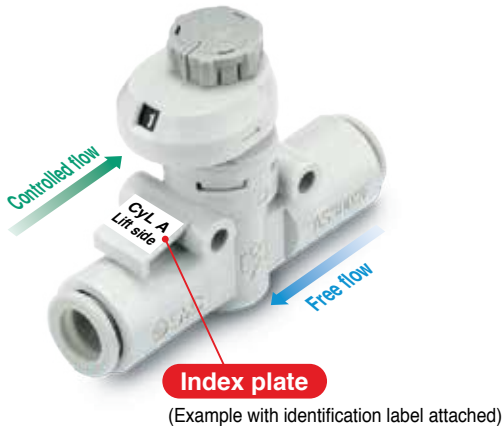
It is possible to identify the product when multiple controllers are mounted and identify the flow direction by attaching an identification label.







### By color

Model	Release button color	
	Metric	Inch
 AS-FS <a href="#">Page 3</a>	Light gray	Orange
 AS-FSG <a href="#">Page 8</a>	White	White



### Series Variations

⊙ The electroless nickel plating type is standardized. ⊙ The stainless steel type is standardized.

Model	Applicable tubing O.D.											Metal parts material	Applicable tubing material	
	Metric size						Inch size							
	3.2	4	6	8	10	12	1/8"	5/32"	1/4"	5/16"	3/8"			1/2"
 AS1002FS□	●	●	●				●	●	●				· Brass · Stainless steel	Nylon (T, TIA series) Soft nylon (TS, TISA series) Polyurethane (T, TIUB series) Fluoropolymer (TLM, TILM series) (TH, TIH series)
 AS2002FS□		●	●					●	●					
 AS2052FS□			●	●					●	●				
 AS3002FS□			●	●	●	●			●	●	●	●		
 AS4002FS□					●	●					●	●		

Made to Order (Pages 3, 8)

**Restrictor**

• Flow control of air blow and air purge

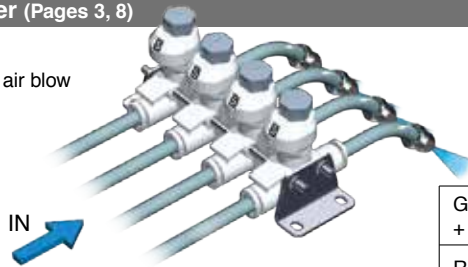

Grease-free (Seal: Fluorine-coated) + Restrictor (Without check valve)	<b>-X21</b>
Restrictor (Without check valve)	<b>-X214</b>

### Push-Lock Series Variations

**Speed Controller with One-touch Fitting AS Series**

Body size	Port size	Applicable tubing O.D.	
		Metric size	Inch size
1 to 4	M5 to 1/2	ø2 to ø16	ø1/8" to ø1/2"



Refer to the Web Catalog for details.

**Speed Controller with One-touch Fittings In-line Type AS Series**

Body size	Port size	Applicable tubing O.D.	
		Metric size	Inch size
1 to 4	M5 to 1/2	ø3.2 to ø12	ø1/8" to ø1/2"



Refer to the Web Catalog for details.

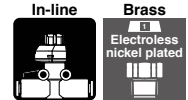

## Model

Model	Applicable tubing O.D.												
	Metric size						Inch size						
	3.2	4	6	8	10	12	1/8"	5/32"	1/4"	5/16"	3/8"	1/2"	
AS1002FS□	●	●	●				●	●	●				
AS2002FS□		●	●					●	●				
AS2052FS□			●	●					●	●			
AS3002FS□			●	●	●	●			●	●	●		
AS4002FS□					●	●					●	●	

## Specifications

Fluid	Air
Proof pressure	1.5 MPa
Max. operating pressure	1 MPa
Min. operating pressure	0.1 MPa
Ambient and fluid temperatures	-5 to 60°C (No freezing)
Applicable tubing material	Nylon, Soft nylon, Polyurethane*1, FEP, PFA

\*1 Use caution at the max. operating pressure when using soft nylon or polyurethane tubing. (Refer to the **Web Catalog** for details.)

## Flow Rate and Sonic Conductance

Model	AS1002FS□	AS2002FS□	AS2052FS□	AS3002FS□	AS4002FS□									
Tubing O.D.	Metric size	ø3.2	ø4	ø6	ø4	ø6	ø6	ø8	ø6	ø8	ø10	ø12	ø10	ø12
	Inch size	ø1/8"	ø5/32"	ø1/4"	ø5/32"	ø1/4"	ø1/4"	ø5/16"	ø1/4"	ø5/16"	ø3/8"	—	ø3/8"	ø1/2"
C values: Sonic conductance dm <sup>3</sup> /(s·bar)	Free flow	0.3	0.4	0.6	0.4	0.6	1.0	1.2	1.1	1.6	2.2	2.6	2.4	3.5
	Controlled flow	0.3			0.4	0.6	1.0	1.2	1.3	1.9	2.7	3.3	2.8	4.1
b values: Critical pressure ratio	Free flow	0.3	0.2		0.3	0.1	0.2		0.2			0.3	0.2	
	Controlled flow	0.2	0.3	0.4	0.2		0.2	0.3	0.1	0.2		0.1	0.2	

Flow Direction Symbol on Body

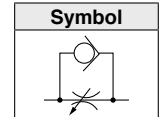

\* C and b values are for controlled flow with the needle fully open and free flow with the needle fully closed.  
 \* The same specifications also apply to the AS-FSG series (stainless steel type).

## How to Order

**AS 200 2 F S 1 - 06 -**

- Body size**

100	M5 standard
200	1/8 standard
205	1/4 standard
300	3/8 standard
400	1/2 standard
- Made to Order**
- Applicable tubing O.D.\*1**

Metric size	Inch size
23	ø3.2*2
04	ø4
06	ø6
08	ø8
10	ø10
12	ø12
01	ø1/8"
03	ø5/32"
07	ø1/4"
09	ø5/16"
11	ø3/8"
13	ø1/2"
- With One-touch fittings**
- With indicator**

### Indicator window direction

Indicator window direction	Indicator window	Index plate	Indicator window	Index plate	
Nil	0°		2	90°	
1	180°		3	270°	

\*1 For selecting applicable tubing O.D., refer to the "Model" shown above.

\*2 Use ø1/8" tubing.

## Made to Order



Lubricant: Vaseline **-X12**

Example) AS2002FS-04-X12

Grease-free (Seal: Fluorine-coated) + Restrictor (Without check valve) **-X21**

Example) AS2002FS-04-X21

\* Not particle-free

Restrictor (Without check valve) **-X214**

Example) AS2002FS-04-X214

Clean Series **10-**

Example) 10-AS2002FS-04

\*1 Fluorine grease is used.

\*2 The cleanliness class (ISO class) is 5.

## Caution

Be sure to read this before handling the products. Refer to the back cover for safety instructions. For flow control equipment precautions, refer to the "Handling Precautions for SMC Products" and the "Operation Manual" on the SMC website.

## Options

### ① Adapter for Direct Mounting

\* For use when the mounting surface interferes with the bonnet.

Part no.	Applicable model
<b>AS-10A1</b>	AS1002FS□
<b>AS-20A1</b>	AS2002FS□
<b>AS-25A1</b>	AS2052FS□
<b>AS-30A1</b>	AS3002FS□

\* The AS4002FS□ can be mounted without the adapter.

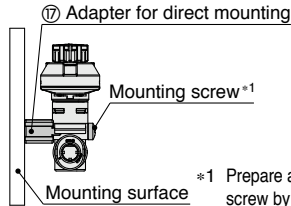

\*1 Prepare a mounting screw by user.

### ② DIN Rail Mounting Bracket

Part no.	Applicable model
<b>AS-10D</b>	AS1002FS□
<b>AS-20D</b>	AS2002FS□
<b>AS-25D</b>	AS2052FS□
<b>AS-30D</b>	AS3002FS□
<b>AS-40D</b>	AS4002FS□

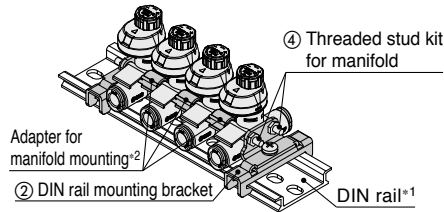

\*1 Prepare DIN rail by user.

\*2 It is included in the threaded stud kit for manifold (excluding the AS4002FS□). Refer to the following details of the kit.

### ③ L-Bracket

Part no.	Applicable model
<b>AS-10L</b>	AS1002FS□
<b>AS-20L</b>	AS2002FS□
<b>AS-25L</b>	AS2052FS□
<b>AS-30L</b>	AS3002FS□
<b>AS-40L</b>	AS4002FS□

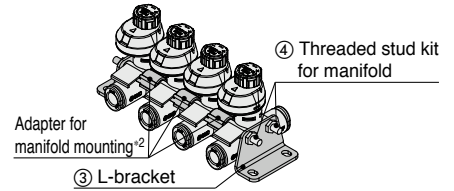

### ④ Threaded Stud Kit for Manifold

Part number				Applicable model	
4 stations	6 stations	8 stations	10 stations	Metric size	Inch size
<b>AS-1AB</b>	<b>AS-3AB</b>	<b>AS-5AB</b>	<b>AS-7AB</b>	AS1002FS□-23	AS1002FS□-01
				AS1002FS□-04	AS1002FS□-03
<b>AS-2AB</b>	<b>AS-4AB</b>	<b>AS-6AB</b>	<b>AS-8AB</b> <b>AS-23AB</b>	AS1002FS□-06	—
				—	AS1002FS□-07
<b>AS-9AB</b>	<b>AS-10AB</b>	<b>AS-11AB</b>	<b>AS-12AB</b>	AS2002FS□-04	AS2002FS□-03
				AS2002FS□-06	—
<b>AS-13AB</b>	<b>AS-14AB</b>	<b>AS-15AB</b>	<b>AS-16AB</b>	—	AS2002FS□-07
				AS2052FS□-06	—
<b>AS-17AB</b>	<b>AS-19AB</b>	<b>AS-20AB</b>	<b>AS-22AB</b>	—	AS2052FS□-07
				AS2052FS□-08	AS2052FS□-09
				AS3002FS□-06	—
				—	AS3002FS□-07
<b>AS-24AB</b>	<b>AS-25AB</b>	<b>AS-25AB</b>	<b>AS-25AB</b>	AS3002FS□-08	AS3002FS□-09
				AS3002FS□-10	—
				—	AS3002FS□-11
<b>AS-43B</b>	<b>AS-45B</b>	<b>AS-47B</b>	<b>AS-48B</b>	AS3002FS□-12	—
				AS4002FS□-10	—
				—	AS4002FS□-11
				AS4002FS□-12	—
—	—	—	—	AS4002FS□-13	—

### Details of Threaded Stud Kit for Manifold

Part no.	Adapter for manifold mounting		Threaded stud		Accessories			
	Part no.	Quantity	Length	Quantity	Hexagon nut	Quantity	Flat washer	Quantity
<b>AS-1AB</b>	AS-10A	3	72	2	M3	4	M3	4
<b>AS-2AB</b>			90	2				
<b>AS-3AB</b>		5	104	2				
<b>AS-4AB</b>			114	2				
<b>AS-5AB</b>		7	135	2				
<b>AS-6AB</b>			143	2				
<b>AS-7AB</b>		9	167	2				
<b>AS-8AB</b>			170	2				
<b>AS-23AB</b>		180	2					
<b>AS-9AB</b>		AS-20A	3	90				
<b>AS-10AB</b>	5		135	2				
<b>AS-11AB</b>	7		180	2				
<b>AS-12AB</b>	9	220	2					
<b>AS-13AB</b>	AS-25A	3	111	2				
<b>AS-14AB</b>		5	147	2				
<b>AS-15AB</b>		7	191	2				
<b>AS-16AB</b>		9	236	2				
<b>AS-17AB</b>		3	111	2				
<b>AS-24AB</b>	AS-30A	3	119	2				
<b>AS-19AB</b>		5	179	2				
<b>AS-20AB</b>		7	236	2				
<b>AS-21AB</b>		9	258	2				
<b>AS-22AB</b>		9	277	2				
<b>AS-25AB</b>		9	293	2				
<b>AS-43B</b>	—	—	119	2				
<b>AS-45B</b>		—	179	2				
<b>AS-47B</b>		—	236	2				
<b>AS-48B</b>		—	277	2				

\* AS4002FS□ type can be mounted with the threaded stud kit only (Adapter for manifold mounting is not required).

### Ordering Example

Threaded studs for manifold are not included when L-bracket and DIN rail mounting bracket are ordered. Please order them according to the number of stations.

#### Ex.) AS2002FS-06

When connecting 4 pcs. and mounting L-brackets on both sides

- Speed controller **AS2002FS-06** ... 4 pcs.
- L-bracket **AS-20L** ..... 2 pcs.
- Threaded stud kit for manifold **AS-9AB** ..... 1 set (Adapter for manifold mounting is included.)

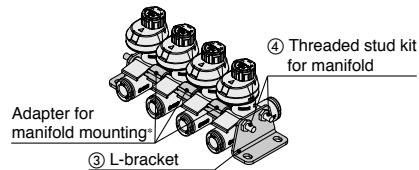

\* It is included in the threaded stud kit for manifold (excluding the AS4002FS□). Refer to the details of the kit shown on the left.

## Needle Valve: Flow Rate Characteristics

\* The flow rate characteristics are representative values.

### AS1002FS□

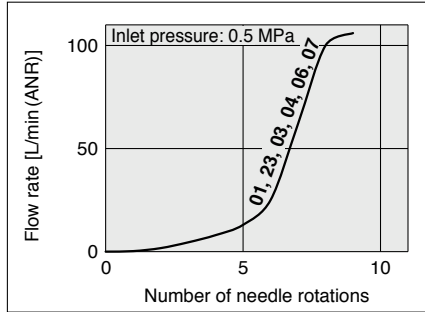

### AS2002FS□

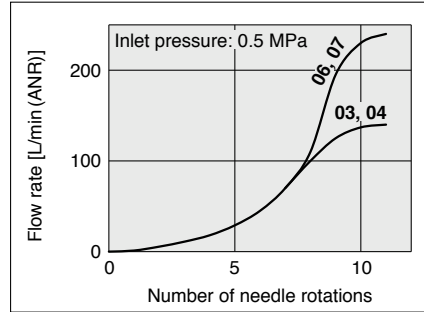

### AS2052FS□

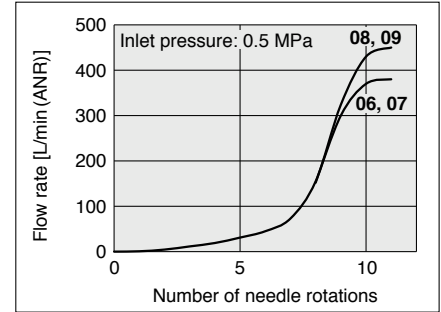

### AS3002FS□

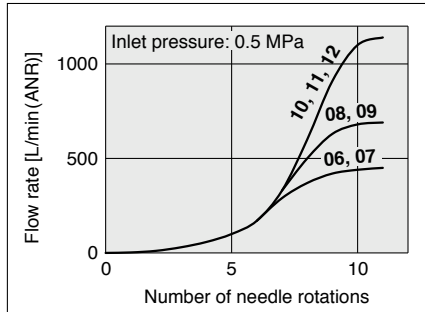

### AS4002FS□

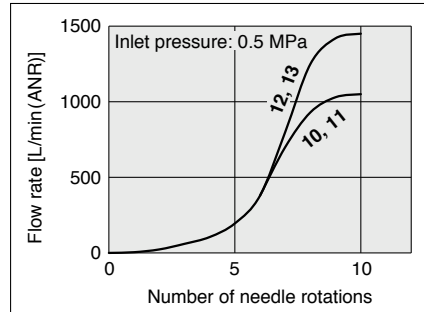

1 MPa = 145.038 psi  
1 L/min = 0.04 scfm

\* The numbers above the flow rate characteristic curves in the charts show the applicable tubing outside diameter as defined by the product number.

## Construction

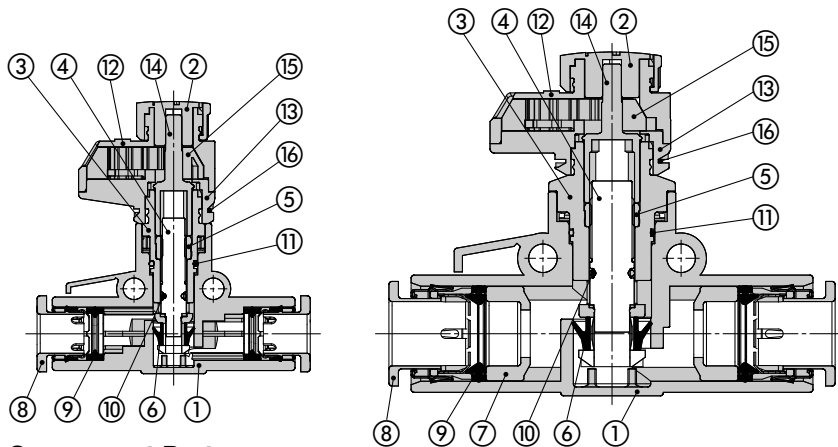

### Component Parts

No.	Description	Material	Note
1	Body A	PBT	
2	Knob	POM	
3	Body B	PBT	
4	Needle	PBT	
5	Needle guide	Brass	Electroless nickel plating
6	U-seal	HNBR	
7	Spacer	PBT*1	
8	Cassette	—	
9	Seal	NBR	
10	O-ring	NBR	
11	O-ring	NBR	
12	Bonnet A	POM	
13	Bonnet B	POM	
14	Gear	PPS	
15	Indicator gear	POM	
16	Clip	Stainless steel	

\*1 The AS3002FS□-11, AS4002FS□-11, AS4002FS□-13 are made of electroless nickel plated brass.

### L-Bracket

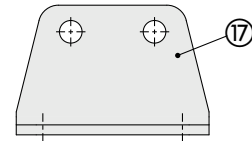

### Component Parts

No.	Description	Material
1	Bracket	Steel strip

### DIN Rail Mounting Bracket

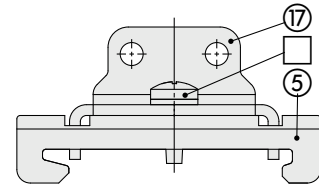

### Component Parts

No.	Description	Material
1	Bracket	Steel strip
2	Cross recessed round head screw	Steel wire
3	Clasp	Steel strip

## Dimensions

Indicator window direction: 0°

Indicator window direction: 180°

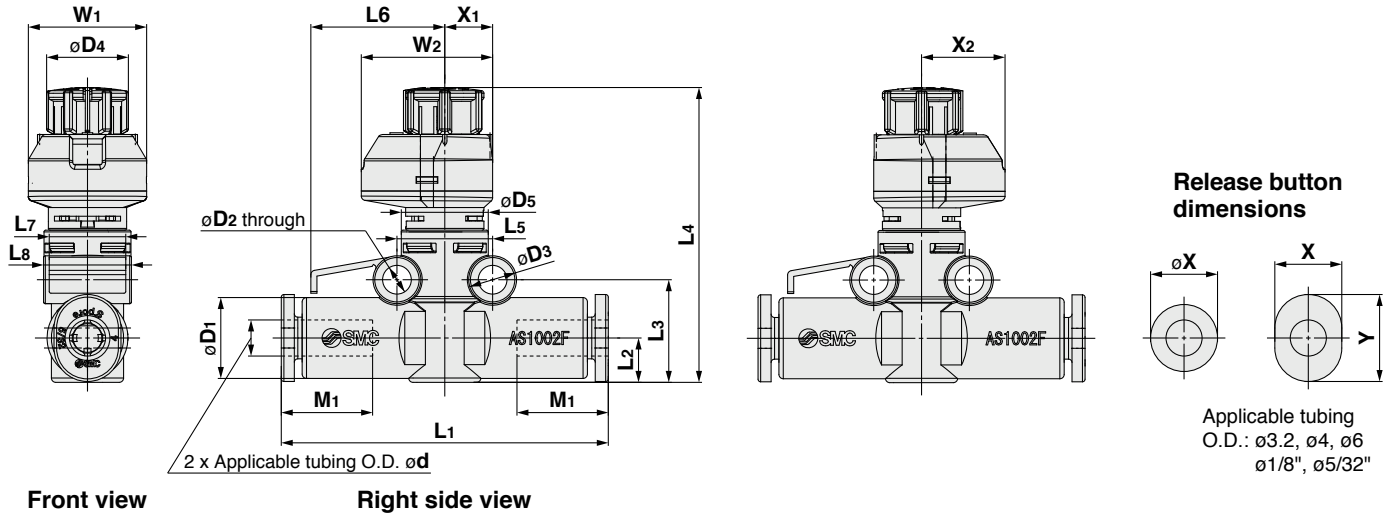

### Metric Size

Model	Applicable tubing O.D. ød	D1	Release button		D2	D3	D4	D5	L1	L2	L3	L4*1		L5	L6	L7	L8	M1	W1	W2	X1	X2	Weight [g]				
			øX(X)	Y								Max.	Min.														
AS1002FS□-23	3.2	8.4	6.7	9.5	3.3	5.5	9.4	10	36.6	5.1	11.8	36.4	33.9	11	15.4	8.8	10.1	13.5	13.6	15.1	5.5	9.6	5.2				
AS1002FS□-04	4	9.3	7.7	10					37.6								12.8						37.4	34.9	12.3	5.5	5.5
AS1002FS□-06	6	11.6	9.7	12					40.1								6.1						37.4	34.9	12.3	6.6	6.6
AS2002FS□-04	4	9.3	7.7	10	3.3	5.5	12	12	41.3	6.3	13.4	44.5	43	12.6	17	10.5	12.3	13.5	20	21.5	6.5	15	9.5				
AS2002FS□-06	6	11.6	9.7	12					43.1								44.5						43	12.3	10.4	10.4	
AS2052FS□-06	6	12.8	11.5	—					54.2								7.6						17.2	49	47.6	17	22.5
AS2052FS□-08	8	15.2	13.5	—	4.3	7.8	13	16	57.2	8.5	18.1	49.9	48.5	17	22.5	12	16.1	19	21.5	24	7.8	16.2	18.4				
AS3002FS□-06	6	13.2	11.5	—	4.5	8	16.6	20	60	9.8	21.7	55.7	54.3	21.8	25	12	17	24.5	28.5	9.3	19.2	23.8					
AS3002FS□-08	8	15.2	13.5	—					65								54.3					21.8	25	12	19	26	
AS3002FS□-10	10	18.5	16.5	—					70.4								54.3					21.8	25	12	21	30.6	
AS3002FS□-12	12	20.9	18.5	—	76	54.3	21.8	25	12	22	34.2																
AS4002FS□-10	10	18.5	16.5	—	4.3	8	18.8	26	76.9	11.3	23.7	64.3	62.7	28	33	14	21	26	29	10	19	42.5					
AS4002FS□-12	12	21.7	18.5	—					81.3								62.7					28	33	14	22	47.9	

\*1 Reference dimensions

### Inch Size

Model	Applicable tubing O.D. ød	D1	Release button		D2	D3	D4	D5	L1	L2	L3	L4*1		L5	L6	L7	L8	M1	W1	W2	X1	X2	Weight [g]				
			øX(X)	Y								Max.	Min.														
AS1002FS□-01	1/8"	8.4	6.7	9.5	3.3	5.5	9.4	10	36.6	5.1	11.8	36.4	33.9	11	15.4	8.8	10.1	13.5	13.6	15.1	5.5	9.6	5.2				
AS1002FS□-03	5/32"	9.3	7.7	10					37.6								12.9						37.5	35	12.8	5.5	5.5
AS1002FS□-07	1/4"	12	10.9	—					40.1								6.2						37.5	35	12.8	6.7	6.7
AS2002FS□-03	5/32"	9.3	7.7	10	3.3	5.5	12	12	41.3	6.3	13.4	44.5	43	12.6	17	10.5	12.3	13.5	20	21.5	6.5	15	9.5				
AS2002FS□-07	1/4"	12	10.9	—					43.2								6.5						44.7	43.2	12.8	10.6	10.6
AS2052FS□-07	1/4"	13.2	12	—					53.4								7.6						17.2	49	47.6	17	22.5
AS2052FS□-09	5/16"	15.2	13.5	—	4.3	7.8	13	16	57.2	8.5	18.1	49.9	48.5	17	22.5	12	16.1	19	21.5	24	7.8	16.2	18.4				
AS3002FS□-07	1/4"	13.2	12	—	4.5	8	16.6	20	59	9.8	21.7	55.7	54.3	21.8	25	12	17	24.5	28.5	9.3	19.2	23.6					
AS3002FS□-09	5/16"	15.2	13.5	—					65								54.3					21.8	25	12	19	26	
AS3002FS□-11	3/8"	18.5	16	—					69.8								54.3					21.8	25	12	21	38.1	
AS4002FS□-11	3/8"	18.5	16	—	4.3	8	18.8	26	76.9	11.3	23.7	64.3	62.7	28	33	14	21	26	29	10	19	50.2					
AS4002FS□-13	1/2"	21.7	20	—					81.3								62.7					28	33	14	22	57.4	

\*1 Reference dimensions

## Dimensions

### L-Bracket Bracket on a single side

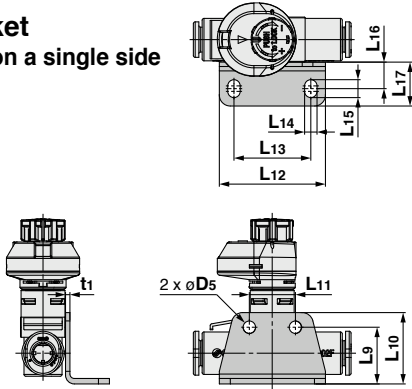

### DIN Rail Mounting Bracket Bracket on a single side

AS1002FS□  
AS2002FS□

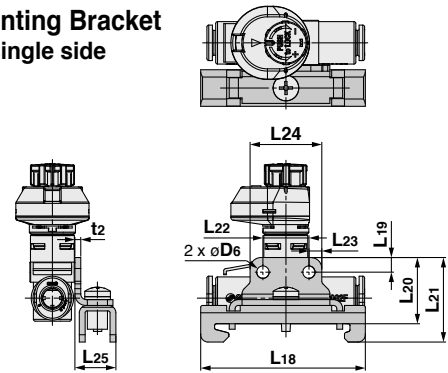

AS2052FS□  
AS3002FS□  
AS4002FS□

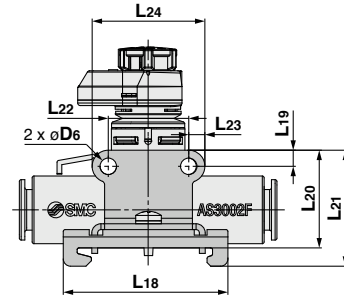

Part no.	Applicable model	D5	L9	L10	L11	L12	L13	L14	L15	L16	L17	t1
AS-10L	AS1002FS□	3.4	14.8	18.3	11	27.5	19.5	3.4	4.9	7.3	12	1
AS-20L	AS2002FS□		15.6	19.6	12.6	29	21					
AS-25L	AS2052FS□		19.6	24.6	17	38	28					
AS-30L	AS3002FS□	4.5	24.8	29.8	22	43	33	4.5	6.5	9.5	15.5	1.4
AS-40L	AS4002FS□		25.7	30.7	28	49	39					

Part no.	Applicable model	D6	L18	L19	L20	L21	L22	L23	L24	L25	t2
AS-10D	AS1002FS□	3.4	45	3.5	18.2	23.2	11	3.5	18		
AS-20D	AS2002FS□				18.6	23.6	12.6				
AS-25D	AS2052FS□				22	27	17				
AS-30D	AS3002FS□	4.5	45	4.4	27.2	32.2	22	4.4	30.8	11.3	1.6
AS-40D	AS4002FS□				28.1	33.1	28				

### Adapter for Manifold Mounting

Part no.: AS-□□A

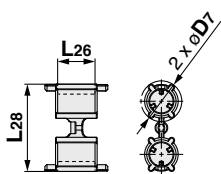

Part no.	Applicable model	D7	L26	L28
AS-10A	AS1002FS□	9.2	4	18.7
AS-20A	AS2002FS□	9.4	8.8	20.4
AS-25A	AS2052FS□	11.4	6.3	27
AS-30A	AS3002FS□	11.8	5.9	32.1

\* The AS4002FS□ can be mounted without the adapter.

### Adapter for Direct Mounting

Part no.: AS-□□A1

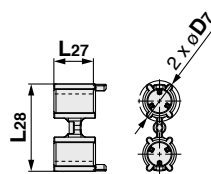

Part no.	Applicable model	D7	L27	L28
AS-10A1	AS1002FS□	9.2	4.5	18.7
AS-20A1	AS2002FS□	9.4	9.3	20.4
AS-25A1	AS2052FS□	11.4	7.1	27
AS-30A1	AS3002FS□	11.8	6.4	32.1

\* The AS4002FS□ can be mounted without the adapter.

### L-Bracket

#### Brackets on both sides

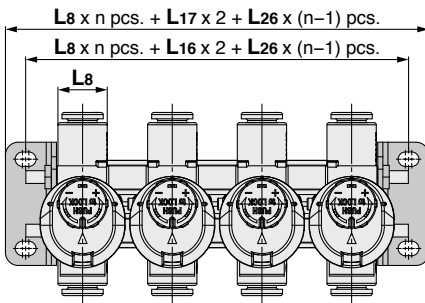

- \* Refer to page 6 for L8.
- \* The figure above shows the manifold with speed controllers connected using two L-brackets, adapters and a threaded stud kit for manifold. Refer to page 4 for threaded stud kits for manifold.
- \* Cannot connect the speed controller when the indicator window direction is 90° or 270°.

### DIN Rail Mounting Bracket

#### Brackets on both sides

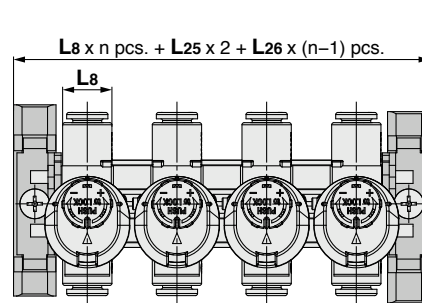

- \* Refer to page 6 for L8.
- \* The figure above shows the manifold with speed controllers connected using two DIN rail mounting brackets, adapters and a threaded stud kit for manifold. Refer to page 4 for threaded stud kits for manifold.
- \* Cannot connect the speed controller when the indicator window direction is 90° or 270°.

### Adapter

#### Direct mounting

\* For use when the mounting surface interferes with the bonnet.

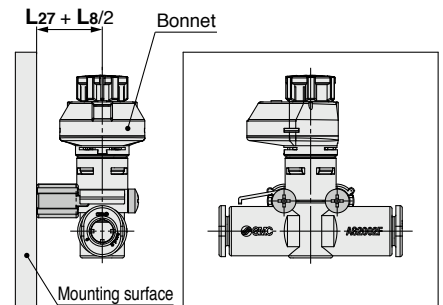

- \* Refer to page 6 for L8.
- \* The AS4002FS□ can be mounted directly without the adapter.



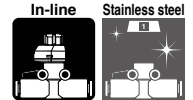

## Model

Model	Applicable tubing O.D.												
	Metric size						Inch size						
	3.2	4	6	8	10	12	1/8"	5/32"	1/4"	5/16"	3/8"	1/2"	
AS1002FSG	●	●	●				●	●	●				
AS2002FSG		●	●					●	●				
AS2052FSG			●	●					●	●			
AS3002FSG			●	●	●				●	●	●		
AS4002FSG					●	●					●	●	

## Specifications

Fluid	Air
<b>Proof pressure</b>	217.557 psi (1.5 MPa)
<b>Max. operating pressure</b>	145.038 psi (1 MPa)
<b>Min. operating pressure</b>	14.5038 psi (0.1 MPa)
<b>Ambient and fluid temperatures</b>	-23 to 140°F (-5 to 60°C) (No freezing)
<b>Applicable tubing material</b>	Nylon, Soft nylon, Polyurethane <sup>*1</sup> , FEP, PFA

<sup>\*1</sup> Use caution at the max. operating pressure when using soft nylon or polyurethane tubing. (Refer to the **Web Catalog** for details.)

## Flow Rate and Sonic Conductance

Model		AS1002FSG□			AS2002FSG□		AS2052FSG□		AS3002FSG□			AS4002FSG□		
Tubing O.D.	Metric size	ø3.2	ø4	ø6	ø4	ø6	ø6	ø8	ø6	ø8	ø10	ø12	ø10	ø12
	Inch size	ø1/8"	ø5/32"	ø1/4"	ø5/32"	ø1/4"	ø1/4"	ø5/16"	ø1/4"	ø5/16"	ø3/8"	—	ø3/8"	ø1/2"
C values: Sonic conductance dm <sup>3</sup> (s·bar)	Free flow	0.3	0.4	0.6	0.4	0.6	1.0	1.2	1.1	1.6	2.2	2.6	2.4	3.5
	Controlled flow	0.3			0.4	0.6	1.0	1.2	1.3	1.9	2.7	3.3	2.8	4.1
b values: Critical pressure ratio	Free flow	0.3	0.2		0.3	0.1	0.2		0.2			0.3	0.2	
	Controlled flow	0.2	0.3	0.4	0.2		0.2	0.3	0.1	0.2		0.1	0.2	

Flow Direction Symbol on Body

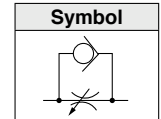

<sup>\*</sup> C and b values are for controlled flow with the needle fully open and free flow with the needle fully closed.

## How to Order

**AS 200 2 F S G 1 - 06 -**   

● **Body size**

100	M5 standard
200	1/8 standard
205	1/4 standard
300	3/8 standard
400	1/2 standard

With indicator

Stainless steel type (Stainless steel 303)

<sup>\*</sup> The material can be visually identified by color of the release button.

Stainless steel type: White

<sup>\*</sup> White is also used for inch size.

● **Made to Order**

● **Applicable tubing O.D.<sup>\*1</sup>**

Metric size		Inch size	
23	ø3.2 <sup>*2</sup>	01	ø1/8"
04	ø4	03	ø5/32"
06	ø6	07	ø1/4"
08	ø8	09	ø5/16"
10	ø10	11	ø3/8"
12	ø12	13	ø1/2"

<sup>\*1</sup> For selecting applicable tubing O.D., refer to the "Model" shown above.

<sup>\*2</sup> Use ø1/8" tubing.

● **Indicator direction**

Indicator direction	Angle	Diagram	Code	Angle	Diagram
Nil	0°		2	90°	
1	180°		3	270°	

## Made to Order



**Lubricant: Vaseline**

**-X12**

Example) AS2002FSG-04-X12

**Grease-free (Seal: Fluorine-coated) + Restrictor (Without check valve)**

**-X21**

Example) AS2002FSG-04-X21

<sup>\*</sup> Not particle-free

**Restrictor (Without check valve)**

**-X214**

Example) AS2002FSG-04-X214

**Clean Series**

**10-**

Example) 10-AS2002FSG-04

<sup>\*1</sup> Fluorine grease is used.

<sup>\*2</sup> The cleanliness class (ISO class) is 5.

Dimensions, flow rate characteristics and options are the same as standard product (brass needle guide). Refer to page 4 for the manifolds (DIN rail bracket mounting/L-bracket mounting).

## Construction

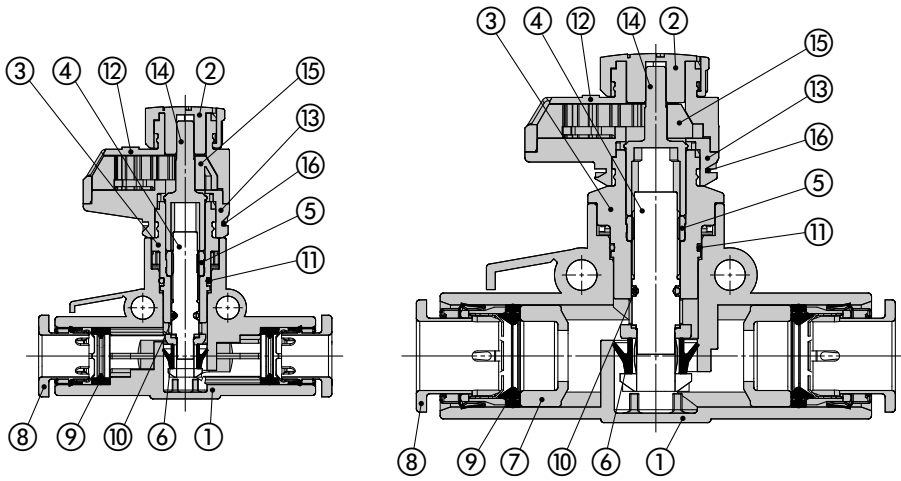

### Component Parts

No.	Description	Material	Note
1	Body A	PBT	
2	Knob	POM	
3	Body B	PBT	
4	Needle	PBT	
5	Needle guide	Stainless steel	
6	U-seal	HNBR	
7	Spacer	PBT*1	
8	Cassette	—	
9	Seal	NBR	
10	O-ring	NBR	
11	O-ring	NBR	
12	Bonnet A	POM	
13	Bonnet B	POM	
14	Gear	PPS	
15	Indicator gear	POM	
16	Clip	Stainless steel	

\*1 The AS3002FS□-11, AS4002FS□-11, AS4002FS□-13 are made of stainless steel.

### L-Bracket

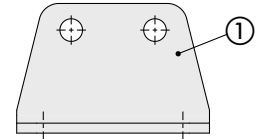

### Component Parts

No.	Description	Material
1	Bracket	Steel strip

### DIN Rail Mounting Bracket

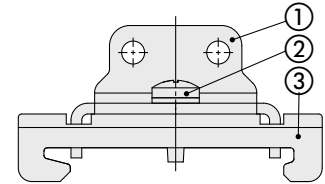

### Component Parts

No.	Description	Material
1	Bracket	Steel strip
2	Cross recessed round head screw	Steel wire
3	Clasp	Steel strip

## A holder for securing a speed controller with One-touch fittings (In-line type)

Possible to hold a single controller



### Holder mounting

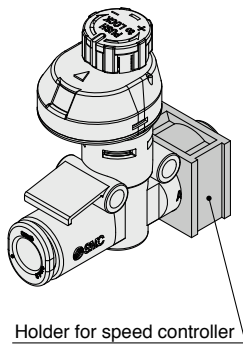

## Specifications

Ambient temperature	-4 to 140°F (-20 to 60°C)
Material	Polypropylene
Color	White

### Accessory: Cross Recessed Round Head Screw for Mounting (Zinc chromated)

Part no.		Size (Nominal x Length)	Quantity
Metric size	Inch size		
<b>TMH-23J</b>	<b>TMH-01J</b>	M3 x 15	1
<b>TMH-04J</b>	<b>TMH-03J</b>		
<b>TMH-06J</b>	<b>TMH-07J</b>	M3 x 20	
<b>TMH-06</b>	<b>TMH-07</b>	M4 x 25	
<b>TMH-08</b>	<b>TMH-09</b>		
<b>TMH-10</b>	—	M4 x 35	
<b>TMH-12</b>	<b>TMH-13</b>		

## Series

Select the applicable holder/TMH for each speed controller from the table below.

### Metric Size

Applicable model	Tubing size	Applicable tubing					
	23 ø3.2	04 ø4	06 ø6	08 ø8	10 ø10	12 ø12	
AS1002FS□	<b>TMH-23J</b>	<b>TMH-04J</b>	<b>TMH-06J</b>				
AS2002FS□							
AS2052FS□			<b>TMH-06</b>	<b>TMH-08</b>			
AS3002FS□			<b>TMH-07</b>				
AS4002FS□					<b>TMH-10</b>	<b>TMH-12</b> <b>TMH-13</b>	

\* The applicable TMH for the AS1002FS□-02 is not available.

### Inch Size

Applicable model	Tubing size	Applicable tubing					
	01 ø1/8"	03 ø5/32"	07 ø1/4"	09 ø5/16"	11 ø3/8"	13 ø1/2"	
AS1002FS□	<b>TMH-01J</b>	<b>TMH-03J</b>	<b>TMH-07J</b>				
AS2002FS□							
AS2052FS□			<b>TMH-07</b>	<b>TMH-09</b>			
AS3002FS□							
AS4002FS□					<b>TMH-10</b>	<b>TMH-13</b>	

## Dimensions

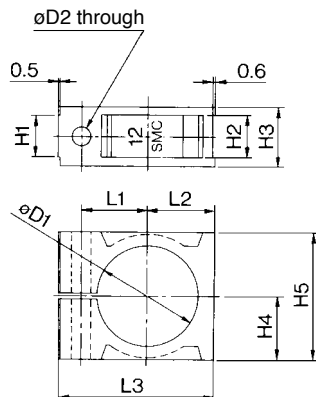

Part no.		øD1	øD2	H1	H2	H3	H4	H5	L1	L2	L3	Symbol
Metric size	Inch size											
<b>TMH-23J</b>	<b>TMH-01J</b>	8.5	3.3	4.5	4.6	7.5	6	12	7.2	6.6	18	1/8J
<b>TMH-04J</b>	<b>TMH-03J</b>	9.4										4 5/32J
<b>TMH-06J</b>	—	11.7	3.3	6.3	6.4	9.3	7.7	15.4	8.5	8.3	21	6J
—	<b>TMH-07J</b>	12.1										1/4J
<b>TMH-06</b>	—	13.1										6
—	<b>TMH-07</b>	13.5	4.3	7.1	7.2	11.1	10	20	11	10.6	26.5	1/4
<b>TMH-08</b>	<b>TMH-09</b>	15.5										8 5/16
<b>TMH-10</b>	—	18.8										10
<b>TMH-12</b>	—	21.2	4.3	9.5	9.6	13.5	14	28	14.2	14.6	34	12
—	<b>TMH-13</b>	22										1/2



These safety instructions are intended to prevent hazardous situations and/or equipment damage. These instructions indicate the level of potential hazard with the labels of “*Cautions*,” “*Warning*” or “*Danger*.” They are all important notes for safety and must be followed in addition to International Standards (ISO/IEC)\*1), and other safety regulations.

- Caution:** Caution indicates a hazard with a low level of risk which, if not avoided, could result in minor or moderate injury.
- Warning:** Warning indicates a hazard with a medium level of risk which, if not avoided, could result in death or serious injury.
- Danger:** Danger indicates a hazard with a high level of risk which, if not avoided, will result in death or serious injury.

\*1) ISO 4414: Pneumatic fluid power – General rules relating to systems.  
 ISO 4413: Hydraulic fluid power – General rules relating to systems.  
 IEC 60204-1: Safety of machinery – Electrical equipment of machines.  
 (Part 1: General requirements)  
 ISO 10218-1: Manipulating industrial robots – Safety.  
 etc.

**Warning**

**1. The compatibility of the product is the responsibility of the person who designs the equipment or decides its specifications.**  
 Since the product specified here is used under various operating conditions, its compatibility with specific equipment must be decided by the person who designs the equipment or decides its specifications based on necessary analysis and test results. The expected performance and safety assurance of the equipment will be the responsibility of the person who has determined its compatibility with the product. This person should also continuously review all specifications of the product referring to its latest catalog information, with a view to giving due consideration to any possibility of equipment failure when configuring the equipment.

**2. Only personnel with appropriate training should operate machinery and equipment.**  
 The product specified here may become unsafe if handled incorrectly. The assembly, operation and maintenance of machines or equipment including our products must be performed by an operator who is appropriately trained and experienced.

**3. Do not service or attempt to remove product and machinery/equipment until safety is confirmed.**

1. The inspection and maintenance of machinery/equipment should only be performed after measures to prevent falling or runaway of the driven objects have been confirmed.
2. When the product is to be removed, confirm that the safety measures as mentioned above are implemented and the power from any appropriate source is cut, and read and understand the specific product precautions of all relevant products carefully.
3. Before machinery/equipment is restarted, take measures to prevent unexpected operation and malfunction.

**4. Contact SMC beforehand and take special consideration of safety measures if the product is to be used in any of the following conditions.**

1. Conditions and environments outside of the given specifications, or use outdoors or in a place exposed to direct sunlight.
2. Installation on equipment in conjunction with atomic energy, railways, air navigation, space, shipping, vehicles, military, medical treatment, combustion and recreation, or equipment in contact with food and beverages, emergency stop circuits, clutch and brake circuits in press applications, safety equipment or other applications unsuitable for the standard specifications described in the product catalog.
3. An application which could have negative effects on people, property, or animals requiring special safety analysis.
4. Use in an interlock circuit, which requires the provision of double interlock for possible failure by using a mechanical protective function, and periodical checks to confirm proper operation.

**Caution**

**1. The product is provided for use in manufacturing industries.**  
 The product herein described is basically provided for peaceful use in manufacturing industries.  
 If considering using the product in other industries, consult SMC beforehand and exchange specifications or a contract if necessary.  
 If anything is unclear, contact your nearest sales branch.

**Limited warranty and Disclaimer/ Compliance Requirements**  
 The product used is subject to the following “Limited warranty and Disclaimer” and “Compliance Requirements”.  
 Read and accept them before using the product.

**Limited warranty and Disclaimer**

1. The warranty period of the product is 1 year in service or 1.5 years after the product is delivered, whichever is first.\*2)  
 Also, the product may have specified durability, running distance or replacement parts. Please consult your nearest sales branch.
2. For any failure or damage reported within the warranty period which is clearly our responsibility, a replacement product or necessary parts will be provided.  
 This limited warranty applies only to our product independently, and not to any other damage incurred due to the failure of the product.
3. Prior to using SMC products, please read and understand the warranty terms and disclaimers noted in the specified catalog for the particular products.

\*2) Vacuum pads are excluded from this 1 year warranty.  
 A vacuum pad is a consumable part, so it is warranted for a year after it is delivered.  
 Also, even within the warranty period, the wear of a product due to the use of the vacuum pad or failure due to the deterioration of rubber material are not covered by the limited warranty.

**Compliance Requirements**

1. The use of SMC products with production equipment for the manufacture of weapons of mass destruction (WMD) or any other weapon is strictly prohibited.
2. The exports of SMC products or technology from one country to another are governed by the relevant security laws and regulations of the countries involved in the transaction. Prior to the shipment of a SMC product to another country, assure that all local rules governing that export are known and followed.

**Caution**

**SMC products are not intended for use as instruments for legal metrology.**  
 Measurement instruments that SMC manufactures or sells have not been qualified by type approval tests relevant to the metrology (measurement) laws of each country. Therefore, SMC products cannot be used for business or certification ordained by the metrology (measurement) laws of each country.

**Safety Instructions** Be sure to read the “Handling Precautions for SMC Products” (M-E03-3) and “Operation Manual” before use.