

# 3-Color Display Digital Flow Switch



RoHS IP65

Applicable fluid **Dry air, N<sub>2</sub>**

## 3-color/2-screen display\*1

\*1 2-row display of main screen and sub screen



## Expanded flow range

Wide range of flow measurement with one product

Flow ratio\*2

# 100:1

\*2 Rated flow ratio is 10 : 1 for the current PF2A.

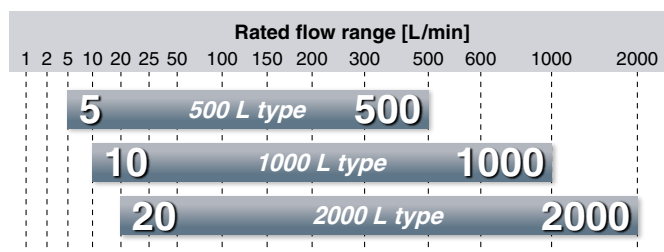

Smallest settable increment

# 1 L/min

Current PF2A: 5 L/min

## Compact, Space saving

Compared with the current PF2A

Weight

# 78% reduction

1100 g → 240 g

Mounting space

# 74% reduction

Compared with the PFMC7202-06 and PF2A703H-10

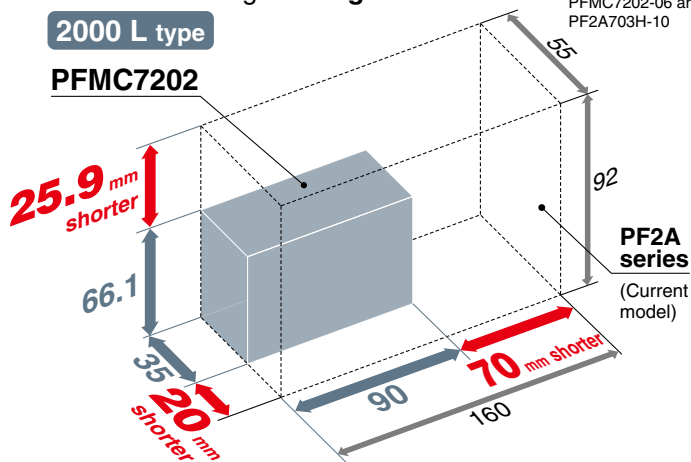

New

3-Screen Display

Digital Flow Monitor

Allows for the monitoring of remote lines



PFG300 Series

# PFMC Series



CAT.ES100-115B (A)

# 3-Color Display Digital Flow Switch

PFMC Series **p. 7**



## Rotary Display

Display can be rotated in increments of 45° to suit the installation conditions. Easy operation, improved visibility.

Counterclockwise 90°  
Clockwise 225°



## Functions **▶ Refer to pages 19 and 20 for details.**

- Output operation
- Display color
- Reference condition
- Display mode
- Response time
- External input function
- Forced output function
- Accumulated value hold
- Selection of display on sub screen
- Display OFF mode
- Setting of security code
- Peak/Bottom value display
- Keylock function
- Analog output free range function
- Error display function

Installation example

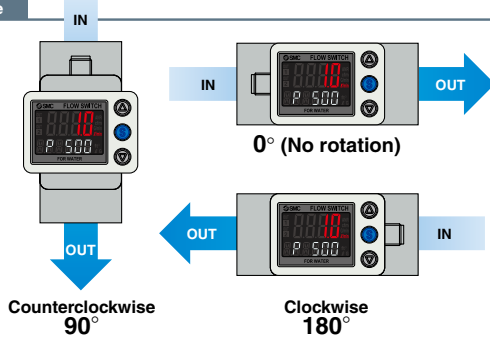

## Bypass Structure

Bypass structure with protruding part at the main piping, reduces the contact of moist air with the sensor, reducing degradation of the sensor and maintaining accuracy.

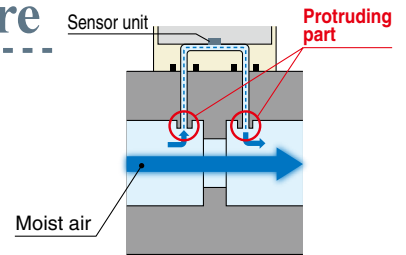

## Response Time

Can be selected from **50 ms (0.05 s) / 0.1 s / 0.5 s / 1.0 s / 2.0 s**

**Grease-free**

Response time can be set depending on application.

## Applications

■ Flow control of equipment, main line and branch line

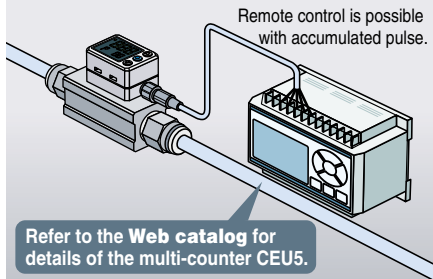

■ Accumulated indication shows the operating flow rate or residual amount (of N<sub>2</sub>, etc.) in a gas cylinder.

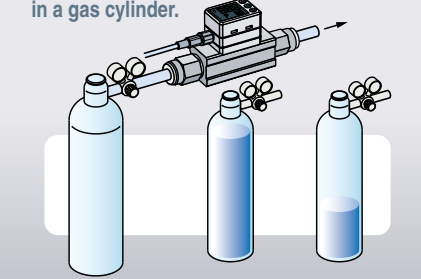

■ Flow control of the air for spray painting



Example of recommended pneumatic circuit

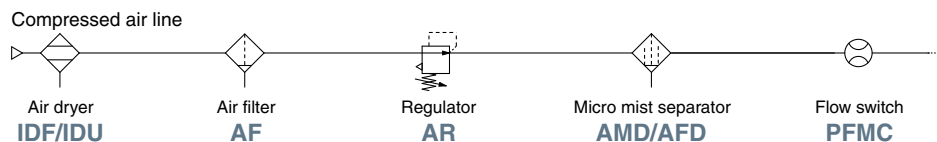

## Digital Flow Switch to Save Energy!

Flow control is necessary for promoting energy saving in any application. Saving energy starts from numerical control of the flow consumption of equipment and lines and clarification of the purpose and effect.

- Digital display allows **visualization**.
- **3-color/2-screen** display, Improved visibility
- **Remote control** is possible with accumulated pulse.

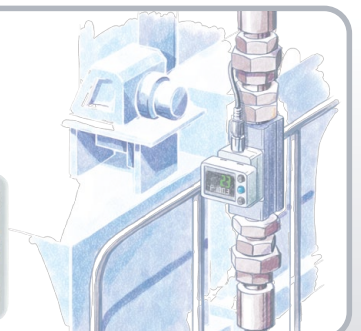

# 3-Screen Display Digital Flow Monitor

## PF300 Series p. 13



### Allows for the Monitoring of Remote Lines

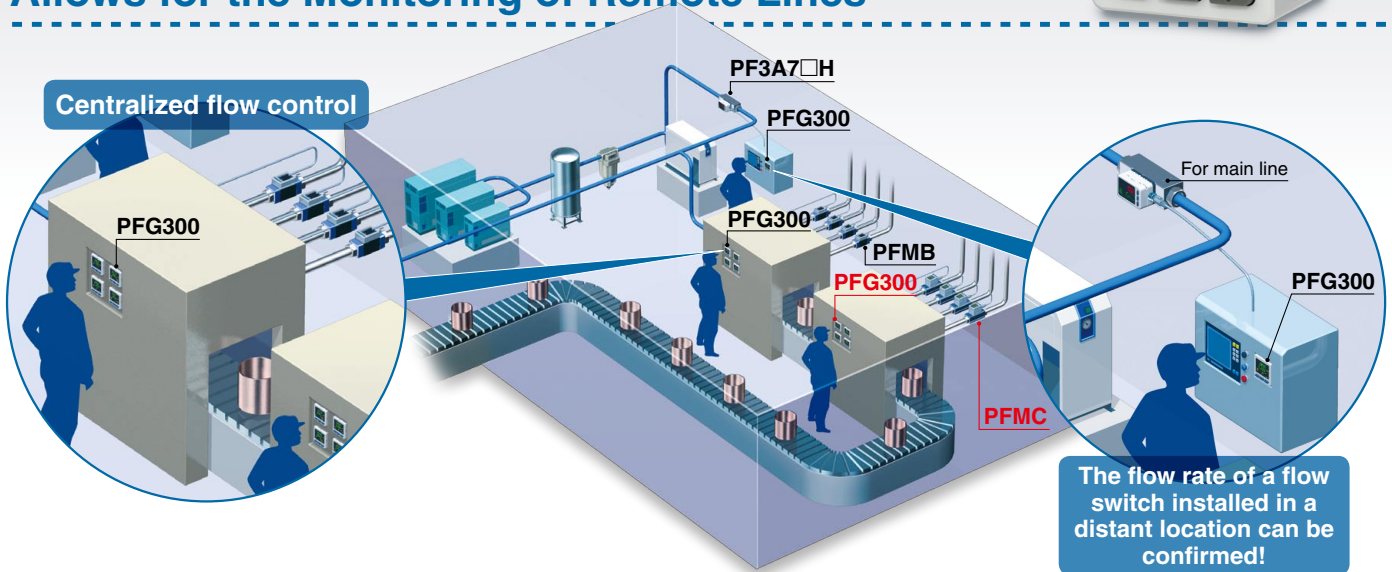

### Visualization of Settings

The sub screen (label) shows the item to be set.

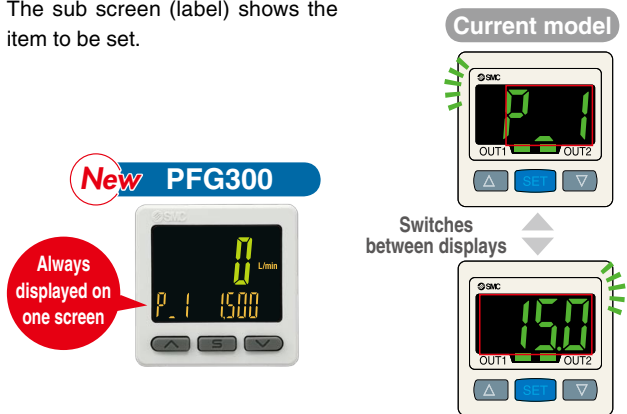

Mode Examples	Hysteresis mode					
	Normal output	Set value (Threshold value)	Reverse output	Set value (Threshold value)	Hysteresis	Set hysteresis value
	P.1	1500	n.1	1500	H.1	150
Mode Examples	Window comparator mode					
	Normal output/Lo side	Set value (Threshold value)	Normal output/Hi side	Set value (Threshold value)		
	P.L	900	P.H	1800		
	Reverse output/Lo side	Set value (Threshold value)	Reverse output/Hi side	Set value (Threshold value)		
	n.L	900	n.H	1800		

### Easy Screen Switching

It is possible to change the settings while checking the measured value.

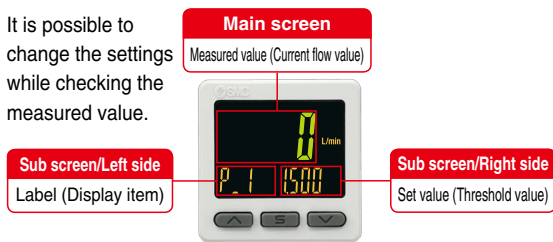

The sub screen can be switched by pressing the up/down buttons.

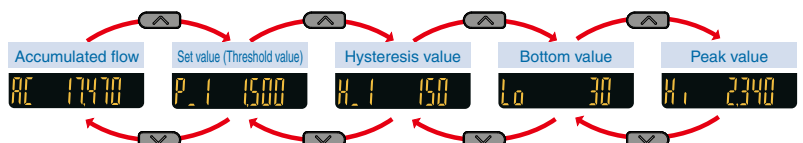

\* Either "Input of line name" or "Display OFF" can be added via the function settings.

### Simple 3-Step Setting

When the S button is pressed and the set value (P\_1) is being displayed, the set value (threshold value) can be set. When the S button is pressed and the hysteresis (H\_1) is being displayed, the hysteresis value can be set.

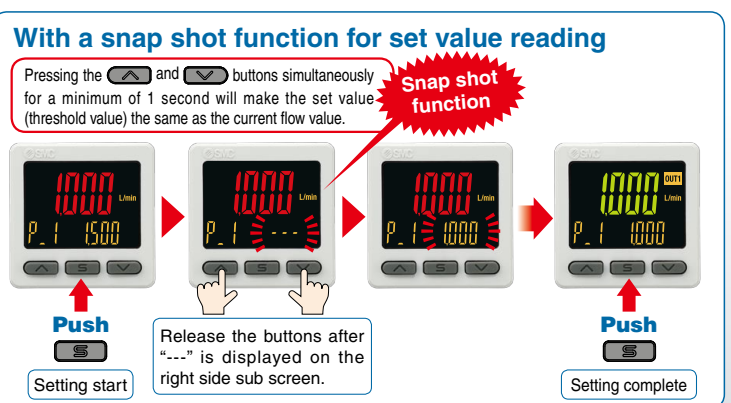
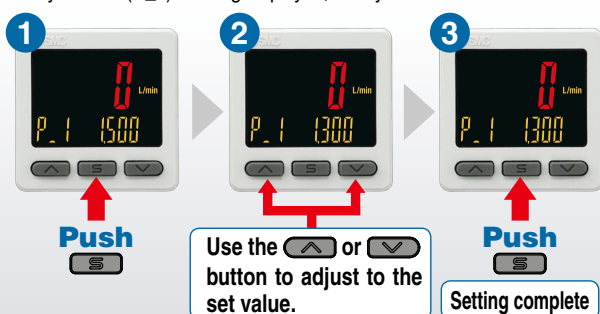

## NPN/PNP Switch Function

The number of stock items can be reduced.

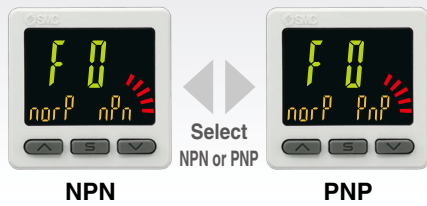

## Input Range Selection (for Pressure/Flow rate)

The displayed value to the sensor input can be set as required.

(Voltage input: 1 to 5 V/Current input: 4 to 20 mA)

Pressure switch/Flow switch can be displayed.

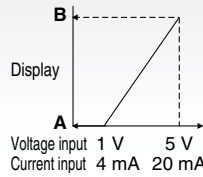

A is displayed for 1 V (or 4 mA).  
B is displayed for 5 V (or 20 mA).  
The range can be set as required.

## Analog output of 0 to 10 V is also available.

Voltage output	1 to 5 V 0 to 10 V	Switchable
Current output	4 to 20 mA	Fixed

■ Pressure Sensor for General Fluids/PSE570

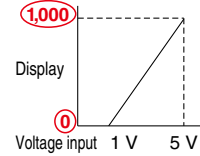

	A	B
PSE570	0	1,000
PSE573	-100	100
PSE574	0	500

Set A and B to the values shown in the table above.

## Convenient Functions

### ● Copy function

The settings of the master monitor can be copied to the slave monitors.

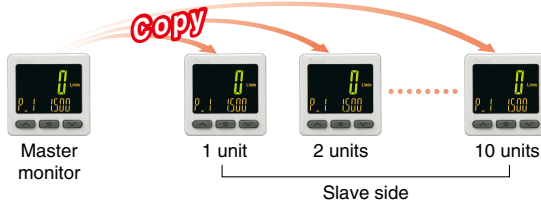

### ● Secret code setting function

The key locking function keeps unauthorized persons from tampering with the settings.

### ● Power-saving function

Power consumption is reduced by turning off the monitor.

Current consumption*1	Reduction rate*2
25 mA or less	Approx. 50% reduction

\*1 During normal operation \*2 In power-saving mode

### ● External input function

The accumulated value, peak value, and bottom value can be reset remotely.

## Compact & Lightweight

● Compact: Max. 6 mm shorter

● Lightweight: Max. 5 g lighter (30 g → 25 g)

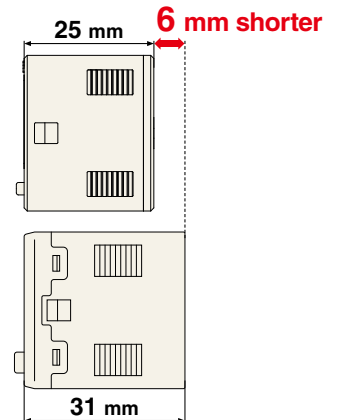

## Functions (▶ Refer to pages 21 to 23 for details.)

- Output operation
- Simple setting mode
- Display color
- Delay time setting
- Digital filter setting
- FUNC output switching function
- Selectable analog output function
- External input function
- Forced output function
- Accumulated value hold
- Peak/Bottom value display
- Setting of security code
- Keylock function
- Reset to the default settings
- Display with zero cut-off setting
- Selection of display on sub screen
- Analog output free range function
- Error display function
- Copy function
- Selection of power-saving mode

## Mounting

Bracket configuration allows for mounting in four orientations.

### Bracket A

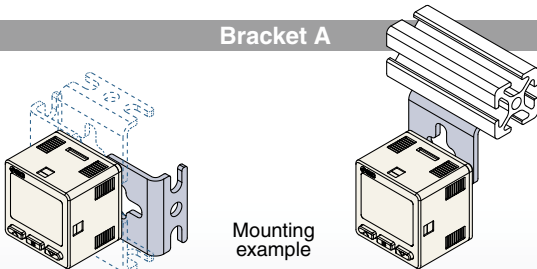

Mounting example

### Bracket B

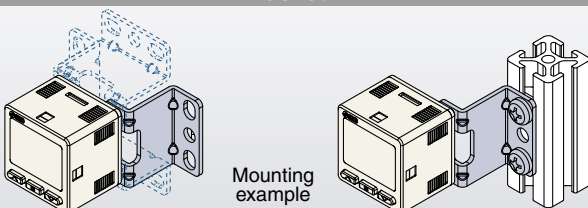

Mounting example

### Panel mount

Mountable side by side without clearance





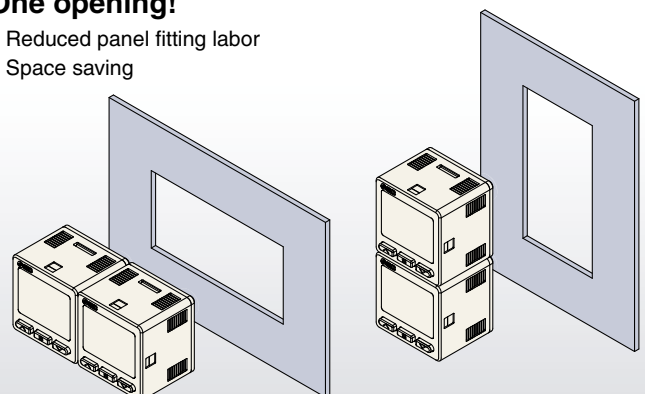



### One opening!

- Reduced panel fitting labor
- Space saving



# Flow Switch Flow Rate Variations

Series	Applicable fluid	Detection method	Rated flow range [L/min]									
			-3	-2	-1	-0.5	0	0.5	1	2	3	
<b>PFMV</b> 	Dry air N <sub>2</sub>	Thermal type (MEMS)					0	0.5				
							0	1				
							0	3				
									-0.5	0.5		
											-1	1
											-3	3

Series	Availability of the digital flow monitor PFG300	Applicable fluid	Detection method	Smallest settable increment	Rated flow range [L/min]																					
					0.2	0.5	1	2	5	10	20	25	50	100	150	200	300	500	600	1000	2000	3000	6000	12000		
<b>PFM</b> 	—	Dry air N <sub>2</sub> Ar CO <sub>2</sub>	Thermal type (MEMS)	0.01 L/min																						
				0.1 L/min																						
<b>PFMB</b>  	<b>PFG300</b> 	Dry air N <sub>2</sub>	Thermal type (MEMS) Bypass flow type	1 L/min																						
<b>PFMC</b> <p>p. 7</p> 	<b>PFG300</b> <p>p. 13</p> 	Dry air N <sub>2</sub>	Thermal type (MEMS) Bypass flow type	1 L/min																						
<b>PF2A</b> 	—	Air N <sub>2</sub>	Thermal type (Thermistor)	0.1 L/min																						
				0.5 L/min																						
				1 L/min																						
				2 L/min																						
				5 L/min																						
<b>PF3A7□H</b> 	<b>PFG300</b> 	Air N <sub>2</sub>	Thermal type (Platinum sensor) Bypass flow type	2 L/min																						
				5 L/min																						
				10 L/min																						

# Flow Switch Variations / Basic Performance Table

Series	PFMV	PFM	PFMB	PFMC <b>p. 7</b>	PF2A	PF3A7□H
Enclosure	IP40	IP40	IP40	IP65 [Monitor unit IP40]	IP65	IP65 [Monitor unit IP40]
Fluid	Dry air, N <sub>2</sub>	Dry air, N <sub>2</sub> , Ar, CO <sub>2</sub>	Dry air, N <sub>2</sub>	Dry air, N <sub>2</sub>	Air, N <sub>2</sub>	Air, N <sub>2</sub>
Setting	Digital	Digital	Digital	Digital	Digital	Digital
Rated flow range	0 to 0.5 L/min -0.5 to 0.5 L/min 0 to 1 L/min -1 to 1 L/min 0 to 3 L/min -3 to 3 L/min	0.2 to 10 L/min 0.5 to 25 L/min 1 to 50 L/min 2 to 100 L/min	2 to 200 L/min 5 to 500 L/min 10 to 1000 L/min 20 to 2000 L/min	5 to 500 L/min 10 to 1000 L/min 20 to 2000 L/min	1 to 10 L/min 5 to 50 L/min 10 to 100 L/min 20 to 200 L/min 50 to 500 L/min	30 to 3000 L/min 60 to 6000 L/min 120 to 12000 L/min
Power supply voltage	24 VDC ±10%	24 VDC ±10%	12 to 24 VDC ±10%	12 to 24 VDC ±10%	12 to 24 VDC ±10%	24 VDC ±10%
Temperature characteristics (25°C standard)	±2% F.S. (15 to 35°C) ±5% F.S. (0 to 50°C) [Monitor unit] ±0.5% F.S. (0 to 50°C)	±2% F.S. (15 to 35°C) ±5% F.S. (0 to 50°C)	±2% F.S. (15 to 35°C) ±5% F.S. (0 to 50°C) [Monitor unit] ±0.5% F.S. (0 to 50°C)	±2% F.S. (15 to 35°C) ±5% F.S. (0 to 50°C) [Monitor unit] ±0.5% F.S. (0 to 50°C)	±3% F.S. (15 to 35°C) ±5% F.S. (0 to 50°C)	±5% F.S. (0 to 50°C) [Monitor unit] ±0.5% F.S. (0 to 50°C)
Repeatability	±1% F.S. (Fluid: Dry air) Analog output: ±5% F.S. [Monitor unit] ±0.1% F.S. Analog output: ±0.5% F.S.	±1% F.S. (Fluid: Dry air) Analog output: ±3% F.S.	±1% F.S. (Fluid: Dry air) [Monitor unit] ±0.1% F.S.	±1% F.S. (Fluid: Dry air) [Monitor unit] ±0.1% F.S.	±1% F.S. (PF2A7□0) ±2% F.S. (PF2A7□1)	±1% F.S. [Monitor unit] ±0.1% F.S.
Hysteresis	Hysteresis mode: Variable Window comparator mode: Variable	Hysteresis mode: Variable Window comparator mode: Variable	Hysteresis mode: Variable Window comparator mode: Variable	Hysteresis mode: Variable Window comparator mode: Variable	Hysteresis mode: Variable Window comparator mode: Fixed (3 digits)	Hysteresis mode: Variable Window comparator mode: Variable
Output	NPN/PNP open collector Analog voltage output Analog current output	NPN/PNP open collector Accumulated pulse output Analog voltage output Analog current output	NPN/PNP open collector Accumulated pulse output Analog voltage output Analog current output	NPN/PNP open collector Accumulated pulse output Analog voltage output Analog current output	NPN/PNP open collector Accumulated pulse output	NPN/PNP open collector Accumulated pulse output Analog voltage output Analog current output
Display	[Monitor unit] 2-color LCD display	2-color LED display	2-color LED display 2-color LCD display [Monitor unit] 3-color LCD display	3-color LCD display	LED display	3-color LCD display

\* The monitor unit shows the PFG300 and PFMV3.

# CONTENTS

**3-Color Display** Digital Flow Switch *PFMC Series*

**3-Screen Display** Digital Flow Monitor *PFG300 Series*



## **3-Color Display** Digital Flow Switch **PFMC Series**

How to Order .....	p. 7
Specifications .....	p. 8
Flow Range .....	p. 9
Analog Output .....	p. 9
Pressure Loss .....	p. 9
IN Side Straight Piping Length and Accuracy .....	p. 9
Internal Circuits and Wiring Examples .....	p. 10
Construction: Parts in Contact with Fluid .....	p. 11
Dimensions .....	p. 12

## **3-Screen Display** Digital Flow Monitor **PFG300 Series**

How to Order .....	p. 13
Specifications .....	p. 14
Internal Circuits and Wiring Examples .....	p. 15
Dimensions .....	p. 16

**PFMC/Function Details**..... p. 19

**PFG300/Function Details**..... p. 21

**Safety Instructions**..... Back Cover

PFMC

PFG300

Function  
Details

# 3-Color Display

# Digital Flow Switch

# PFMC Series



## How to Order

PFMC 7 **501** - **04** - **A** - **M**

### Rated flow range

<b>501</b>	5 to 500 L/min
<b>102</b>	10 to 1000 L/min
<b>202</b>	20 to 2000 L/min

### Thread type

<b>Nil</b>	Rc
<b>N</b>	NPT
<b>F</b>	G*1

\*1 ISO228 compliant

### Port size

Symbol	Port size	Rated flow range		
		<b>501</b>	<b>102</b>	<b>202</b>
<b>04</b>	1/2	●	●	—
<b>06</b>	3/4	—	—	●

### Output specification

Symbol	OUT1	OUT2	Applicable monitor unit model
<b>A</b>	NPN	NPN	—
<b>B</b>	PNP	PNP	—
<b>C</b>	NPN	Analog (1 to 5 V)	PFG300 series
<b>D</b>	NPN	Analog (4 to 20 mA)	PFG310 series
<b>E</b> *2	PNP	Analog (1 to 5 V)	PFG300 series
<b>F</b> *2	PNP	Analog (4 to 20 mA)	PFG310 series
<b>G</b> *2	NPN	External input*3	—
<b>H</b> *2	PNP	External input*3	—

\*2 Made to order

\*3 Can be selected from accumulated value external reset and peak/bottom value reset.

### Calibration certificate

<b>Nil</b>	None
<b>A</b> *8	Yes

\*8 Made to order: Certificate in both English and Japanese

### Option 2

<b>Nil</b>	No bracket
<b>R</b>	With bracket*7

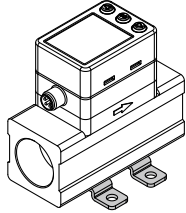

\*7 Each option is shipped together with the product, but not assembled.

### Unit specification

<b>Nil</b>	Units selection function*5
<b>M</b>	SI unit only*6

\*5 This product is for overseas use only according to the New Measurement Act. (The SI unit type is provided for use in Japan.)

\*6 Fixed unit: Instantaneous flow: L/min, Accumulated flow: L

### Option 1

<b>Nil</b>	With lead wire and M8 connector (3 m)*4
<b>N</b>	Without lead wire and M8 connector

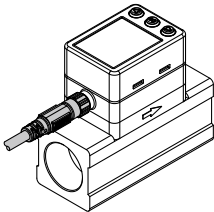

\*4 Each option is shipped together with the product, but not assembled.

### Options/Part Nos.

When only optional parts are required, order with the part numbers listed below.

Part no.	Option	Note
<b>ZS-40-A</b>	Lead wire and M8 connector	Length: 3 m
<b>ZS-42-A</b>	Bracket	Mounting screw for PFMC7501/7102 (M3 x 5, 2 pcs.)
<b>ZS-42-B</b>	Bracket	Mounting screw for PFMC7202 (M3 x 5, 2 pcs.)



Refer to the **Web Catalog** for flow switch precautions. For details on the specific product precautions, refer to the "Operation Manual" on the SMC website. Click [here](#) for details.

**Specifications**

Model		PFMC7501	PFMC7102	PFMC7202	
Fluid	Applicable fluid	Dry air, N <sub>2</sub> (Air quality grade is JIS B 8392-1 1.1.2 to 1.6.2, ISO 8573-1 1.1.2 to 1.6.2.)			
	Fluid temperature range	0 to 50°C			
Flow	Detection method	Thermal type			
	Rated flow range	5 to 500 L/min	10 to 1000 L/min	20 to 2000 L/min	
	Set point range	Instantaneous flow	5 to 525 L/min	10 to 1050 L/min	20 to 2100 L/min
		Accumulated flow	0 to 999,999,990 L		
	Smallest settable increment	Instantaneous flow	1 L/min		
		Accumulated flow	10 L		
	Accumulated volume per pulse (Pulse width = 50 ms)	1 L/pulse	10 L/pulse		
Accumulated value hold function *1	Intervals of 2 mins or 5 mins can be selected.				
Pressure	Rated pressure range	0 to 0.8 MPa			
	Proof pressure	1.2 MPa			
	Pressure loss	Refer to "Pressure Loss" graph.			
	Pressure characteristics *2	±5% F.S. (0 to 0.8 MPa, 0.6 MPa standard)			
Electrical	Power supply voltage	12 to 24 VDC ±10% Ripple (p-p) 10% or less			
	Current consumption	55 mA or less			
	Protection	Polarity protection			
Accuracy	Display accuracy	±3% F.S.			
	Analog output accuracy	±3% F.S.			
	Repeatability	±1% F.S. (±2% F.S. when response time is set to 0.05 s)			
	Temperature characteristics	±5% F.S. (0 to 50°C, 25°C standard)			
Switch output	Output type	NPN open collector PNP open collector			
	Output mode	Select from Hysteresis, Window comparator, Accumulated output or Accumulated pulse output modes.			
	Switch operation	Select from Normal or Reversed output.			
	Max. load current	80 mA			
	Max. applied voltage (NPN only)	28 VDC			
	Internal voltage drop (Residual voltage)	NPN output type: 1 V or less (at load current of 80 mA) PNP output type: 1.5 V or less (at load current of 80 mA)			
	Response time *3	Select from 0.05 s, 0.1 s, 0.5 s, 1 s, or 2 s			
	Hysteresis *4	Variable from 0			
	Protection	Short circuit protection			
Analog output *5	Output type	Voltage output: 1 to 5 V, Current output: 4 to 20 mA Output impedance: Approx. 1 kΩ			
	Impedance	Voltage output	Maximum load impedance at power supply voltage of 24 V: 600 Ω, at power supply voltage of 12 V: 300 Ω		
		Current output	Minimum load impedance: 50 Ω		
	Response time *6	Linked with the response time of the switch output.			
External input *7	External input	Input voltage: 0.4 V or less (Reed or Solid state) for 30 ms or longer			
	Input mode	Accumulated value external reset, Peak/Bottom value reset			
Display	Reference condition *8	Select from Standard condition or Normal condition.			
	Unit *9	Instantaneous flow	L/min, cfm (ft <sup>3</sup> /min)		
		Accumulated flow	L, ft <sup>3</sup>		
	Display range	Instantaneous flow	-25 to 525 L/min (Displays [0] when value is within -4 to 4 L/min range.)	-50 to 1050 L/min (Displays [0] when value is within -9 to 9 L/min range.)	-100 to 2100 L/min (Displays [0] when value is within -19 to 19 L/min range.)
		Accumulated flow *10	0 to 999,999,999 L		
	Minimum display unit	Instantaneous flow	1 L/min		
		Accumulated flow	10 L		
	Display	LCD, 2-screen display (Main screen/Sub screen) Main screen: Red/Green, Sub screen: White Main screen: 4 digits, 7 segments, Sub screen: 6 digits, 11 segments			
Indicator LED	LED ON when switch output is ON. (OUT1/OUT2: Orange)				
Environment	Enclosure	IP65			
	Withstand voltage	250 VAC for 1 min between terminals and housing			
	Insulation resistance	2 MΩ or more (50 VDC measured via megohmmeter) between terminals and housing			
	Operating temperature range	Operating: 0 to 50°C, Stored: -10 to 60°C (No condensation or freezing)			
Operating humidity range	Operating/Stored: 35 to 85% RH (No condensation or freezing)				
Standards	CE, UL (CSA), RoHS				
Piping specification	Rc1/2, NPT1/2, G1/2		Rc3/4, NPT3/4, G3/4		
Materials of parts in contact with fluid	Stainless steel 304, PPS, Aluminum alloy, HNBR, Si, Au, GE4F				
Weight	Piping specification	Rc thread NPT thread	160 g	240 g	
		G thread	170 g	245 g	
	Lead wire	+80 g			
	Bracket	+25 g		+30 g	

\*1 When using the accumulated value hold function, use the operating conditions to calculate the product life, and do not exceed it. The maximum access limit of the memory device is 1 million times. If the product is operated 24 hours per day, the product life will be as follows:  
 • 5 min interval: life is calculated as 5 min x 1 million = 5 million min = 9.5 years  
 • 2 min interval: life is calculated as 2 min x 1 million = 2 million min = 3.8 years  
 If the accumulated value external reset is repeatedly used, the product life will be shorter than the calculated life.  
 \*2 Do not release the OUT side piping part of the product directly to the atmosphere without connecting piping. If the product is used with the piping port released to atmosphere, accuracy may vary.  
 \*3 The time from when the flow is changed by a step input (when the flow rate changes from 0 to the maximum flow instantaneously) until the switch output turns ON (or OFF) when set at 90% of the rated flow rate.  
 \*4 If the flow fluctuates around the set value, be sure to keep a sufficient margin.

Otherwise, chattering will occur.  
 \*5 Setting is only possible for models with analog output.  
 \*6 The time from when the flow is changed as a step input (when the flow rate changes from 0 to the maximum flow instantaneously) until the analog output reaches 90% of the rated flow rate.  
 \*7 Setting is only possible for models with external input.  
 \*8 The flow rate given in the specification is the value at standard condition.  
 \*9 Setting is only possible for models with the units selection function.  
 \*10 The accumulated flow display is the upper 3-digit and lower 6-digit (total of 9 digits) display. The position of the dots on the upper part of the screen indicates which digits are displayed.  
 \* Products with tiny scratches, smears, or display color or brightness variations which do not affect the performance of the product are verified as conforming products.

PFMC

PF300

Function Details

# PFMC Series

## Flow Range

Model	Flow range					
	-100 L/min	0 L/min	200 L/min	500 L/min	1000 L/min	2000 L/min
PFMC7501		5 L/min	500 L/min			
		5 L/min	525 L/min			
		-25 L/min	525 L/min			
PFMC7102		10 L/min	1000 L/min			
		10 L/min	1050 L/min			
		-50 L/min	1050 L/min			
PFMC7202		20 L/min	2000 L/min			
		20 L/min	2100 L/min			
	-100 L/min		2100 L/min			

Rated flow range  
  Set point range  
  Display range

## Analog Output

### Flow/Analog Output

	A	B	C
Voltage output	1 V	1.04 V	5 V
Current output	4 mA	4.16 mA	20 mA

Model	Minimum value of the rated flow range	Maximum value of the rated flow range
PFMC7501	5 L/min	500 L/min
PFMC7102	10 L/min	1000 L/min
PFMC7202	20 L/min	2000 L/min

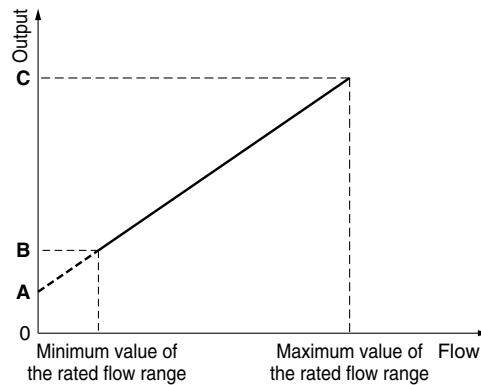

## Pressure Loss (Reference Data)

### PFMC7501 (for 500 L/min)

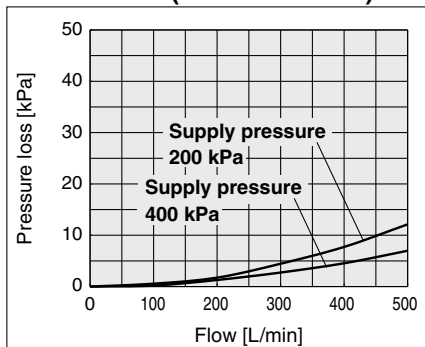

### PFMC7102 (for 1000 L/min)

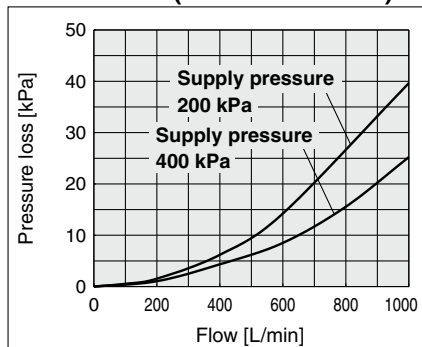

### PFMC7202 (for 2000 L/min)

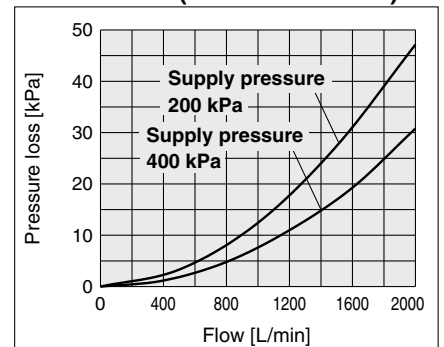

## IN Side Straight Piping Length and Accuracy (Reference Data)

- The piping on the IN side must have a straight section of piping with a length of 8 cm or more. If a straight section of piping is not installed, the accuracy can vary by approximately  $\pm 2\%$  F.S.
- \* "Straight section" means a part of the piping without any bends or rapid changes in the cross sectional area.
- When the PFMC7501 or 7102 is connected to tubing, use a tube I.D. 9 mm or more just before the product. The accuracy can vary by approximately  $\pm 2\%$  F.S. when such tubing is not used.

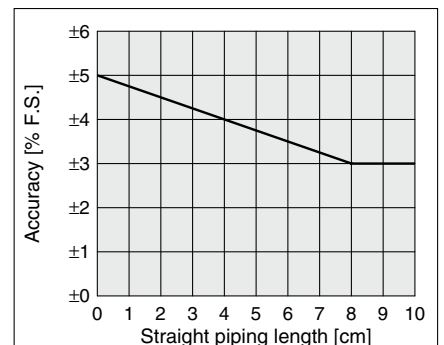
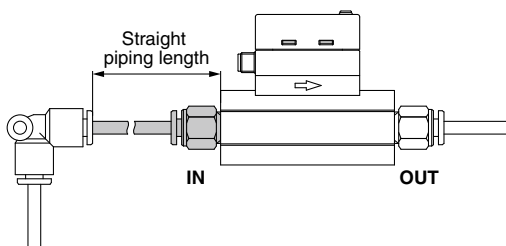

**Internal Circuits and Wiring Examples**

**NPN (2 outputs) type**

PFMC7□□□-□□-**A**□-□□□

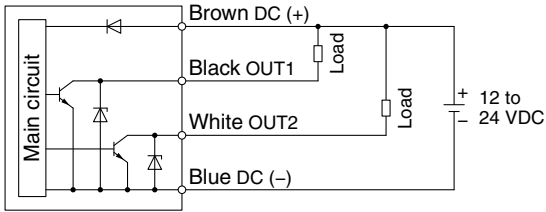

Max. applied voltage: 28 V, Max. load current: 80 mA, Internal voltage drop: 1 V or less

**PNP (2 outputs) type**

PFMC7□□□-□□-**B**□-□□□

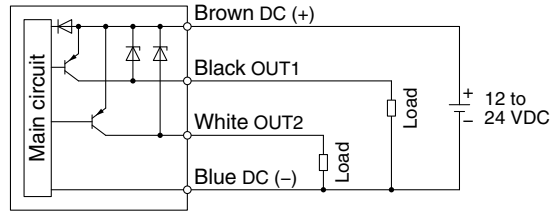

Max. load current: 80 mA, Internal voltage drop: 1.5 V or less

**NPN (1 output) + Analog (1 to 5 V) output type**

PFMC7□□□-□□-**C**□-□□□

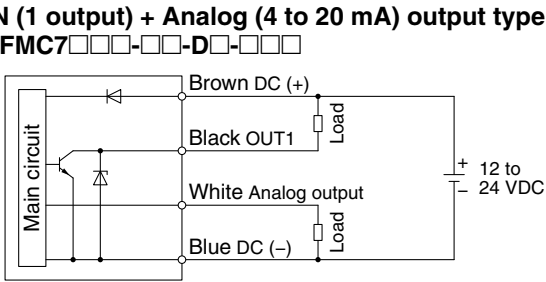

Max. applied voltage: 28 V, Max. load current: 80 mA, Internal voltage drop: 1 V or less  
 C: Analog output: 1 to 5 V  
 Output impedance: 1 kΩ  
 D: Analog output: 4 to 20 mA  
 Max. load impedance: 600 Ω  
 Min. load impedance: 50 Ω

**PNP (1 output) + Analog (1 to 5 V) output type**

PFMC7□□□-□□-**E**□-□□□

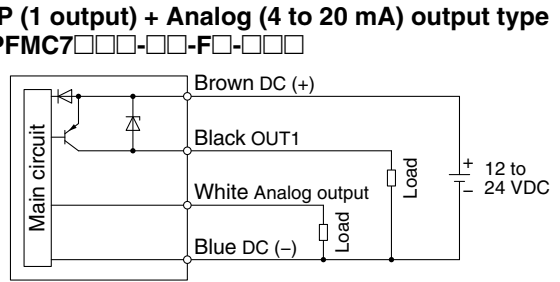

Max. load current: 80 mA, Internal voltage drop: 1.5 V or less  
 E: Analog output: 1 to 5 V  
 Output impedance: 1 kΩ  
 F: Analog output: 4 to 20 mA  
 Max. load impedance: 600 Ω  
 Min. load impedance: 50 Ω

**NPN (1 output) + External input type**

PFMC7□□□-□□-**G**□-□□□

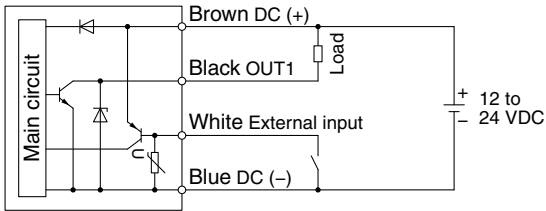

Max. applied voltage: 28 V, Max. load current: 80 mA, Internal voltage drop: 1 V or less  
 External input: Input voltage 0.4 V or less (Reed or Solid state input) for 30 ms or longer

**PNP (1 output) + External input type**

PFMC7□□□-□□-**H**□-□□□

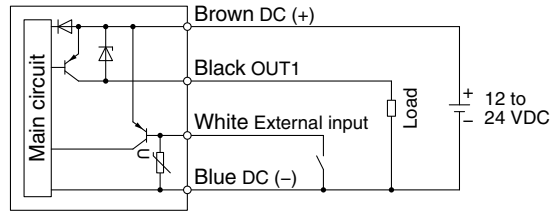

Max. load current: 80 mA, Internal voltage drop: 1.5 V or less  
 External input: Input voltage 0.4 V or less (Reed or Solid state input) for 30 ms or longer

**Accumulated pulse output wiring examples**

**NPN (2 outputs) type**

PFMC7□□□-□□-**A**□-□□□

**NPN (1 output) + Analog output type**

PFMC7□□□-□□-**C**□-□□□

PFMC7□□□-□□-**D**□-□□□

**NPN (1 output) + External input type**

PFMC7□□□-□□-**G**□-□□□

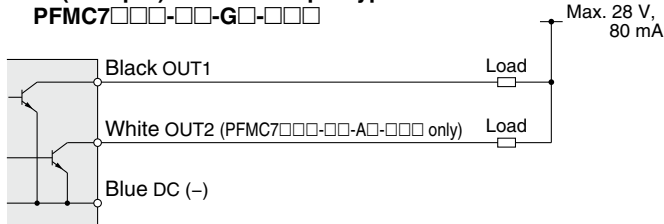

**PNP (2 outputs) type**

PFMC7□□□-□□-**B**□-□□□

**PNP (1 output) + Analog output type**

PFMC7□□□-□□-**E**□-□□□

PFMC7□□□-□□-**F**□-□□□

**PNP (1 output) + External input type**

PFMC7□□□-□□-**H**□-□□□

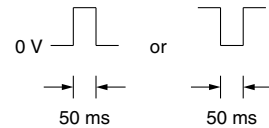
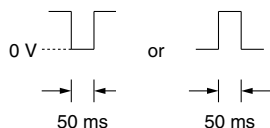
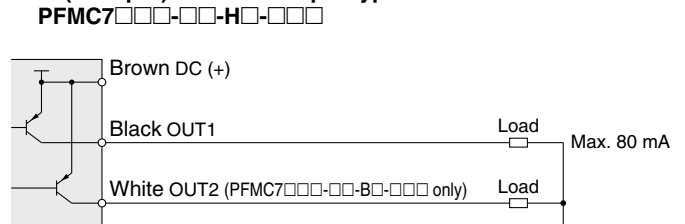

# PFMC Series

## Construction: Parts in Contact with Fluid

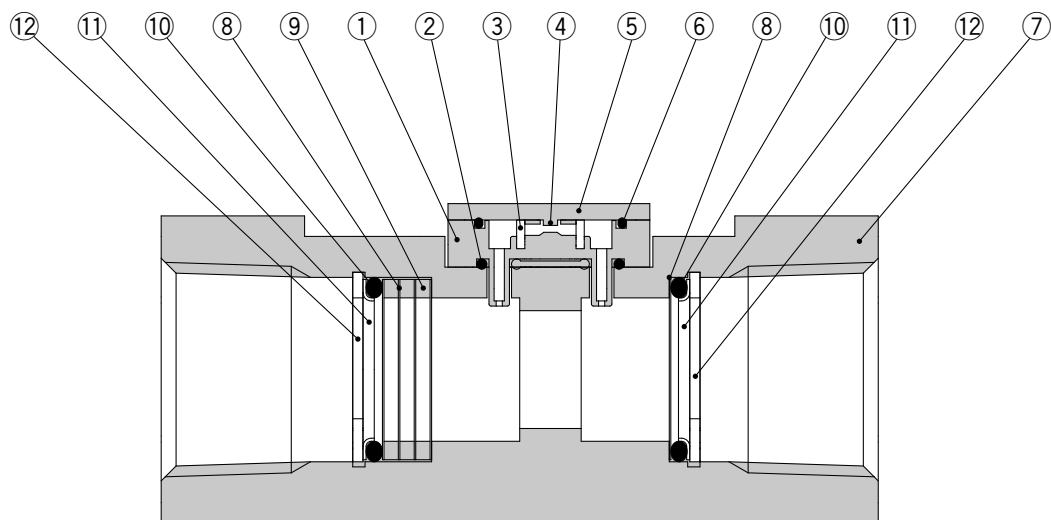

### Component Parts

No.	Description	Material	Note
1	<b>Sensor body</b>	PPS	
2	<b>Gasket</b>	HNBR	
3	<b>Flow rectifier</b>	Stainless steel 304	
4	<b>Sensor chip</b>	Silicon	
5	<b>Printed circuit board</b>	GE4F	
6	<b>Gasket</b>	HNBR	
7	<b>Body</b>	Aluminum alloy	Anodized
8	<b>Mesh</b>	Stainless steel 304	
9	<b>Spacer</b>	PPS	
10	<b>O-ring</b>	HNBR	
11	<b>Holder</b>	Stainless steel 304	
12	<b>C retaining ring</b>	Stainless steel 304	

**Dimensions**

**PFMC7501/7102/7202**

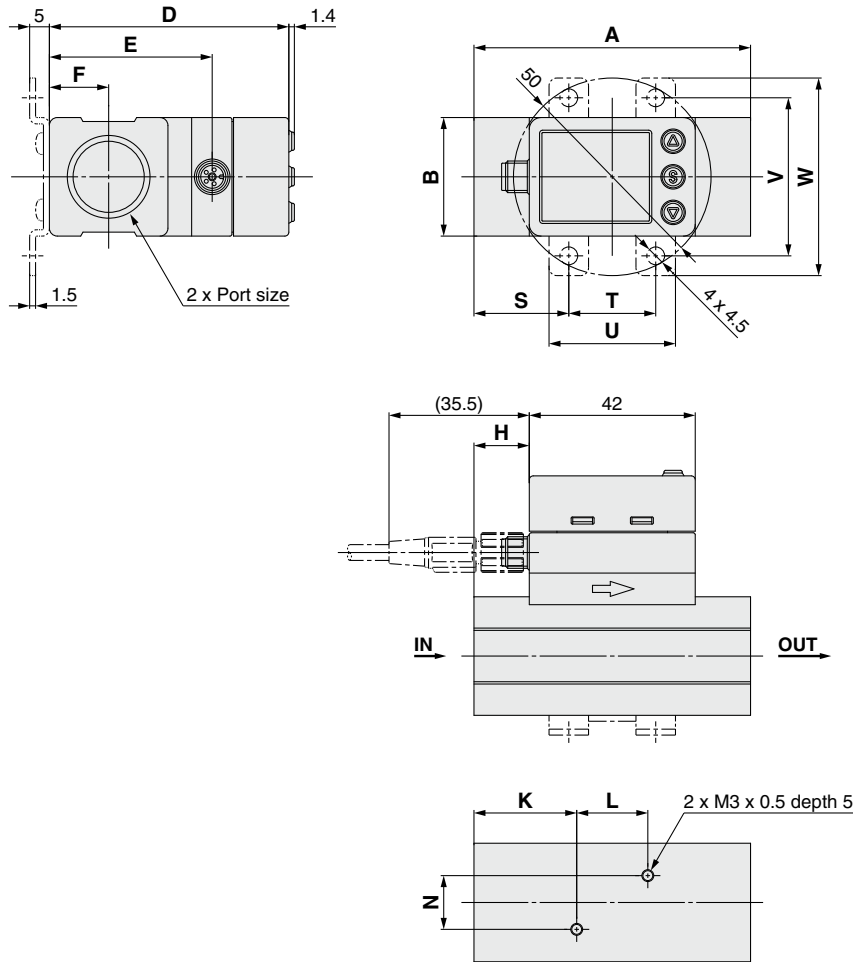

Model	Symbol	Port size	A	B	D	E	F	H	K	L	N
<b>PFMC7501/7102</b>		Rc1/2, NPT1/2	70	30	60.6	41.2	15	14	26	18	13.6
<b>PFMC7202</b>		Rc3/4, NPT3/4, G3/4	90	35	66.1	46.7	17.5	24	31	28	16.8
<b>PFMC7501/7102</b>		G1/2	76	30	60.6	41.2	15	14	26	18	13.6

Model	Symbol	Bracket dimensions				
		S	T	U	V	W
<b>PFMC7501/7102</b>		24	22	32	40	50
<b>PFMC7202</b>		30	30	42	48	58

**Lead wire and M8 connector (Part no.: ZS-40-A)**

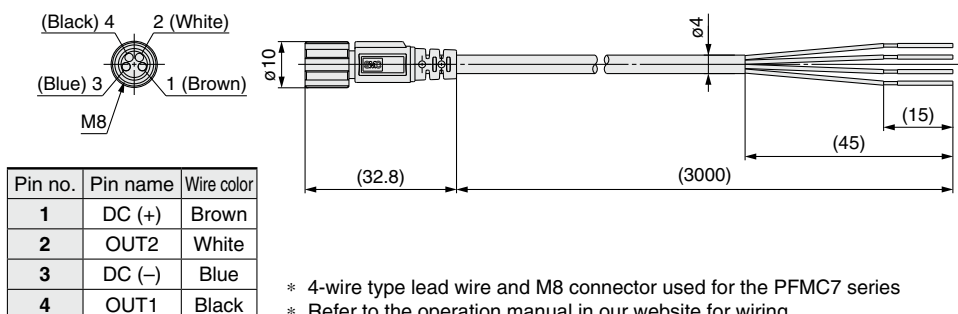

Pin no.	Pin name	Wire color
1	DC (+)	Brown
2	OUT2	White
3	DC (-)	Blue
4	OUT1	Black

\* 4-wire type lead wire and M8 connector used for the PFMC7 series  
 \* Refer to the operation manual in our website for wiring.

**Cable Specifications**

Conductor	Nominal cross section	AWG23
	Outside diameter	Approx. 0.7 mm
Insulator	Material	Heat-resistant PVC
	Outside diameter	Approx. 1.1 mm
	Color	Brown, White, Black, Blue
Sheath	Material	Heat-and oil-resistant PVC
Finished outside diameter		$\phi 4$

# 3-Screen Display

# Digital Flow Monitor

# PFG300 Series



## How to Order

**PFG 3 0 0 - RT - M - L**

### Type

<b>3</b>	Remote type monitor unit
----------	--------------------------

### Input specification

Symbol	Description	Applicable flow switch model
<b>0</b>	Voltage input	PFMC7□-C/E series
<b>1</b>	Current input	PFMC7□-D/F series

### Output specification

<b>RT</b>	2 outputs (NPN/PNP switching type) + Analog voltage output*1, 2
<b>SV</b>	2 outputs (NPN/PNP switching type) + Analog current output*2
<b>XY</b>	2 outputs (NPN/PNP switching type) + Copy function

\*1 Can switch between 1 to 5 V and 0 to 10 V

\*2 Can be switched to external input or copy function

### Unit specification

<b>Nil</b>	Units selection function*3
<b>M</b>	SI unit only*4

\*3 This product is for overseas use only according to the New Measurement Act. (The SI unit type is provided for use in Japan.)

\*4 Fixed unit: Instantaneous flow: L/min  
Accumulated flow: L

### Option 4

	Operation manual	Calibration certificate
<b>Nil</b>	<input type="radio"/>	<input type="checkbox"/>
<b>Y</b>	<input type="checkbox"/>	<input type="checkbox"/>
<b>K</b>	<input type="radio"/>	<input type="radio"/>
<b>T</b>	<input type="checkbox"/>	<input type="radio"/>

### Option 3

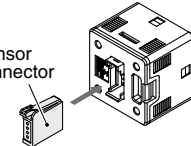
<b>Nil</b>	None
<b>C</b>	ZS-28-CA-4 

### Option 1

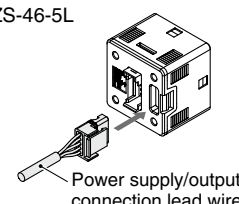
Symbol	Description
<b>Nil</b>	Without lead wire
<b>L</b>	Power supply/output connection lead wire (Lead wire length: 2 m) 

### Option 2

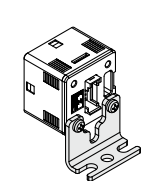
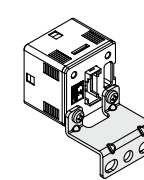
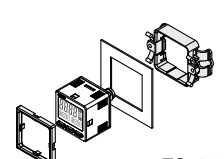
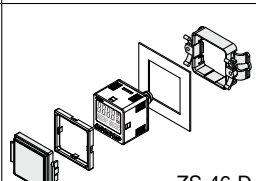
Symbol	Description
<b>Nil</b>	None
<b>A1</b>	Bracket A (Vertical mounting) 
<b>A2</b>	Bracket B (Horizontal mounting) 
<b>B</b>	Panel mount adapter 
<b>D</b>	Panel mount adapter + Front protection cover 

### Options/Part Nos.

When only optional parts are required, order with the part numbers listed below.

Part no.	Option	Note
<b>ZS-28-CA-4</b>	Sensor connector	For PFMC
<b>ZS-46-A1</b>	Bracket A	Tapping screw: Nominal size 3 x 8 L (2 pcs.)
<b>ZS-46-A2</b>	Bracket B	Tapping screw: Nominal size 3 x 8 L (2 pcs.)
<b>ZS-46-B</b>	Panel mount adapter	
<b>ZS-46-D</b>	Panel mount adapter + Front protection cover	
<b>ZS-46-5L</b>	Power supply/output connection lead wire	5-core, 2 m
<b>ZS-27-01</b>	Front protection cover	

### Connection Example

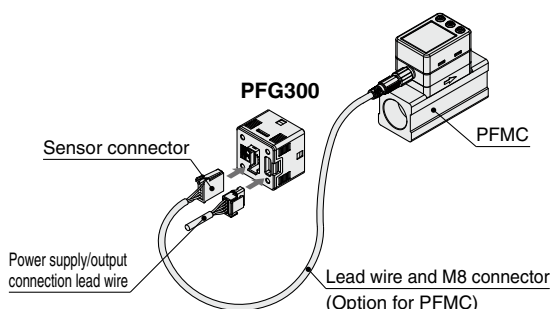

Refer to the **Web Catalog** for flow switch precautions. For details on the specific product precautions, refer to the "Operation Manual" on the SMC website. Click [here](#) for details.

## Specifications

Model		PFG300 series			
Applicable SMC flow switch	Model	PFMC7501	PFMC7102	PFMC7202	
	<b>Rated flow range</b> *1	5 to 500 L/min	10 to 1000 L/min	20 to 2000 L/min	
Flow	<b>Set point range</b>	Instantaneous flow	-25 to 525 L/min	-50 to 1050 L/min	
		Accumulated flow	0 to 999,999,999,990 L		
	<b>Smallest settable increment</b>	Instantaneous flow	1 L/min		
		Accumulated flow	10 L		
	<b>Accumulated volume per pulse (Pulse width = 50 ms)</b>	1 L/pulse		10 L/pulse	
	<b>Accumulated value hold function</b> *3	Intervals of 2 or 5 minutes can be selected. The stored accumulated flow is held even when the power supply is OFF.			
Electrical	<b>Power supply voltage</b>	12 to 24 VDC ±10%			
	<b>Current consumption</b>	25 mA or less			
	<b>Protection</b>	Polarity protection			
Accuracy	<b>Display accuracy</b>	±0.5% F.S. ± Minimum display unit (Ambient temperature at 25°C)			
	<b>Analog output accuracy</b>	±0.5% F.S. (Ambient temperature at 25°C)			
	<b>Repeatability</b>	±0.1% F.S. ± Minimum display unit			
	<b>Temperature characteristics</b>	±0.5% F.S. (Ambient temperature: 0 to 50°C, 25°C standard)			
Switch output	<b>Output type</b>	Select from NPN or PNP open collector output.			
	<b>Output mode</b>	Select from Hysteresis, Window comparator, Accumulated output, Accumulated pulse output, Error output, or Switch output OFF modes.			
	<b>Switch operation</b>	Select from Normal or Reversed output.			
	<b>Max. load current</b>	80 mA			
	<b>Max. applied voltage (NPN only)</b>	30 VDC			
	<b>Internal voltage drop (Residual voltage)</b>	NPN output: 1 V or less (at load current of 80 mA), PNP output: 1.5 V or less (at load current of 80 mA)			
	<b>Response time</b> *2	3 ms or less			
	<b>Delay time</b> *2	Select from 0.00, 0.05 to 0.1 s (increment of 0.01 s), 0.1 to 1.0 s (increment of 0.1 s), 1 to 10 s (increment of 1 s), 20 s, 30 s, 40 s, 50 s, or 60 s			
	<b>Hysteresis</b> *4	Variable from 0			
Analog output*5	<b>Protection</b>	Short circuit protection			
	<b>Output type</b>	Voltage output: 1 to 5 V, 0 to 10 V (only when the power supply voltage is 24 VDC) Current output: 4 to 20 mA (0 L/min to maximum value of the rated flow)			
	<b>Impedance</b>	Voltage output	Output impedance: 1 kΩ		
		Current output	Maximum load impedance: 300 Ω (at power supply voltage of 12 V), 600 Ω (at power supply voltage of 24 VDC)		
	<b>Response time</b> *2	50 ms or less			
External input*6	<b>External input</b>	Input voltage: 0.4 V or less (Reed or Solid state) for 30 ms or longer			
	<b>Input mode</b>	Select from Accumulated value external reset or Peak/Bottom value reset.			
Sensor input	<b>Input type</b>	Voltage input: 1 to 5 VDC (Input impedance: 1 MΩ), Current input: 4 to 20 mA DC (Input impedance: 51 Ω) (0 L/min to maximum value of the rated flow)			
	<b>Connection method</b>	Connector (e-CON)			
	<b>Protection</b>	Over voltage protection (Up to 26.4 VDC)			
Display	<b>Display mode</b>	Select from Instantaneous flow or Accumulated flow.			
	<b>Unit</b> *7	Instantaneous flow	L/min, cfm (ft <sup>3</sup> /min)		
		Accumulated flow	L, ft <sup>3</sup> , L x 10 <sup>6</sup> , ft <sup>3</sup> x 10 <sup>6</sup>		
	<b>Display range</b>	Instantaneous flow	-25 to 525 L/min	-50 to 1050 L/min	-100 to 2100 L/min
		Accumulated flow*9	0 to 999,999,999,990 L		
	<b>Minimum display unit</b>	Instantaneous flow	1 L/min		
		Accumulated flow	10 L		
	<b>Display type</b>	LCD			
	<b>Number of displays</b>	3-screen display (Main screen, Sub screen)			
	<b>Display color</b>	1) Main screen: Red/Green, 2) Sub screen: Orange			
<b>Number of display digits</b>	1) Main screen: 5 digits (7 segments), 2) Sub screen: 9 digits (7 segments)				
<b>Indicator LED</b>	LED ON when switch output is ON. OUT1/2: Orange				
Digital filter*8	Select from 0.00, 0.05 to 0.1 s (increment of 0.01 s), 0.1 to 1.0 s (increment of 0.1 s), 1 to 10 s (increment of 1 s), 20 s, or 30 s				
Environment	<b>Enclosure</b>	IP40			
	<b>Withstand voltage</b>	1000 VAC for 1 min between terminals and housing			
	<b>Insulation resistance</b>	50 MΩ or more (500 VDC measured via megohmmeter) between terminals and housing			
	<b>Operating temperature range</b>	Operating: 0 to 50°C, Stored: -10 to 60°C (No condensation or freezing)			
	<b>Operating humidity range</b>	Operating/Stored: 35 to 85% RH (No condensation or freezing)			
Standards	CE, RoHS				
Weight	<b>Body</b>	25 g (Excluding the power supply/output connection lead wire)			
	<b>Lead wire with connector</b>	+39 g			

\*1 Rated flow range of the applicable flow switch

\*2 Value without digital filter (at 0.00 s)

\*3 When using the accumulated value hold function, use the operating conditions to calculate the product life, and do not exceed it. The maximum access limit of the memory device is 1.5 million times. If the product is operated 24 hours per day, the product life will be as follows:

- 5 min interval: life is calculated as 5 min x 1.5 million = 7.5 million min = 14.3 years
- 2 min interval: life is calculated as 2 min x 1.5 million = 3 million min = 5.7 years

If the accumulated value external reset is repeatedly used, the product life will be shorter than the calculated life.

\*4 If the flow fluctuates around the set value, be sure to keep a sufficient margin. Otherwise, chattering will occur.

\*5 Setting is only possible for models with analog output.

\*6 Setting is only possible for models with external input.

\*7 Setting is only possible for models with the units selection function.

\*8 The response time indicates when the set value is 90% in relation to the step input.

\*9 The accumulated flow display is the upper 6-digit and lower 6-digit (total of 12 digits) display. When the upper digits are displayed, x 10<sup>6</sup> lights up.

\* Products with tiny scratches, smears, or display color or brightness variations which do not affect the performance of the product are verified as conforming products.

# PFG300 Series

## Internal Circuits and Wiring Examples

**-XY**  
**-RT**  
**-SV**  
**NPN (2 outputs) + Copy function**

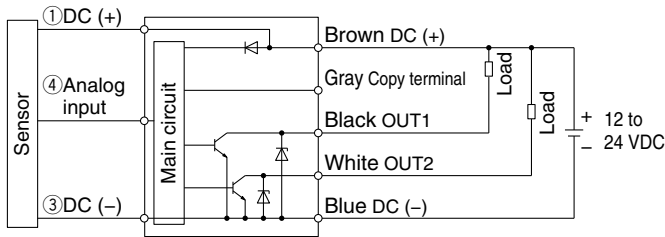

**-XY**  
**-RT**  
**-SV**  
**PNP (2 outputs) + Copy function**

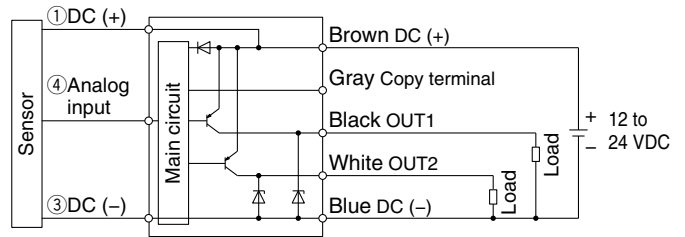

**-RT: NPN (2 outputs) + Analog voltage output**  
**-SV: NPN (2 outputs) + Analog current output**

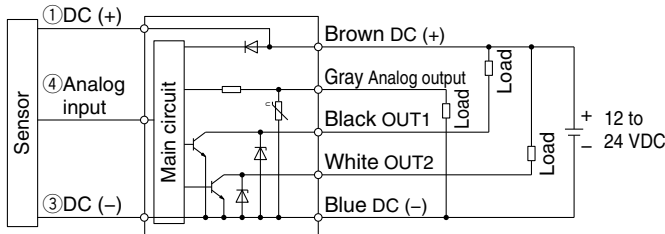

**-RT: PNP (2 outputs) + Analog voltage output**  
**-SV: PNP (2 outputs) + Analog current output**

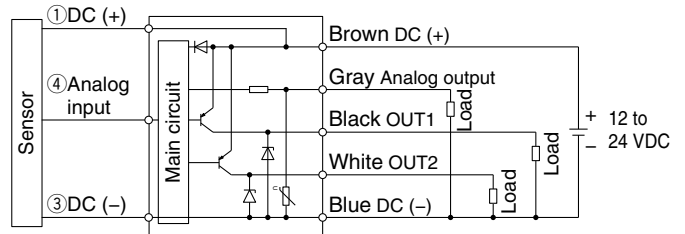

**-RT: NPN (2 outputs) + External input**  
**-SV: NPN (2 outputs) + External input**

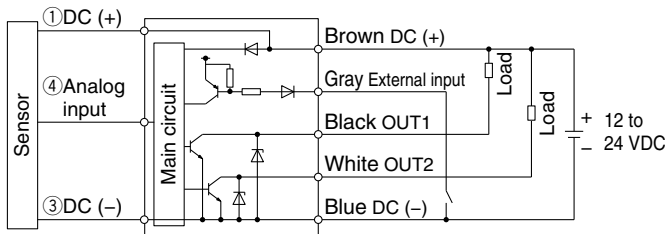

**-RT: PNP (2 outputs) + External input**  
**-SV: PNP (2 outputs) + External input**

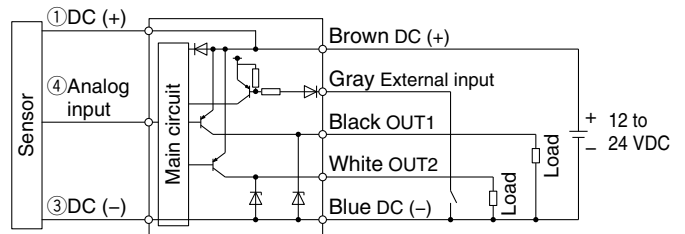

### Accumulated pulse output wiring examples

**NPN (2 outputs) type**

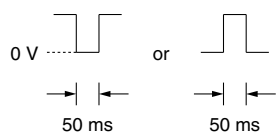
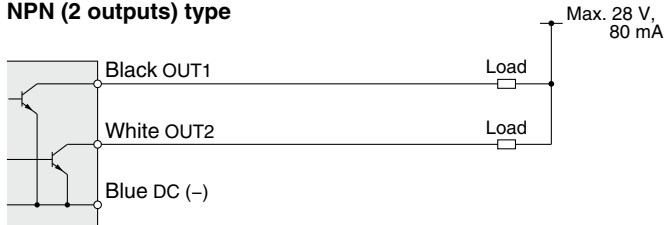

**PNP (2 outputs) type**

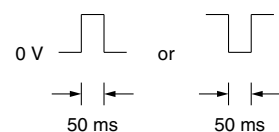
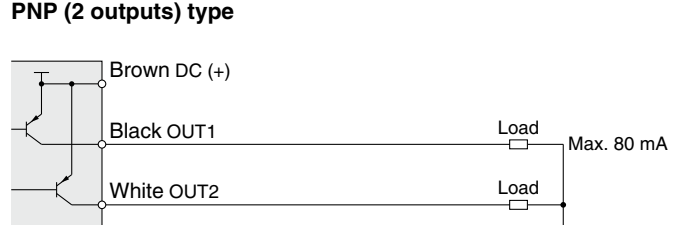



**Dimensions**

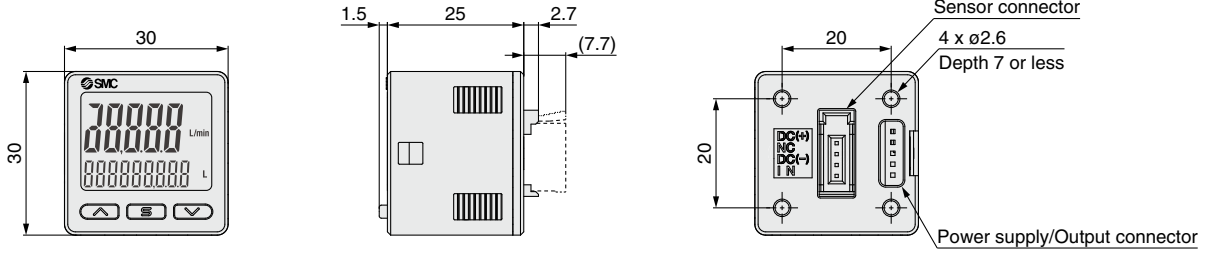

**Bracket A  
(Part no.: ZS-46-A1)**

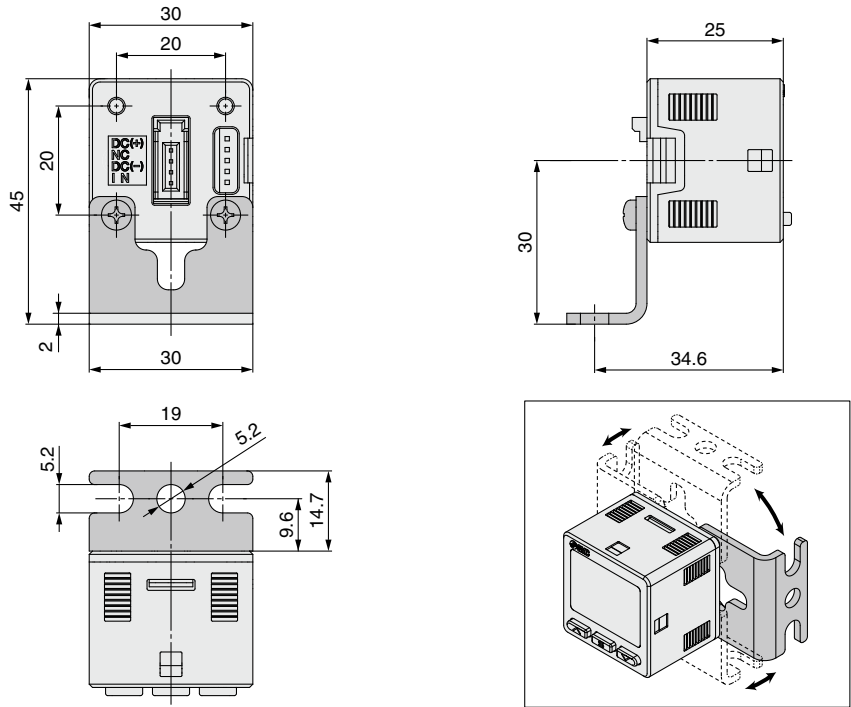

\* Bracket configuration allows for mounting in four orientations.

**Bracket B  
(Part no.: ZS-46-A2)**

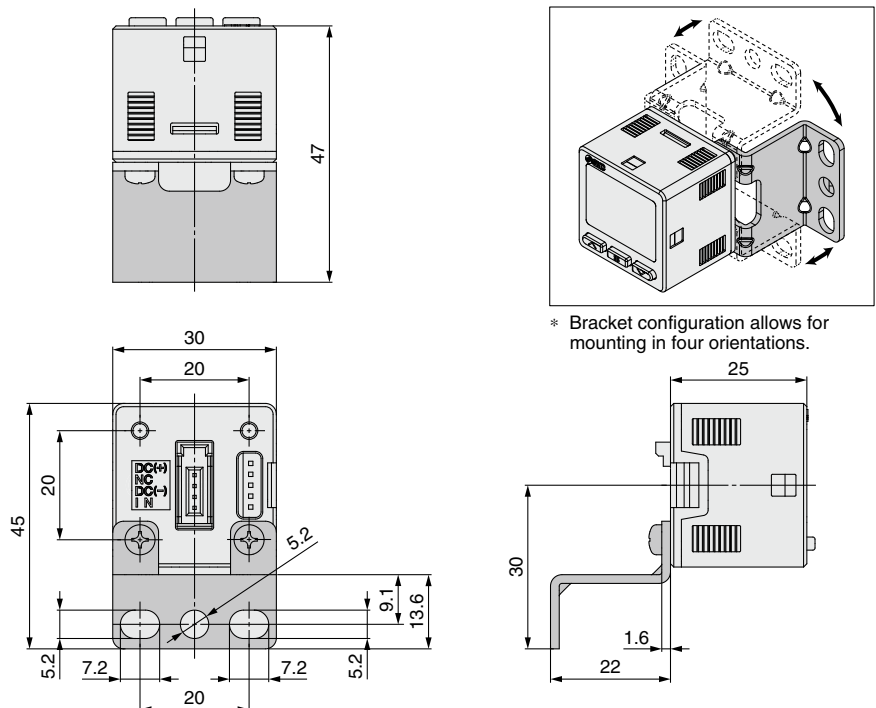

\* Bracket configuration allows for mounting in four orientations.

# PFG300 Series

## Dimensions

### Panel mount adapter (Part no.: ZS-46-B)

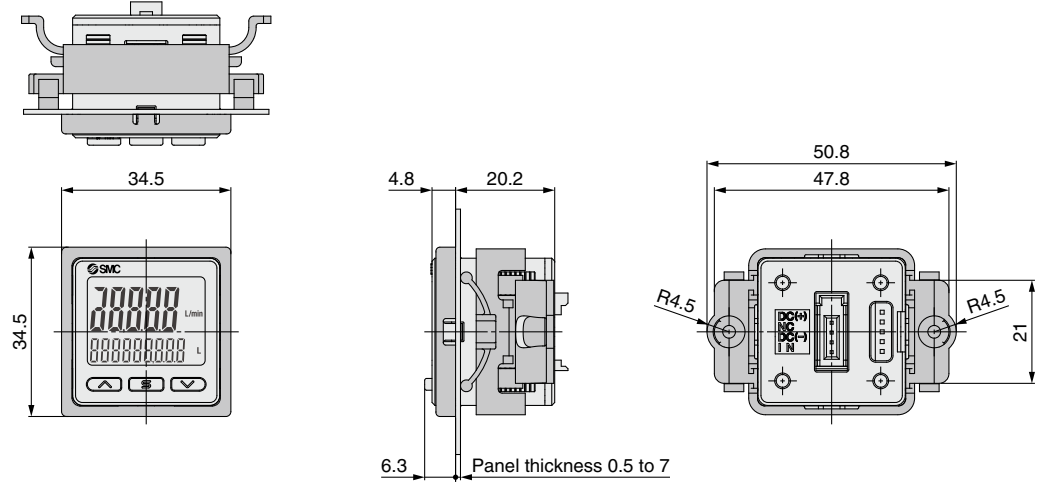

### Panel mount adapter + Front protection cover (Part no.: ZS-46-D)

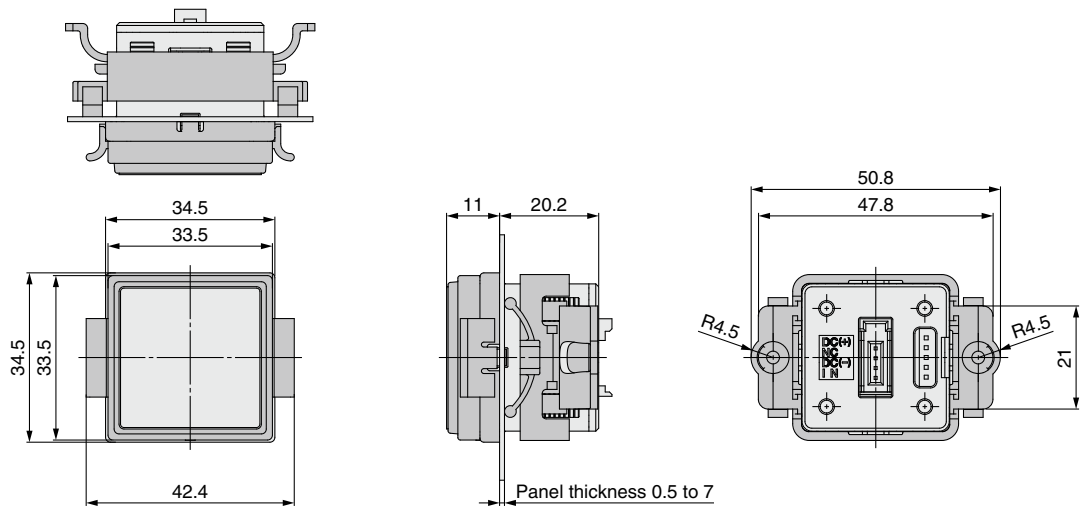

### Power supply/output connection lead wire (Part no.: ZS-46-5L)

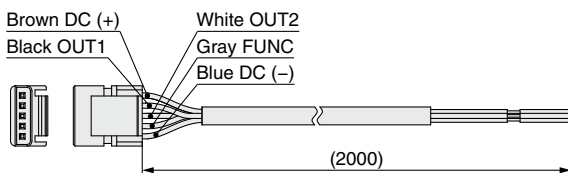

### Sensor connector (Part no.: ZS-28-CA-4)

Pin no.	Terminal
1	DC (+)
2	N.C.
3	DC (-)
4	IN*1

\*1 1 to 5 V or 4 to 20 mA

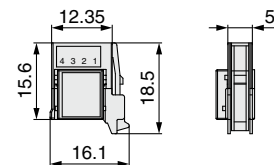

### Cable Specifications

Conductor area	0.15 mm <sup>2</sup> (AWG26)	
Insulator	O.D.	1.0 mm
	Color	Brown, Blue, Black, White, Gray (5-core)
Sheath	Finished O.D.	ø3.5

## Dimensions

### Panel fitting dimensions

#### Individual mounting

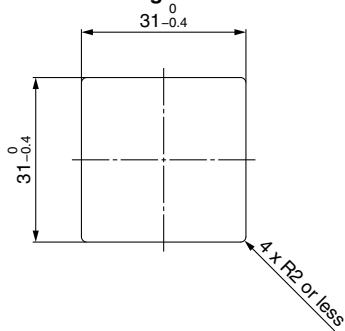

#### Multiple (2 pcs. or more) secure mounting <Horizontal>

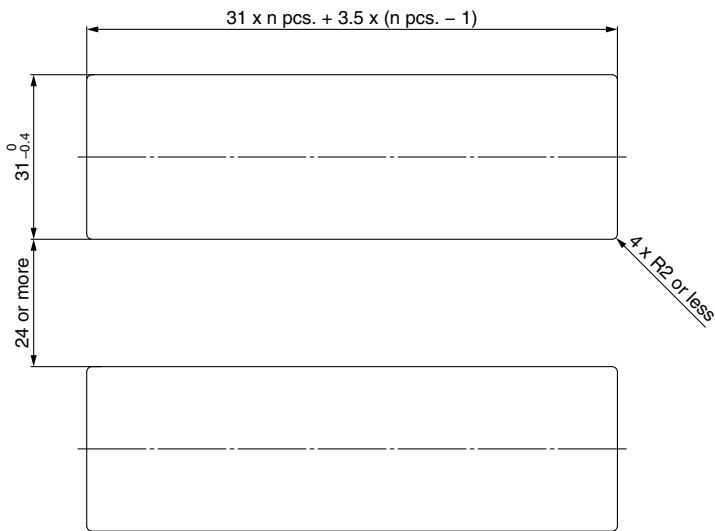

#### Panel mount example <Horizontal>

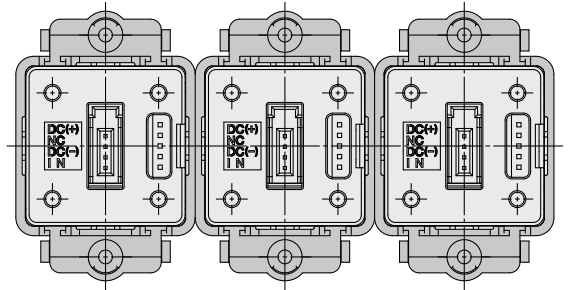

#### <Vertical>

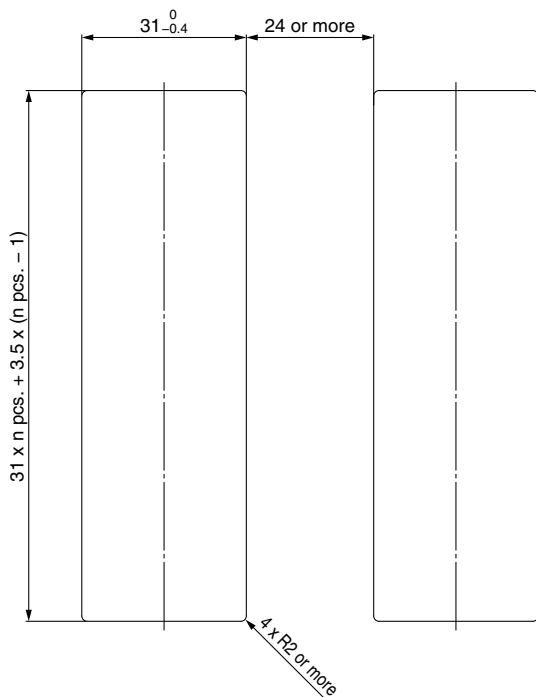

#### Panel mount example <Vertical>

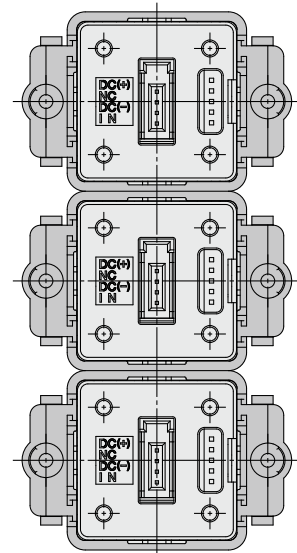

PFG300

PFG300

Function  
Details

# PFMC Series

## Function Details

### Output operation

The output operation can be selected from the following:  
Output (hysteresis mode and window comparator mode) corresponding to instantaneous flow or output (accumulated output and pulse output) corresponding to accumulated flow.

\* At the time of shipment from the factory, it is set to hysteresis mode and normal output.

### Display color

The display color can be selected for each output condition. The selection of the display color provides visual identification of abnormal values. (The display color depends on OUT1 setting.)

Green for ON, Red for OFF
Red for ON, Green for OFF
Red all the time
Green all the time

### Reference condition

The display unit can be selected from standard condition or normal condition.

Standard condition: Flow rate converted to a volume at 20°C and 1 atm (atmosphere)
Normal condition: Flow rate converted to a volume at 0°C and 1 atm (atmosphere)

### Display mode

The display mode can be selected from instantaneous flow or accumulated flow.

Instantaneous flow display
Accumulated flow display

### Response time

The response time can be selected to suit the application. (Default setting : 1 s)  
Abnormalities can be detected more quickly by setting the response time to 0.05 seconds.  
The effect of fluctuation and flickering of the display can be reduced by setting the response time to 2 seconds.

0.05 s
0.1 s
0.5 s
1 s
2 s

### Selection of display on sub screen

The display on the sub screen in measuring mode can be set.

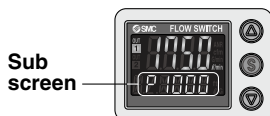

Set value display	Accumulated value display	Peak value display
Displays the set value (The set value of OUT2 cannot be displayed.) 	Displays the accumulated value (The accumulated value of OUT2 cannot be displayed.) 	Displays the peak value 
Bottom value display	Line name display	OFF
Displays the bottom value 	Displays the line name (Up to 6 alphanumeric characters can be input.) 	Displays nothing 

### Display OFF mode

This function will turn the display OFF. In this mode, decimal points flash on the main screen. If any button is pressed during this mode, the display reverts to normal for 30 seconds to allow checking of the flow, etc.

### Setting of security code

The user can select whether a security code must be entered to release the key lock. At the time of shipment from the factory, it is set such that a security code is not required.

### External input function

This function can be used only when the optional external input is present. The accumulated flow, peak value, and bottom value can be reset remotely.

**Accumulated value external reset:** A function to reset the accumulated flow value when an external input signal is applied.  
In accumulated increment mode, the accumulated value will reset to and increase from zero.  
In accumulated decrement mode, the accumulated value will reset to and decrease from the set value.

\* When the accumulated value is stored to memory, every time the accumulated value external reset is activated, the memory (EEPROM) will be accessed. Take into consideration that the maximum number of times the memory can be accessed is 1 million times. The total number of external inputs and the accumulated value memorizing time interval should not exceed 1 million times.

**Peak/Bottom value reset:** Peak and bottom value are reset.

### Forced output function

The output is turned on/off in a fixed state when starting the system or during maintenance. This enables the confirmation of wiring and prevents system errors due to unexpected output.

For the analog output type, when ON the output will be 5 V or 20 mA, and when OFF, it will be 1 V or 4 mA.

\* Also, an increase or decrease of the flow and temperature will not change the on/off status of the output while the forced output function is activated.

### Accumulated value hold

The accumulated value is not cleared even when the power supply is turned off.

The accumulated value is memorized every 2 or 5 minutes during measurement and continues from the last memorized value when the power supply is turned on again.

The life time of the memory device is 1 million access times. Take this into consideration before using this function.

### Peak/Bottom value display

The maximum (minimum) flow rate is detected and updated from when the power supply is turned on. In peak (bottom) value display mode, this maximum (minimum) flow rate is displayed.

### Keylock function

Prevents operation errors such as accidentally changing setting values

■ **Analog output free range function**

This function allows a flow that generates an output of 5 V or 20 mA to be changed. The value can be changed between 10% of the maximum value of the rated flow and the maximum value of the display range.

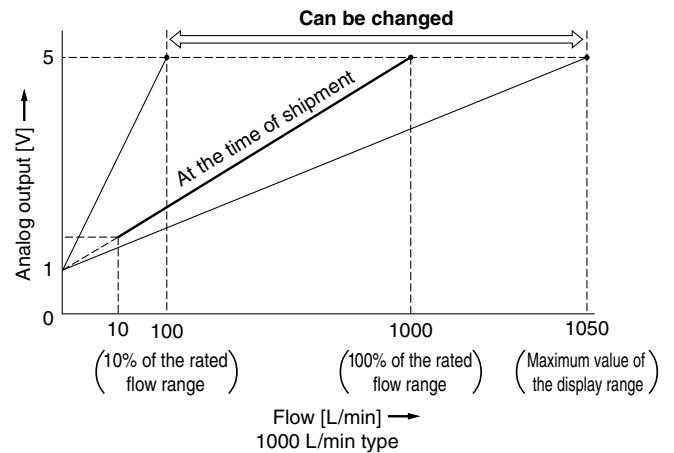

■ **Error display function**

When an error or abnormality arises, the location and contents are displayed.

Display	Description	Contents	Action	
Er1	OUT1 over current error	A load current of 80 mA or more is applied to the switch output (OUT1).	Eliminate the cause of the over current by turning off the power supply and then turning it on again.	
Er2	OUT2 over current error	Load current of 80 mA or more is applied to the switch output (OUT2).		
HHH	Instantaneous flow error	The flow rate exceeds the maximum value of the display range.	Decrease the flow rate.	
LLL	Reverse flow error	There is a reverse flow equivalent to -5% or more.	Change the flow to the correct direction.	
999999999 (Alternately displays [999] and [999999].)	PFMC7501 PFMC7102 PFMC7202	Accumulated flow error	The flow rate exceeds the accumulated flow rate range.	Clear the accumulated flow rate.
Er0	System error	Displayed if an internal error has occurred.	Turn the power off and then on again.	
Er4				
Er6				
Er8				

If the error cannot be solved after the above instructions are performed, please contact SMC for investigation.

# PF300 Series

## Function Details

### Output operation

The output operation can be selected from the following:  
Output (hysteresis mode and window comparator mode) corresponding to instantaneous flow or output (accumulated output and pulse output) corresponding to accumulated flow.

(Default setting: Hysteresis mode, Normal output)

### Simple setting mode

Only the set values for instantaneous flow and accumulated flow can be changed. Output mode, output type, display color, and accumulate pulse output cannot be changed.

### Display color

The display color can be selected for each output condition. The selection of the display color provides visual identification of abnormal values.

Green for ON, Red for OFF
Red for ON, Green for OFF
Red all the time
Green all the time

### Delay time setting

The time from when the instantaneous flow reaches the set value to when the switch output operates can be set. Setting the delay time can prevent the switch output from chattering.

(Default setting: 0 s)

0.00 s
0.05 to 0.1 s (increment of 0.01 s)
0.1 to 1.0 s (increment of 0.1 s)
1 to 10 s (increment of 1 s)
20 s
30 s
40 s
50 s
60 s

### Digital filter setting

The time for the digital filter can be set to the sensor input. Setting the digital filter can reduce chattering of the switch output and flickering of the analog output and the display.

The response time indicates when the set value is 90% in relation to the step input.

(Default setting: 0 s)

0.00 s
0.05 to 0.1 s (increment of 0.01 s)
0.1 to 1.0 s (increment of 0.1 s)
1 to 10 s (increment of 1 s)
20 s
30 s

### FUNC output switching function

Analog output, external input, or copy function can be selected.

(Default setting: Analog output)

### Selectable analog output function

1 to 5 V or 0 to 10 V can be selected for the analog voltage output type.

(Default setting: 1 to 5 V)

### External input function

The accumulated flow, peak value, and bottom value can be reset remotely.

**Accumulated value external reset:** A function to reset the accumulated flow value when an external input signal is applied.

In accumulated increment mode, the accumulated value will reset to and increase from zero.

In accumulated decrement mode, the accumulated value will reset to and decrease from the set value.

\* When the accumulated value is stored to memory, every time the accumulated value external reset is activated, the memory will be accessed. Take into consideration that the maximum number of times the memory can be accessed is 1.5 million times. The total number of external inputs and the accumulated value memorizing time interval should not exceed 1.5 million times.

**Peak/Bottom value reset:** Peak and bottom value are reset.

### Forced output function

The output is turned on/off in a fixed state when starting the system or during maintenance. This enables the confirmation of wiring and prevents system errors due to unexpected output.

For the analog output type: When ON, the output will be 5 V (or 10 V when 0 to 10 V is selected) or 20 mA, and when OFF, 1 V (or 0 V when 0 to 10 V is selected) or 4 mA.

\* Also, an increase or decrease of the flow will not change the on/off status of the output while the forced output function is activated.

### Accumulated value hold

The accumulated value is not cleared even when the power supply is turned off. The accumulated value is memorized every 2 or 5 minutes during measurement and continues from the last memorized value when the power supply is turned on again.

The maximum writable limit of the memory device is 1.5 million times, which should be taken into consideration.

### Peak/Bottom value display

The maximum (minimum) flow rate is detected and updated from when the power supply is turned on. In peak (bottom) value display mode, this maximum (minimum) flow rate is displayed.

### Setting of security code

The user can select whether a security code must be entered to release the key lock. At the time of shipment from the factory, it is set such that a security code is not required.

### Keylock function

Prevents operation errors such as accidentally changing setting values

### Reset to the default settings

The product can be returned to its factory default settings.

### Display with zero cut-off setting

When the flow is close to 0 L/min, the product will round the value down and zero will be displayed. A flow value may be displayed even when the flow rate is 0 L/min due to high pressure or depending on the installation. The zero-cut function will force the display to zero. The range to display zero can be changed.

## ■ Selection of display on sub screen

The display on the sub screen in measuring mode can be set.



Set value display	Accumulated value display	Peak value display
Displays the set value 	Displays the accumulated value 	Displays the peak value 
Bottom value display	Line name display	OFF
Displays the bottom value 	Displays the line name (Up to 5 alphanumeric characters can be input.) 	Displays nothing 

## ■ Analog output free range function

This function allows a flow that generates an output of 5 V (or 10 V when 0 to 10 V is selected) or 20 mA to be changed. The value can be changed between 10% of the maximum value of the rated flow and the maximum value of the display range.

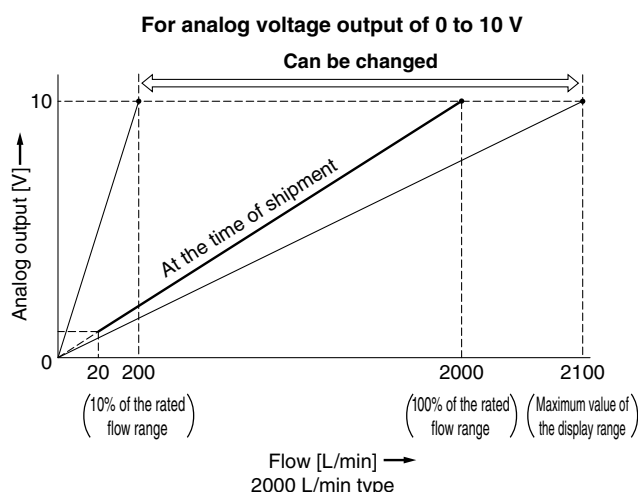
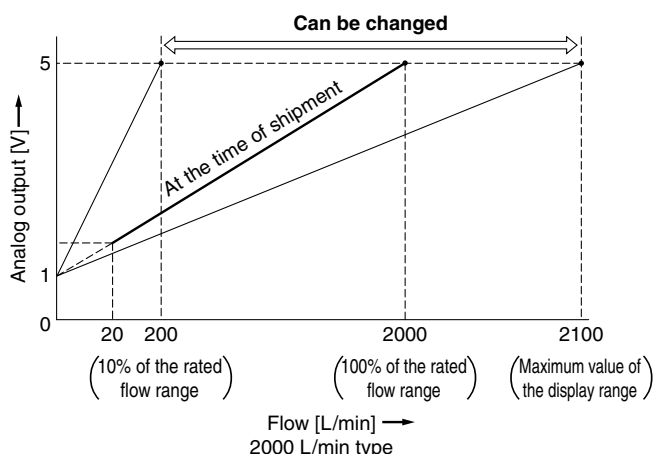

## ■ Error display function

When an error or abnormality arises, the location and contents are displayed.

Display	Description	Contents	Action
Er1 Er2	OUT over current error	A load current of 80 mA or more is applied to the switch output (OUT).	Eliminate the cause of the over current by turning off the power supply and then turning it on again.
HHH	Instantaneous flow error	The flow rate exceeds the maximum value of the display range.	Decrease the flow rate.
LLL	Reverse flow error	There is a reverse flow equivalent to -5% or more.	Change the flow to the correct direction.
999999 x 10 <sup>6</sup>	Accumulated flow error	The flow rate exceeds the accumulated flow rate range.	Clear the accumulated flow rate.
Er0 Er4 Er6 Er7 Er8 Er14 Er40	System error	Displayed if an internal error has occurred.	Turn the power off and then on again.
Er13	Copy error	The copy function does not operate properly.	After clearing the error by pressing the  and  buttons simultaneously for a minimum of 1 second, check the wiring and the model, and then attempt to copy again.

If the error cannot be solved after the above instructions are performed, please contact SMC for investigation.

# PF300 Series

## ■ Copy function

The settings of the master monitor can be copied to the slave monitors, reducing setting labor and minimizing the risk of setting mistakes.

**The set value can be copied to up to 10 flow monitors simultaneously.**

**(Maximum transmission distance: 4 m)**

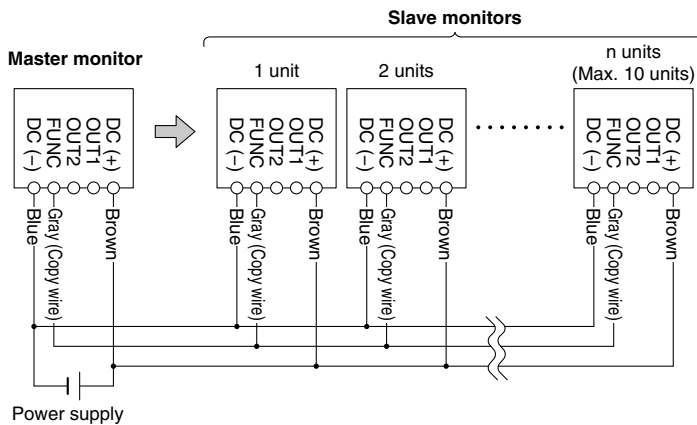
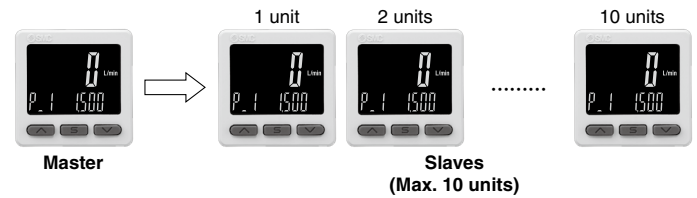

- 1) Wire as shown in the figure on the left.
- 2) Select the slave monitor which is to be the master, and change it into a master using the buttons. (In the default setting, all flow monitors are set as slaves.)
- 3) Press the **S** button on the master monitor to start copying.

## ■ Selection of power-saving mode

The power-saving mode can be selected.

With this function, if no buttons are pressed for 30 s, it shifts to power-saving mode.

At the time of shipment from the factory, the product is set to the normal mode (the power-saving mode is turned off).

(During power-saving mode, [ECo] will flash in the sub screen and the operation light will be ON (only when the switch is ON).)

\* There may be a difference in the displayed value on the connected flow switch and the flow monitor. When the flow monitor display is being used, it is recommended to set the flow switch display to OFF mode.



## Safety Instructions

These safety instructions are intended to prevent hazardous situations and/or equipment damage. These instructions indicate the level of potential hazard with the labels of “**Caution**,” “**Warning**” or “**Danger**.” They are all important notes for safety and must be followed in addition to International Standards (ISO/IEC)\*1), and other safety regulations.

 **Caution:** **Caution** indicates a hazard with a low level of risk which, if not avoided, could result in minor or moderate injury.

 **Warning:** **Warning** indicates a hazard with a medium level of risk which, if not avoided, could result in death or serious injury.

 **Danger :** **Danger** indicates a hazard with a high level of risk which, if not avoided, will result in death or serious injury.

\*1) ISO 4414: Pneumatic fluid power – General rules relating to systems.  
ISO 4413: Hydraulic fluid power – General rules relating to systems.  
IEC 60204-1: Safety of machinery – Electrical equipment of machines.  
(Part 1: General requirements)  
ISO 10218-1: Manipulating industrial robots – Safety.  
etc.

### Warning

#### 1. The compatibility of the product is the responsibility of the person who designs the equipment or decides its specifications.

Since the product specified here is used under various operating conditions, its compatibility with specific equipment must be decided by the person who designs the equipment or decides its specifications based on necessary analysis and test results. The expected performance and safety assurance of the equipment will be the responsibility of the person who has determined its compatibility with the product. This person should also continuously review all specifications of the product referring to its latest catalog information, with a view to giving due consideration to any possibility of equipment failure when configuring the equipment.

#### 2. Only personnel with appropriate training should operate machinery and equipment.

The product specified here may become unsafe if handled incorrectly. The assembly, operation and maintenance of machines or equipment including our products must be performed by an operator who is appropriately trained and experienced.

#### 3. Do not service or attempt to remove product and machinery/equipment until safety is confirmed.

1. The inspection and maintenance of machinery/equipment should only be performed after measures to prevent falling or runaway of the driven objects have been confirmed.
2. When the product is to be removed, confirm that the safety measures as mentioned above are implemented and the power from any appropriate source is cut, and read and understand the specific product precautions of all relevant products carefully.
3. Before machinery/equipment is restarted, take measures to prevent unexpected operation and malfunction.

#### 4. Contact SMC beforehand and take special consideration of safety measures if the product is to be used in any of the following conditions.

1. Conditions and environments outside of the given specifications, or use outdoors or in a place exposed to direct sunlight.
2. Installation on equipment in conjunction with atomic energy, railways, air navigation, space, shipping, vehicles, military, medical treatment, combustion and recreation, or equipment in contact with food and beverages, emergency stop circuits, clutch and brake circuits in press applications, safety equipment or other applications unsuitable for the standard specifications described in the product catalog.
3. An application which could have negative effects on people, property, or animals requiring special safety analysis.
4. Use in an interlock circuit, which requires the provision of double interlock for possible failure by using a mechanical protective function, and periodical checks to confirm proper operation.

### Caution

#### 1. The product is provided for use in manufacturing industries.

The product herein described is basically provided for peaceful use in manufacturing industries.  
If considering using the product in other industries, consult SMC beforehand and exchange specifications or a contract if necessary.  
If anything is unclear, contact your nearest sales branch.

### Limited warranty and Disclaimer/ Compliance Requirements

The product used is subject to the following “Limited warranty and Disclaimer” and “Compliance Requirements”.

Read and accept them before using the product.

#### Limited warranty and Disclaimer

1. The warranty period of the product is 1 year in service or 1.5 years after the product is delivered, whichever is first.\*2)  
Also, the product may have specified durability, running distance or replacement parts. Please consult your nearest sales branch.
2. For any failure or damage reported within the warranty period which is clearly our responsibility, a replacement product or necessary parts will be provided.  
This limited warranty applies only to our product independently, and not to any other damage incurred due to the failure of the product.
3. Prior to using SMC products, please read and understand the warranty terms and disclaimers noted in the specified catalog for the particular products.

##### \*2) Vacuum pads are excluded from this 1 year warranty.

A vacuum pad is a consumable part, so it is warranted for a year after it is delivered.  
Also, even within the warranty period, the wear of a product due to the use of the vacuum pad or failure due to the deterioration of rubber material are not covered by the limited warranty.

#### Compliance Requirements

1. The use of SMC products with production equipment for the manufacture of weapons of mass destruction (WMD) or any other weapon is strictly prohibited.
2. The exports of SMC products or technology from one country to another are governed by the relevant security laws and regulations of the countries involved in the transaction. Prior to the shipment of a SMC product to another country, assure that all local rules governing that export are known and followed.

### Caution

#### SMC products are not intended for use as instruments for legal metrology.

Measurement instruments that SMC manufactures or sells have not been qualified by type approval tests relevant to the metrology (measurement) laws of each country. Therefore, SMC products cannot be used for business or certification ordained by the metrology (measurement) laws of each country.

#### Revision History

**Edition B** \* The digital flow monitor PFG300 series has been added.  
\* Number of pages has been increased from 16 to 28.

VU

## Safety Instructions

Be sure to read the “Handling Precautions for SMC Products” (M-E03-3) and “Operation Manual” before use.