

Step Motor Controller



- Parallel I/O
- Step motor (Servo/24 VDC)
- Number of step data: 64 points

Step data input type

JXC51/61 Series



- Step motor (Servo/24 VDC)
- Number of step data: 64 points

New A controller with STO sub-function has been added.



- Product certification obtained by a third party (EN 61508 SIL 3, EN 62061 SIL CL 3, EN ISO 13849-1 Cat. 3 PL e)
- EN 61800-5-2 STO (Safe Torque Off) function

IO-Link
JXCLF Series



EtherCAT
direct input type

JXCE1 Series

Applicable network



EtherNet/IP™
direct input type

JXC91 Series

Applicable network



PROFINET
direct input type

JXCP1 Series

Applicable network



DeviceNet®
direct input type

JXCD1 Series

Applicable network



IO-Link
direct input type

JXCL1 Series

Applicable network



CC-Link
direct input type

JXCM1 Series

Applicable network



JXC Series



CAT.ES100-141B



Simple setting allows for immediate use!

“Easy Mode” for simple setting

For immediate use, select “Easy Mode.”

JXC51/61

<When a PC is used> Controller setting software

- Step data setting, test drive, jogging, and move for the constant rate can be set and operated on one screen.

Setting of jog and speed of the constant rate

Jogging

Start testing

Step data setting

Move for the constant rate

No.	Move M	Speed	Position	PushInFr	PushInSp	In Pos
0	Absolute	100	5.00	0	0	1.00
1	Absolute	100	10.00	0	0	1.00
2	Absolute	100	20.00	0	0	1.00
3	Absolute	200	30.00	0	0	1.00
4	Absolute	200	40.00	0	0	1.00
5	Absolute	300	50.00	0	0	1.00
6	Absolute	300	60.00	0	0	1.00
7	Absolute	400	70.00	0	0	1.00
8	Absolute	400	80.00	0	0	1.00
9	Absolute	500	90.00	0	0	1.00

<When a TB (teaching box) is used>

- The simple screen without scrolling promotes ease of setting and operation.
- Choose an icon from the first screen to select a function.
- Set the step data and check the monitor on the second screen.



Example of setting the step data

1st screen

2nd screen

Step No. 0
Posn 123.45 mm
Speed 100 mm/s

After entering the values, they can be registered by pressing “SET.”

Example of checking the operation status

1st screen

2nd screen

Monitor Axis 1
Step No. 1
Posn 12.34 mm
Speed 10 mm/s

The operation status can be checked.

Teaching box screen

- Data can be set by inputting only the position and speed. (Other conditions are preset.)

Step	Axis 1
Step No.	0
Posn	50.00 mm
Speed	200 mm/s



Step	Axis 1
Step No.	1
Posn	80.00 mm
Speed	100 mm/s

⊙ “Normal Mode” for detailed setting

Select “Normal Mode” when detailed setting is required.

- Step data can be set in detail.
- Parameters can be set.
- Signals and terminal status can be monitored.
- JOG and constant rate movement, return to origin, test drive, and testing of forced output can be performed.

<When a PC is used> Controller setting software

- Step data setting, parameter setting, monitoring, teaching, etc., are displayed in different windows.

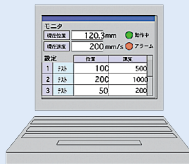

Step data setting window

No.	Move M	Speed	Position	Accel	Decel	Pushing
		mm/s	mm	mm/s ²	mm/s ²	Z
0	Absolute	100	5.00	2000	2000	
1	Absolute	100	10.00	2000	2000	
2	Absolute	100	20.00	2000	2000	
3	Absolute	200	20.00	2000	2000	
4	Absolute	200	40.00	2000	2000	
5	Absolute	300	50.00	2000	2000	
6	Absolute	300	60.00	2000	2000	
7	Absolute	400	70.00	2000	2000	
8	Absolute	400	80.00	2000	2000	
9	Absolute	500	90.00	2000	2000	
10	Absolute	500	100.00	2000	2000	

Parameter setting window

Monitoring window

Teaching window

<When a TB (teaching box) is used>

- Multiple step data can be stored in the teaching box and transferred to the controller.
- Continuous test drive by up to 5 step data

Teaching box screen

- Each function (step data setting, test drive, monitoring, etc.) can be selected from the main menu.

Main menu screen

- Menu
- Axis 1
- Step data
- Parameter
- Test

Step data setting screen

- Step
- Axis 1
- Step No. 0
- Movement MOD

Test screen

- Test DRV
- Axis 1
- Step No. 1
- Posn 123.45 mm
- Stop

Monitoring screen

- Out mon
- Axis 1
- BUSY[]
- SVRE[●]
- SETON[]

The actuator and controller are provided as a set. (They can be ordered separately as well.)

Confirm that the combination of the controller and actuator is correct.

<Check the following before use.>

- ① Check the actuator label for the model number. This number should match that of the controller.
- ② Check that the Parallel I/O configuration matches (NPN or PNP).

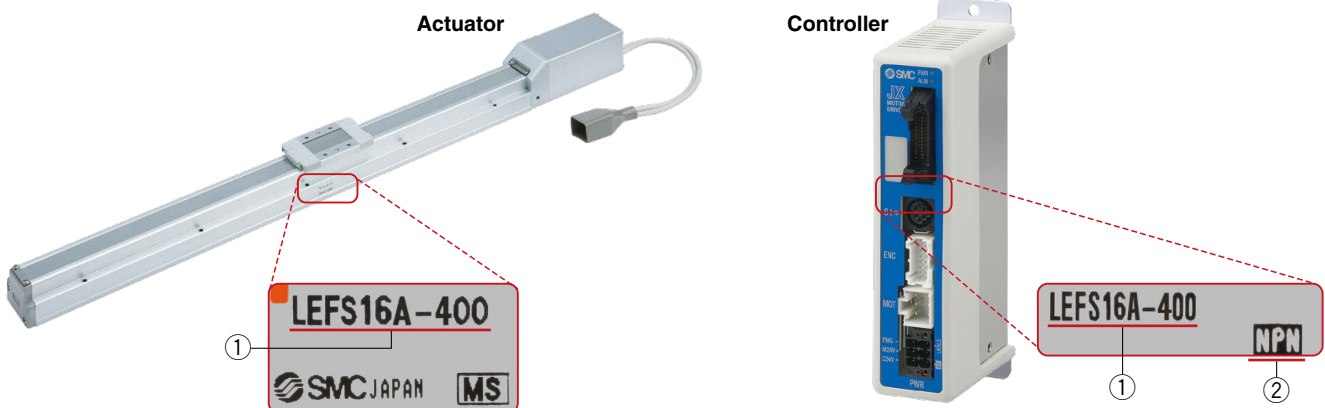

Fieldbus Network

EtherCAT/EtherNet/IP™/PROFINET/ DeviceNet®/IO-Link/CC-Link Direct Input Type Step Motor Controller/JXC□ Series p. 18



⊙ **Two types of operation command**

Step no. defined operation: Operate using the preset step data in the controller.
Numerical data defined operation: The actuator operates using values such as position and speed from the PLC.

⊙ **Numerical monitoring available**

Numerical information, such as the current speed, current position, and alarm codes, can be monitored on the PLC.

⊙ **Transition wiring of communication cables**

Two communication ports are provided.
 * For the DeviceNet® type and CC-Link type, transition wiring is possible using a branch connector.
 * 1 to 1 in the case of IO-Link

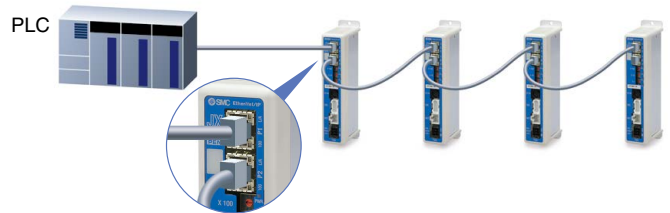

Application

Communication protocols

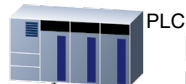

Both air and electric systems can be established under the same protocol.

Can be additionally installed in an existing network

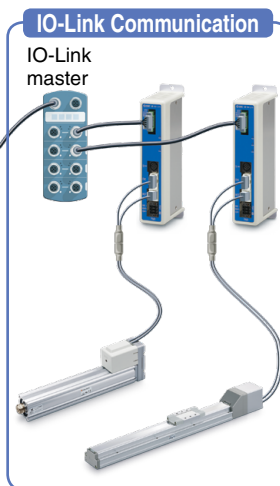
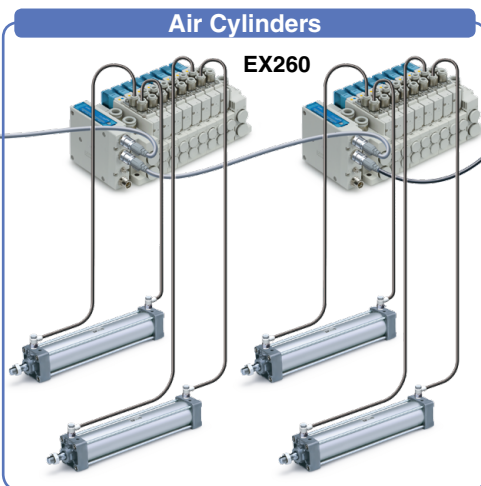
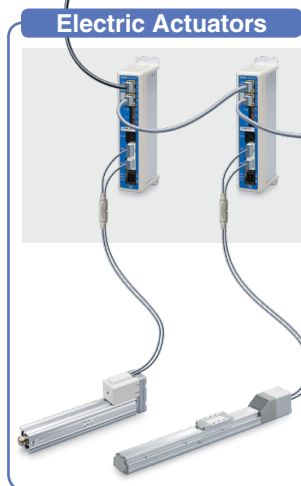

<Applicable Electric Actuators>

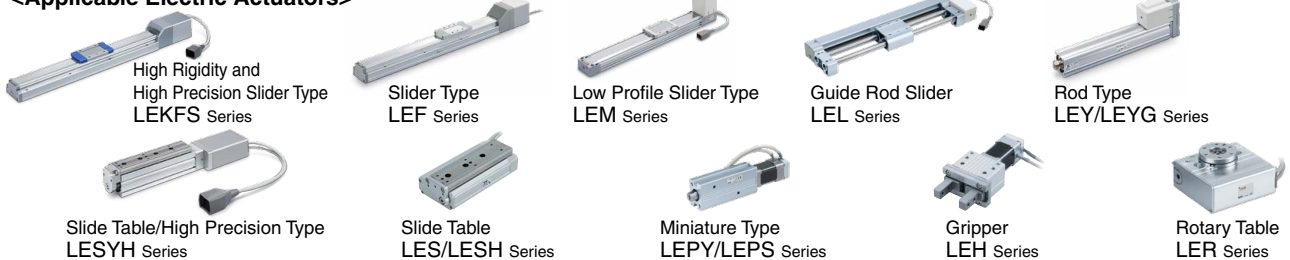

Controller with STO Sub-Function JXC□F Series

Safety function/STO, SS1-t (EN 61800-5-2)

When the STO signal is input from the safety device, after the SS1-t operation is completed, the unit shifts to the STO operation and the power supply of the motor is turned OFF.

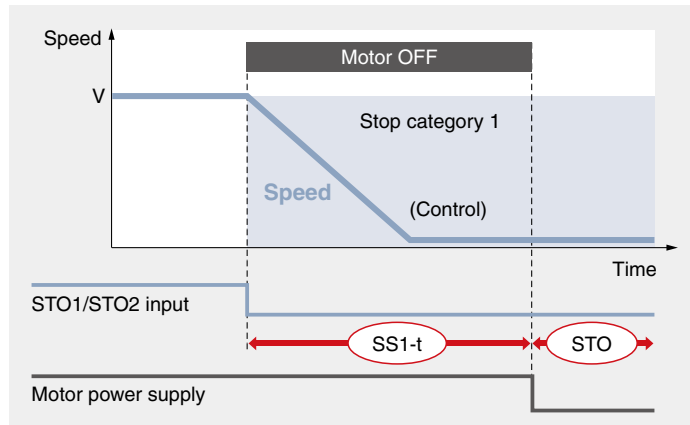

SS1-t operation: Safe Stop 1—After deceleration, a shift to the STO operation occurs.

STO operation: Safe Torque Off—The power supply of the motor is turned OFF.

External Device Connection Example

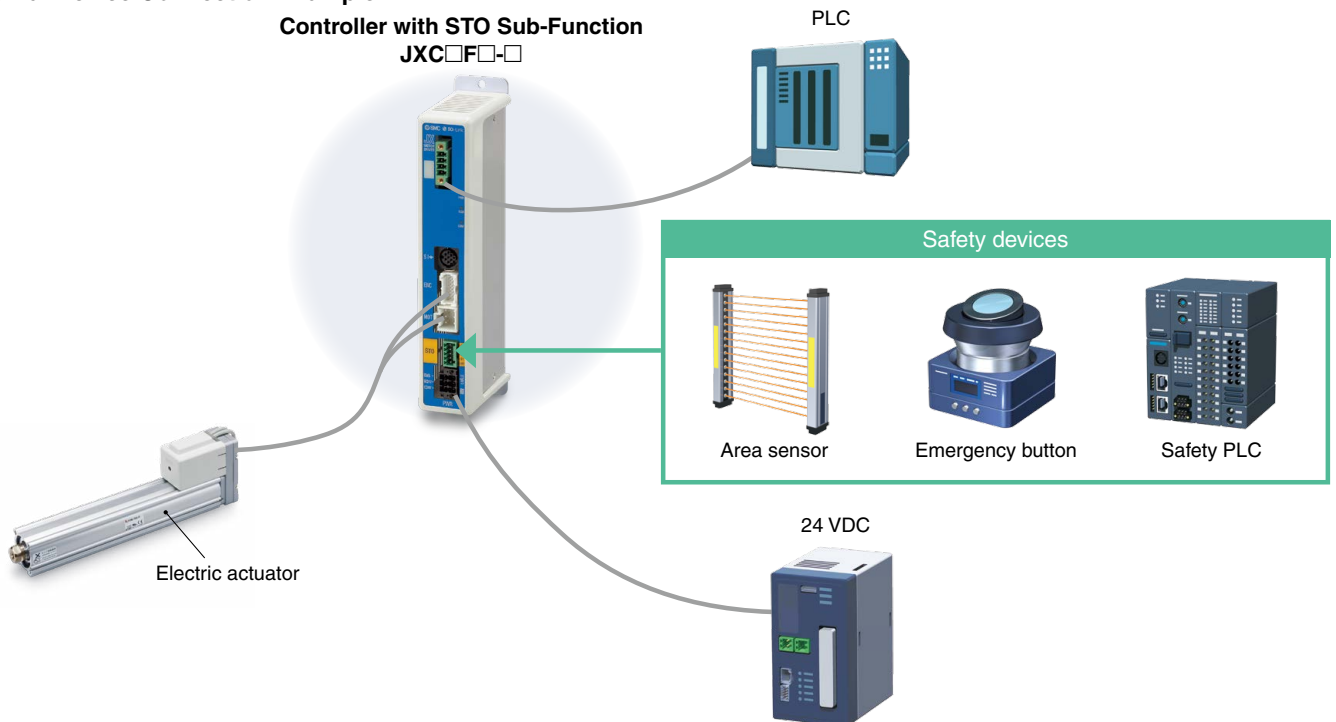

Certified by a third-party organization

Facilitates the safety designing of equipment and facilities (compliant with ISO/IEC standards)



EN 61508 SIL 3*1
 EN 62061 SIL CL 3*1
 EN ISO 13849-1 Cat. 3 PL e
 EN 61800-5-2 STO, SS1-t

SIL (Safety Integrity Level)

A safety integrity level as defined by international standard IEC 61508/62061
 There are 4 levels of safety, with the lowest being SIL 1 and the highest being SIL 4.

PL (Performance Level)

A scale used to define the capability of safety-related parts to perform a safety function as defined by international standard ISO 13849
 There are 5 levels of safety function, with the lowest being PL a and the highest being PL e.

*1 The above safety integrity level is the max. value. The achievable level varies depending on the configuration and inspection method of the component. Be sure to refer to "Safety Manual: JXC#-OMY0009" for more information.

System Construction/General Purpose I/O

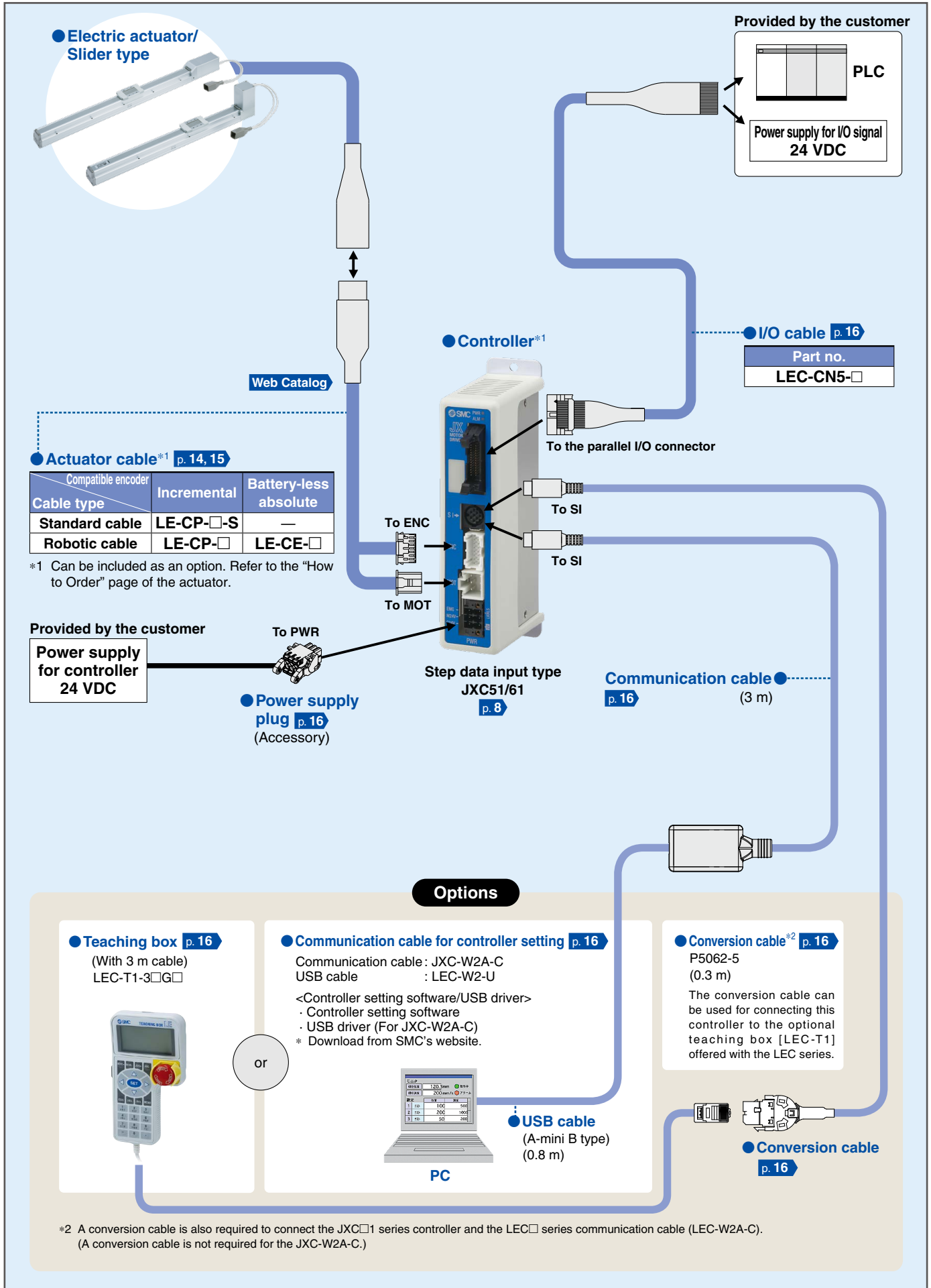

System Construction/Fieldbus Network

(EtherCAT/EtherNet/IP™/PROFINET/DeviceNet®/IO-Link/CC-Link Direct Input Type)

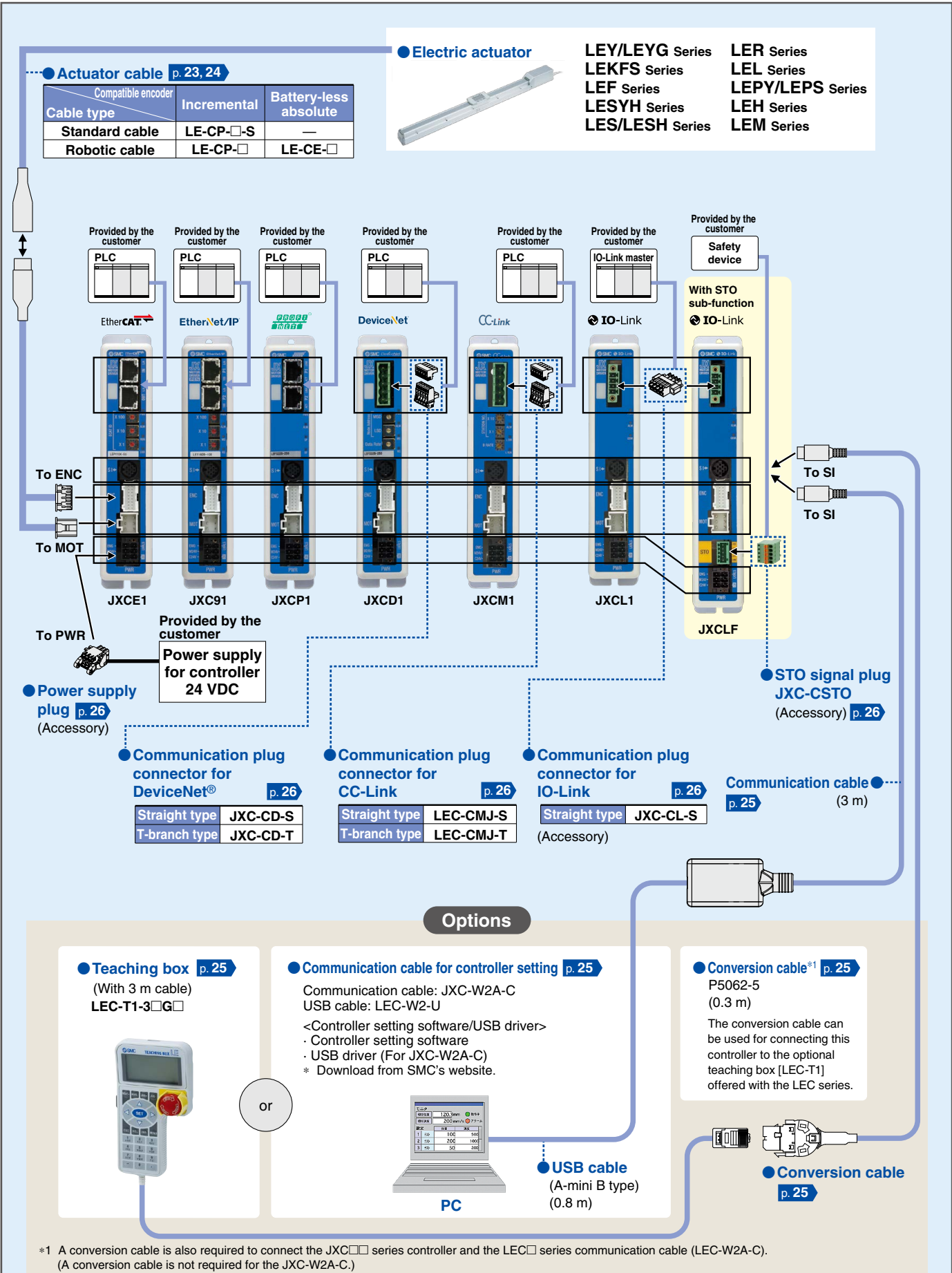

Options

Teaching box p. 25
(With 3 m cable)
LEC-T1-3□G□

Communication cable for controller setting p. 25

Communication cable: JXC-W2A-C
USB cable: LEC-W2-U

<Controller setting software/USB driver>

- Controller setting software
- USB driver (For JXC-W2A-C)

* Download from SMC's website.

OR

USB cable (A-mini B type) (0.8 m)

Conversion cable*1 p. 25
P5062-5 (0.3 m)

The conversion cable can be used for connecting this controller to the optional teaching box [LEC-T1] offered with the LEC series.

Conversion cable p. 25

*1 A conversion cable is also required to connect the JXC□□ series controller and the LEC□□ series communication cable (LEC-W2A-C). (A conversion cable is not required for the JXC-W2A-C.)

CONTENTS

Controller (Step Data Input Type) JXC51/61 Series



JXC51/61

How to Order	p. 8
Specifications	p. 8
How to Mount	p. 9
Dimensions	p. 10
Wiring Example	p. 11
Step Data Setting	p. 12
Signal Timing	p. 13
Actuator Cable	p. 14
Options: Actuator Cable	p. 15
Options	p. 16

Step Motor Controller JXCE1/91/P1/D1/L□/M1 Series

EtherCAT[®] EtherNet/IP[®] PROFINET[®] DeviceNet[®]



JXCE1

JXC91

JXCP1

JXCD1

How to Order	p. 18
Specifications	p. 19
Example of Operation Command	p. 19
Dimensions	p. 20
Actuator Cable	p. 23
Options: Actuator Cable	p. 24
Options	p. 25

IO-Link CC-Link IO-Link
With STO sub-function



JXCL1

JXCM1

JXCLF

Precautions Relating to Differences in Controller Versions	p. 27
--	-------

Controller (Step Data Input Type)

JXC51/61 Series



How to Order

JXC 5 1 7 1 -

1
 2
 3
 4

1 Parallel I/O type

5	NPN
6	PNP

2 Mounting

7	Screw mounting
8*1	DIN rail

*1 The DIN rail is not included. It must be ordered separately.

3 I/O cable length [m]

Nil	None
1	1.5
3	3
5	5

4 Actuator part number

Without cable specifications and actuator options
Example: Enter "LEFS25B-100" for the
LEFS25B-100B-R1□□.

BC	Blank controller*1
-----------	--------------------

*1 Requires dedicated software (JXC-BCW)

The controller is sold as single unit after the compatible actuator is set.

Confirm that the combination of the controller and actuator is correct.

<Check the following before use.>

- ① Check the actuator label for the model number. This number should match that of the controller.
- ② Check that the Parallel I/O configuration matches (NPN or PNP).

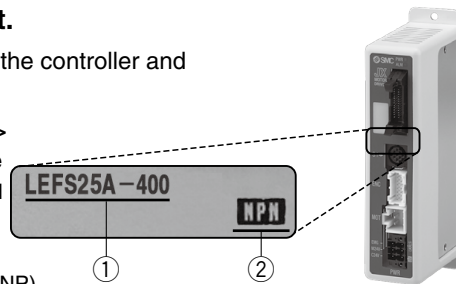

* Refer to the operation manual for using the products. Please download it via our website

Precautions for blank controllers (JXC□1□□-BC)

A blank controller is a controller to which the customer can write the data of the actuator it is to be combined and used with. Use the dedicated software (JXC-BCW) for data writing.

- Please download the dedicated software (JXC-BCW) via our website.
- Order the communication cable for controller setting (JXC-W2A-C) and USB cable (LEC-W2-U) separately to use this software.

Specifications

Model	JXC51 JXC61
Compatible motor	Step motor (Servo/24 VDC)
Power supply	Power voltage: 24 VDC ±10%
Current consumption (Controller)	100 mA or less
Compatible encoder	Incremental/Battery-less absolute
Parallel input	11 inputs (Photo-coupler isolation)
Parallel output	13 outputs (Photo-coupler isolation)
Serial communication	RS485 (Only for the LEC-T1 and JXC-W2)
Memory	EEPROM
LED indicator	PWR, ALM
Cable length [m]	Actuator cable: 20 or less
Cooling system	Natural air cooling
Operating temperature range [°C]	0 to 55°C (No freezing)
Operating humidity range [%RH]	90 or less (No condensation)
Insulation resistance [MΩ]	Between all external terminals and the case: 50 (500 VDC)
Weight [g]	150 (Screw mounting), 170 (DIN rail mounting)

JXC51/61 Series

How to Mount

a) Screw mounting (JXC□17□-□) (Installation with two M4 screws)

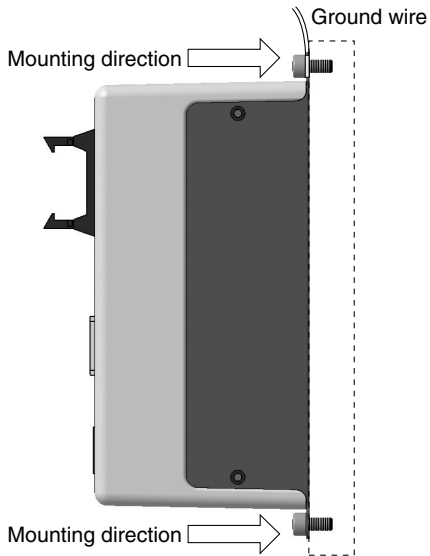

b) DIN rail mounting (JXC□18□-□) (Installation with the DIN rail)

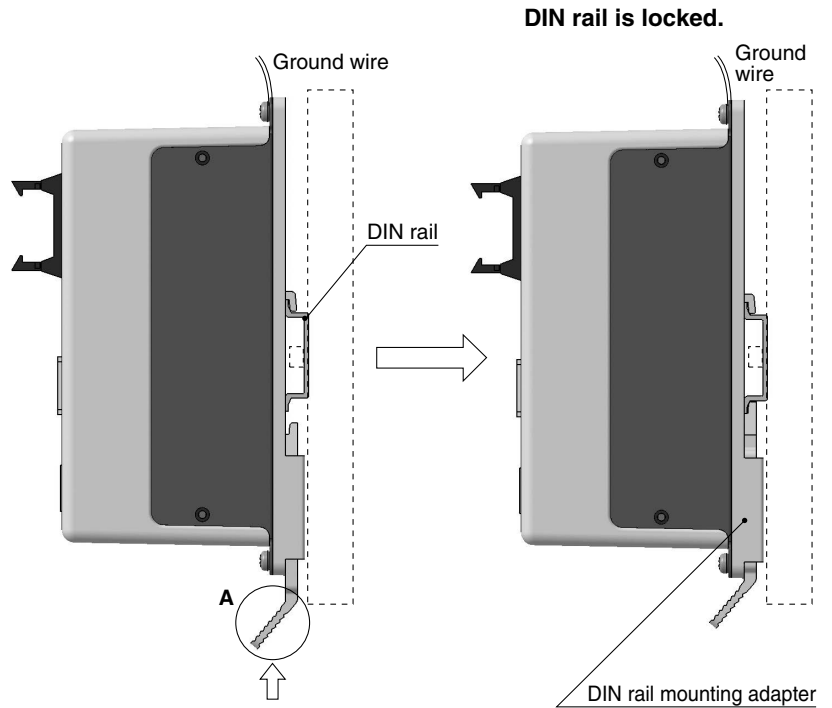

Hook the controller on the DIN rail and press the lever of section A in the arrow direction to lock it.

* When size 25 or more of the LE series are used, the space between the controllers should be 10 mm or more.

DIN rail AXT100-DR-□

* For □, enter a number from the No. line in the table below.
Refer to the dimension drawings on page 10 for the mounting dimensions.

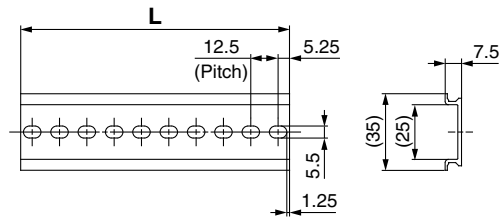

L Dimensions [mm]

No.	1	2	3	4	5	6	7	8	9	10	11	12	13	14	15	16	17	18	19	20
L	23	35.5	48	60.5	73	85.5	98	110.5	123	135.5	148	160.5	173	185.5	198	210.5	223	235.5	248	260.5
No.	21	22	23	24	25	26	27	28	29	30	31	32	33	34	35	36	37	38	39	40
L	273	285.5	298	310.5	323	335.5	348	360.5	373	385.5	398	410.5	423	435.5	448	460.5	473	485.5	498	510.5

DIN rail mounting adapter LEC-D0 (with 2 mounting screws)

This should be used when the DIN rail mounting adapter is mounted onto a screw mounting type controller afterward.

Dimensions

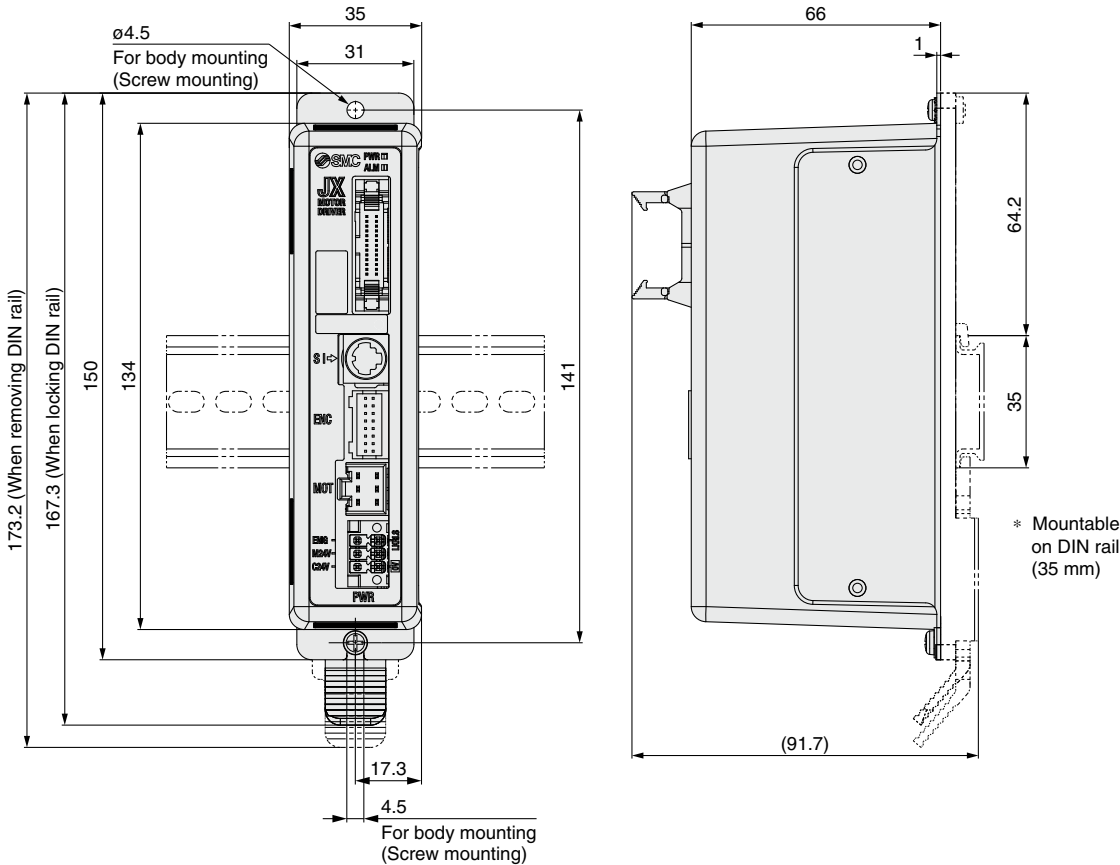

JXC51/61 Series

JXCE1/91/P1/D1/L□/M1 Series

JXC51/61 Series

Wiring Example

Parallel I/O Connector

- * When you connect a PLC to the parallel I/O connector, use the I/O cable (LEC-CN5-□).
- * The wiring changes depending on the type of parallel I/O (NPN or PNP).

Wiring diagram

JXC51□□-□ (NPN)

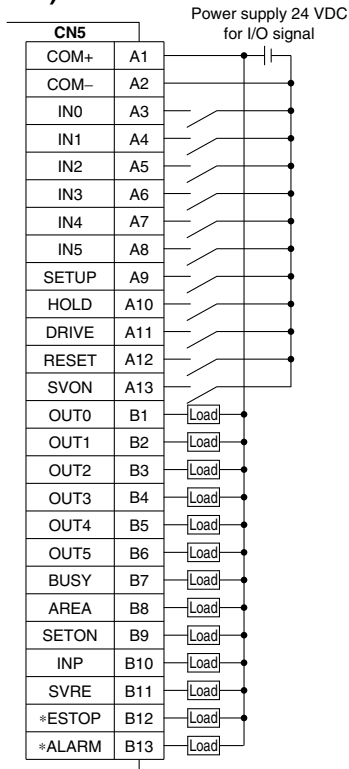

JXC61□□-□ (PNP)

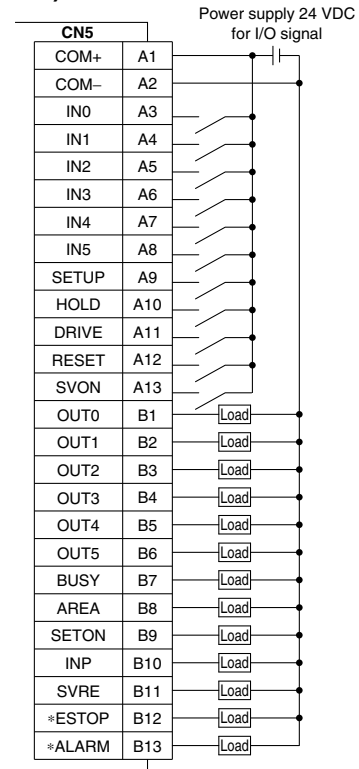

Input Signal

Name	Details
COM+	Connects the power supply 24 V for input/output signal
COM-	Connects the power supply 0 V for input/output signal
IN0 to IN5	Step data specified bit no. (Input is instructed by combining IN0 to 5.)
SETUP	Instruction to return to origin
HOLD	Temporarily stops operation
DRIVE	Instruction to drive
RESET	Resets alarm and interrupts operation
SVON	Servo ON instruction

Output Signal

Name	Details
OUT0 to OUT5	Outputs the step data no. during operation
BUSY	Outputs when the actuator is moving
AREA	Outputs within the step data area output setting range
SETON	Outputs when returning to origin
INP	Outputs when target position or target force is reached (Turns on when the positioning or pushing is completed.)
SVRE	Outputs when servo is on
ESTOP ¹	OFF when EMG stop is instructed
ALARM ¹	OFF when alarm is generated

*1 Signal of negative-logic circuit (N.C.)

Step Data Setting

1. Step data setting for positioning

In this setting, the actuator moves toward and stops at the target position.

The following diagram shows the setting items and operation. The setting items and set values for this operation are stated below.

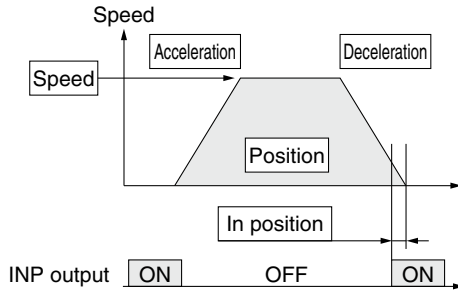

◎ : Need to be set.
○ : Need to be adjusted as required.
— : Setting is not required.

Step Data (Positioning)

Necessity	Item	Details
◎	Movement MOD	When the absolute position is required, set Absolute. When the relative position is required, set Relative.
◎	Speed	Transfer speed to the target position
◎	Position	Target position
○	Acceleration	Parameter which defines how rapidly the actuator reaches the speed set. The higher the set value, the faster it reaches the speed set.
○	Deceleration	Parameter which defines how rapidly the actuator comes to stop. The higher the set value, the quicker it stops.
◎	Pushing force	Set 0. (If values 1 to 100 are set, the operation will be changed to the pushing operation.)
—	Trigger LV	Setting is not required.
—	Pushing speed	Setting is not required.
○	Moving force	Max. torque during the positioning operation (No specific change is required.)
○	Area 1, Area 2	Condition that turns on the AREA output signal.
○	In position	Condition that turns on the INP output signal. When the actuator enters the range of [in position], the INP output signal turns on. (It is unnecessary to change this from the initial value.) When it is necessary to output the arrival signal before the operation is completed, make the value larger.

2. Step data setting for pushing

The actuator moves toward the pushing start position, and when it reaches that position, it starts pushing with the set force or less.

The following diagram shows the setting items and operation. The setting items and set values for this operation are stated below.

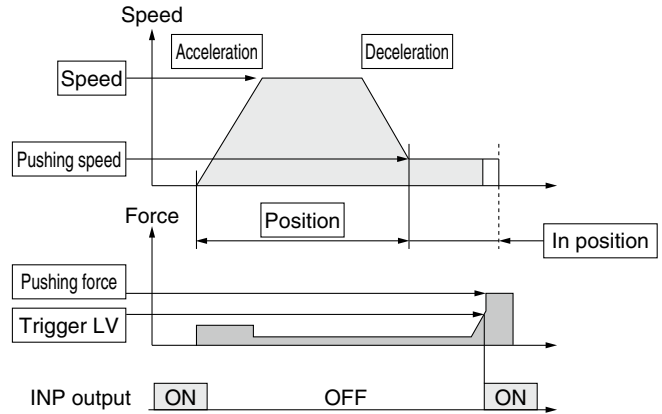

◎ : Need to be set.
○ : Need to be adjusted as required.

Step Data (Pushing)

Necessity	Item	Details
◎	Movement MOD	When the absolute position is required, set Absolute. When the relative position is required, set Relative.
◎	Speed	Transfer speed to the pushing start position
◎	Position	Pushing start position
○	Acceleration	Parameter which defines how rapidly the actuator reaches the speed set. The higher the set value, the faster it reaches the speed set.
○	Deceleration	Parameter which defines how rapidly the actuator comes to stop. The higher the set value, the quicker it stops.
◎	Pushing force	Pushing force ratio is defined. The setting range differs depending on the electric actuator type. Refer to the operation manual for the electric actuator.
◎	Trigger LV	Condition that turns on the INP output signal. The INP output signal turns on when the generated force exceeds the value. Trigger level should be the pushing force or less.
○	Pushing speed	Pushing speed during pushing. When the speed is set fast, the electric actuator and workpieces might be damaged due to the impact when they hit the end, so this set value should be smaller. Refer to the operation manual for the electric actuator.
○	Moving force	Max. torque during the positioning operation (No specific change is required.)
○	Area 1, Area 2	Condition that turns on the AREA output signal.
◎	In position	Transfer distance during pushing. If the transferred distance exceeds the setting, it stops even if it is not pushing. If the transfer distance is exceeded, the INP output signal will not turn on.

JXC51/61 Series

Signal Timing

Return to Origin

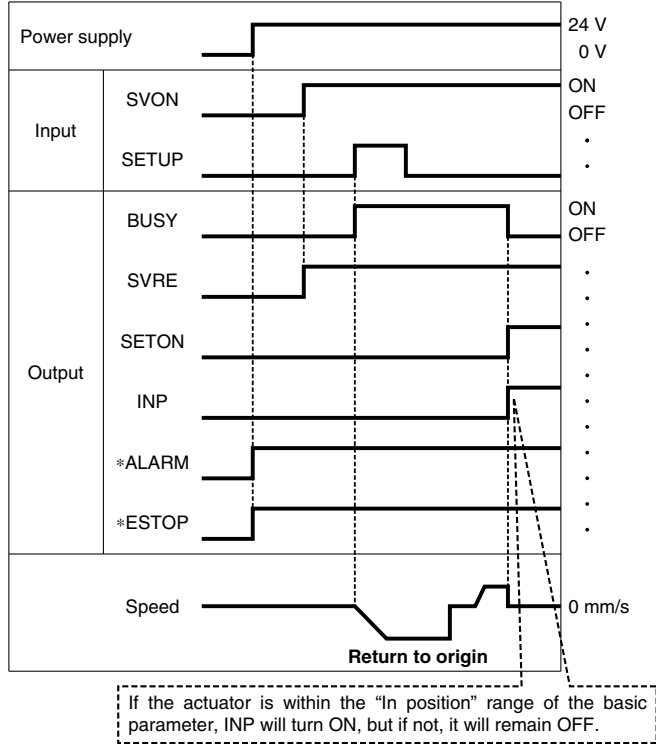

* *ALARM* and *ESTOP* are expressed as negative-logic circuits.

Positioning Operation

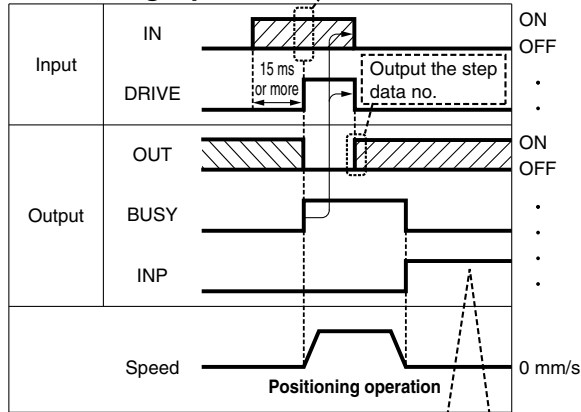

* "OUT" is output when "DRIVE" is changed from ON to OFF.
Refer to the operation manual for details on the controller for the LEM series.
(When power supply is applied, "DRIVE" or "RESET" is turned ON or *ESTOP* is turned OFF, all of the "OUT" outputs are OFF.)

HOLD

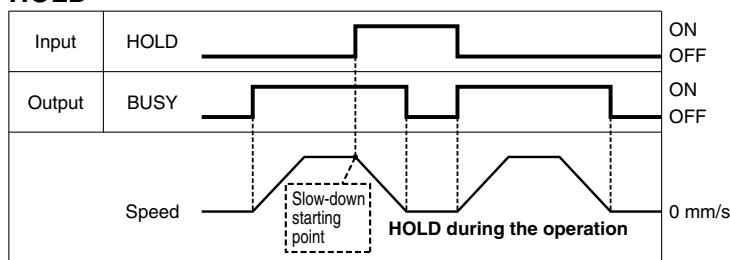

* When the actuator is within the "In position" range in the pushing operation, it does not stop even if HOLD signal is input.

Pushing Operation

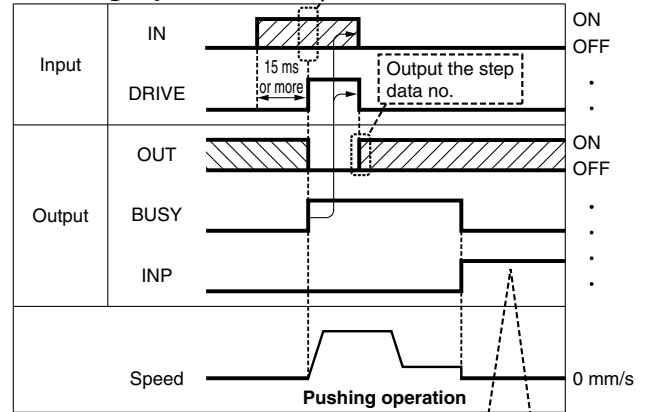

Reset

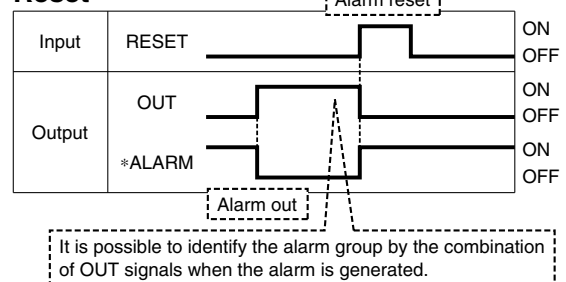

* *ALARM* is expressed as a negative-logic circuit.

Actuator Cable

[Robotic cable, standard cable for step motor (Servo/24 VDC)]

LE-CP-1-□

Cable length (L) [m]

1	1.5
3	3
5	5
8	8*1
A	10*1
B	15*1
C	20*1

*1 Produced upon receipt of order (Robotic cable only)

Cable type

Nil	Robotic cable (Flexible cable)
S	Standard cable

Weight

Product no.	Weight [g]	Note
LE-CP-1-S	190	Standard cable
LE-CP-3-S	280	
LE-CP-5-S	460	
LE-CP-1	140	Robotic cable
LE-CP-3	260	
LE-CP-5	420	
LE-CP-8	790	
LE-CP-A	980	
LE-CP-B	1460	
LE-CP-C	1940	

LE-CP-¹/₅/Cable length: 1.5 m, 3 m, 5 m

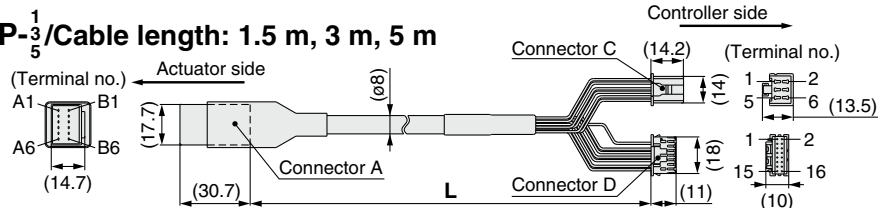

LE-CP-^{8 B}/_{A C}/Cable length: 8 m, 10 m, 15 m, 20 m
(*1 Produced upon receipt of order)

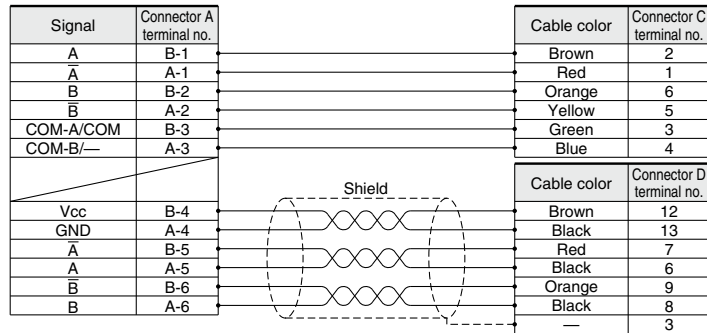
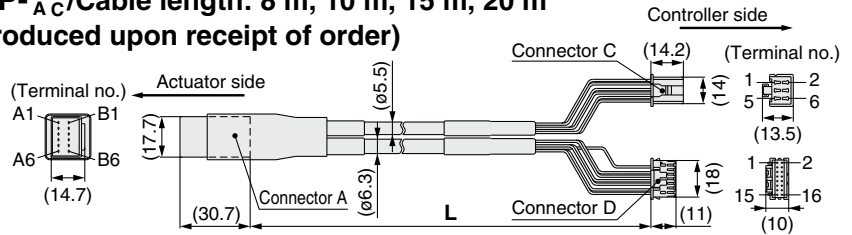

[Robotic cable, standard cable with lock and sensor for step motor (Servo/24 VDC)]

LE-CP-1-B-□

Cable length (L) [m]

1	1.5
3	3
5	5
8	8*1
A	10*1
B	15*1
C	20*1

*1 Produced upon receipt of order (Robotic cable only)

With lock and sensor

Cable type

Nil	Robotic cable (Flexible cable)
S	Standard cable

Weight

Product no.	Weight [g]	Note
LE-CP-1-B-S	240	Standard cable
LE-CP-3-B-S	380	
LE-CP-5-B-S	630	
LE-CP-1-B	190	Robotic cable
LE-CP-3-B	360	
LE-CP-5-B	590	
LE-CP-8-B	1060	
LE-CP-A-B	1320	
LE-CP-B-B	1920	
LE-CP-C-B	2620	

LE-CP-¹/₅/Cable length: 1.5 m, 3 m, 5 m

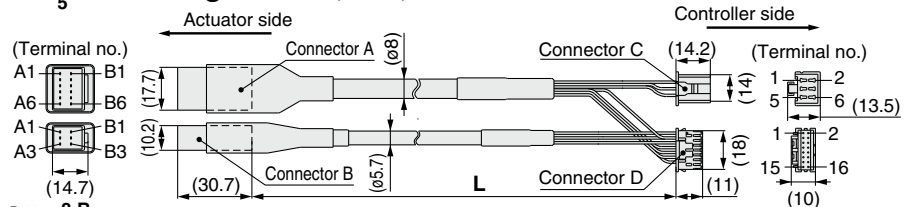

LE-CP-^{8 B}/_{A C}/Cable length: 8 m, 10 m, 15 m, 20 m
(*1 Produced upon receipt of order)

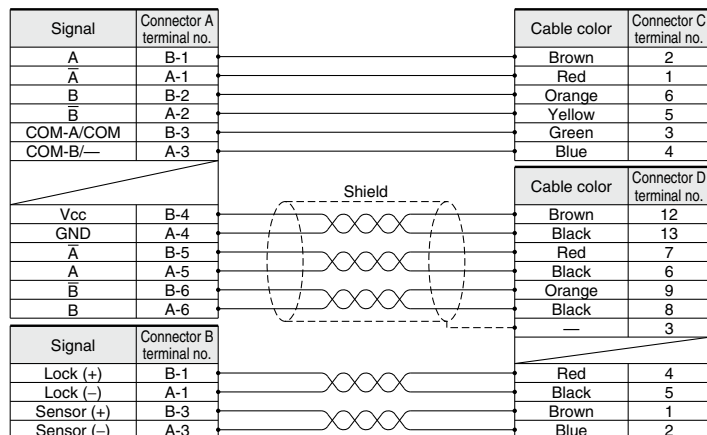
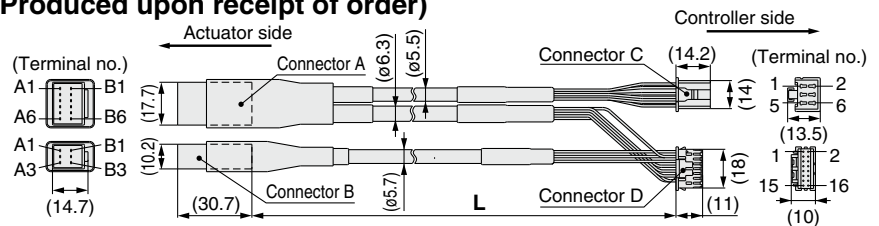

JXC51/61 Series

Options: Actuator Cable

[Robotic cable for battery-less absolute (Step motor 24 VDC)]

LE-CE-1

Cable length (L) [m]

1	1.5
3	3
5	5
8	8*1
A	10*1
B	15*1
C	20*1

*1 Produced upon receipt of order

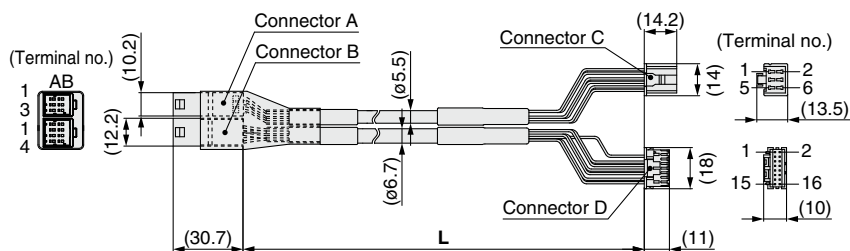

Weight

Product no.	Weight [g]	Note
LE-CE-1	190	Robotic cable
LE-CE-3	360	
LE-CE-5	570	
LE-CE-8	900	
LE-CE-A	1120	
LE-CE-B	1680	
LE-CE-C	2210	

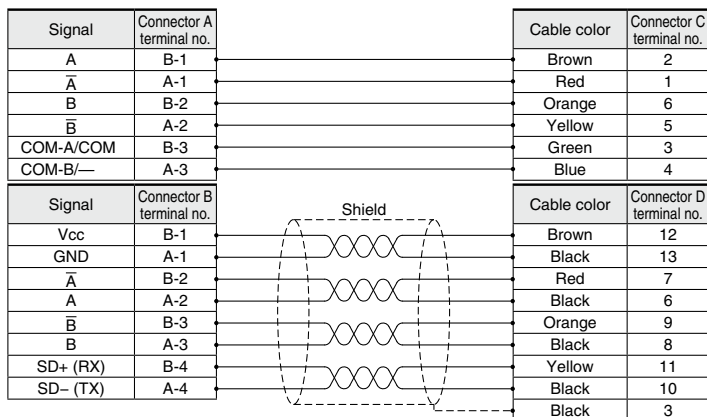

[Robotic cable with lock for battery-less absolute (Step motor 24 VDC)]

LE-CE-1-B

Cable length (L) [m]

1	1.5
3	3
5	5
8	8*1
A	10*1
B	15*1
C	20*1

*1 Produced upon receipt of order

With lock and sensor

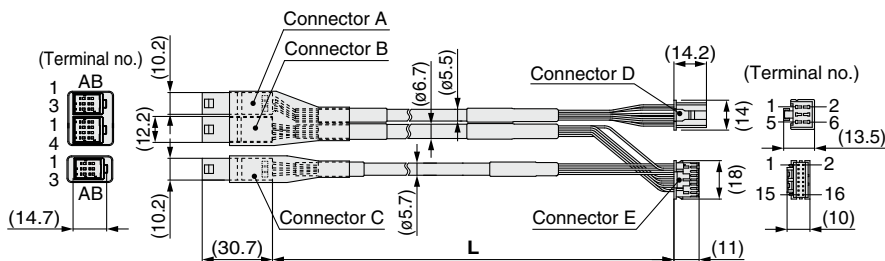

Weight

Product no.	Weight [g]	Note
LE-CE-1-B	240	Robotic cable
LE-CE-3-B	460	
LE-CE-5-B	740	
LE-CE-8-B	1170	
LE-CE-A-B	1460	
LE-CE-B-B	2120	
LE-CE-C-B	2890	

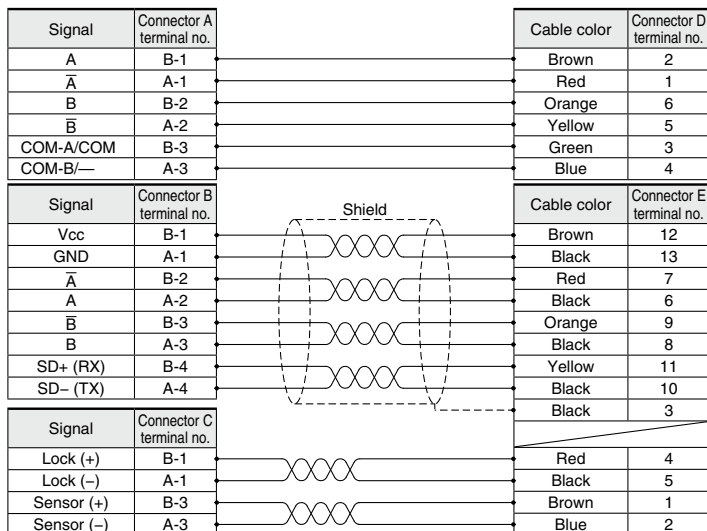

Options

■ Communication cable for controller setting

① Communication cable JXC-W2A-C

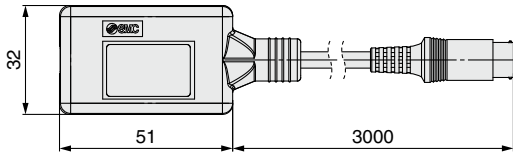

* It can be connected to the controller directly.

② USB cable LEC-W2-U

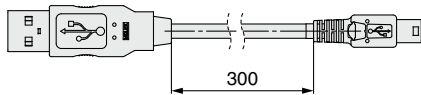

③ Controller setting kit JXC-W2A

A set which includes a communication cable (JXC-W2A-C) and a USB cable (LEC-W2-U)

<Controller setting software/USB driver>

- Controller setting software
 - USB driver (For JXC-W2A-C)
- Download from SMC's website.

Hardware Requirements

OS	Windows®7, Windows®8.1, Windows®10
Communication interface	USB 1.1 or USB 2.0 ports
Display	1024 x 768 or more

* Windows®7, Windows®8.1, and Windows®10 are registered trademarks of Microsoft Corporation in the United States.

■ Conversion cable P5062-5 (Cable length: 300 mm)

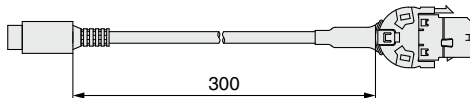

* To connect the teaching box (LEC-T1-3□□□) or communication cable for controller setting (LEC-W2A-C) to the controller, a conversion cable is required.

■ I/O Cable

LEC-CN5-1

Cable length (L) [m]

1	1.5
3	3
5	5

* Conductor size: AWG28

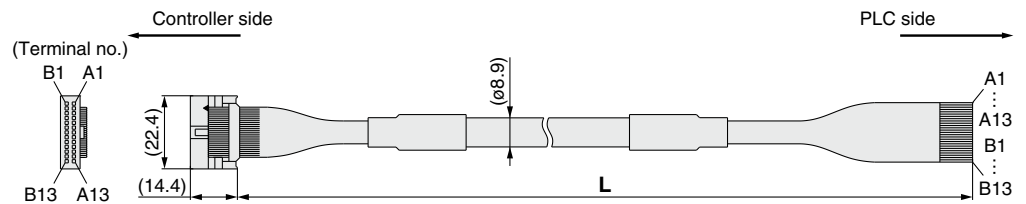

Connector pin no.	Insulation color	Dot mark	Dot color
A1	Light brown	■	Black
A2	Light brown	■	Red
A3	Yellow	■	Black
A4	Yellow	■	Red
A5	Light green	■	Black
A6	Light green	■	Red
A7	Gray	■	Black
A8	Gray	■	Red
A9	White	■	Black
A10	White	■	Red
A11	Light brown	■ ■	Black
A12	Light brown	■ ■	Red
A13	Yellow	■ ■	Black

Connector pin no.	Insulation color	Dot mark	Dot color
B1	Yellow	■ ■	Red
B2	Light green	■ ■	Black
B3	Light green	■ ■	Red
B4	Gray	■ ■	Black
B5	Gray	■ ■	Red
B6	White	■ ■	Black
B7	White	■ ■	Red
B8	Light brown	■ ■ ■	Black
B9	Light brown	■ ■ ■	Red
B10	Yellow	■ ■ ■	Black
B11	Yellow	■ ■ ■	Red
B12	Light green	■ ■ ■	Black
B13	Light green	■ ■ ■	Red
—			Shield

Weight

Product no.	Weight [g]
LEC-CN5-1	170
LEC-CN5-3	320
LEC-CN5-5	520

■ Power supply plug JXC-CPW

* The power supply plug is an accessory.

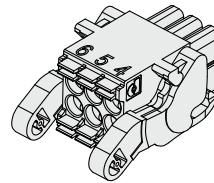

<Applicable cable size>
AWG20 (0.5 mm²), cover diameter 2.0 mm or less

⑥	⑤	④	①	③	②	①
①	C24V	④	0V	⑤	N.C.	
②	M24V	⑥	LK RLS			
③	EMG					

Power supply plug

Terminal name	Function	Details
0V	Common supply (-)	The M24V terminal, C24V terminal, EMG terminal, and LK RLS terminal are common (-).
M24V	Motor power supply (+)	Motor power supply (+) of the controller
C24V	Control power supply (+)	Control power supply (+) of the controller
EMG	Stop (+)	Connection terminal of the external stop circuit
LK RLS	Lock release (+)	Connection terminal of the lock release switch

■ Teaching box

LEC-T1-3 J G

Teaching box

Cable length [m]
3 3

Initial language

J	Japanese
E	English

* The displayed language can be changed to English or Japanese.



Enable switch (Option)

Nil	None
S	Equipped with enable switch

* Interlock switch for jog and test function

Stop switch

G	Equipped with stop switch
---	---------------------------

Specifications

Item	Description
Switch	Stop switch, Enable switch (Option)
Cable length [m]	3
Enclosure	IP64 (Except connector)
Operating temperature range [°C]	5 to 50
Operating humidity range [%RH]	90 or less (No condensation)
Weight [g]	350 (Except cable)

Step Motor Controller

JXCE1/91/P1/D1/L□/M1 Series



* Excluding the JXCLF



How to Order

JXC **D** **1** **7** **T** - □

Communication protocol

		Standard	With STO sub-function
E	EtherCAT	●	—
9	EtherNet/IP™	●	—
P	PROFINET	●	—
D	DeviceNet®	●	—
L	IO-Link	●	●
M	CC-Link	●	—

Number of axes, Special specification

1	1 axis, Standard
F	1 axis, With STO sub-function

Mounting

7	Screw mounting
8*1	DIN rail

*1 The DIN rail is not included. It must be ordered separately. (Refer to page 25.)

Option

Nil	Without option
S	With straight type communication plug
T	With T-branch type communication plug

* Select "Nil" for anything other than JXCD1 and JXCM1.

Actuator part number

Without cable specifications and actuator options
Example: Enter "LEFS16B-100"
for the LEFS16B-100B-S1□□.

BC	Blank controller*1
-----------	--------------------

*1 Requires dedicated software (JXC-BCW)

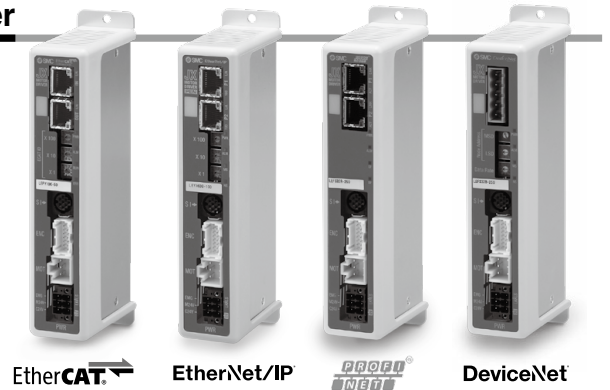

EtherCAT

EtherNet/IP

PROFINET

DeviceNet



IO-Link

CC-Link

With STO sub-function

IO-Link

JXC51/61 Series

JXCE1/91/P1/D1/L□/M1 Series

The controller is sold as single unit after the compatible actuator is set.

Confirm that the combination of the controller and actuator is correct.

- Check the actuator label for the model number. This number should match that of the controller.

LEFS16B-400

①



* Refer to the operation manual for using the products. Please download it via our website.

Precautions for blank controllers (JXC□□□□-BC)

A blank controller is a controller to which the customer can write the data of the actuator it is to be combined and used with. Use the dedicated software (JXC-BCW) for data writing.

- Please download the dedicated software (JXC-BCW) via our website.
- Order the communication cable for controller setting (JXC-W2A-C) and USB cable (LEC-W2-U) separately to use this software.

JXCE1/91/P1/D1/L□/M1 Series

Specifications

Model		JXCE1	JXC91	JXCP1	JXCD1	JXCL1	JXCLF	JXCM1	
Network		EtherCAT	EtherNet/IP™	PROFINET	DeviceNet®	IO-Link		CC-Link	
Compatible motor		Step motor (Servo/24 VDC)							
Power supply		Power voltage: 24 VDC ±10%							
Current consumption (Controller)		200 mA or less	130 mA or less	200 mA or less	100 mA or less	100 mA or less		100 mA or less	
Compatible encoder		Incremental/Battery-less absolute							
Communication specifications	Applicable system	Protocol	EtherCAT*2	EtherNet/IP™*2	PROFINET*2	DeviceNet®	IO-Link		CC-Link
		Version*1	Conformance Test Record V.1.2.6	Volume 1 (Edition 3.14) Volume 2 (Edition 1.15)	Specification Version 2.32	Volume 1 (Edition 3.14) Volume 3 (Edition 1.13)	Version 1.1 Port Class A		Ver. 1.10
	Communication speed	100 Mbps*2	10/100 Mbps*2 (Automatic negotiation)	100 Mbps*2	125/250/500 kbps	230.4 kbps (COM3)		156 kbps, 625 kbps, 2.5 Mbps, 5 Mbps, 10 Mbps	
	Configuration file*3	ESI file	EDS file	GSDML file	EDS file	IODD file		CSP+ file	
	I/O occupation area	Input 20 bytes Output 36 bytes	Input 36 bytes Output 36 bytes	Input 36 bytes Output 36 bytes	Input 4, 10, 20 bytes Output 4, 12, 20, 36 bytes	Input 14 bytes Output 22 bytes		1 station, 2 stations, 4 stations	
	Terminating resistor	Not included							
Memory		EEPROM							
LED indicator		PWR, RUN, ALM, ERR	PWR, ALM, MS, NS	PWR, ALM, SF, BF	PWR, ALM, MS, NS	PWR, ALM, COM		PWR, ALM, L ERR, L RUN	
Cable length [m]		Actuator cable: 20 or less							
Cooling system		Natural air cooling							
Operating temperature range [°C]		0 to 55 (No freezing)*4							
Operating humidity range [%RH]		90 or less (No condensation)							
Insulation resistance [MΩ]		Between all external terminals and the case: 50 (500 VDC)							
Safety function		—		—		STO, SS1-t		—	
Safety standards		—		—		EN 61508 SIL 3*5 EN 62061 SIL CL 3*5 EN ISO 13849-1 Cat. 3 PL e*5		—	
Weight [g]	Screw mounting	220	210	220	210	190	220	170	
	DIN rail mounting	240	230	240	230	210	240	190	

*1 Please note that versions are subject to change.

*2 Use a shielded communication cable with CAT5 or higher for the PROFINET, EtherNet/IP™, and EtherCAT.

*3 The files can be downloaded from the SMC website.

*4 The operating temperature range for both controller version 1 products and controller version 2 products is 0 to 40°C. Refer to the **Web Catalog** for details on identifying controller version symbols.

*5 The above safety integrity level is the max. value. The achievable level varies depending on the configuration and inspection method of the component. Be sure to refer to "Safety Manual: JXC#-OMY0009" for more information.

■Trademark

EtherNet/IP® is a registered trademark of ODVA, Inc.

DeviceNet® is a registered trademark of ODVA, Inc.

EtherCAT® is registered trademark and patented technology, licensed by Beckhoff Automation GmbH, Germany.

Example of Operation Command

In addition to the step data input of 64 points maximum in each communication protocol, the changing of each parameter can be performed in real time via numerical data defined operation.

* Numerical values other than "Moving force," "Area 1," and "Area 2" can be used to perform operation under numerical instructions from JXCL□.

<Application example> Movement between 2 points

No.	Movement mode	Speed	Position	Acceleration	Deceleration	Pushing force	Trigger LV	Pushing speed	Moving force	Area 1	Area 2	In position
0	1: Absolute	100	10	3000	3000	0	0	0	100	0	0	0.50
1	1: Absolute	100	100	3000	3000	0	0	0	100	0	0	0.50

<Step no. defined operation>

Sequence 1: Servo ON instruction

Sequence 2: Instruction to return to origin

Sequence 3: Specify step data No. 0 to input the DRIVE signal.

Sequence 4: Specify step data No. 1 after the DRIVE signal has been temporarily turned OFF to input the DRIVE signal.

<Numerical data defined operation>

Sequence 1: Servo ON instruction

Sequence 2: Instruction to return to origin

Sequence 3: Specify step data No. 0 and turn ON the input instruction flag (position). Input 10 in the target position. Subsequently the start flag turns ON.

Sequence 4: Turn ON step data No. 0 and the input instruction flag (position) to change the target position to 100 while the start flag is ON.

The same operation can be performed with any operation command.

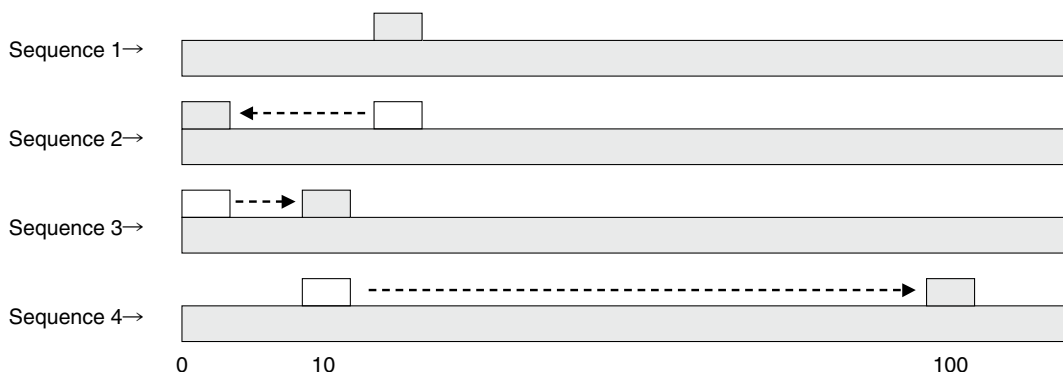

Dimensions

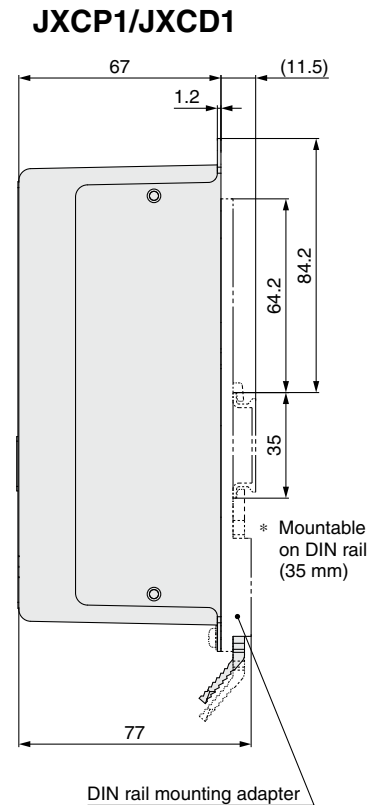
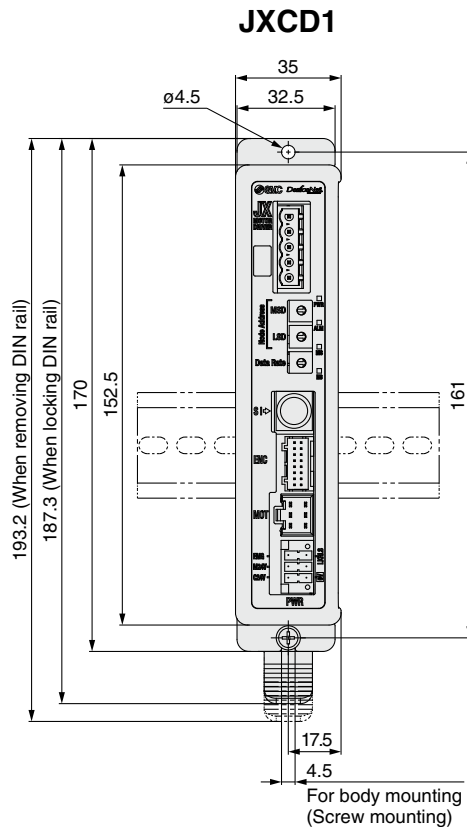
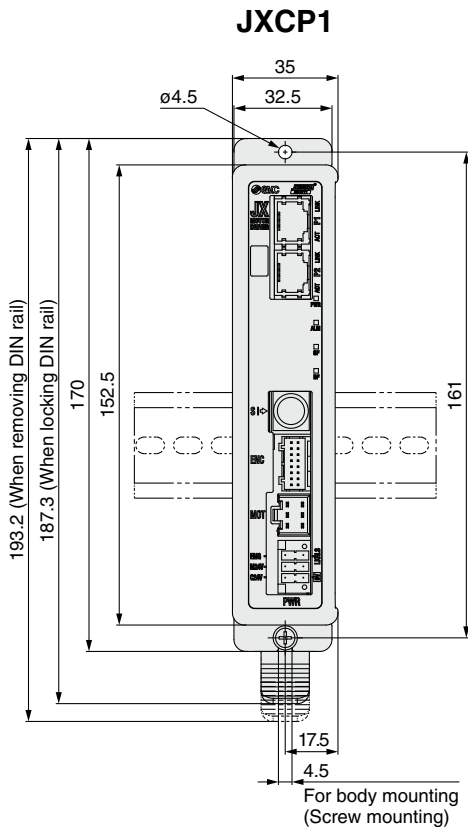
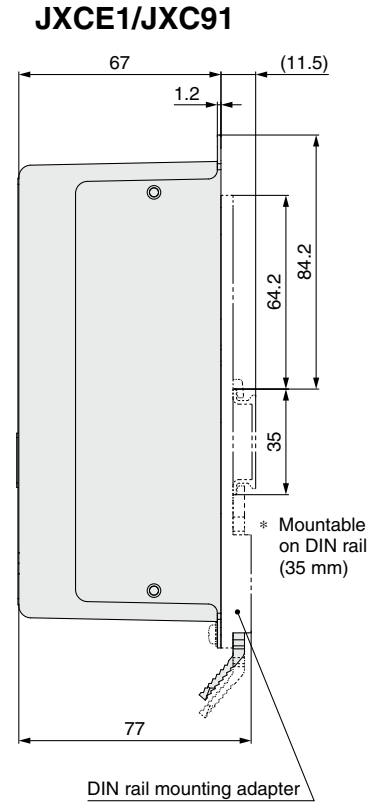
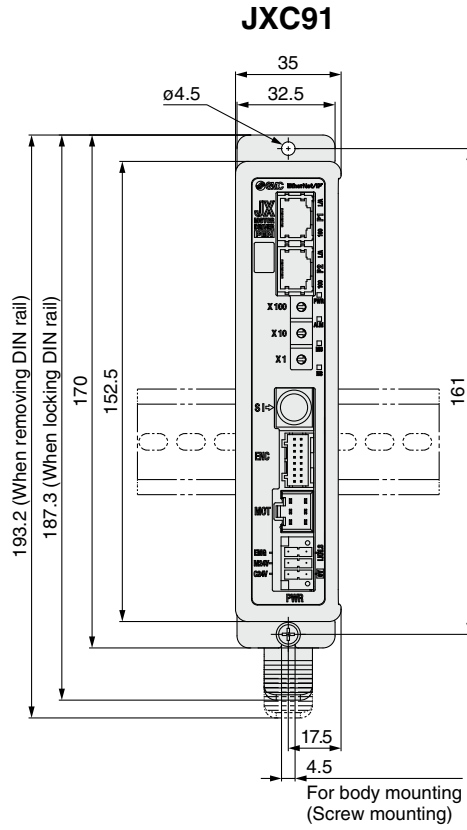
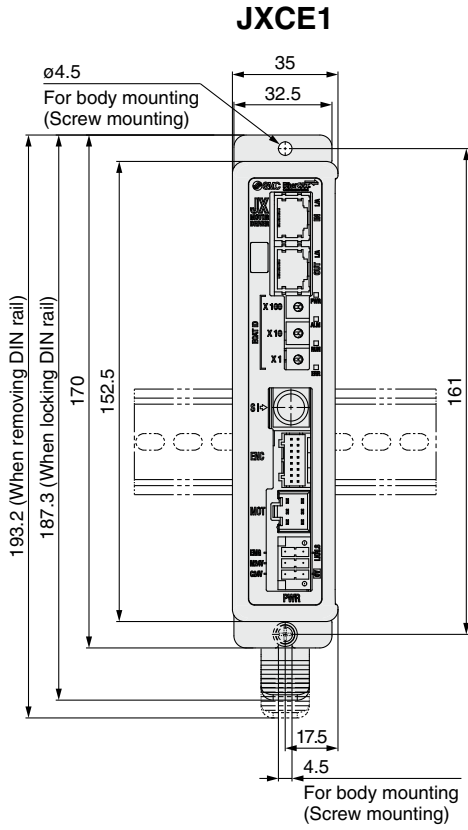

JXC51/61 Series

JXCE1/91/P1/D1/L□/M1 Series

JXCE1/91/P1/D1/L□/M1 Series

Dimensions

JXCL1

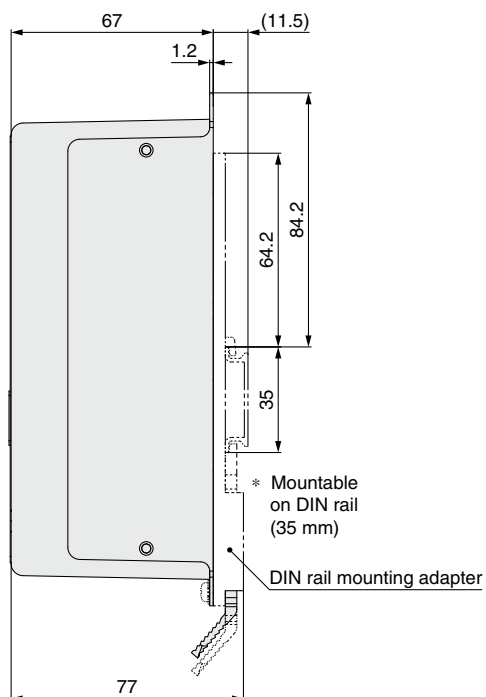
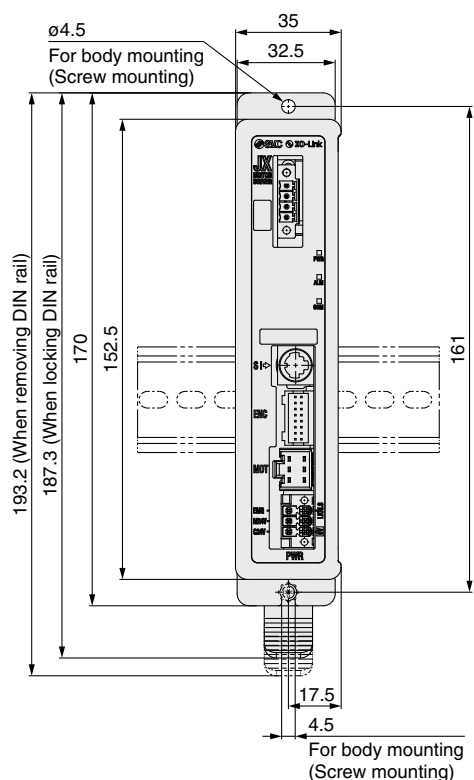

JXCM1

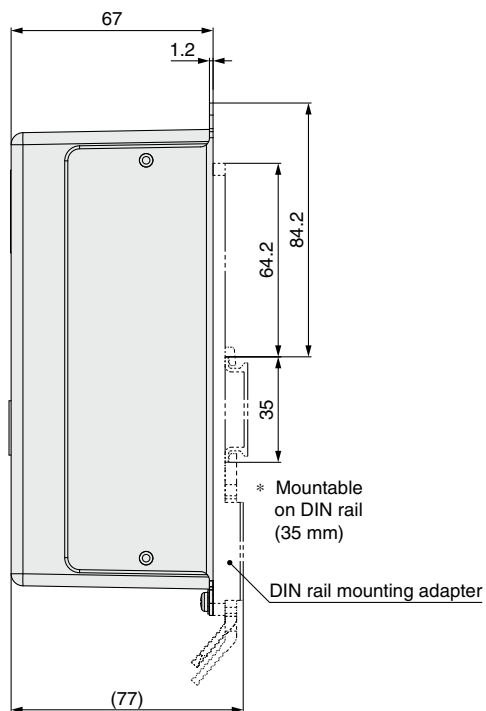
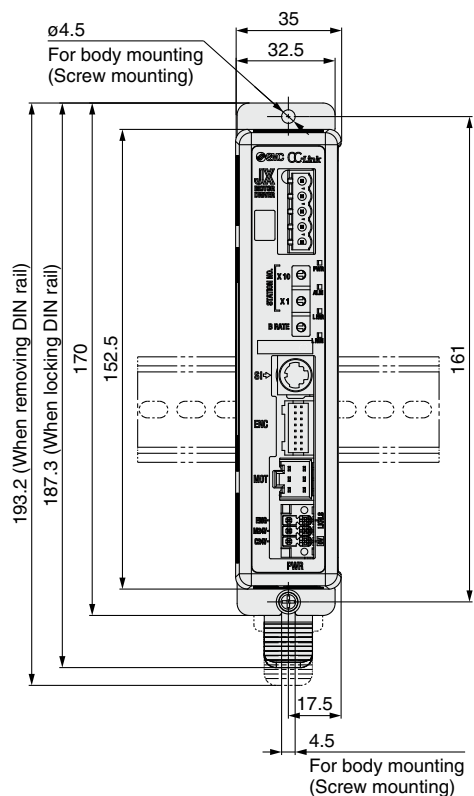

Dimensions

JXCLF

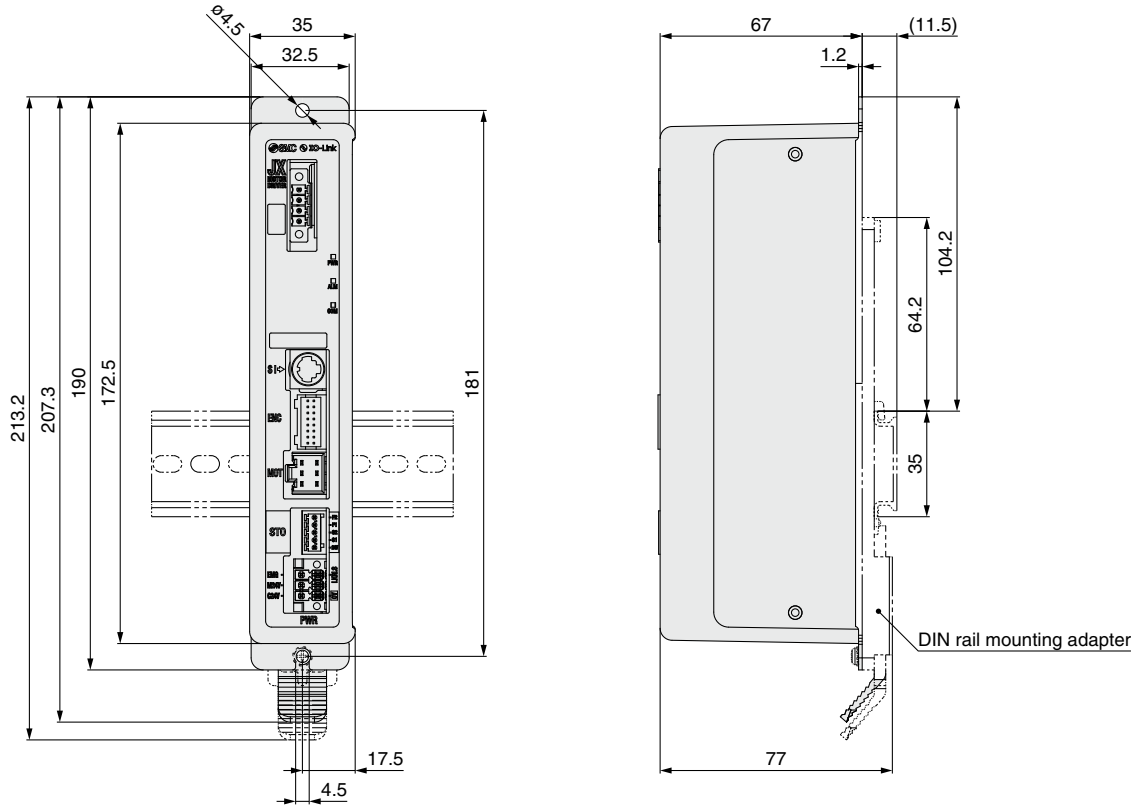

DIN rail AXT100-DR-□

* For □, enter a number from the No. line in the table below.
Refer to the dimension drawings on pages 20 to 22 for the mounting dimensions.

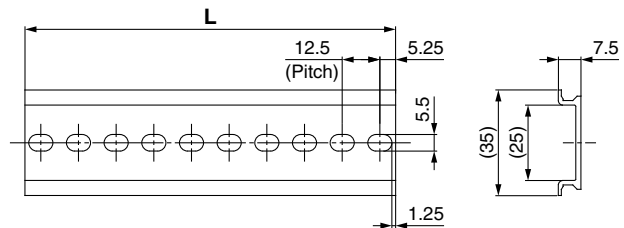

L Dimensions [mm]

No.	1	2	3	4	5	6	7	8	9	10	11	12	13	14	15	16	17	18	19	20
L	23	35.5	48	60.5	73	85.5	98	110.5	123	135.5	148	160.5	173	185.5	198	210.5	223	235.5	248	260.5
No.	21	22	23	24	25	26	27	28	29	30	31	32	33	34	35	36	37	38	39	40
L	273	285.5	298	310.5	323	335.5	348	360.5	373	385.5	398	410.5	423	435.5	448	460.5	473	485.5	498	510.5

DIN rail mounting adapter LEC-3-D0 (with 2 mounting screws)

This should be used when the DIN rail mounting adapter is mounted onto a screw mounting type controller afterward.

JXCE1/91/P1/D1/L□/M1 Series

Actuator Cable

[Robotic cable, standard cable for step motor (Servo/24 VDC)]

LE-CP-1-□

Cable length (L) [m]

1	1.5
3	3
5	5
8	8*1
A	10*1
B	15*1
C	20*1

*1 Produced upon receipt of order (Robotic cable only)

Cable type

Nil	Robotic cable (Flexible cable)
S	Standard cable

Weight

Product no.	Weight [g]	Note
LE-CP-1-S	190	Standard cable
LE-CP-3-S	280	
LE-CP-5-S	460	
LE-CP-1	140	Robotic cable
LE-CP-3	260	
LE-CP-5	420	
LE-CP-8	790	
LE-CP-A	980	
LE-CP-B	1460	
LE-CP-C	1940	

LE-CP-¹/₅/Cable length: 1.5 m, 3 m, 5 m

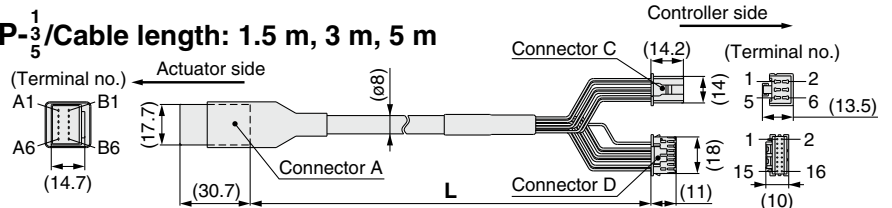

LE-CP-^{8 B}/_{A C}/Cable length: 8 m, 10 m, 15 m, 20 m
(*1 Produced upon receipt of order)

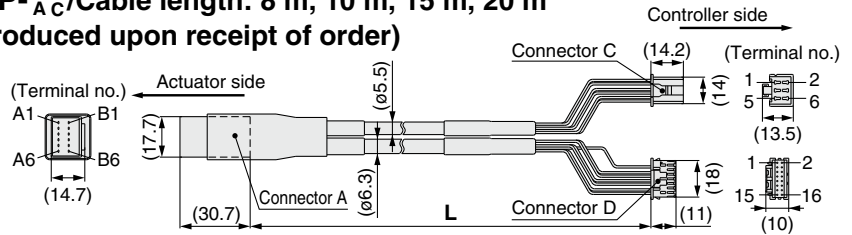

Signal	Connector A terminal no.	Cable color	Connector C terminal no.
A	B-1	Brown	2
A	A-1	Red	1
B	B-2	Orange	6
B	A-2	Yellow	5
COM-A/COM	B-3	Green	3
COM-B/-	A-3	Blue	4

Signal	Connector A terminal no.	Cable color	Connector D terminal no.
Vcc	B-4	Brown	12
GND	A-4	Black	13
A	B-5	Red	7
A	A-5	Black	6
B	B-6	Orange	9
B	A-6	Black	8
		-	3

[Robotic cable, standard cable with lock and sensor for step motor (Servo/24 VDC)]

LE-CP-1-B-□

Cable length (L) [m]

1	1.5
3	3
5	5
8	8*1
A	10*1
B	15*1
C	20*1

*1 Produced upon receipt of order (Robotic cable only)

With lock and sensor

Cable type

Nil	Robotic cable (Flexible cable)
S	Standard cable

Weight

Product no.	Weight [g]	Note
LE-CP-1-B-S	240	Standard cable
LE-CP-3-B-S	380	
LE-CP-5-B-S	630	
LE-CP-1-B	190	Robotic cable
LE-CP-3-B	360	
LE-CP-5-B	590	
LE-CP-8-B	1060	
LE-CP-A-B	1320	
LE-CP-B-B	1920	
LE-CP-C-B	2620	

LE-CP-¹/₅/Cable length: 1.5 m, 3 m, 5 m

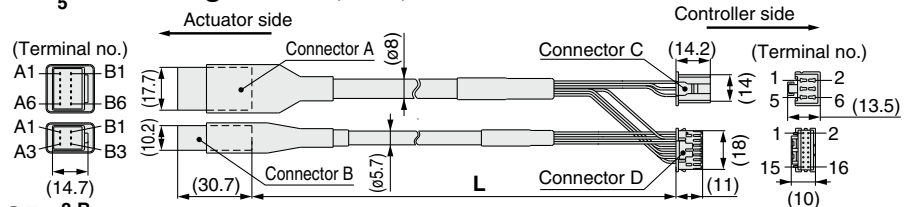

LE-CP-^{8 B}/_{A C}/Cable length: 8 m, 10 m, 15 m, 20 m
(*1 Produced upon receipt of order)

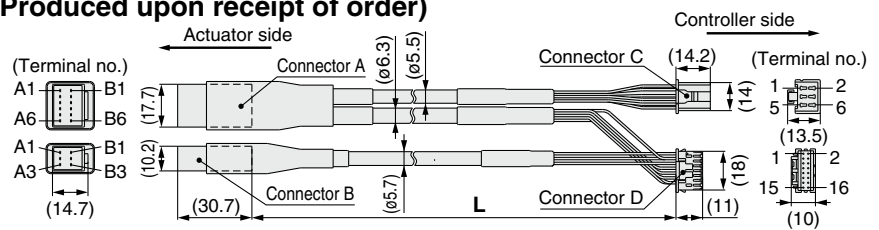

Signal	Connector A terminal no.	Cable color	Connector C terminal no.
A	B-1	Brown	2
A	A-1	Red	1
B	B-2	Orange	6
B	A-2	Yellow	5
COM-A/COM	B-3	Green	3
COM-B/-	A-3	Blue	4

Signal	Connector A terminal no.	Cable color	Connector D terminal no.
Vcc	B-4	Brown	12
GND	A-4	Black	13
A	B-5	Red	7
A	A-5	Black	6
B	B-6	Orange	9
B	A-6	Black	8
		-	3

Signal	Connector B terminal no.	Cable color	Connector C terminal no.
Lock (+)	B-1	Red	4
Lock (-)	A-1	Black	5
Sensor (+)	B-3	Brown	1
Sensor (-)	A-3	Blue	2

Options: Actuator Cable

[Robotic cable for battery-less absolute (Step motor 24 VDC)]

LE-CE-1

Cable length (L) [m]

1	1.5
3	3
5	5
8	8*1
A	10*1
B	15*1
C	20*1

*1 Produced upon receipt of order

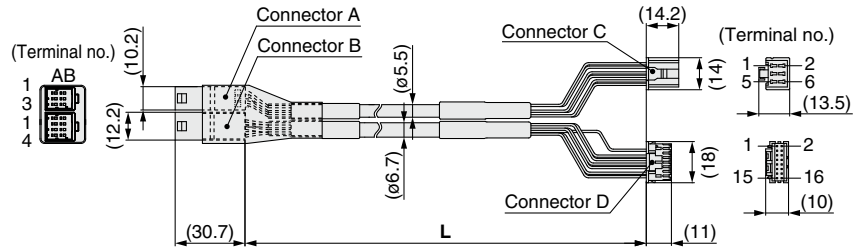

Weight

Product no.	Weight [g]	Note
LE-CE-1	190	Robotic cable
LE-CE-3	360	
LE-CE-5	570	
LE-CE-8	900	
LE-CE-A	1120	
LE-CE-B	1680	
LE-CE-C	2210	

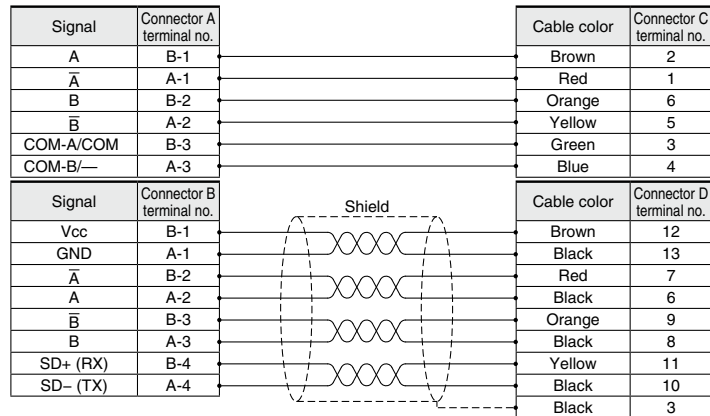

[Robotic cable with lock for battery-less absolute (Step motor 24 VDC)]

LE-CE-1-B

Cable length (L) [m]

1	1.5
3	3
5	5
8	8*1
A	10*1
B	15*1
C	20*1

*1 Produced upon receipt of order

With lock and sensor

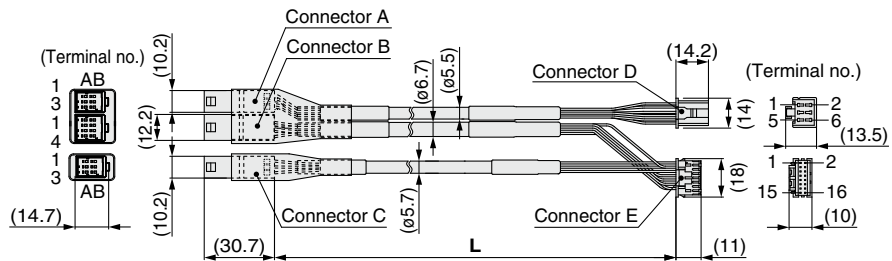

Weight

Product no.	Weight [g]	Note
LE-CE-1-B	240	Robotic cable
LE-CE-3-B	460	
LE-CE-5-B	740	
LE-CE-8-B	1170	
LE-CE-A-B	1460	
LE-CE-B-B	2120	
LE-CE-C-B	2890	

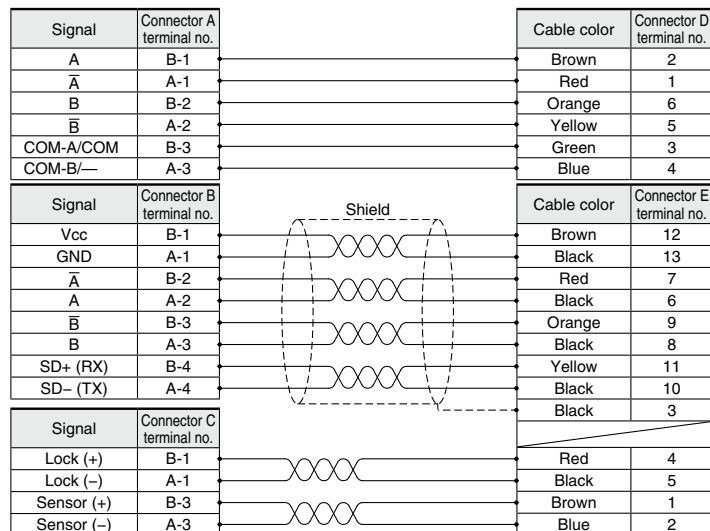

JXCE1/91/P1/D1/L□/M1 Series

Options

■ Communication cable for controller setting

① Communication cable JXC-W2A-C

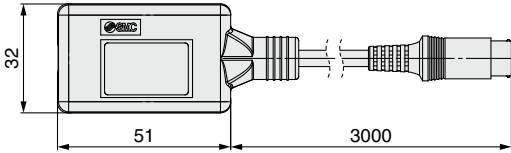

* It can be connected to the controller directly.

② USB cable LEC-W2-U

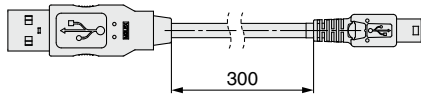

③ Controller setting kit JXC-W2A

A set which includes a communication cable (JXC-W2A-C) and a USB cable (LEC-W2-U)

<Controller setting software/USB driver>

- Controller setting software
 - USB driver (For JXC-W2A-C)
- Download from SMC's website.

Hardware Requirements

OS	Windows®7, Windows®8.1, Windows®10
Communication interface	USB 1.1 or USB 2.0 ports
Display	1024 x 768 or more

* Windows®7, Windows®8.1, and Windows®10 are registered trademarks of Microsoft Corporation in the United States.

■ Conversion cable P5062-5 (Cable length: 300 mm)

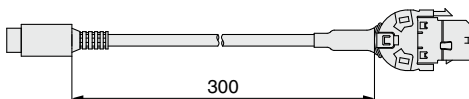

* To connect the teaching box (LEC-T1-3□G□) or communication cable for controller setting (LEC-W2A-C) to the controller, a conversion cable is required.

■ DIN rail mounting adapter LEC-3-D0

* With 2 mounting screws

This should be used when the DIN rail mounting adapter is mounted onto a screw mounting type controller afterward.

■ DIN rail AXT100-DR-□

* For □, enter a number from the No. line in the table on page 22. Refer to the dimension drawings on pages 20 to 22 for the mounting dimensions.

■ Teaching box

LEC-T1-3□G□

Teaching box

Cable length [m]
3 3

Initial language

J	Japanese
E	English

* The displayed language can be changed to English or Japanese.

Enable switch (Option)

Enable switch

Nil	None
S	Equipped with enable switch

* Interlock switch for jog and test function

Stop switch

G Equipped with stop switch



Specifications

Item	Description
Switch	Stop switch, Enable switch (Option)
Cable length [m]	3
Enclosure	IP64 (Except connector)
Operating temperature range [°C]	5 to 50
Operating humidity range [%RH]	90 or less (No condensation)
Weight [g]	350 (Except cable)

Options

■ Power supply plug JXC-CPW

* The power supply plug is an accessory.

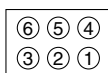
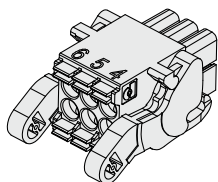

- ① C24V ④ 0V
- ② M24V ⑤ N.C.
- ③ EMG ⑥ LK RLS

Power supply plug

Terminal name	Function	Details
0V	Common supply (-)	The M24V terminal, C24V terminal, EMG terminal, and LK RLS terminal are common (-).
M24V	Motor power supply (+)	Motor power supply (+) of the controller
C24V	Control power supply (+)	Control power supply (+) of the controller
EMG	Stop (+)	Connection terminal of the external stop circuit
LK RLS	Lock release (+)	Connection terminal of the lock release switch

■ STO signal plug JXC-CSTO

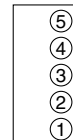

STO signal plug

Pin no.	Signal name	Details
1	24V	+24 V output (Max. 100 mA)
2	STO1	STO input 1
3	STO2	STO input 2
4	Feedback 1	STO1 feedback signal
5	Feedback 2	STO2 feedback signal

■ Communication plug connector

For DeviceNet®

Straight type
JXC-CD-S

T-branch type
JXC-CD-T

Communication plug connector for DeviceNet®

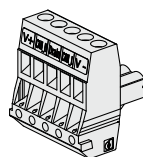
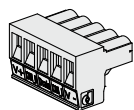

Terminal name	Details
V+	Power supply (+) for DeviceNet®
CAN_H	Communication wire (High)
Drain	Grounding wire/Shielded wire
CAN_L	Communication wire (Low)
V-	Power supply (-) for DeviceNet®

For IO-Link

Straight type
JXC-CL-S

* The communication plug connector for IO-Link is an accessory.

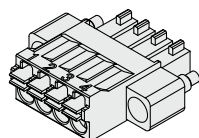

Communication plug connector for IO-Link

Terminal no.	Terminal name	Details
1	L+	+24 V
2	NC	N/A
3	L-	0 V
4	C/Q	IO-Link signal

For CC-Link

Straight type
LEC-CMJ-S

T-branch type
LEC-CMJ-T

Communication plug connector for CC-Link



Terminal name	Details
DA	CC-Link communication line A
DB	CC-Link communication line B
DG	CC-Link ground line
SLD	CC-Link shield
FG	Frame ground



JXC51/61/E1/91/P1/D1/L□/M1 Series Precautions Relating to Differences in Controller Versions

As the controller version of the JXC series differs, the internal parameters are not compatible.

- If using the JXC□□-BC, please use the latest version of the JXC-BCW (parameter writing tool).
- There are currently 3 versions available: version 1 products (V1.□ or S1.□), version 2 products (V2.□ or S2.□), and version 3 products (V3.□ or S3.□). Keep in mind that in order to write a backup file (.bcp) to another controller with the JXC-BCW, it needs to be the same version as the controller that created the file. (For example, a backup file created by a version 1 product can only be written to another version 1 product, and so on.)

Identifying Version Symbols

JXC□□ Series Version V3.□ or S3.□ Products

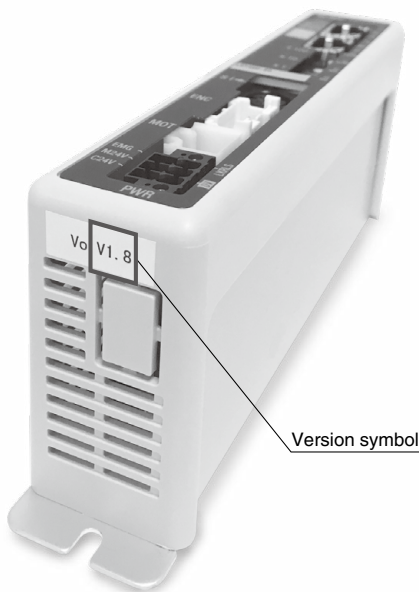

XR V3.0

Applicable models

JXC91□ Series

XR S3.0 T1.0

Applicable models

JXC51□ Series

JXC61□ Series

JXCE1□ Series

JXCP1□ Series

JXCD1□ Series

JXCL□□ Series

JXCM1□ Series

JXC□□ Series Version V2.□ or S2.□ Products

WP V2.1

Applicable models

JXC91□ Series

WP S2.2 T1.1

Applicable models

JXCE1□ Series

JXCP1□ Series

JXCD1□ Series

JXCL□□ Series

JXC□□ Series Version V1.□ or S1.□ Products

XR V1.0

Applicable models

JXC91□ Series

XR S1.0 T1.0

Applicable models

JXCE1□ Series

JXCP1□ Series

JXCD1□ Series

JXCL□□ Series

Precautions Relating to Differences in Controller Versions **JXC51/61/E1/91/P1/D1/L□/M1 Series**

Blank Controller Versions and Applicable Battery-less Absolute Type Electric Actuator Sizes

- The applicable battery-less absolute type electric actuator size range differs depending on the controller version.
Be sure to confirm the controller version before using a blank controller.

Blank Controller Versions/Applicable Electric Actuator Sizes

Blank controller		Applicable electric actuator size										
Series	Controller version	LEFS□E	LEFB□E	LEKFS□E	LEY□E	LEY□E-X8	LEYG□E	LES□E	LESH□E	LESYH□E	LER□E	LEHF□E
JXC91□ series JXCD1□ series JXCE1□ series JXCP1□ series JXCL1□ series	Version 3.4 (V3.4, S3.4) Version 3.5 (V3.5, S3.5)	25, 32, 40	25, 32, 40	25, 32, 40	25, 32, 40	25, 32, 40	25, 32, 40	25	25	16, 25	50	32, 40
	Version 3.6 (V3.6, S3.6) or higher	16, 25, 32, 40	16, 25, 32, 40		16, 25, 32, 40		16, 25, 32, 40			8, 16, 25		
JXCM1□ series JXC51/61 series	Version 3.4 (V3.4, S3.4)	25, 32, 40	25, 32, 40		25, 32, 40		25, 32, 40			16, 25		
	Version 3.5 (V3.5, S3.5) or higher	16, 25, 32, 40	16, 25, 32, 40	16, 25, 32, 40	16, 25, 32, 40	8, 16, 25						

JXC51/61 Series

JXCE1/91/P1/D1/L□/M1 Series

Safety Instructions

These safety instructions are intended to prevent hazardous situations and/or equipment damage. These instructions indicate the level of potential hazard with the labels of “**Caution**,” “**Warning**” or “**Danger**.” They are all important notes for safety and must be followed in addition to International Standards (ISO/IEC)*1), and other safety regulations.

 **Caution:** **Caution** indicates a hazard with a low level of risk which, if not avoided, could result in minor or moderate injury.

 **Warning:** **Warning** indicates a hazard with a medium level of risk which, if not avoided, could result in death or serious injury.

 **Danger :** **Danger** indicates a hazard with a high level of risk which, if not avoided, will result in death or serious injury.

*1) ISO 4414: Pneumatic fluid power – General rules relating to systems.
ISO 4413: Hydraulic fluid power – General rules relating to systems.
IEC 60204-1: Safety of machinery – Electrical equipment of machines.
(Part 1: General requirements)
ISO 10218-1: Manipulating industrial robots – Safety.
etc.

Warning

1. The compatibility of the product is the responsibility of the person who designs the equipment or decides its specifications.

Since the product specified here is used under various operating conditions, its compatibility with specific equipment must be decided by the person who designs the equipment or decides its specifications based on necessary analysis and test results. The expected performance and safety assurance of the equipment will be the responsibility of the person who has determined its compatibility with the product. This person should also continuously review all specifications of the product referring to its latest catalog information, with a view to giving due consideration to any possibility of equipment failure when configuring the equipment.

2. Only personnel with appropriate training should operate machinery and equipment.

The product specified here may become unsafe if handled incorrectly. The assembly, operation and maintenance of machines or equipment including our products must be performed by an operator who is appropriately trained and experienced.

3. Do not service or attempt to remove product and machinery/equipment until safety is confirmed.

1. The inspection and maintenance of machinery/equipment should only be performed after measures to prevent falling or runaway of the driven objects have been confirmed.
2. When the product is to be removed, confirm that the safety measures as mentioned above are implemented and the power from any appropriate source is cut, and read and understand the specific product precautions of all relevant products carefully.
3. Before machinery/equipment is restarted, take measures to prevent unexpected operation and malfunction.

4. Contact SMC beforehand and take special consideration of safety measures if the product is to be used in any of the following conditions.

1. Conditions and environments outside of the given specifications, or use outdoors or in a place exposed to direct sunlight.
2. Installation on equipment in conjunction with atomic energy, railways, air navigation, space, shipping, vehicles, military, medical treatment, combustion and recreation, or equipment in contact with food and beverages, emergency stop circuits, clutch and brake circuits in press applications, safety equipment or other applications unsuitable for the standard specifications described in the product catalog.
3. An application which could have negative effects on people, property, or animals requiring special safety analysis.
4. Use in an interlock circuit, which requires the provision of double interlock for possible failure by using a mechanical protective function, and periodical checks to confirm proper operation.

Caution

1. The product is provided for use in manufacturing industries.

The product herein described is basically provided for peaceful use in manufacturing industries.
If considering using the product in other industries, consult SMC beforehand and exchange specifications or a contract if necessary.
If anything is unclear, contact your nearest sales branch.

Limited warranty and Disclaimer/ Compliance Requirements

The product used is subject to the following “Limited warranty and Disclaimer” and “Compliance Requirements”.

Read and accept them before using the product.

Limited warranty and Disclaimer

1. The warranty period of the product is 1 year in service or 1.5 years after the product is delivered, whichever is first.*2)
Also, the product may have specified durability, running distance or replacement parts. Please consult your nearest sales branch.
2. For any failure or damage reported within the warranty period which is clearly our responsibility, a replacement product or necessary parts will be provided.
This limited warranty applies only to our product independently, and not to any other damage incurred due to the failure of the product.
3. Prior to using SMC products, please read and understand the warranty terms and disclaimers noted in the specified catalog for the particular products.

*2) Vacuum pads are excluded from this 1 year warranty.

A vacuum pad is a consumable part, so it is warranted for a year after it is delivered.
Also, even within the warranty period, the wear of a product due to the use of the vacuum pad or failure due to the deterioration of rubber material are not covered by the limited warranty.

Compliance Requirements

1. The use of SMC products with production equipment for the manufacture of weapons of mass destruction (WMD) or any other weapon is strictly prohibited.
2. The exports of SMC products or technology from one country to another are governed by the relevant security laws and regulations of the countries involved in the transaction. Prior to the shipment of a SMC product to another country, assure that all local rules governing that export are known and followed.

Caution

SMC products are not intended for use as instruments for legal metrology.

Measurement instruments that SMC manufactures or sells have not been qualified by type approval tests relevant to the metrology (measurement) laws of each country. Therefore, SMC products cannot be used for business or certification ordained by the metrology (measurement) laws of each country.

Revision History

Edition B * The JXCLF series controller with STO sub-function has been added.
* Number of pages has been increased from 24 to 32.

AR

Safety Instructions

Be sure to read the “Handling Precautions for SMC Products” (M-E03-3) and “Operation Manual” before use.

SMC Corporation