

# Direct Operated 3-Port Solenoid Valve

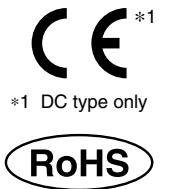

**Power consumption: 0.1 W<sup>\*2</sup>**  
(Standard type, With power-saving circuit)

**Coil temperature rise: 1°C**  
(Standard type, With power-saving circuit)

		<b>New</b> Large flow type (Type U)	Large flow type (Type A)	Standard type
Sonic conductance C[dm <sup>3</sup> /(s·bar)]		<b>0.16</b>	0.076	0.037
Power consumption [W]	Standard	—	1	0.35
	With power- saving circuit	0.35	—	<b>0.1<sup>*2</sup></b>

\*2 Refer to page 1 for details.

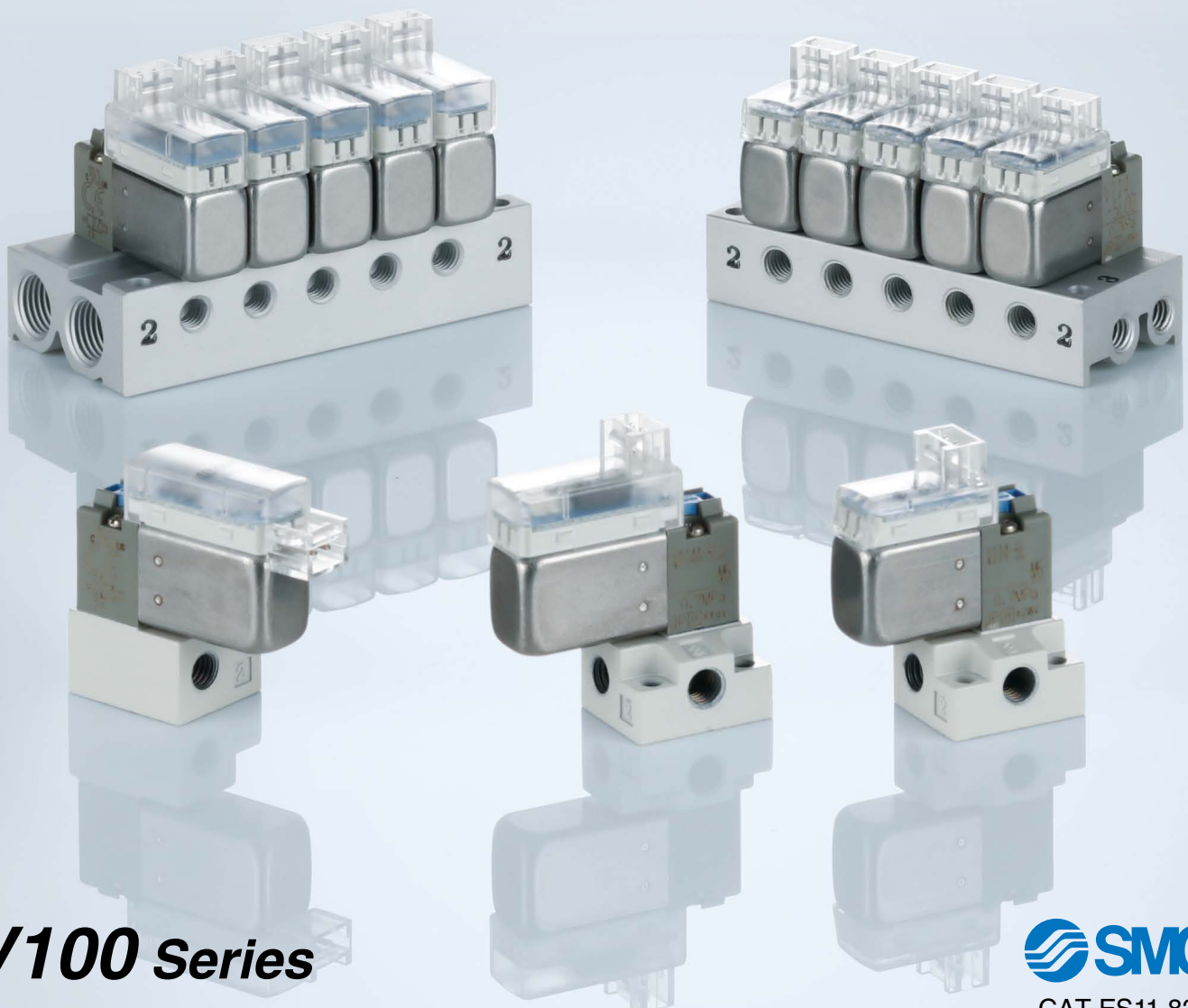

**V100 Series**

# Direct Operated 3-Port Solenoid Valve

# V100 Series

## Rubber Seal

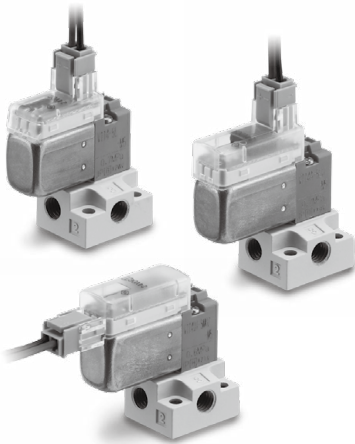
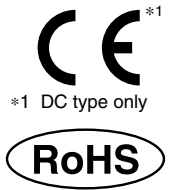

### Specifications

Fluid	Air
Ambient and fluid temperatures [°C]	-10 to 50 (No freezing)
Response time (DC) [ms]*1	ON: 5 or less OFF: 4 or less
Max. operating frequency [Hz]	20*3
Manual override	Non-locking push, Locking slotted
Lubrication	Not required
Mounting position	Unrestricted
Impact/Vibration resistance [m/s <sup>2</sup> ]*2	150/30
Enclosure	Dustproof

\*1 Based on the JIS B 8419: 2010 dynamic performance test (Standard type: Coil temperature 20°C, at rated voltage, without surge voltage suppressor)

\*2 Impact resistance: No malfunction occurred when tested with a drop tester in the axial direction and at a right angle to the armature in both an energized and a de-energized state, once in each condition. (Value in the initial state)

Vibration resistance: No malfunction occurred in a one-sweep test between 45 and 2000 Hz in the axial direction and at a right angle to the armature in both an energized and a de-energized state, once in each condition. (Value in the initial state)

\*3 Please contact SMC for the large flow type (Type U).

### Solenoid Specifications

Series		V114/V124	V114A/V124A	V114UT
Electrical entry		Grommet (G)/(H), L plug connector (L), M plug connector (M)		L plug connector (L), M plug connector (M)
Coil rated voltage [V]	DC	24, 12, 6, 5, 3		24
	AC 50/60 Hz	100, 110, 200, 220	—	—
Allowable voltage fluctuation		-10 to 10%*1		
Power consumption [W]	DC	Standard: 0.35 (With light: 0.4) With power-saving circuit: 0.1*2 [Inrush: 0.4, Holding: 0.1]	1 W (With light: 1.1)	With power-saving circuit: 0.35*2 [Inrush: 3.2, Holding: 0.35]
		AC	100 V	0.78 (With light: 0.81)
Apparent power [VA]	AC	110 V	0.86 (With light: 0.89)	—
		[115 V]	[0.94 (With light: 0.97)]	—
		200 V	1.18 (With light: 1.22)	—
		[230 V]	[1.42 (With light: 1.46)]	—
Surge voltage suppressor		Refer to page 12.		
Indicator light		LED		

\* The 110 VAC and the 115 VAC are interchangeable. The 220 VAC and the 230 VAC are interchangeable as well.

\*1 The allowable voltage fluctuation is -15% to +5% of the rated voltage for the 115 VAC or the 230 VAC.

\*1 For the allowable voltage fluctuation for types S, Z, and T (with power-saving circuit), please observe the following ranges because they experience voltage drops due to the internal circuit.

Types S and Z 24 VDC: -7% to +10%

12 VDC: -4% to +10%

Type T 24 VDC: -8% to +10%

12 VDC: -6% to +10%

\* Select the DC standard model or the model with power-saving circuit when the valve is to be continuously energized for long periods of time.

\*2 Refer to page 12 for details.

### Symbol

V114(A,UT)

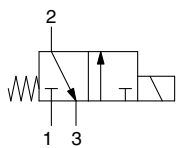

V124(A)

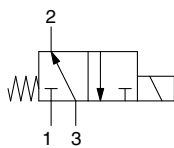

## Specifications

Valve model	Type of actuation	Type	Operating pressure range*4 [MPa]	Vacuum specification [MPa] <sup>3,4</sup>		Port size		Weight [g] <sup>*2</sup>	
				Port 1	Port 3	Port 1, 3	Port 2	Grommet	L plug connector M plug connector
V114	N.C.	Standard type	0 to 0.7	-100 kPa to 0.6	-100 kPa to 0	M5 x 0.8	M5 x 0.8	V1□4: 13 (27) V1□4A: 16 (30)	V1□4: 12 (26) V1□4A: 15 (29) V114UT: 15 (29)
V114A	N.C.	Large flow type (Type A)	0 to 0.7	-100 kPa to 0.6	-100 kPa to 0	M5 x 0.8	M5 x 0.8		
V114UT	N.C.	Large flow type (Type U)	0 to 0.6	-100 kPa to 0.5	-100 kPa to 0	M5 x 0.8	M5 x 0.8		
V124*1	N.O.	Standard type	0 to 0.7	-100 kPa to 0	-100 kPa to 0.6	M5 x 0.8	M5 x 0.8		
V124A*1	N.O.	Large flow type (Type A)	0 to 0.7	-100 kPa to 0	-100 kPa to 0.6	M5 x 0.8	M5 x 0.8		

Valve model	Flow rate characteristics					
	1 → 2 [3 → 2*3]			2 → 3 [2 → 1*3]		
	C [dm <sup>3</sup> /(s·bar)]	b	Cv	C [dm <sup>3</sup> /(s·bar)]	b	Cv
V114	0.037	0.11	0.008	0.054	0.35	0.015
V114A	0.076	0.07	0.016	0.099	0.23	0.024
V114UT	0.16	0.18	0.038	0.15	0.34	0.041
V124*1	0.054	0.35	0.015	0.037	0.11	0.008
V124A*1	0.099	0.23	0.024	0.076	0.07	0.016

\*1 For both the V124 and the V124A, pressure from port 3 and exhaust from port 1.

\*2 The values shown in ( ) are for values with sub-plate.

\*3 For the V124(A)

\*4 Please note that, if the difference between the inlet side and the outlet side is extremely low (0.001 MPa or less as a guide), air may not be output or the flow rate may deteriorate excessively due to the quality of the lubricant and air in the solenoid valve (mixing in of the drain, etc.).

## Construction

### V114(A, UT)

### V124(A)

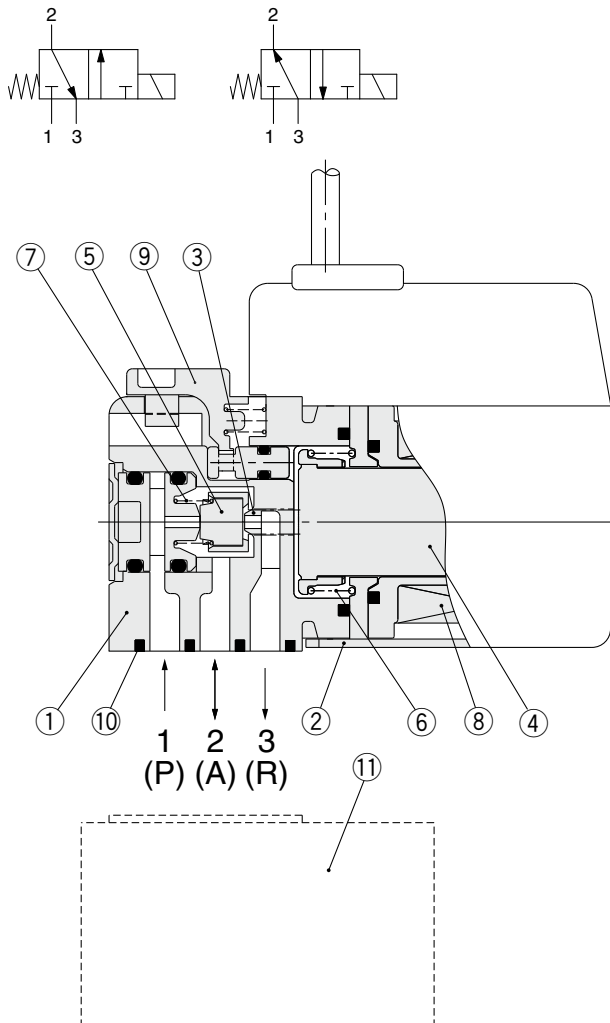

### Component Parts

No.	Description	Material
1	Body	Resin
2	Cover	Stainless steel
3	Push rod	Resin
4	Armature assembly	Stainless steel, Resin
5	Poppet	FKM, HNBR
6	Return spring	Stainless steel
7	Poppet spring	Stainless steel
8	Coil assembly	—
9	Manual override	Resin

### Replacement Parts

No.	Description	Part no.	Material	Note
10	Gasket assembly	V100-31-1A	FKM, Steel	Gasket, 2 screws
11	Sub-plate	V100-74-1	Aluminum die-cast	—

### How to Order Connector Assembly

For DC: **SY100-30-4A** - □

For 100 VAC: **SY100-30-1A** - □

For 200 VAC: **SY100-30-2A** - □

For other voltages of AC: **SY100-30-3A** - □

Without lead wire: **SY100-30-A** (with connector and 2 sockets)

● Lead wire length

Nil	300 mm
6	600 mm
10	1000 mm
15	1500 mm
20	2000 mm
25	2500 mm
30	3000 mm
50	5000 mm

## How to Order

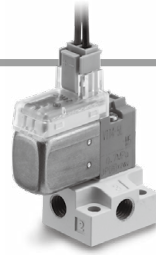

### Standard type

#### Base mounted

Sub-plate type,  
For manifold type S41

V1 **1** 4   - **5** **M**     -  

#### Type of actuation

<b>1</b>	Normally closed
<b>2</b>	Normally open

#### Coil type

<b>Nil</b>	0.35 W
<b>T</b>	0.1 W (with power-saving circuit) (24 VDC, 12 VDC only)

\* All the types with power-saving circuit are with light and surge voltage suppressor "Z."

#### Rated voltage

For DC		CE-compliant
<b>5</b>	24 VDC	●
<b>6</b>	12 VDC	●
<b>V</b>	6 VDC	●
<b>S</b>	5 VDC	●
<b>R</b>	3 VDC	●

For AC (50/60 Hz)		CE-compliant
<b>1</b>	100 VAC	—
<b>2</b>	200 VAC	—
<b>3</b>	110 VAC [115 VAC]	—
<b>4</b>	220 VAC [230 VAC]	—

#### Electrical entry

24 V, 12 V, 6 V, 5 V, 3 VDC/100 V, 110 V, 200 V, 220 VAC			
Grommet	L plug connector	M plug connector	
<b>G</b> : 300 mm lead wire	<b>L</b> : With 300 mm lead wire	<b>M</b> : With 300 mm lead wire	<b>MN</b> : Without lead wire
<b>H</b> : 600 mm lead wire			
	<b>LN</b> : Without lead wire	<b>LO</b> : Without connector	<b>MO</b> : Without connector

- \* LN and MN types are with 2 sockets.
- \* Refer to page 11 for the different lead wire lengths of L and M plug connectors.
- \* Refer to page 13 for the connector assembly with a dustproof cover for L and M plug connectors.

#### Port size

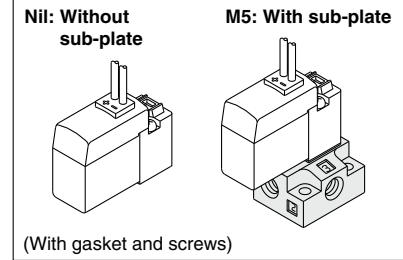

#### Manual override

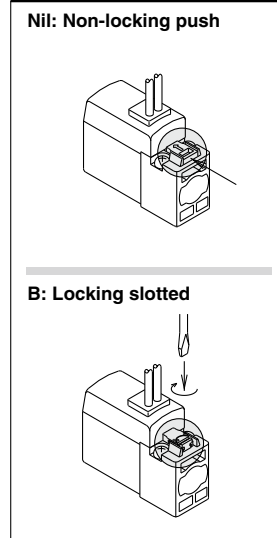

#### Light/surge voltage suppressor

<b>Nil</b>	Without light/surge voltage suppressor	For DC, AC
<b>S</b>	With surge voltage suppressor	For DC
<b>Z</b>	With light/surge voltage suppressor	For DC, AC
<b>R</b>	With surge voltage suppressor (Non-polar)	For DC
<b>U</b>	With light/surge voltage suppressor (Non-polar)	

\* Only "Z" is available for the models with power-saving circuit.



## How to Order

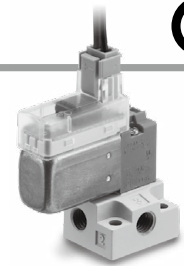

### Large flow type (Type A)

**Base mounted**

Sub-plate type,  
For manifold type S41

V1 **1** 4 A — **5** M — — —

#### Type of actuation

1	Normally closed
2	Normally open

#### Large flow type (Type A)

#### Rated voltage

For DC		CE-compliant
5	24 VDC	●
6	12 VDC	●
V	6 VDC	●
S	5 VDC	●
R	3 VDC	●

#### Electrical entry

24 V, 12 V, 6 V, 5 V, 3 VDC			
Grommet	L plug connector	M plug connector	
G: 300 mm lead wire	L: With 300 mm lead wire	M: With 300 mm lead wire	MN: Without lead wire
H: 600 mm lead wire			
	LN: Without lead wire	LO: Without connector	MO: Without connector

#### Port size

Nil: Without sub-plate      M5: With sub-plate

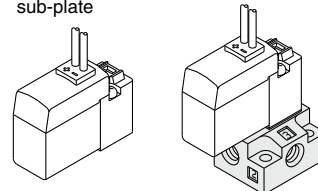

(With gasket and screws)

#### Manual override

Nil: Non-locking push

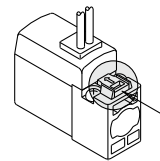

B: Locking slotted

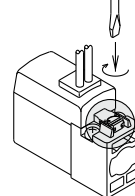

#### Light/surge voltage suppressor

Nil	Without light/surge voltage suppressor	For DC
R	With surge voltage suppressor	
U	With light/surge voltage suppressor	

\* LN and MN types are with 2 sockets.

\* Refer to page 11 for the different lead wire lengths of L and M plug connectors.

\* Refer to page 13 for the connector assembly with a dustproof cover for L and M plug connectors.

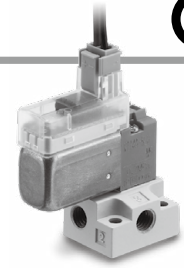

### Large flow type (Type U)

**Base mounted**

Sub-plate type,  
For manifold type S41

V1 1 4 UT - 5 M Z [ ] - [ ]

● **Type of actuation**

1 Normally closed

● **Large flow type (Type U)**

● **Coil type**

T 0.35 W (With power-saving circuit)

● **Rated voltage**

For DC		CE-compliant
5	24 VDC	●

● **Electrical entry**

24 VDC		
L plug connector	M plug connector	
L: With 300 mm lead wire	M: With 300 mm lead wire	MN: Without lead wire
LN: Without lead wire	LO: Without connector	MO: Without connector

● **Port size**

Nil: Without sub-plate    M5: With sub-plate

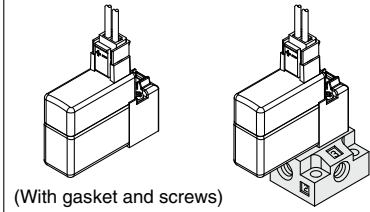

● **Manual override**

Nil: Non-locking push

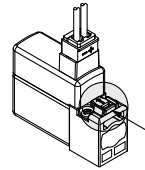

B: Locking slotted

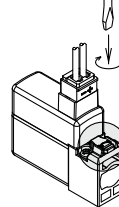

● **Light/surge voltage suppressor**

Z With light/surge voltage suppressor

\* LN and MN types are with 2 sockets.

\* Refer to page 11 for the different lead wire lengths of L and M plug connectors.

\* Refer to page 13 for the connector assembly with a dustproof cover for L and M plug connectors.

\* [ ]: AC  
 < >: Values for the large flow type (Type A, UT)

## Base Mounted (With sub-plate)

Grommet (G), (H): V1<sup>1</sup>/<sub>2</sub>4(A)-□<sup>G</sup>□□-M5

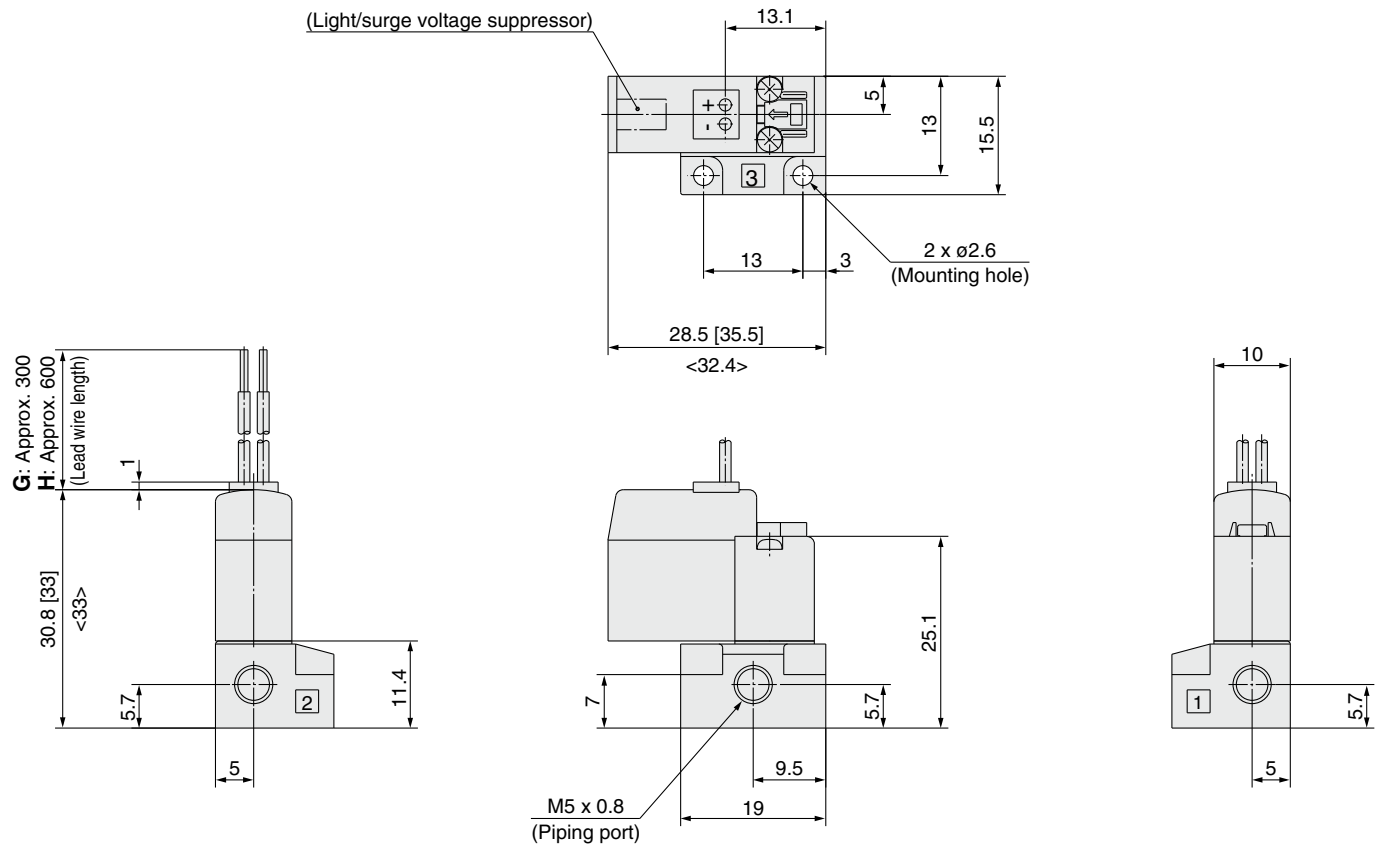

L plug connector (L): V1<sup>1</sup>/<sub>2</sub>4(A, UT)-□L□□-M5

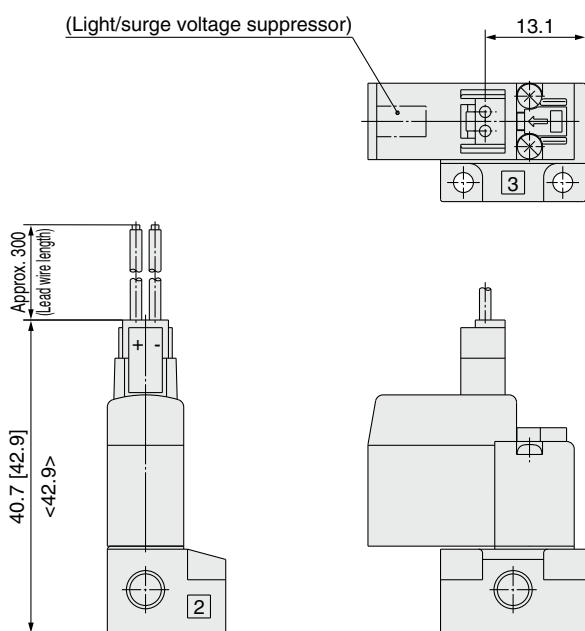

\* Other dimensions are the same as those of the grommet type.

M plug connector (M): V1<sup>1</sup>/<sub>2</sub>4(A, UT)-□M□□-M5

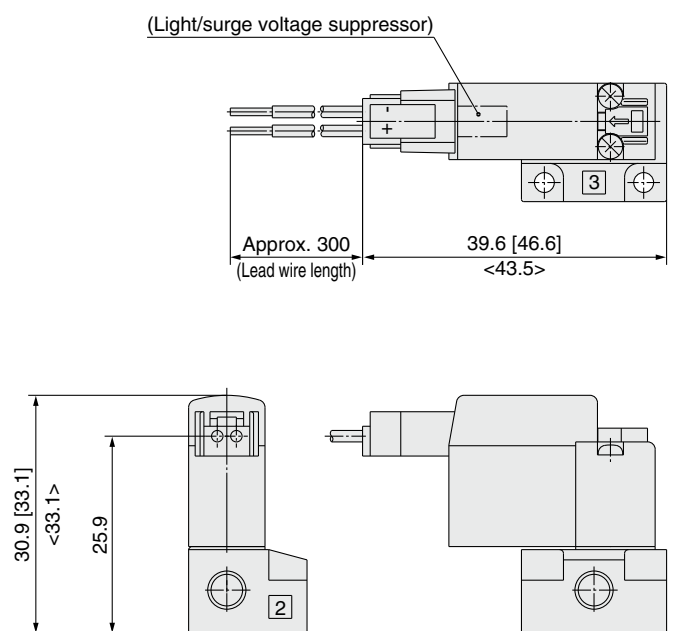

\* Other dimensions are the same as those of the grommet type.

# 3-Port Solenoid Valve/V100 Series Manifold Specifications

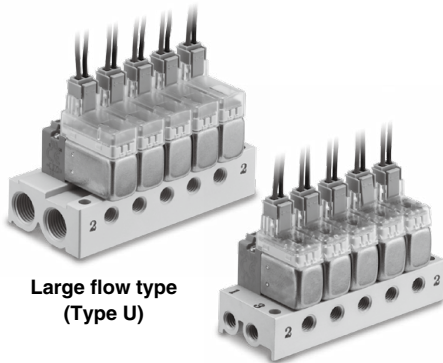

Large flow type  
(Type U)

Standard type /  
Large flow type  
(Type A)

## Manifold Specifications

Model		Type S41	
Manifold		Single base type/B mount	
P (SUP)/R (EXH) type		Common SUP/Common EXH	
Valve stations		2 to 20 stations	
Output port porting specifications	Location	Base	
	Direction	Side	
Port size	Type VV100-S41	Port 1, 2, 3	M5 x 0.8
	Type VV100U-S41	Port 1, 3	1/8
		Port 2	M5 x 0.8

- \* The V114(A) and the V124(A) cannot be mounted to the same manifold.
- \* For the V124(A), pressure from port 3 and exhaust from port 1.

## Flow Rate Characteristics\*1

Manifold		Port size	Flow rate characteristics					
			Port 1, 2, 3	1 → 2 [3 → 2*1]			2 → 3 [2 → 1*1]	
				C [dm <sup>3</sup> /(s·bar)]	b	Cv	C [dm <sup>3</sup> /(s·bar)]	b
Type VV100-S41	V114	M5 x 0.8	0.032	0.13	0.007	0.050	0.26	0.012
	V114A		0.070	0.10	0.016	0.085	0.16	0.020
	V124		0.050	0.26	0.012	0.032	0.13	0.007
	V124A		0.085	0.16	0.020	0.070	0.10	0.016
Type VV100U-S41	V114UT	1, 3: 1/8 2: M5 x 0.8	0.14	0.12	0.034	0.15	0.26	0.036

\* Values when mounted on the manifold base (5 stations)

\*1 For the V124(A)

## How to Order Valve Manifold Assembly (Example)

### Ordering example

Valve (N.C.)  
V114-5GZ

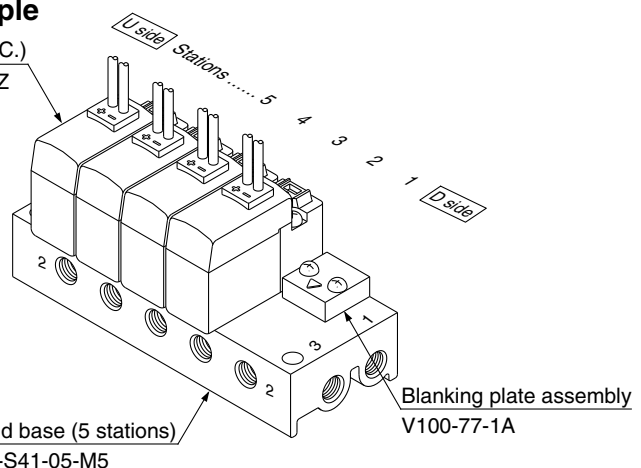

VV100-S41-05-M5 ..... 1 set (Type S41, 5 station manifold base part no.)

\*V100-77-1A ..... 1 set (Blanking plate assembly part no.)

\*V114-5GZ ..... 4 sets (Valve)

↳ The asterisk denotes the symbol for the assembly.  
Prefix it to the part nos. of the solenoid valve, etc.

Beneath the manifold base part number, enter the valve and option part numbers to be mounted.





## Common SUP/Common EXH

### Type S41

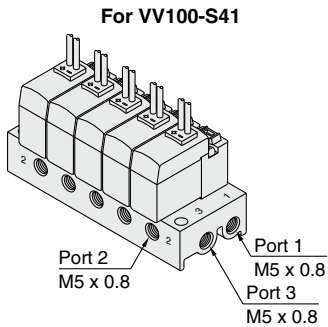

#### How to Order

Standard type / Large flow type (Type A)

**VV100 – S41 – 05 – M5**

Stations	
02	2 stations
⋮	⋮
20	20 stations

Port 2 size	
M5	M5 x 0.8

Applicable solenoid valve\*1

V114-□□□□  
V114A-□□□□  
V124-□□□□  
V124A-□□□□

Applicable blanking plate assembly  
V100-77-1A

- \*1 The V114(A) and the V124(A) cannot be mounted to the same manifold.
- \* For 2 to 9 stations, the port 1 [for the V114(A)] or port 3 [for the V124(A)] entry is only available on the U side (a plug is mounted on the D side). For 10 to 20 stations, it is available on both sides (with no plug mounted).

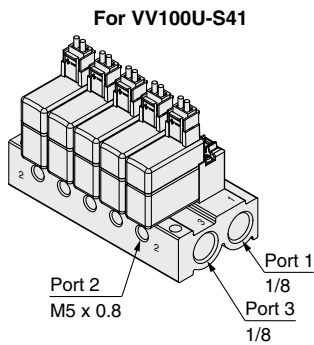

Large flow type (Type U)

**VV100U – S41 – 05 D – 01**

Stations	
02	2 stations
⋮	⋮
20	20 stations

Port 1 entry	
U	U side*2
D	D side*2
B	Both sides

Port 1/3 size	
Nll	Rc1/8
F	G1/8
N	NPT1/8

Applicable solenoid valve

V114UT-5□□

Applicable blanking plate assembly  
V100-77-1A

- \*2 Plugs are mounted on the opposite side of the selected ports.

## Gasket Assembly

Part No.: V100-31-1A

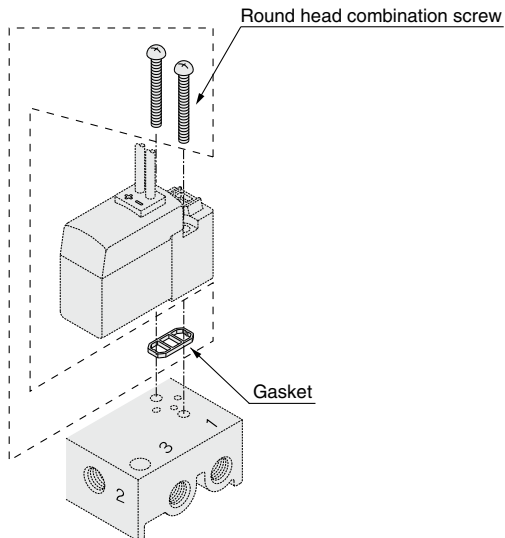

Applicable base  
· Sub-plate  
· Type VV100(U)-S41 manifold base

## Blanking Plate Assembly

Part No.: V100-77-1A

Have the notch mark on the blanking plate face the port 2 side when assembling.

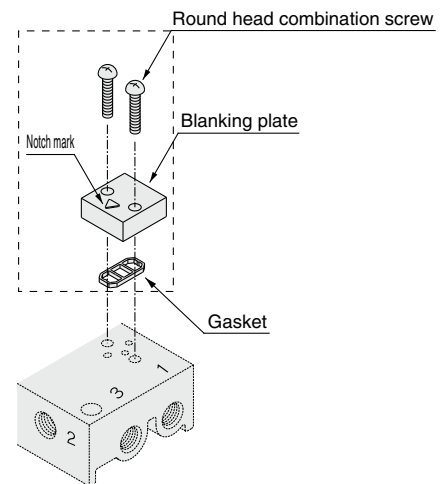

Applicable base  
· Sub-plate  
· Type VV100(U)-S41 manifold base

### Caution

Mounting screw tightening torque **M2: 0.12 N·m**

# V100 Series

## Type S41 Manifold: Side Ported/VV100-S41-Stations-M5

### Grommet (G), (H)

\* [ ]: AC  
 < >: Values for the large flow type (Type A)

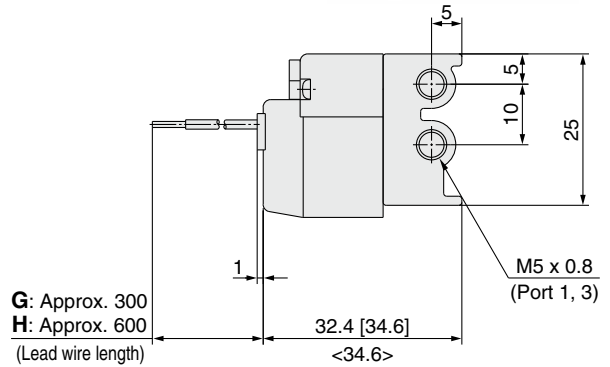
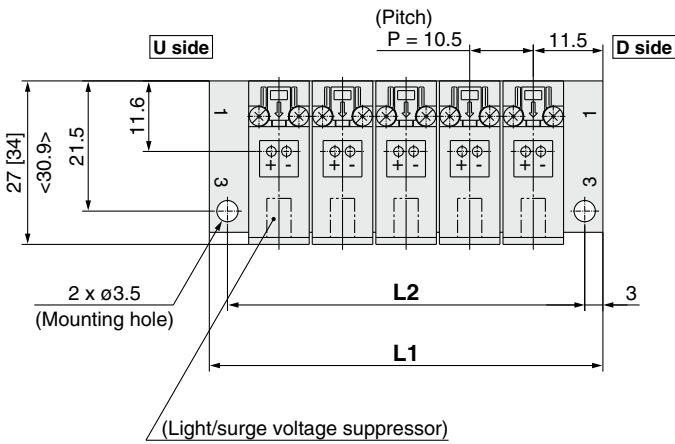
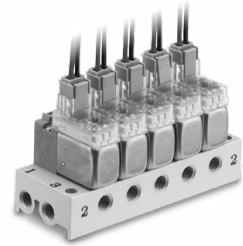

(n station) ----- (1 station)

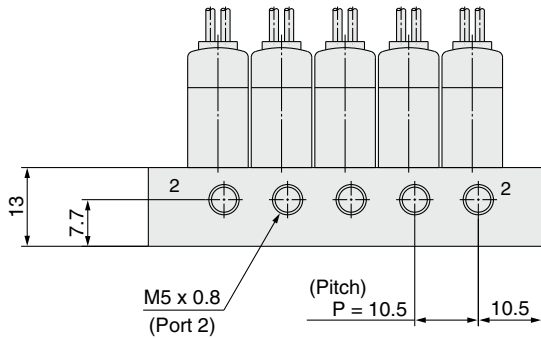

### L plug connector (L)

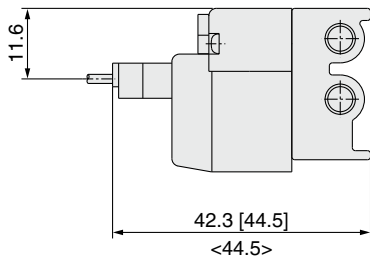

\* Other dimensions are the same as those of the grommet type.

### M plug connector (M)

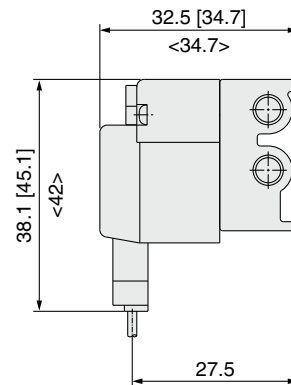

\* Other dimensions are the same as those of the grommet type.

Station	2 stations	3	4	5	6	7	8	9	10	11	12	13	14	15	16	17	18	19	20 stations
L1	33.5	44	54.5	65	75.5	86	96.5	107	117.5	128	138.5	149	159.5	170	180.5	191	201.5	212	222.5
L2	27.5	38	48.5	59	69.5	80	90.5	101	111.5	122	132.5	143	153.5	164	174.5	185	195.5	206	216.5

## Type S41 Manifold: Side Ported/VV100U-S41- Stations -01 □

### L plug connector (L)

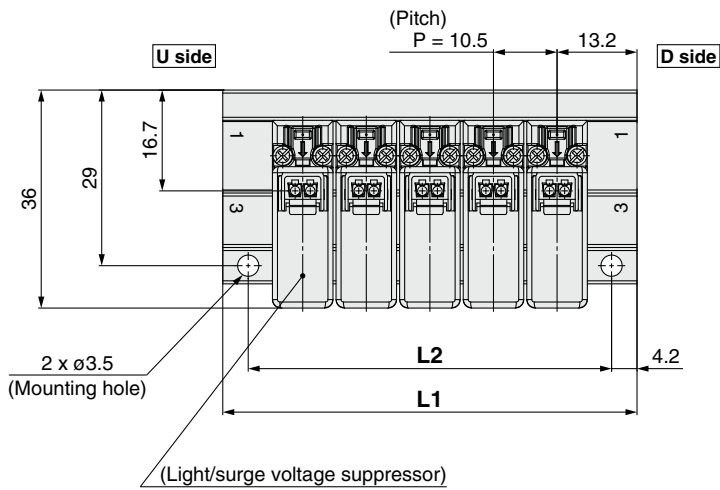
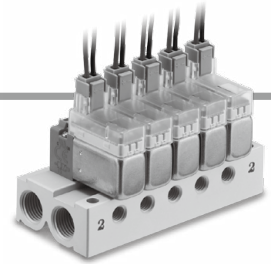

### M plug connector (M)

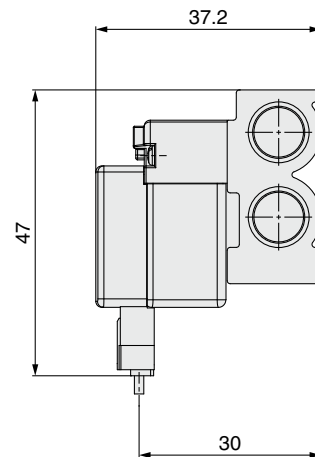
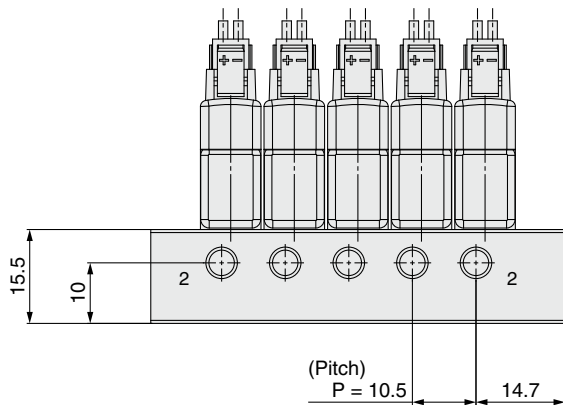

\* Other dimensions are the same as those of the L plug connector type.

Station	2 stations	3	4	5	6	7	8	9	10	11	12	13	14	15	16	17	18	19	20 stations
<b>L1</b>	36.9	47.4	57.9	68.4	78.9	89.4	99.9	110.4	120.9	131.4	141.9	152.4	162.9	173.4	183.9	194.4	204.9	215.4	225.9
<b>L2</b>	28.5	39	49.5	60	70.5	81	91.5	102	112.5	123	133.5	144	154.5	165	175.5	186	196.5	207	217.5



# V100 Series

## Specific Product Precautions 1

Be sure to read this before handling the products. Refer to the back cover for safety instructions. For 3/4/5-port solenoid valve precautions, refer to the "Handling Precautions for SMC Products" and the "Operation Manual" on the SMC website.

### Manual Override Operation

#### Warning

Since connected equipment will be actuated when the manual override is operated, first confirm that conditions are safe.

#### Non-locking push type [Standard]

Press in the direction of the arrow.

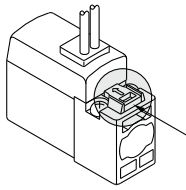

#### Locking slotted type [Type B]

Turn in the direction of the arrow.

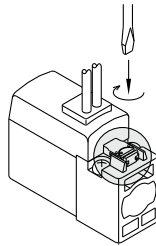

#### Caution

When operating with a screwdriver, turn it gently using a watchmakers' screwdriver. [Torque: Less than 0.1 N·m]

### How to Use Plug Connector

#### Caution

#### 1. Connector attachment/detachment

- To attach a connector, hold the lever and connector unit between your fingers and insert straight onto the pins of the solenoid valve so that the lever's pawl is pushed into the groove and locks.
- To detach a connector, remove the pawl from the groove by pushing the lever downward with your thumb, and pull the connector straight out.

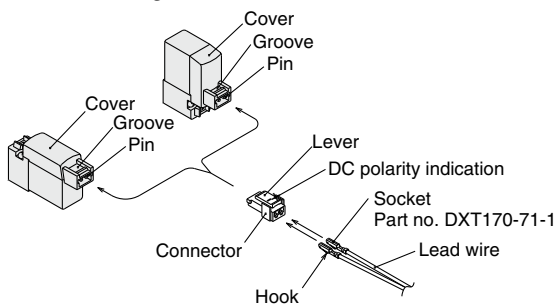

#### 2. Crimping of lead wires and sockets

Peel 3.2 to 3.7 mm of the tip of the lead wire, enter the core wires neatly into a socket and crimp it with a special crimp tool. Be careful so that the cover of the lead wire does not enter into the crimping part.

Use special tool when crimping. (Please contact SMC for the dedicated crimping tools.)

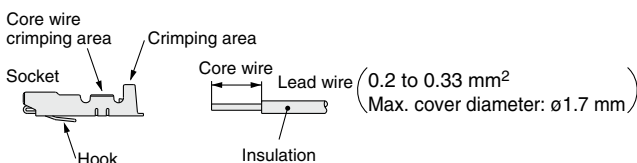

### How to Use Plug Connector

#### Caution

#### 3. Lead wires with sockets attachment/detachment

##### Attachment

Insert the sockets into the square holes of the connector (with ⊕, and ⊖ indication), and continue to push the sockets all the way in until they lock by hooking into the seats in the connector. (When they are pushed in, their hooks open, and they are locked automatically.) Next, confirm that they are locked by pulling lightly on the lead wires.

##### Detachment

To detach a socket from a connector, pull out the lead wire while pressing the socket's hook with a stick having a thin tip (approx. 1 mm). If the socket is used again, spread the hook outward.

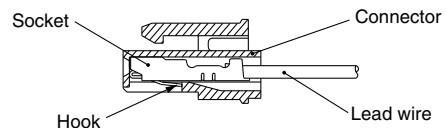

### Plug Connector Lead Wire Length

Plug connector lead wires have a standard length of 300 mm, however, the following lengths are also available.

#### Connector Assembly Part Nos.

For DC: **SY100-30-4A** - [Socket]

For 100 VAC: **SY100-30-1A** - [Socket]

For 200 VAC: **SY100-30-2A** - [Socket]

For other voltages of AC: **SY100-30-3A** - [Socket]

Without lead wire: **SY100-30-A**  
(with connector and 2 sockets)

#### How to Order

Include the connector assembly part number together with the part number for the plug connector's solenoid valve without connector.  
<Example> Lead wire length 2000 mm

For DC: **V114-5LO**      For AC: **V114A-1LO**  
**SY100-30-4A-20**      **SY100-30-1A-20**

#### Lead wire length

Nil	300 mm
6	600 mm
10	1000 mm
15	1500 mm
20	2000 mm
25	2500 mm
30	3000 mm
50	5000 mm

### SMC's Lead Wire Specifications

Cover diameter: 1.55 mm

Conductor area: 0.3 mm<sup>2</sup> (AWG22 equivalent)



# V100 Series Specific Product Precautions 2

Be sure to read this before handling the products. Refer to the back cover for safety instructions. For 3/4/5-port solenoid valve precautions, refer to the "Handling Precautions for SMC Products" and the "Operation Manual" on the SMC website.

## Surge Voltage Suppressor

### <For DC> Grommet, L and M Plug Connector

#### Standard type (with polarity) With surge voltage suppressor (□S)

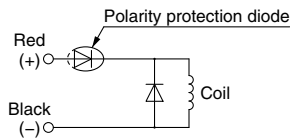

#### With light/surge voltage suppressor (□Z)

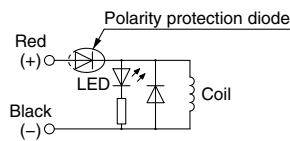

#### Non-polar type With surge voltage suppressor (□R)

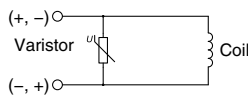

#### With light/surge voltage suppressor (□U)

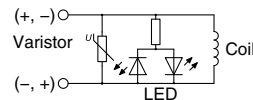

- Please connect correctly the lead wires to + (positive) and - (negative) indications on the connector.
- For DC voltages other than 12, 24 VDC, incorrect wiring will cause damage to the surge voltage suppressor circuit since a diode to prevent reverse current is not provided. (Wrong polarity will cause trouble.)
- When wiring is done at the factory, positive (+) is red and negative (-) is black.

#### With power-saving circuit

Power consumption has been reduced to approx. 1/4 (approx. 1/9 for the large flow type (Type U)) of that of the standard model by eliminating the need for electrical current for holding. (Effective after more than 62 ms (23 ms for the large flow type (Type U)) energized and 24 VDC rated voltage applied.)

#### Electric circuit (with power-saving circuit)

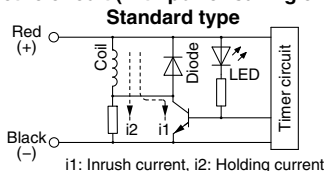

#### Large flow type (Type U)

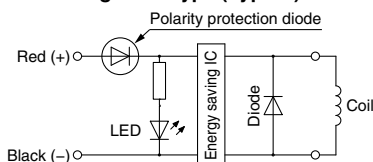

### Operating Principle

The electrical circuit as shown in the left figure, allows reduced holding current consumption and measures power saving. Refer to electrical power waveform as shown below.

- Please be careful not to reverse the polarity, since a diode to prevent the reversed current is not provided for the model with power-saving circuit (Standard type).

#### <Electric waveform in power-saving, for the V1<sub>2</sub>4T>

( ): Values of the V114UT

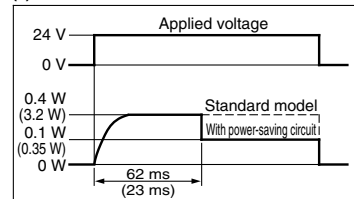

### <For AC> Grommet, L and M Plug Connector

#### With light (□Z)

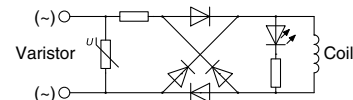

## ⚠ Caution

For the varistor surge voltage suppressor for DC, please note that the surge voltage will be suppressed on the controller side as there will be residual voltage according to the protective element and rated voltage. Moreover, the residual voltage of the diode is approx. 1 V.



## V100 Series

# Specific Product Precautions 3

Be sure to read this before handling the products. Refer to the back cover for safety instructions. For 3/4/5-port solenoid valve precautions, refer to the “Handling Precautions for SMC Products” and the “Operation Manual” on the SMC website.

### Connector Assembly with Cover

Connector assembly with protective cover enhances dust protection

- Effective in preventing possible short circuit problems due to contaminants in contact with connector section.
- Chloroprene rubber for electrical use, which provides outstanding weather resistance and electrical insulation, is used for the cover material. However, be careful not to allow contact with cutting oil, etc.
- Round cord provides neat appearance.

### How to Order

SY100-68-A-

• Lead wire length (L)

Nil	300 mm
6	600 mm
10	1000 mm
15	1500 mm
20	2000 mm
25	2500 mm
30	3000 mm
50	5000 mm

### Connector Assembly with Cover / Dimensions

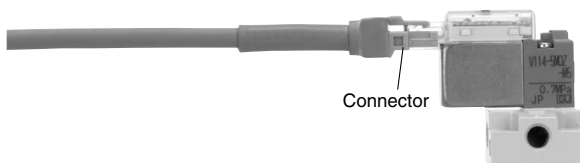
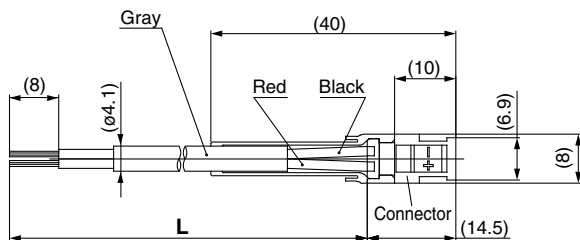

### • How to Order

Indicate part number of connector assembly with cover in addition to the solenoid valve part number without connector of the plug connector.

<Example 1> Lead wire length: 2000 mm

**V114-5LOZ-M5**

**SY100-68-A-20**

<Example 2> Lead wire length: 300 mm (Standard)

**V114-5LPZ-M5**

Symbol for a connector assembly with cover

- \* No need to indicate the part number for a connector assembly with cover in this case.

## Safety Instructions

These safety instructions are intended to prevent hazardous situations and/or equipment damage. These instructions indicate the level of potential hazard with the labels of “**Caution**,” “**Warning**” or “**Danger**.” They are all important notes for safety and must be followed in addition to International Standards (ISO/IEC)\*1), and other safety regulations.

 **Caution:** **Caution** indicates a hazard with a low level of risk which, if not avoided, could result in minor or moderate injury.

 **Warning:** **Warning** indicates a hazard with a medium level of risk which, if not avoided, could result in death or serious injury.

 **Danger :** **Danger** indicates a hazard with a high level of risk which, if not avoided, will result in death or serious injury.

\*1) ISO 4414: Pneumatic fluid power – General rules relating to systems.  
ISO 4413: Hydraulic fluid power – General rules relating to systems.  
IEC 60204-1: Safety of machinery – Electrical equipment of machines.  
(Part 1: General requirements)  
ISO 10218-1: Manipulating industrial robots – Safety.  
etc.

### Warning

#### 1. The compatibility of the product is the responsibility of the person who designs the equipment or decides its specifications.

Since the product specified here is used under various operating conditions, its compatibility with specific equipment must be decided by the person who designs the equipment or decides its specifications based on necessary analysis and test results. The expected performance and safety assurance of the equipment will be the responsibility of the person who has determined its compatibility with the product. This person should also continuously review all specifications of the product referring to its latest catalog information, with a view to giving due consideration to any possibility of equipment failure when configuring the equipment.

#### 2. Only personnel with appropriate training should operate machinery and equipment.

The product specified here may become unsafe if handled incorrectly. The assembly, operation and maintenance of machines or equipment including our products must be performed by an operator who is appropriately trained and experienced.

#### 3. Do not service or attempt to remove product and machinery/equipment until safety is confirmed.

1. The inspection and maintenance of machinery/equipment should only be performed after measures to prevent falling or runaway of the driven objects have been confirmed.
2. When the product is to be removed, confirm that the safety measures as mentioned above are implemented and the power from any appropriate source is cut, and read and understand the specific product precautions of all relevant products carefully.
3. Before machinery/equipment is restarted, take measures to prevent unexpected operation and malfunction.

#### 4. Contact SMC beforehand and take special consideration of safety measures if the product is to be used in any of the following conditions.

1. Conditions and environments outside of the given specifications, or use outdoors or in a place exposed to direct sunlight.
2. Installation on equipment in conjunction with atomic energy, railways, air navigation, space, shipping, vehicles, military, medical treatment, combustion and recreation, or equipment in contact with food and beverages, emergency stop circuits, clutch and brake circuits in press applications, safety equipment or other applications unsuitable for the standard specifications described in the product catalog.
3. An application which could have negative effects on people, property, or animals requiring special safety analysis.
4. Use in an interlock circuit, which requires the provision of double interlock for possible failure by using a mechanical protective function, and periodical checks to confirm proper operation.

### Caution

#### 1. The product is provided for use in manufacturing industries.

The product herein described is basically provided for peaceful use in manufacturing industries.  
If considering using the product in other industries, consult SMC beforehand and exchange specifications or a contract if necessary.  
If anything is unclear, contact your nearest sales branch.

### Limited warranty and Disclaimer/ Compliance Requirements

The product used is subject to the following “Limited warranty and Disclaimer” and “Compliance Requirements”.

Read and accept them before using the product.

#### Limited warranty and Disclaimer

1. The warranty period of the product is 1 year in service or 1.5 years after the product is delivered, whichever is first.\*2)  
Also, the product may have specified durability, running distance or replacement parts. Please consult your nearest sales branch.
2. For any failure or damage reported within the warranty period which is clearly our responsibility, a replacement product or necessary parts will be provided.  
This limited warranty applies only to our product independently, and not to any other damage incurred due to the failure of the product.
3. Prior to using SMC products, please read and understand the warranty terms and disclaimers noted in the specified catalog for the particular products.

##### \*2) Vacuum pads are excluded from this 1 year warranty.

A vacuum pad is a consumable part, so it is warranted for a year after it is delivered.  
Also, even within the warranty period, the wear of a product due to the use of the vacuum pad or failure due to the deterioration of rubber material are not covered by the limited warranty.

#### Compliance Requirements

1. The use of SMC products with production equipment for the manufacture of weapons of mass destruction (WMD) or any other weapon is strictly prohibited.
2. The exports of SMC products or technology from one country to another are governed by the relevant security laws and regulations of the countries involved in the transaction. Prior to the shipment of a SMC product to another country, assure that all local rules governing that export are known and followed.

### Caution

#### SMC products are not intended for use as instruments for legal metrology.

Measurement instruments that SMC manufactures or sells have not been qualified by type approval tests relevant to the metrology (measurement) laws of each country. Therefore, SMC products cannot be used for business or certification ordained by the metrology (measurement) laws of each country.

#### Revision History

Edition B	* The AC specification has been changed.	JO
Edition C	* A large flow type (Type U) has been added.	ZY

## Safety Instructions

Be sure to read the “Handling Precautions for SMC Products” (M-E03-3) and “Operation Manual” before use.