

Rotary Table/ Rack & Pinion Type

Size: 10, 20, 30, 50

RoHS

New

- A bumper (cushion) has been added.



Height

Max. **28%** reduction*¹
54 mm → **39 mm**



Weight

Max. **28%** reduction*¹
940 g → **680 g**

*¹ Compared with the existing model (MSQ20)

Enlarged center
hole diameter for
piping

Ø9 mm → **Ø12 mm**

Compared with the existing model
(MSQ20)



MSQ Series

SMC

CAT.ES20-256B

Compact and lightweight

Reduced Height

Size	New MSQ (H1)	MSQ (H2)	Reduction rate [%]
10	35.5	47	24
20	39	54	28
30	46	57	19
50	51.5	66	22

Reduced Weight

Size	New MSQ	MSQ	Reduction rate [%]
10	375	500	25
20	680	940	28
30	930	1230	24
50	1500	1990	25

* For the MSQ□A



High durability and high accuracy

The large rolling bearing provides high durability and high accuracy.

Large rolling bearing

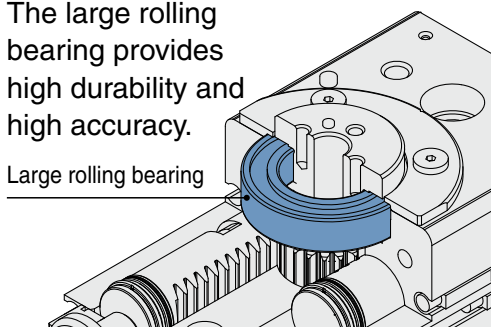

Improved workability

The end ports and the angle adjustment mechanisms are located on the same surface.

End ports

Angle adjustment mechanism (Cushion pad, Bumper)

Side port (Same for the opposite side, With plug)



3 types of cushions are available.

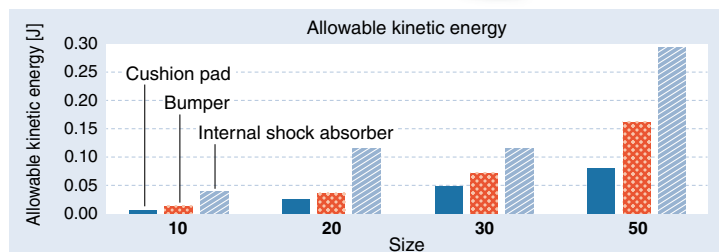
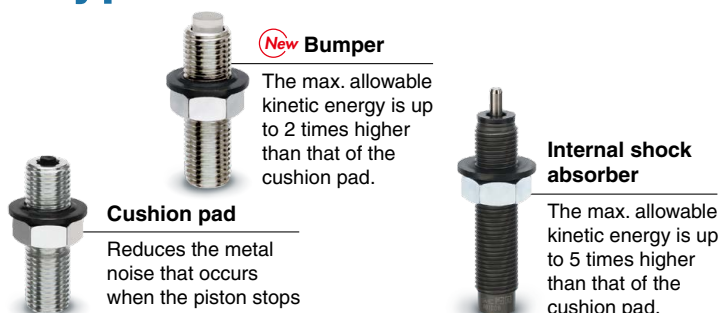

Internal shock absorber



Cushion pad, bumper construction

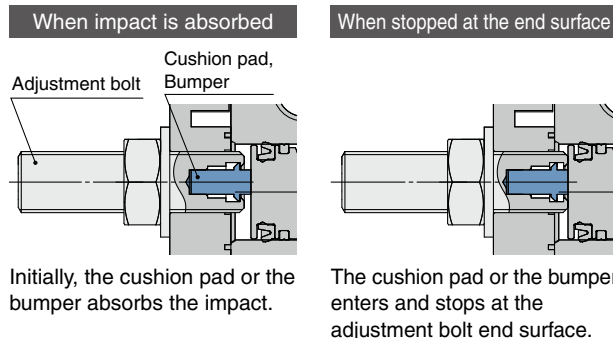

Enlarged center hole diameter for piping

Size	New MSQ	MSQ
10	ø7	ø6
20	ø12	ø9
30	ø13	ø12
50	ø14	ø13

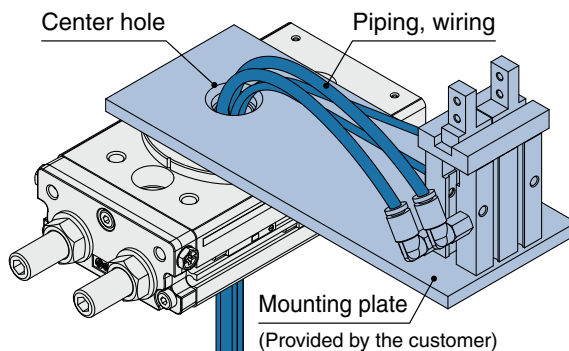
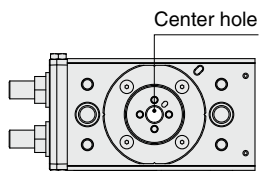

The adjustable rotation time range is expanded.

Can be used at lower speeds compared with the existing model

New MSQ 0.2 to 2.0 s/90°
MSQ 0.2 to 1.0 s/90°

* For the MSQ□^A

An interchangeable table and plate are available. (Made to order)

The new model is only fully interchangeable with the existing model when the optional interchangeable plate and table are utilized.

* For details, refer to page 23.

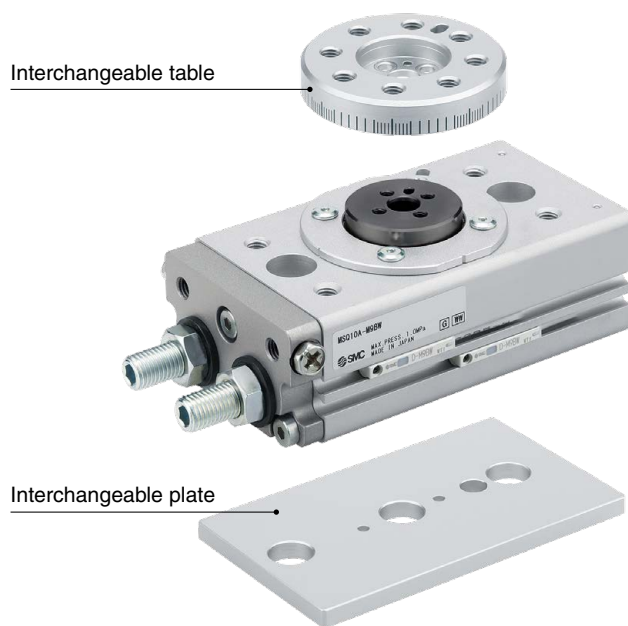

Compact auto switches are mountable.



Select from 3 mounting methods.

Mounting dimensions are interchangeable with the existing MSQ series model. For mounting, refer to "Mounting" on page 25.

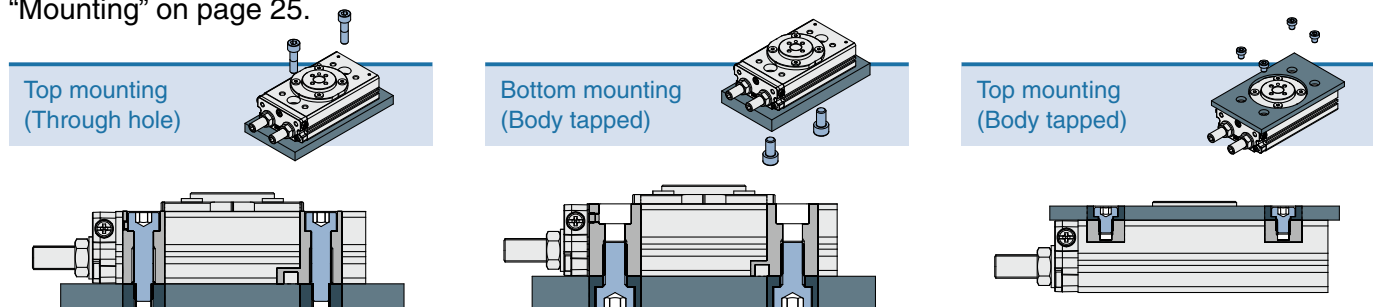

CONTENTS

Rotary Table/Rack & Pinion Type *MSQ Series*



Model Selection	p. 4
How to Order	p. 15
Specifications	p. 16
Allowable Kinetic Energy and Rotation Time Adjustment Range	p. 16
Weight	p. 16
Rotation Direction and Rotating Angle	p. 17
Rotating Angle Range Examples	p. 17
Table Displacement (Reference values)	p. 18
Deflection Accuracy: Displacement at 180° Rotation (Guide)	p. 18
Working Principle	p. 18
Construction	p. 19
Dimensions	p. 20
Auto Switch Mounting	p. 21
Prior to Use	p. 22
● Made to Order	
With Interchangeable Table and Plate/ MSQ□-A	p. 23
With Interchangeable Table/ MSQ□-B	p. 23
With Interchangeable Plate/ MSQ□-C	p. 23
Specific Product Precautions	p. 24

Rotary Actuator Model Selection

CONTENTS

1	Calculation of Moment of Inertia	p. 6
	● Equation Table of Moment of Inertia	p. 6
	● Calculation Example of Moment of Inertia	p. 7
	● Graph for Calculating the Moment of Inertia	p. 9
2	Calculation of Required Torque	p. 10
	● Load Type	p. 10
	● Effective Torque	p. 10
3	Confirmation of Rotation Time	p. 10
4	Calculation of Kinetic Energy	p. 11
	● Allowable Kinetic Energy and Rotation Time Adjustment Range	p. 11
	● Moment of Inertia and Rotation Time	p. 12
5	Confirmation of Allowable Load	p. 13
6	Calculation of Air Consumption and Required Air Flow Capacity	p. 13
	● Air Consumption Calculation Graph	p. 14

Rotary Actuator Model Selection

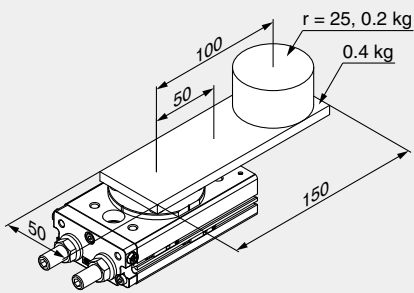
Selection Procedures	Note	Selection Example
<p>◆ List of Operating Conditions</p> <ul style="list-style-type: none"> Initially selected models Operating pressure [MPa] Mounting orientation Load type <ul style="list-style-type: none"> Static load Resistance load Inertial load Load dimensions [m] Load mass [kg] Rotation time [s] Rotating angle [rad] 	<p>Refer to page 10 for the load type.</p> <p>The unit for the rotating angle is radian. $180^\circ = \pi \text{ rad}$ $90^\circ = \pi/2 \text{ rad}$</p>	 <p>Initially selected model: MSQ30A Operating pressure: 0.3 MPa Mounting orientation: Vertical Load type: Inertial load Rotation time: $t = 1.5 \text{ s}$ Rotating angle: $\theta = \pi \text{ rad (180}^\circ)$</p>
1 Calculation of Moment of Inertia		
<p>Calculate the inertial moment of load. \Rightarrow p. 6</p>	<p>Loads are generated from multiple parts. The inertial moment of each load is calculated, and then totaled.</p>	<p>Inertial moment of load 1: I_1 $I_1 = 0.4 \times \frac{0.15^2 + 0.05^2}{12} + 0.4 \times 0.05^2 = 0.001833$</p> <p>Inertial moment of load 2: I_2 $I_2 = 0.2 \times \frac{0.025^2}{2} + 0.2 \times 0.1^2 = 0.002063$</p> <p>Total inertial moment: I $I = I_1 + I_2 = 0.003896 \text{ [kg}\cdot\text{m}^2]$</p>
2 Calculation of Required Torque		
<p>Calculate the required torque for each load type and confirm whether the values fall in the effective torque range.</p> <ul style="list-style-type: none"> Static load (T_s) Required torque $T = T_s$ Resistance load (T_f) Required torque $T = T_f \times (3 \text{ to } 5)$ Inertial load (T_a) Required torque $T = T_a \times 10$ \Rightarrow p. 10 	<p>When the resistance load is rotated, the required torque calculated from the inertial load must be added.</p> <p>Required torque $T = T_f \times (3 \text{ to } 5) + T_a \times 10$</p>	<p>Inertial load: T_a $T_a = I \cdot \dot{\omega}$ $\dot{\omega} = \frac{2\theta}{t^2} \text{ [rad/s}^2]$</p> <p>Required torque: T $T = T_a \times 10$ $= 0.003896 \times \frac{2 \times \pi}{1.5^2} \times 10 = 0.109 \text{ [N}\cdot\text{m]}$ $0.109 \text{ N}\cdot\text{m} < \text{Effective torque OK}$</p>
3 Confirmation of Rotation Time		
<p>Confirm whether the time falls in the rotation time adjustment range. \Rightarrow p. 10</p>	<p>Consider the time after converted in the time per 90°. $(1.0 \text{ s}/180^\circ \text{ is converted in } 0.5 \text{ s}/90^\circ.)$</p>	<p>$0.2 \leq t \leq 2.0$ $t = 0.75 \text{ s}/90^\circ \text{ OK}$</p>
4 Calculation of Kinetic Energy		
<p>Calculate the kinetic energy of the load and confirm whether the energy is below the allowable range.</p> <p>Can confirm referring to the inertial moment and rotation time graph (p. 12) \Rightarrow p. 11</p>		<p>Kinetic energy: E $E = \frac{1}{2} \cdot I \cdot \omega^2$ $\omega = \frac{2 \cdot \theta}{t}$ $E = \frac{1}{2} \times 0.003896 \times \left(\frac{2 \times \pi}{1.5}\right)^2 = 0.03418 \text{ [J]}$ $0.03418 \text{ [J]} < \text{Allowable energy OK}$</p>
5 Confirmation of Allowable Load		
<p>Confirm whether the load applied to the product is within the allowable range. \Rightarrow p. 13</p>		<p>Moment load: M $M = 0.4 \times 9.8 \times 0.05 + 0.2 \times 9.8 \times 0.1$ $= 0.392 \text{ [N}\cdot\text{m]}$ $0.392 \text{ [N}\cdot\text{m]} < \text{Allowable moment load OK}$</p>
6 Calculation of Air Consumption and Required Air Flow Capacity		
<p>Air consumption and required air flow capacity are calculated when necessary. \Rightarrow p. 13</p>		

1 Calculation of Moment of Inertia

The moment of inertia is a value indicating the inertia of a rotating body, and expresses the degree to which the body is difficult to rotate, or difficult to stop.

It is necessary to know the moment of inertia of the load in order to determine the value of required torque or kinetic energy when selecting a rotary actuator.

Moving the load with the actuator creates kinetic energy in the load. When stopping the moving load, it is necessary to absorb the kinetic energy of the load with a stopper or a shock absorber.

The kinetic energy of the load can be calculated using the formulas shown in **Fig. 1** (for linear motion) and **Fig. 2** (for rotation motion).

In the case of the kinetic energy for linear motion, the formula (1) shows that when the velocity **V** is constant, it is proportional to the mass **m**. In the case of rotation motion, the formula (2) shows that when the angular velocity ω is constant, it is proportional to the moment of inertia.

Linear motion

Fig. 1 Linear motion

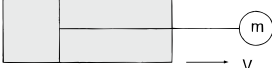

$$E = \frac{1}{2} \cdot m \cdot V^2 \dots\dots\dots (1)$$

E: Kinetic energy
m: Load mass
V: Velocity

Rotation motion

Fig. 2 Rotation motion

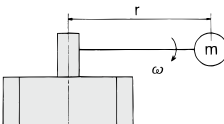

$$E = \frac{1}{2} \cdot I \cdot \omega^2 = \frac{1}{2} \cdot m \cdot r^2 \cdot \omega^2 \dots\dots\dots (2)$$

E: Kinetic energy
I: Moment of inertia (= $m \cdot r^2$)
 ω : Angular velocity
m: Mass
r: Radius of rotation

As the moment of inertia is proportional to the squares of the mass and the radius of rotation, even when the load mass is the same, the moment of inertia will be squared as the radius of rotation grows bigger. This will create greater kinetic energy, which may result in damage to the product.

When there is rotation motion, product selection should be based not on the load mass of the load, but on the moment of inertia.

Moment of Inertia Formula

The basic formula for finding a moment of inertia is shown below.

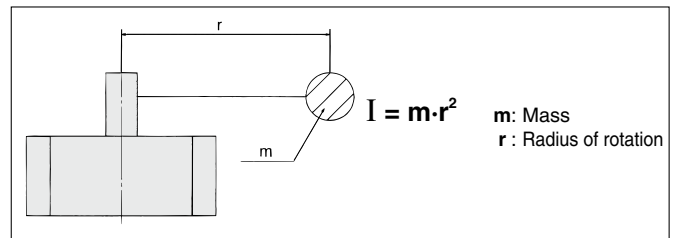

This formula represents the moment of inertia for the shaft with mass **m**, which is located at distance **r** from the shaft.

For actual loads, the values of the moment of inertia are calculated depending on configurations, as shown below.

- ⇒ p. 7, 8 Calculation example of moment of inertia
- ⇒ p. 9 Graph for calculating the moment of inertia

Equation Table of Moment of Inertia

I: Moment of inertia m: Load mass

1. Thin shaft

Position of rotational axis: Perpendicular to the shaft through the center of gravity

$$I = m \cdot \frac{a^2}{12}$$

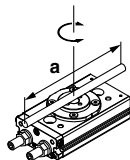

2. Thin rectangular plate

Position of rotational axis: Parallel to side **b** and through the center of gravity

$$I = m \cdot \frac{a^2}{12}$$

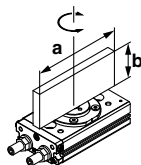

3. Thin rectangular plate (Including rectangular parallelepiped)

Position of rotational axis: Perpendicular to the plate through the center of gravity

$$I = m \cdot \frac{a^2 + b^2}{12}$$

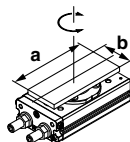

4. Round plate (Including column)

Position of rotational axis: Through the center axis

$$I = m \cdot \frac{r^2}{2}$$

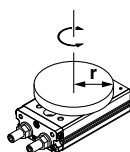

5. Solid sphere

Position of rotational axis: Through the center of diameter

$$I = m \cdot \frac{2r^2}{5}$$

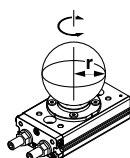

6. Thin round plate

Position of rotational axis: Through the center of diameter

$$I = m \cdot \frac{r^2}{4}$$

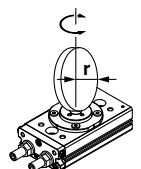

7. Cylinder

Position of rotational axis: Through the center of diameter and gravity

$$I = m \cdot \frac{3r^2 + a^2}{12}$$

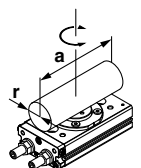

8. When the rotational axis and load center of gravity are not consistent

$$I = K + m \cdot L^2$$

K: Moment of inertia around the load center of gravity

4. Round plate $K = m \cdot \frac{r^2}{2}$

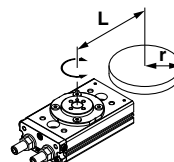

9. Gear transmission

1. Find the moment of inertia **I_B** for the rotation of shaft (B).

2. **I_B** is converted to the moment of inertia **I_A** for the rotation of the shaft (A).

$$I_A = \left(\frac{a}{b}\right)^2 \cdot I_B$$

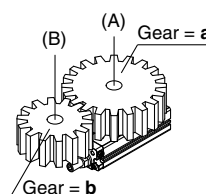

Rotary Actuator Model Selection

● Calculation Example of Moment of Inertia

■ If the shaft is located at a desired point of the load:

Example: ① If the load is the thin rectangular plate:

Find the center of gravity of the load as I_1 , a provisional shaft.

$$I_1 = m \cdot \frac{a^2 + b^2}{12}$$

② Find the actual moment of inertia I_2 around the shaft, with the premise that the mass of the load itself is concentrated in the load's center of gravity point.

$$I_2 = m \cdot L^2$$

③ Find the actual moment of inertia I .

$$I = I_1 + I_2$$

(m : Load mass
 L : Distance from the shaft to the load's center of gravity)

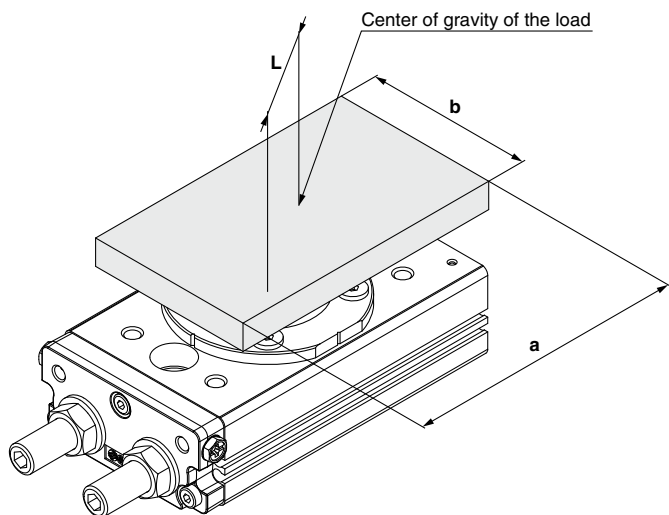

Calculation Example

$$a = 0.2 \text{ m}, b = 0.1 \text{ m}, L = 0.05 \text{ m}, m = 1.5 \text{ kg}$$

$$I_1 = 1.5 \times \frac{0.2^2 + 0.1^2}{12} = 6.25 \times 10^{-3} \text{ kg}\cdot\text{m}^2$$

$$I_2 = 1.5 \times 0.05^2 = 3.75 \times 10^{-3} \text{ kg}\cdot\text{m}^2$$

$$I = (6.25 + 3.75) \times 10^{-3} = 0.01 \text{ kg}\cdot\text{m}^2$$

■ If the load is divided into multiple loads:

Example: ① If the load is divided into the 2 cylinders:

{ The center of gravity of load 1 matches the shaft
 { The center of gravity of load 2 differs from the shaft }

Find the moment of inertia of load 1:

$$I_1 = m_1 \cdot \frac{r_1^2}{2}$$

② Find the moment of inertia of load 2:

$$I_2 = m_2 \cdot \frac{r_2^2}{2} + m_2 \cdot L^2$$

③ Find the actual moment of inertia I :

$$I = I_1 + I_2$$

(m_1, m_2 : Mass of loads 1 and 2
 r_1, r_2 : Radius of loads 1 and 2
 L : Distance from the shaft to the center of gravity of load 2)

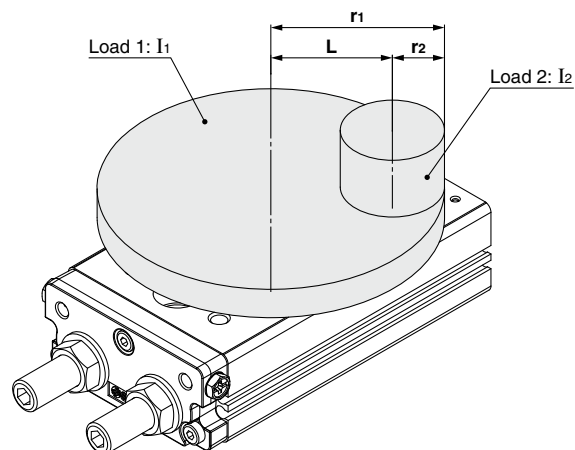

Calculation Example

$$m_1 = 2.5 \text{ kg}, m_2 = 0.5 \text{ kg}, r_1 = 0.1 \text{ m}, r_2 = 0.02 \text{ m}, L = 0.08 \text{ m}$$

$$I_1 = 2.5 \times \frac{0.1^2}{2} = 1.25 \times 10^{-2} \text{ kg}\cdot\text{m}^2$$

$$I_2 = 0.5 \times \frac{0.02^2}{2} + 0.5 \times 0.08^2 = 0.33 \times 10^{-2} \text{ kg}\cdot\text{m}^2$$

$$I = (1.25 + 0.33) \times 10^{-2} = 1.58 \times 10^{-2} \text{ kg}\cdot\text{m}^2$$

Rotary Actuator Model Selection

■ If a lever is attached to the shaft and a cylinder and a gripper are mounted to the tip of the lever:

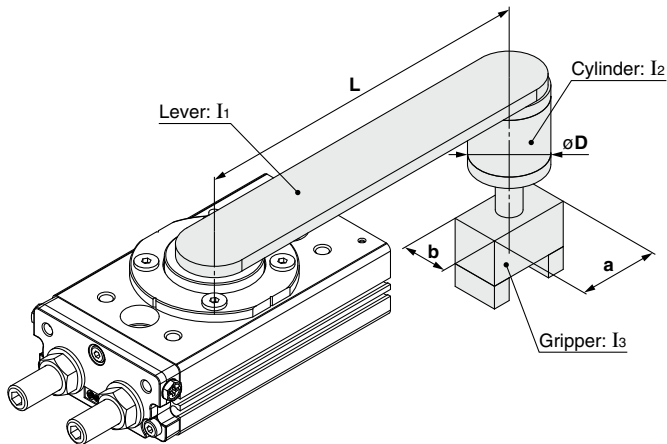

Example: ① Find the lever's moment of inertia:

$$I_1 = m_1 \cdot \frac{L^2}{3}$$

② Find the cylinder's moment of inertia:

$$I_2 = m_2 \cdot \frac{(D/2)^2}{2} + m_2 \cdot L^2$$

③ Find the gripper's moment of inertia:

$$I_3 = m_3 \cdot \frac{a^2 + b^2}{12} + m_3 \cdot L^2$$

④ Find the actual moment of inertia:

$$I = I_1 + I_2 + I_3$$

(m_1 : Mass of lever
 m_2 : Mass of cylinder
 m_3 : Mass of gripper)

Calculation Example

$L = 0.2 \text{ m}$, $\text{ø}D = 0.06 \text{ m}$, $a = 0.06 \text{ m}$, $b = 0.03 \text{ m}$, $m_1 = 0.5 \text{ kg}$, $m_2 = 0.4 \text{ kg}$, $m_3 = 0.2 \text{ kg}$

$$I_1 = 0.5 \times \frac{0.2^2}{3} = 0.67 \times 10^{-2} \quad \text{kg} \cdot \text{m}^2$$

$$I_2 = 0.4 \times \frac{(0.06/2)^2}{2} + 0.4 \times 0.2^2 = 1.62 \times 10^{-2} \quad \text{kg} \cdot \text{m}^2$$

$$I_3 = 0.2 \times \frac{0.06^2 + 0.03^2}{12} + 0.2 \times 0.2^2 = 0.81 \times 10^{-2} \quad \text{kg} \cdot \text{m}^2$$

$$I = (0.67 + 1.62 + 0.81) \times 10^{-2} = 3.1 \times 10^{-2} \quad \text{kg} \cdot \text{m}^2$$

■ If a load is rotated through the gears:

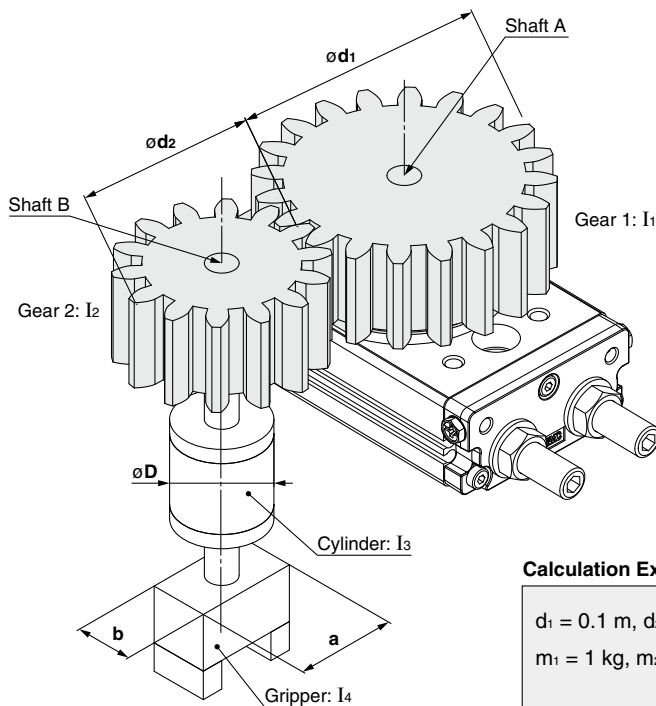

Example: ① Find the moment of inertia I_1 around shaft A:

$$I_1 = m_1 \cdot \frac{(d_1/2)^2}{2}$$

② Find moment of inertias I_2 , I_3 , and I_4 around shaft B:

$$I_2 = m_2 \cdot \frac{(d_2/2)^2}{2} \quad I_3 = m_3 \cdot \frac{(D/2)^2}{2}$$

$$I_4 = m_4 \cdot \frac{a^2 + b^2}{12} \quad I_B = I_2 + I_3 + I_4$$

③ Replace the moment of inertia I_B around shaft B with the moment of inertia I_A around shaft A.

$$I_A = (A/B)^2 \cdot I_B \quad [A/B: \text{Ratio of the number of teeth}]$$

④ Find the actual moment of inertia:

$$I = I_1 + I_A$$

(m_1 : Mass of gear 1
 m_2 : Mass of gear 2
 m_3 : Mass of cylinder
 m_4 : Mass of gripper)

Calculation Example

$d_1 = 0.1 \text{ m}$, $d_2 = 0.05 \text{ m}$, $D = 0.04 \text{ m}$, $a = 0.04 \text{ m}$, $b = 0.02 \text{ m}$

$m_1 = 1 \text{ kg}$, $m_2 = 0.4 \text{ kg}$, $m_3 = 0.5 \text{ kg}$, $m_4 = 0.2 \text{ kg}$, Ratio of the number of teeth = 2

$$I_1 = 1 \times \frac{(0.1/2)^2}{2} = 1.25 \times 10^{-3} \text{ kg} \cdot \text{m}^2$$

$$I_2 = 0.4 \times \frac{(0.05/2)^2}{2} = 0.13 \times 10^{-3} \text{ kg} \cdot \text{m}^2$$

$$I_3 = 0.5 \times \frac{(0.04/2)^2}{2} = 0.1 \times 10^{-3} \text{ kg} \cdot \text{m}^2$$

$$I_4 = 0.2 \times \frac{0.04^2 + 0.02^2}{12} = 0.03 \times 10^{-3} \text{ kg} \cdot \text{m}^2$$

$$I_B = (0.13 + 0.1 + 0.03) \times 10^{-3} = 0.26 \times 10^{-3} \text{ kg} \cdot \text{m}^2$$

$$I_A = 2^2 \times 0.26 \times 10^{-3} = 1.04 \times 10^{-3} \text{ kg} \cdot \text{m}^2$$

$$I = (1.25 + 1.04) \times 10^{-3} = 2.29 \times 10^{-3} \text{ kg} \cdot \text{m}^2$$

Rotary Actuator Model Selection

● Graph for Calculating the Moment of Inertia

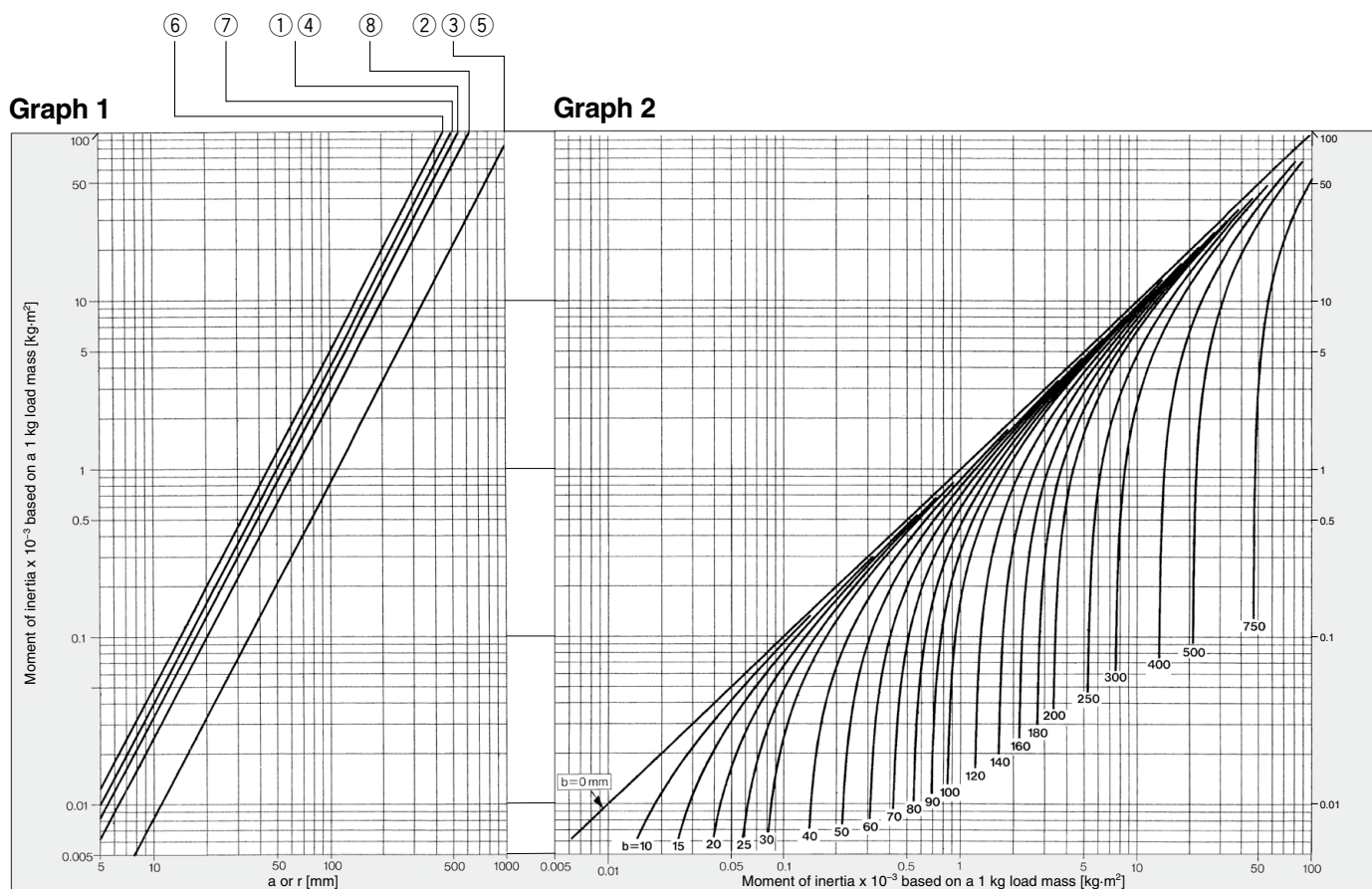
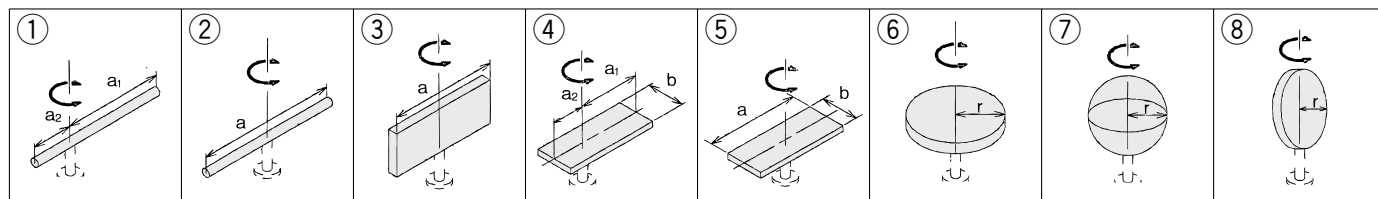

How to read the graph: Only when the dimension of the load is "a" or "r"

[Example] When the load shape is ②, $a = 100$ mm, and the load mass is 0.1 kg

In graph 1, the point at which the vertical line of $a = 100$ mm and the line of the load shape ② intersect indicates that the moment of inertia of the 1 kg mass is $0.83 \times 10^{-3} \text{ kg}\cdot\text{m}^2$.

Since the load mass is 0.1 kg, the actual moment of inertia is $0.83 \times 10^{-3} \times 0.1 = 0.083 \times 10^{-3} \text{ kg}\cdot\text{m}^2$

(Note: If "a" is divided into "a1a2", the moment of inertia can be found by calculating them separately.)

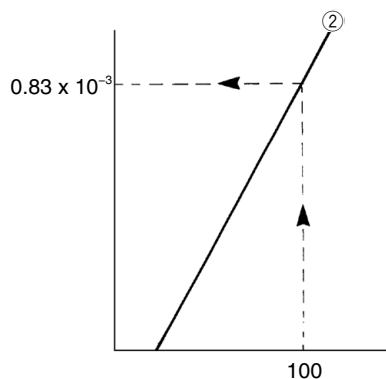

How to read the graph: When the dimension of the load contains both "a" and "b"

[Example] When the load shape is ⑤, $a = 100$ mm, $b = 100$ mm, and the load mass is 0.5 kg

In graph 1, find the point at which the vertical line of $a = 100$ mm and the line of the load shape ⑤ intersect. Move this intersection point to graph 2, and the point at which it intersects with the curve of $b = 100$ mm indicates that the moment of inertia of the 1 kg mass is $1.7 \times 10^{-3} \text{ kg}\cdot\text{m}^2$.

Since the load mass is 0.5 kg, the actual moment of inertia is $1.7 \times 10^{-3} \times 0.5 = 0.85 \times 10^{-3} \text{ kg}\cdot\text{m}^2$

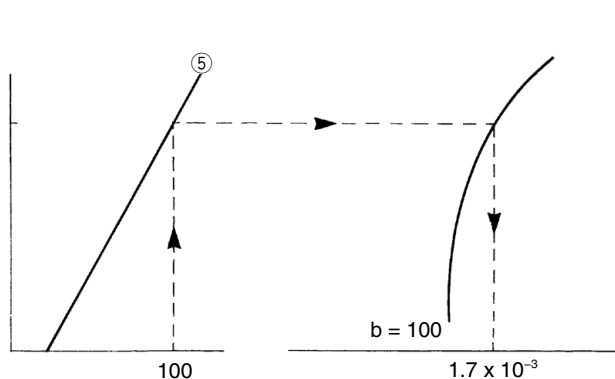

2 Calculation of Required Torque

● Load Type

The calculation method of required torque varies depending on the load type. Find the required torque referring to the table below.

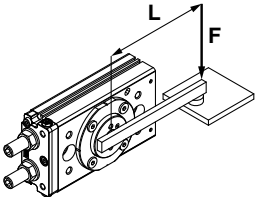
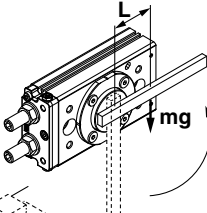
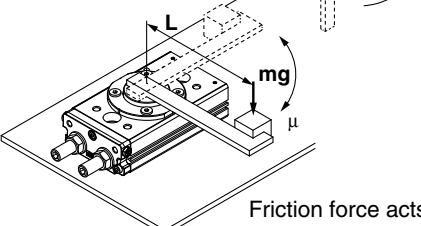
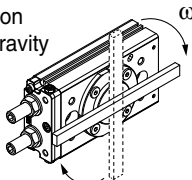
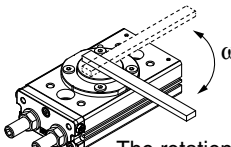
Load type		
Static load: T_s	Resistance load: T_f	Inertial load: T_a
When the pressing force is necessary (clamp, etc.)	When friction force or gravity is applied to the rotation direction	When the load with inertia is rotated
	<p>Gravity acts</p>  <p>Friction force acts</p> 	<p>The center of rotation and the center of gravity are corresponding</p>  <p>The rotational axis is vertical (up and down)</p> 
$T_s = F \cdot L$ T_s : Static load [N·m] F : Clamp force [N] L : Distance from the center of rotation to clamp [m]	<p>When gravity acts to the rotation direction</p> $T_f = m \cdot g \cdot L$ <p>When friction force acts to the rotation direction</p> $T_f = \mu \cdot m \cdot g \cdot L$ T_f : Resistance load [N·m] m : Load mass [kg] g : Gravitational acceleration 9.8 [m/s ²] L : Distance from the center of rotation to the gravity or friction force acting point [m] μ : Coefficient of friction	$T_a = I \cdot \dot{\omega} = I \cdot \frac{2\theta}{t^2}$ T_a : Inertial load [N·m] I : Moment of inertia [kg·m ²] $\dot{\omega}$: Angular acceleration [rad/s ²] θ : Rotating angle [rad] t : Rotation time [s]
Required torque $T = T_s$	Required torque $T = T_f \times (3 \text{ to } 5)^{*1}$	Required torque $T = T_a \times 10^{*1}$
<p>· Resistance loads → Gravity or friction applies in the rotation direction. Example 1) The axis of rotation is in a horizontal (lateral) direction, and the center of rotation and center of gravity of the load are not the same. Example 2) The load slips against the floor while rotating. * The required torque equals the total of the resistance load and inertial load. $T = T_f \times (3 \text{ to } 5) + T_a \times 10$</p> <p>· Non-resistance loads → Gravity or friction does not apply in the rotation direction. Example 1) The axis of rotation is in a perpendicular (vertical) direction. Example 2) The axis of rotation is in a horizontal (lateral) direction, and the center of rotation and center of gravity of the load are the same. * The required torque equals the inertial load only. $T = T_a \times 10$</p>		

● Effective Torque

[N·m]

Size	Operating pressure [MPa]									
	0.1	0.2	0.3	0.4	0.5	0.6	0.7	0.8	0.9	1.0
10	0.18	0.36	0.53	0.71	0.89	1.07	1.25	1.42	1.60	1.78
20	0.37	0.73	1.10	1.47	1.84	2.20	2.57	2.93	3.29	3.66
30	0.55	1.09	1.64	2.18	2.73	3.19	3.82	4.37	4.91	5.45
50	0.93	1.85	2.78	3.71	4.64	5.57	6.50	7.43	8.35	9.28

3 Confirmation of Rotation Time

For stable operation, check that each product is used within the allowable rotation time range.

MSQ□□_A (Cushion pad, Bumper): 0.2 to 2.0 s/90° MSQ□□R (Internal shock absorber): 0.2 to 0.7 s/90°

Rotary Actuator Model Selection

4 Calculation of Kinetic Energy

Kinetic energy is generated when the load rotates. Kinetic energy applies on the product at the operating end as inertial force, and may cause the product to damage. In order to avoid this, the value of allowable kinetic energy is determined for each product. Find the kinetic energy of the load, and verify that it is within the allowable range for the product in use.

Kinetic Energy

Use the following formula to calculate the kinetic energy of the load.

$$E = \frac{1}{2} \cdot I \cdot \omega^2$$

E : Kinetic energy [J]
I : Moment of inertia [kg·m²]
ω : Angular velocity [rad/s]

⇒ p. 12 Moment of inertia and rotation time

Angular Velocity

$$\omega = \frac{2\theta}{t}$$

ω : Angular velocity [rad/s]
θ : Rotating angle [rad]
t : Rotation time [s]

To find the rotation time when kinetic energy is within the allowable range for the product, use the following formula.

When the angular velocity is $\omega = \frac{2\theta}{t}$

$$t \geq \sqrt{\frac{2 \cdot I \cdot \theta^2}{E}}$$

t : Rotation time [s]
I : Moment of inertia [kg·m²]
θ : Rotating angle [rad]
E : Allowable kinetic energy [J]

● Allowable Kinetic Energy and Rotation Time Adjustment Range

Allowable Kinetic Energy and Rotation Time Adjustment Range

Size	Allowable kinetic energy [J]			Adjustable range of rotation time safe in operation [s/90°]		
	Cushion pad	Bumper	Internal shock absorber	Cushion pad	Bumper	Internal shock absorber
10	0.007	0.014	0.039	0.2 to 2.0		0.2 to 0.7
20	0.025	0.042	0.116			
30	0.048	0.072	0.116			
50	0.081	0.162	0.294			

Calculation Example

Load form: Round rod
 Length of **a₁** part : 0.12 m Rotating angle: 90°
 Length of **a₂** part : 0.04 m Rotation time : 0.9 s/90°
 Mass of **a₁** part (= **m₁**): 0.09 kg
 Mass of **a₂** part (= **m₂**): 0.03 kg

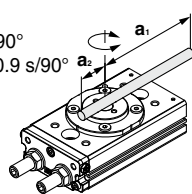

$$I = m_1 \cdot \frac{a_1^2}{3} + m_2 \cdot \frac{a_2^2}{3}$$

(Step 1) Find the angular velocity ω .

$$\omega = \frac{2\theta}{t} = \frac{2}{0.9} \left(\frac{\pi}{2} \right) = 3.489 \text{ rad/s}$$

(Step 2) Find the moment of inertia **I**.

$$I = \frac{m_1 \cdot a_1^2}{3} + \frac{m_2 \cdot a_2^2}{3} = \frac{0.09 \times 0.12^2}{3} + \frac{0.03 \times 0.04^2}{3} = 4.48 \times 10^{-4} \text{ kg} \cdot \text{m}^2$$

(Step 3) Find the kinetic energy **E**.

$$E = \frac{1}{2} \cdot I \cdot \omega^2 = \frac{1}{2} \times 4.48 \times 10^{-4} \times 3.489^2 = 0.00273 \text{ J}$$

Calculation Example

If the model to be used has been determined, find the threshold rotation time in which the rotary actuator can be used in accordance with the allowable kinetic energy of that model.

Model used : MSQ50A (Cushion pad)
 Allowable kinetic energy: 0.081 J (Refer to the table above.)
 Load form : Refer to the figure below.
 Rotating angle : 90°

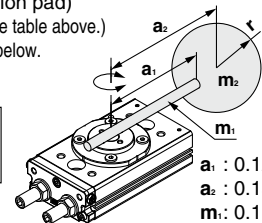

$$I = m_1 \cdot \frac{a_1^2}{3} + m_2 \cdot a_2^2 + m_2 \cdot \frac{2r^2}{5}$$

(Step 1) Find the moment of inertia.

$$I = \frac{m_1 \cdot a_1^2}{3} + m_2 \cdot a_2^2 + \frac{m_2 \cdot 2r^2}{5} = \frac{0.1 \times 0.12^2}{3} + 0.18 \times 0.15^2 + \frac{0.18 \times 2 \times 0.03^2}{5} = 4.6 \times 10^{-3} \text{ kg} \cdot \text{m}^2$$

(Step 2) Find the rotation time.

$$t \geq \sqrt{\frac{2 \cdot I \cdot \theta^2}{E}} = \sqrt{\frac{2 \times 4.6 \times 10^{-3} \times (\pi/2)^2}{0.081}} = 0.53 \text{ s}$$

It is therefore evident that there will be no problem if it is used with a rotation time of less than 0.53 s. However, according to the table above, the max. value of rotation time for stable operation is 2 s. Thus, the rotation time should be within the range of $0.53 \leq t \leq 2$.

Rotary Actuator Model Selection

● Moment of Inertia and Rotation Time

How to read the graph

Example 1) When there are constraints on the moment of inertia of the load and the rotation time:

When the load's moment of inertia is $1 \times 10^{-3} \text{ kg}\cdot\text{m}^2$ and the rotation time is set at $0.03 \text{ s}/90^\circ$, we can see from graphs 3 to 5 that the size of the product suitable to each cushion type is as follows.

Cushion pad : MSQ50A

Bumper : MSQ30, 50D

Internal shock absorber: MSQ20 to 50R

Example 2) When there are constraints on the moment of inertia of the load but not the rotation time:

We can see from graphs 3 to 5 that to operate the load at a $1 \times 10^{-2} \text{ kg}\cdot\text{m}^2$ moment of inertia:

MSQ50A will be 0.8 to $2 \text{ s}/90^\circ$.

MSQ50D will be 0.55 to $2 \text{ s}/90^\circ$.

MSQ50R will be 0.4 to $0.7 \text{ s}/90^\circ$.

[Remarks] As for the rotation times in graphs 3 to 5, the lines in the graph indicate the adjustable speed ranges. However, if the speed is adjusted toward the low-speed end beyond the range of the line, the actuator may stick.

Graph 3 Cushion Pad

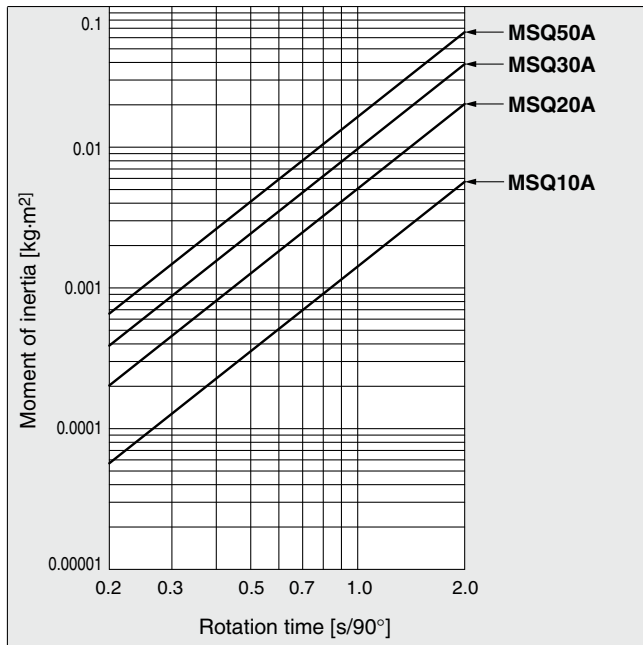

Graph 4 Bumper

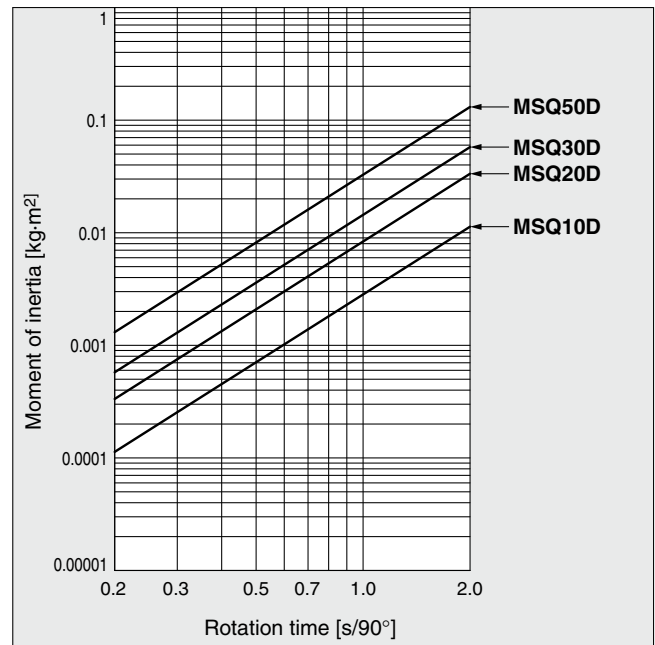

Graph 5 Internal Shock Absorber

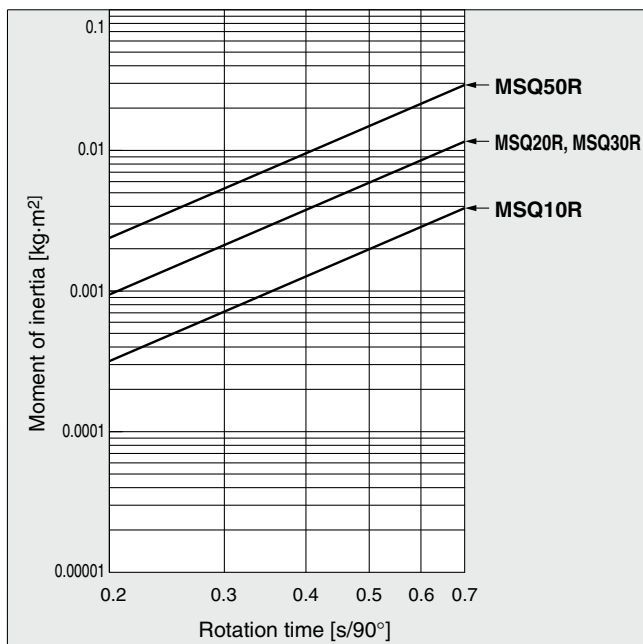

Rotary Actuator Model Selection

5 Confirmation of Allowable Load

Provided that a dynamic load is not generated, a load in the axial direction can be applied up to the value that is indicated in the table to the right. However, applications in which the load is applied directly to the shaft should be avoided as much as possible.

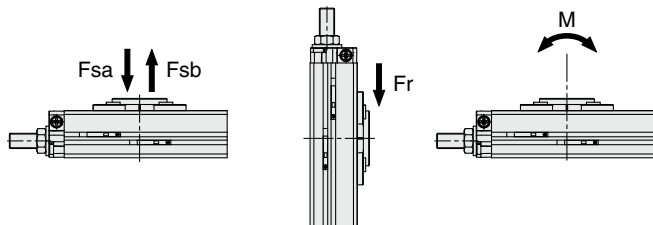

Size	Load direction			
	Fsa [N]	Fsb [N]	Fr [N]	M [N·m]
10	78	74	78	2.4
20	137	137	147	4.0
30	363	197	196	5.3
50	451	296	314	9.7

6 Calculation of Air Consumption and Required Air Flow Capacity

Air consumption is the volume of air which is expended by the rotary actuator's reciprocal operation inside the actuator and in the piping between the actuator and the switching valve, etc. This is necessary for selection of a compressor and for calculation of its running cost. Required air volume is the air volume necessary to make a rotary actuator operate at a required speed. It requires calculation when selecting the upstream piping diameter from the switching valve and air line equipment.

* For the air consumption calculation graph, refer to graphs 6 and 7 on page 14.

① Air consumption volume

Formula

$$Q_{CR} = V \times \left(\frac{P+0.1}{0.1} \right) \times 10^{-3} \dots\dots\dots (1)$$

$$Q_{CP} = 2 \times a \times L \times \left(\frac{P}{0.1} \right) \times 10^{-6} \dots\dots\dots (2)$$

$$Q_C = Q_{CR} + Q_{CP} \dots\dots\dots (3)$$

- Q_{CR} = Amount of air consumption of rotary actuator [L (ANR)]
- Q_{CP} = Amount of air consumption of tube or piping [L (ANR)]
- V = Inner volume of the rotary actuator (1 cycle) [cm³]
- P = Operating pressure [MPa]
- L = Length of piping [mm]
- a = Inner sectional area of piping [mm²]
- Q_C = Amount of air consumption required for one cycle of the rotary actuator [L (ANR)]

To select a compressor, it is important to select one that has plenty of margin to accommodate the total air volume that is consumed by the pneumatic actuators that are located downstream. The total air consumption volume is affected by the leakage in the tube, the consumption in the drain valves and pilot valves, as well as by the reduction in air volume due to reduced temperature.

Formula

$$Q_{c2} = Q_C \times n \times \text{No. of actuators} \times \text{Safety factor} \dots\dots (4)$$

- Q_{c2} = Amount of air from a compressor [L/min (ANR)]
- n = Actuator reciprocations per minute
- Safety factor: From 1.5

② Required air flow capacity

Formula

$$Q_r = \left\{ \frac{V}{2} \times \left(\frac{P+0.1}{0.1} \right) \times 10^{-3} + a \times L \times \left(\frac{P}{0.1} \right) \times 10^{-6} \right\} \times \frac{60}{t} \dots\dots (5)$$

- Q_r = Consumed air volume for rotary actuator [L/min (ANR)]
- V = Inner volume of the rotary actuator (1 cycle) [cm³]
- P = Operating pressure [MPa]
- L = Length of piping [mm]
- a = Inner sectional area of piping [mm²]
- t = Total time for rotation [S]

Internal Cross Section of Tubing and Steel Tube

Nominal	O.D. [mm]	I.D. [mm]	Internal cross section a [mm ²]
T□ 0425	4	2.5	4.9
T□ 0604	6	4	12.6
TU 0805	8	5	19.6
T□ 0806	8	6	28.3

Rotary Actuator Model Selection

● Air Consumption Calculation Graph

Step 1 Using graph 6, air consumption volume of the rotary actuator is found. From the point of intersection between the inner volume and the operating pressure (slanted line) and then looking to the side (left side) direction, the air consumption volume for 1 cycle operation of a rotary actuator is found.

Step 2 Using graph 7, the air consumption volume for 1 cycle operation of tubing or steel tube is found.
 (1) First determine the point of intersection between the operating pressure (slanted line) and the piping length, and then go up the vertical line perpendicularly from there.
 (2) From the point of intersection of an operating piping tube inside diameter (slanted line), then look to the side (left or right) to find the required air consumption volume for piping.

Step 3 Total air consumption volume per minute is found as follows:
 (Air consumption volume of a rotary actuator [unit: L (ANR)] + Tubing or steel tube's air consumption volume) x Cycle times per minute x Number of rotary actuators = Total air consumption volume

Example) When 10 units of an MSQ30A are used at a pressure of 0.5 MPa, what is the air consumption of their 5 cycles per minute? (Piping between the actuator and switching valve is a tube with an inside diameter of 6 mm and length of 2 m.)

1. Operating pressure 0.5 MPa → Inner volume of MSQ30A 47.4 cm³ → Air consumption volume 0.25 L (ANR)
2. Operating pressure 0.5 MPa → Piping length 2 m → Inside diameter 6 mm → Air consumption volume 0.56 L (ANR)
3. Total air consumption volume = (0.25 + 0.56) x 5 x 10 = 40.5 L/min (ANR)

Graph 6 Air Consumption (1 cycle)

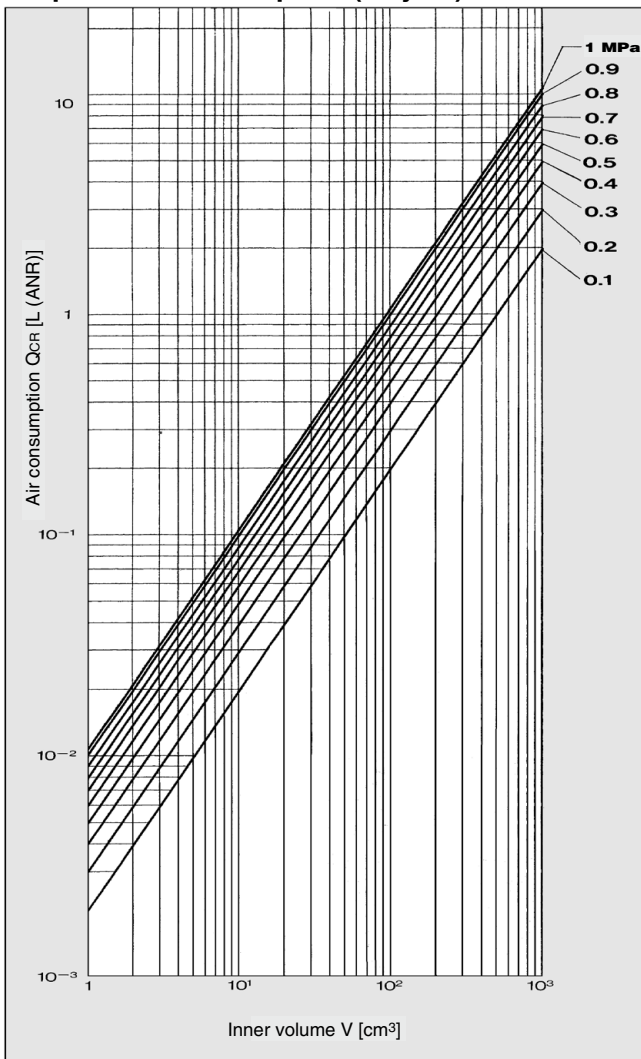

Inner Volume		1 cycle [cm ³]
Size	Rotating angle	
	190°	
10	15.6	
20	30.8	
30	47.4	
50	76.0	

Graph 7 Air Consumption of Tubing, Steel Tube (1 cycle)

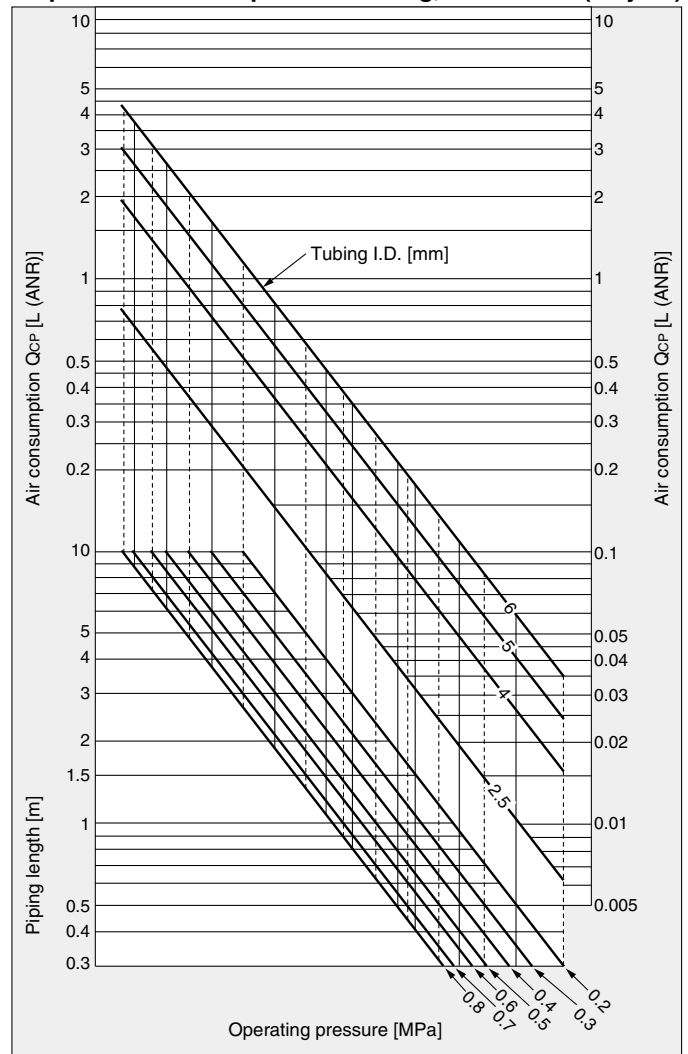

- * "Piping length" indicates the length of steel tube or tubing which connects rotary actuator and switching valves (solenoid valves, etc.).
- * Refer to page 13 for the size of tubing and steel tube (inside diameter and outside diameter).

Rotary Table/Rack & Pinion Type

MSQ Series

Size: 10, 20, 30, 50



How to Order

Basic type **MSQ 10 A - M9BW** [] [] - []

Size

10
20
30
50

• Made to order
For details, refer to the next page.

• Port type

End port type		Size
Nil	M5	10, 20
Nil	Rc1/8	30, 50
-XF	G1/8	
-XN	NPT1/8	

* Side ports are all M5.
For details, refer to the specifications on page 16.

• Number of auto switches

Nil	2
S	1
n	n

• Auto switch

Nil	Without auto switch (Built-in magnet)
-----	---------------------------------------

* For applicable auto switches, refer to the table below.

A	Cushion pad	
D	Bumper	
R	Internal shock absorber	

Applicable Auto Switches/Refer to the Web Catalog for further information on auto switches.

Type	Special function	Electrical entry	Indicator light	Wiring (Output)	Load voltage		Auto switch model		Lead wire length [m]				Pre-wired connector	Applicable load			
					DC	AC	Perpendicular	In-line	0.5 (Nil)	1 (M)	3 (L)	5 (Z)					
Solid state auto switch	Diagnostic indication (2-color indicator)	Grommet	Yes	3-wire (NPN)	24 V	5 V, 12 V	—	M9NV	M9N	●	●	●	○	○	IC circuit	Relay, PLC	
				3-wire (PNP)				M9PV	M9P	●	●	●	○	○			
				2-wire				M9BV	M9B	●	●	●	○	○			
				3-wire (NPN)				M9NWV	M9NW	●	●	●	○	○			
				3-wire (PNP)				M9PWV	M9PW	●	●	●	○	○			
				2-wire				M9BWV	M9BW	●	●	●	○	○			
	Water resistant (2-color indicator)	Grommet	No	3-wire (NPN)	24 V	5 V, 12 V	—	—	M9NAV*1	M9NA*1	○	○	●	○	○	IC circuit	—
				3-wire (PNP)					M9PAV*1	M9PA*1	○	○	●	○	○		
				2-wire					M9BAV*1	M9BA*1	○	○	●	○	○		
Reed auto switch	—	Grommet	Yes	3-wire (NPN equiv.)	24 V	12 V	100 V 100 V or less	A96V	A96	●	—	●	—	—	IC circuit	—	
				2-wire				A93V*2	A93	●	●	●	●	—	—	—	IC circuit
			No	2-wire	24 V	12 V	100 V 100 V or less	A90V	A90	●	—	●	—	—	IC circuit	Relay, PLC	

*1 Although it is possible to mount water-resistant type auto switches, note that the rotary actuator itself is not of water-resistant construction.

*2 The 1 m lead wire is only applicable to the D-A93.

* Lead wire length symbols: 0.5 m..... Nil (Example) M9NW
 1 m..... M (Example) M9NWM
 3 m..... L (Example) M9NWL
 5 m..... Z (Example) M9NWX

* Solid state auto switches marked with "○" are produced upon receipt of order.

* Auto switches are shipped together with the product but do not come assembled.

Specifications



Symbol

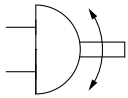

Made to Order
(For details, refer to page 23.)

Symbol	Specifications
A	With interchangeable table and plate
B	With interchangeable table
C	With interchangeable plate

Refer to page 21 for models with auto switches.

· Auto Switch Proper Mounting Position
(at Rotation End Detection)

Size		10	20	30	50
Fluid		Air (Non-lube)			
Max. operating pressure	Cushion pad	1 MPa			
	Bumper				
	Internal shock absorber				
Min. operating pressure		0.1 MPa* ²			
Ambient and fluid temperatures		0 to 60°C (No freezing)			
Cushion	Cushion pad* ³	Rubber bumper			
	Bumper				
	Internal shock absorber				
Angle adjustment range*⁴		0 to 190°* ⁵			
Max. rotating angle*⁴		190°			
Cylinder bore size		ø13	ø16	ø20	ø22
Port size	End port	M5 x 0.8		Rc1/8, G1/8, NPT1/8	
	Side port	M5 x 0.8			

*1 The max. operating pressure of the actuator is restricted by the max. allowable thrust of the shock absorber.

*2 Refer to page 24 for the min. operating pressure with a bumper.

*3 Reduces noise when the piston and adjustment bolt collide.

*4 For details, refer to page 17.

*5 If the rotating angle of the type with an internal shock absorber is set below the value in the table below, the piston stroke will be smaller than the shock absorber's effective stroke, resulting in decreased energy absorption ability.

Size	10	20	30	50
Min. rotating angle that will not result in decrease of the energy absorption ability	40°	35°	35°	47°

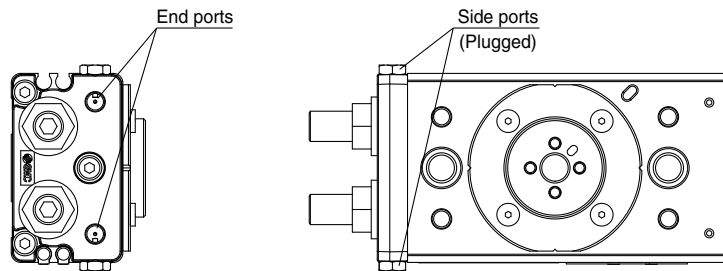

Allowable Kinetic Energy and Rotation Time Adjustment Range

Size	Allowable kinetic energy [J]* ¹			Adjustable range of rotation time safe in operation [s/90°]		
	Cushion pad	Bumper	Internal shock absorber	Cushion pad	Bumper	Internal shock absorber* ²
10	0.007	0.014	0.039	0.2 to 2.0		0.2 to 0.7
20	0.025	0.042	0.116			
30	0.048	0.072	0.116			
50	0.081	0.162	0.294			

*1 If operated so that the kinetic energy exceeds the allowable value, damage to the internal parts or product failure may result. Please pay special attention to the kinetic energy levels when designing and during operation to avoid exceeding the allowable limit.

*2 If the rotation time of the type with an internal shock absorber is set longer than the time shown in the table above, the energy absorption ability of the shock absorber will greatly decrease.

Weight

Size		10	20	30	50
Basic type	Cushion pad	375	680	930	1500
	Bumper				
	Internal shock absorber				

* The values above do not include the auto switch weight.

* For made-to-order options, add the weight in the table below to the weight of the base model.

Size	10	20	30	50
With interchangeable table and plate	70	160	120	220
With interchangeable table	30	60	80	130
With interchangeable plate	40	100	40	90

Rotation Direction and Rotating Angle

- The rotary table turns in the counterclockwise direction where the A port is pressurized, and in the clockwise direction when the B port is pressurized. (Please note that the rotation direction is different from the existing MSQ.)
- By adjusting the adjustment bolt, the rotation end can be set within the ranges shown in the drawing.
- The rotating angle can also be set on the type with an internal shock absorber.
- Refer to page 24 for the tightening torques for setting the rotating angle.

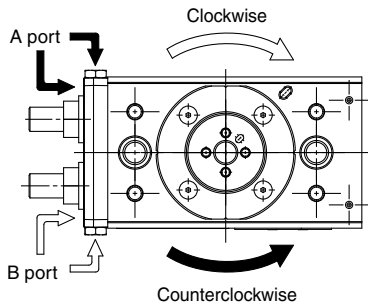

Adjustment bolt A
(For counterclockwise rotation end adjustment)

Adjustment bolt B
(For clockwise rotation end adjustment)

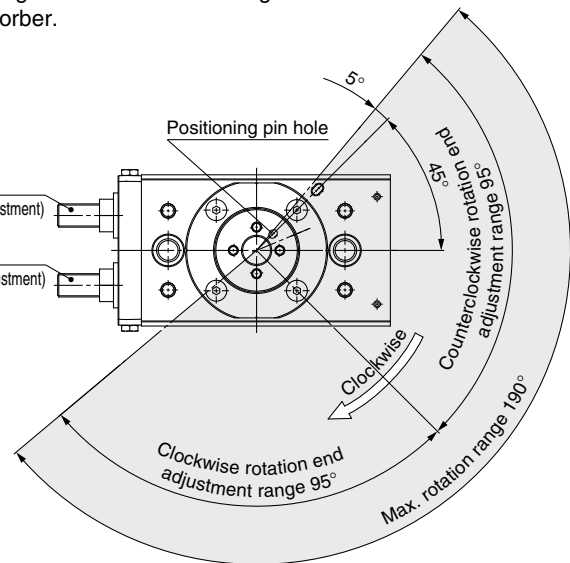

Rotation Direction and Rotating Angle (Cushion pad, Bumper, Internal shock absorber)

Size	Adjustment angle per rotation of adjustment bolt
10	8.0°
20	5.7°
30	5.7°
50	6.4°

Rotating Angle Range Examples

- Various rotation ranges are possible as shown in the drawings below using adjustment bolts A and B. (The drawings also show the rotation ranges of the positioning pin hole.)
- The rotating angle can also be set on the type with an internal shock absorber.

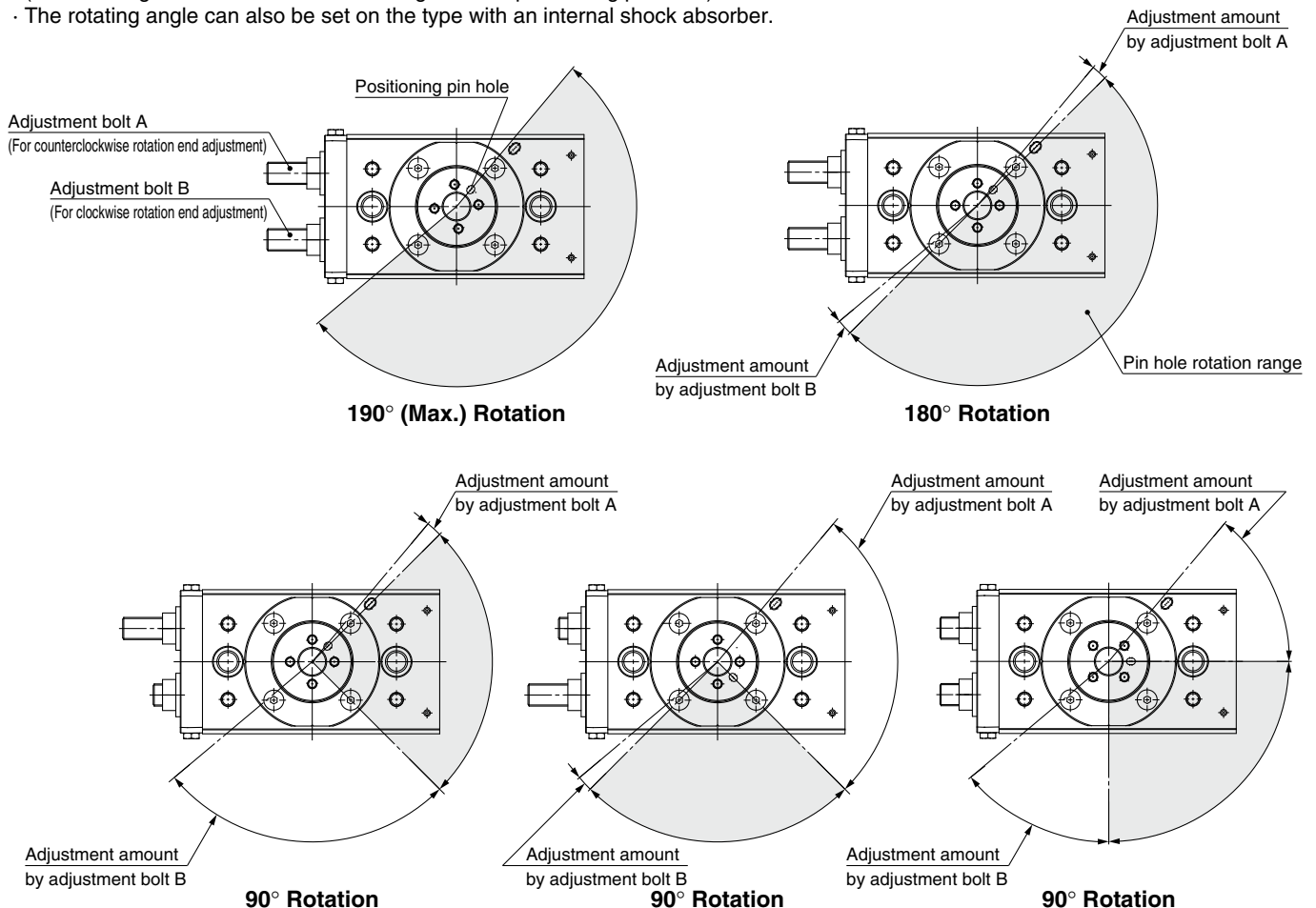
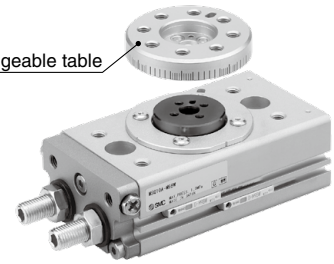
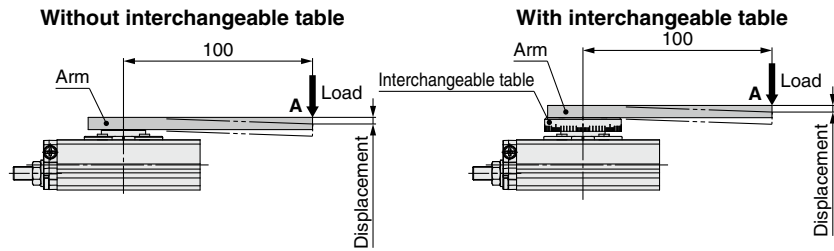
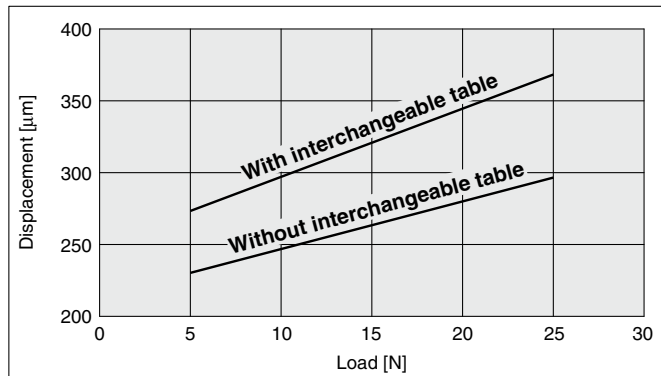

Table Displacement (Reference values)

The following graphs show the displacement at point A, which is 100 mm apart from the center of rotation, where the load is applied.



Size 10



Size 20

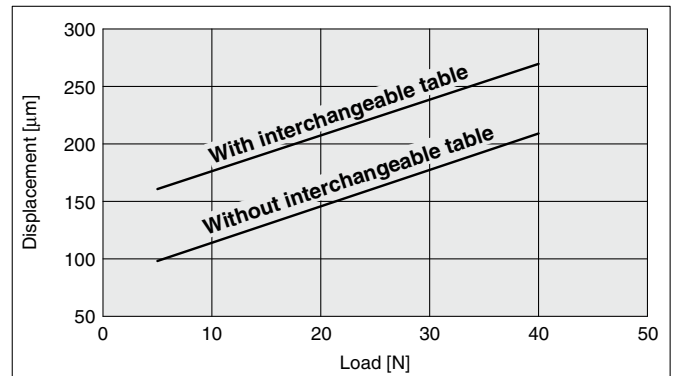

Size 30

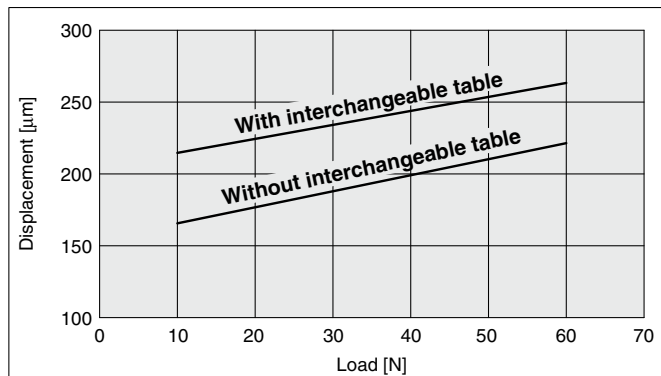

Size 50

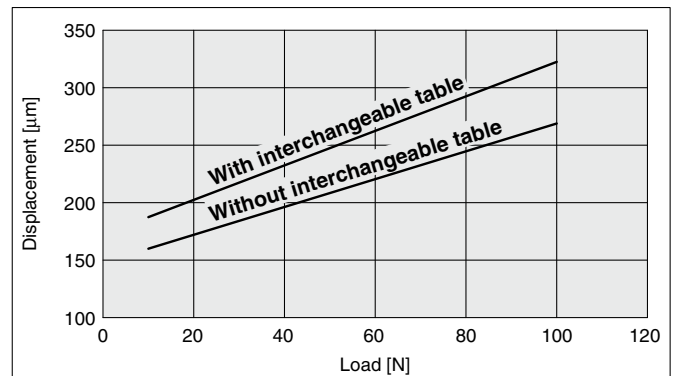

Deflection Accuracy: Displacement at 180° Rotation (Guide)

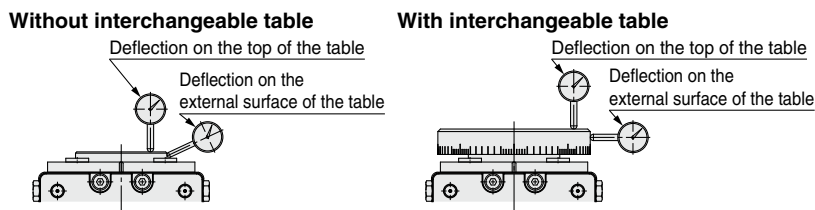

Measured part	[mm]	
	Without interchangeable table	With interchangeable table
Deflection on the top of the table	0.1	0.1
Deflection on the external surface of the table	0.1	0.1

Values in the table are actual values and not guaranteed values.

Working Principle

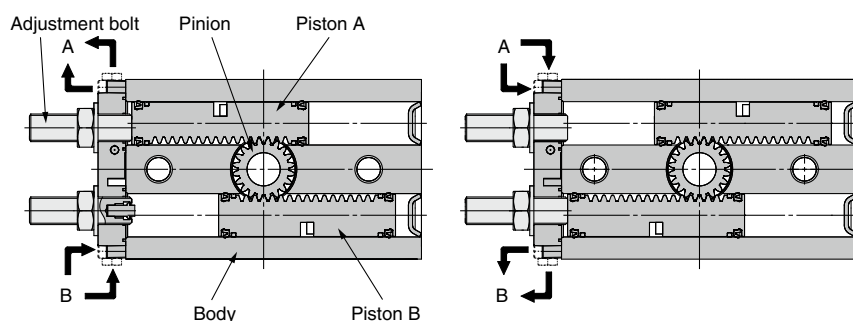

1. It consists of a rack that slides in 2 parallel cylinders, 2 pistons that are integrated with the rack, and a pinion.
2. The air that is supplied from port B pushes the left side of piston A; at the same time, it passes through the air passage of the body, pushing the right side of piston B, thus creating in the shaft an amount of torque that is equivalent to 2 pistons.
3. The air in the exhaust chamber discharges via port A and rotates clockwise.
4. The pinion stops when piston B comes in contact with the adjustment bolt and stops.
5. Similarly, when air is supplied from port A, it rotates counterclockwise.

MSQ Series

Construction

MSQ□R (Internal shock absorber)

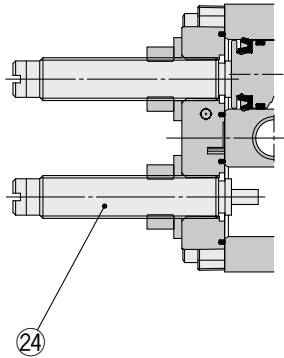

MSQ□A (Cushion pad) MSQ□D (Bumper)

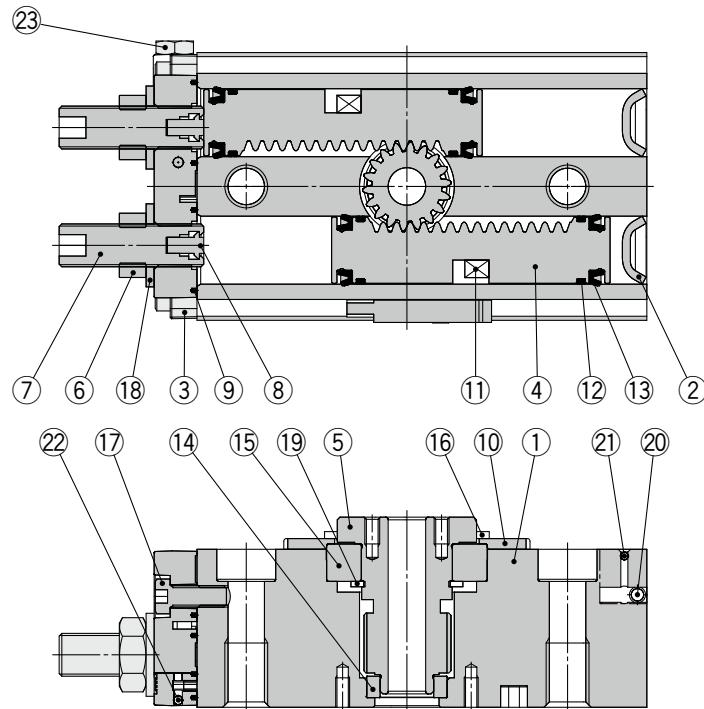

Component Parts

No.	Description	Material	Note
1	Body	Aluminum alloy	Anodized
2	Head cap	Aluminum alloy	Anodized
3	End cover	Aluminum alloy	Painted
4	Piston	Cushion pad	Aluminum alloy Anodized
		Bumper	Aluminum alloy Anodized
		Internal shock absorber	Stainless steel
5	Table pinion	Chrome molybdenum steel	
6	Compact hexagon nut	Steel wire	Chromating
7	Adjustment cushion pad bolt	Chrome molybdenum steel	Chromating
	Bumper	Chrome molybdenum steel	Nickel plating
8	Cushion pad	Rubber material	
	Bumper	Rubber material	
9	Gasket	NBR	
10	Bearing retainer	Aluminum alloy	Anodized
11	Magnet	—	
12	Wear ring	Resin	
13	Piston seal	NBR	
14	Bearing	Bearing steel	
15	Bearing	Bearing steel	
16	Hexagon socket super thin head cap screw	Steel wire	Chromating
17	Hexagon socket thin head cap screw	Steel wire	Chromating
18	Seal washer	Steel wire + NBR	
19	Round type S retaining ring	Steel wire	Phosphate coating
20	Steel ball	Stainless steel	
21	Steel ball	Stainless steel	
22	Steel ball	Stainless steel	
23	M5 plug assembly	Steel wire	Nickel plating
24	Shock absorber	—	

Replacement Parts

Seal Kit

Size	Part no.	Contents	
		Description	(Qty.)
10	P891010-5	⑨ Gasket	(1)
20	P891020-5	⑫ Wear ring	(4)
30	P891030-5	⑬ Piston seal	(4)
50	P891040-5	⑮ Seal washer	(2)

A grease pack (10 g) is included. Order with the following part number when only the grease pack is needed.

Grease pack part number: GR-L-010 (10 g)

Adjustment bolt assembly (Cushion pad)

Size	Part no.	Contents	
		Description	(Qty.)
10	P391010-3	⑦ Adjustment bolt (1) ⑧ Cushion pad (1)	
20	P391020-3		
50	P391040-3		

Two sets are required for each product.

Adjustment bolt assembly (Bumper)

Size	Part no.	Contents	
		Description	(Qty.)
10	P891010-3	⑦ Adjustment bolt (1) ⑧ Bumper (1)	
20	P891020-3		
30	P891020-3		
50	P891040-3		

Two sets are required for each product.

Shock absorber (Internal shock absorber)

Size	Part no.
10	RBA0805-X692
20	RBA1006-X692
30	RBA1006-X692
50	RBA1411-X692

Two units are required for each product.

⚠ Caution

The piston material differs between the types with a cushion pad, a bumper, and an internal absorber. Do not install a shock absorber on a product with a cushion pad or bumper as this may damage the piston.

Dimensions: Sizes 10, 20, 30, 50

Basic type/MSQ□^A_D

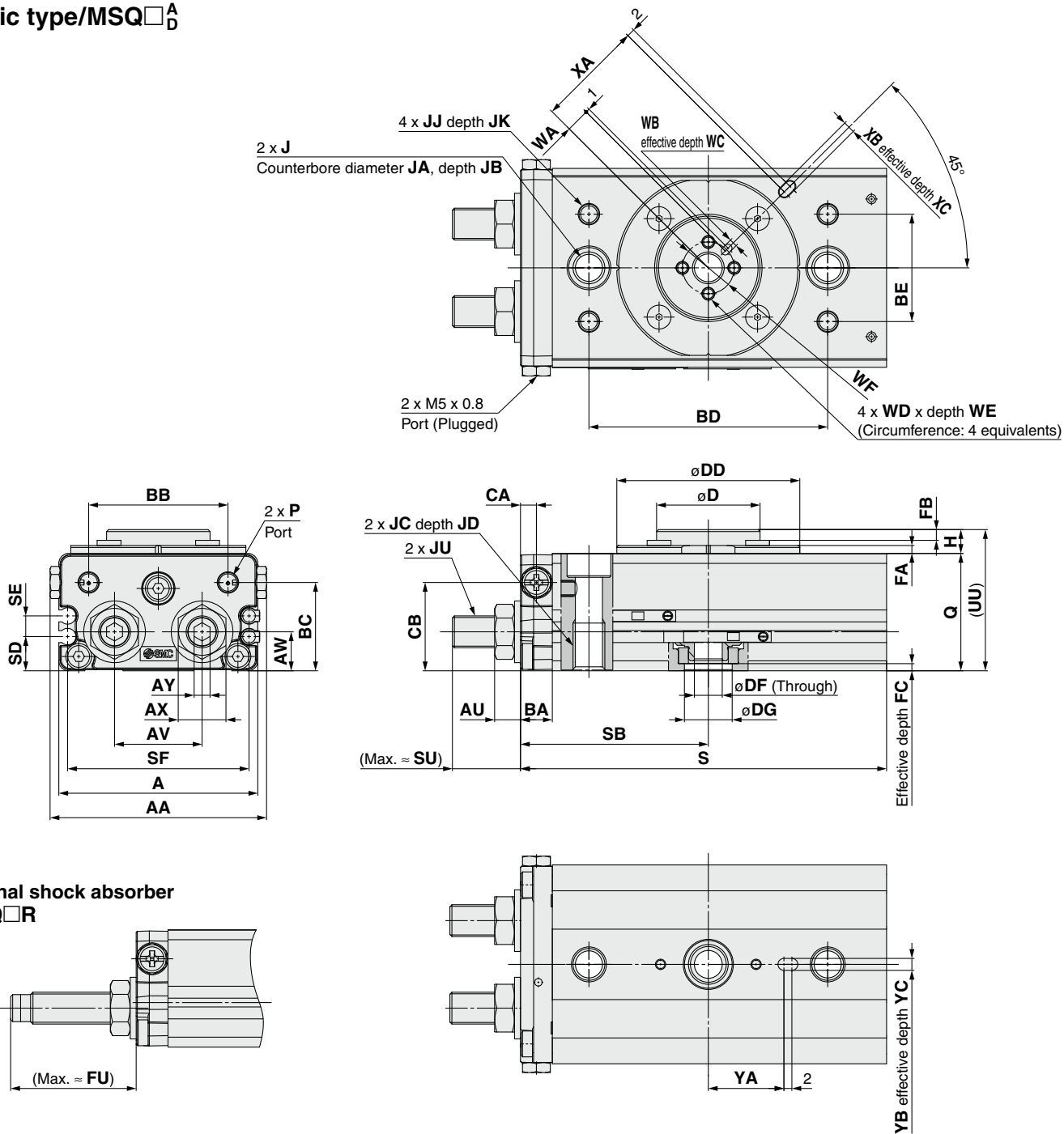

Internal shock absorber MSQ□^R

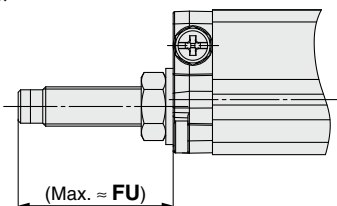

Size	AA	A	AU	AV	AW	AX	AY	BA	BB	BC	BD	BE	CA	CB	D	DD	DF	DG	FA	FB	FC	FU	H	J	JA	JB	JC	JD
10	54.4	50	6.6	22	9.8	12	4	8	35	22.2	60	27	4	22.2	26h9	46h9	7	12H9	2	2.7	1.3	32	6	6.8	11	6	M8 x 1.25	12
20	69.4	65	7.6	30	11.1	14	5	10	50.2	23.6	76	34	5	23.6	36h9	61h9	12	20H9	4	2.5	1.3	36	8	8.6	14	8.5	M10 x 1.5	15
30	74.4	70	7.6	36.5	13.8	14	5	12	49	30	84	37	6	31	41h9	67h9	13	20H9	4	2.5	2.3	34	8	8.6	14	8.5	M10 x 1.5	15
50	84.4	80	10	42	17.5	19	6	12	62	35	100	50	6	35	46h9	77h9	14	21H9	4.5	2.5	2.7	54	8.5	10.5	18	10.5	M12 x 1.75	18

Size	JJ	JK	JU	P	Q	S	SB	SD	SE	SF	SU*1	UU	WA	WB	WC	WD	WE	WF	XA	XB	XC	YA	YB	YC
10	M5 x 0.8	6	M8 x 1	M5 x 0.8	29.5	92	47.2	8.6	5.2	45.6	18	35.5	6	2H9	2.5	M3 x 0.5	5	13	27	3H9	3.5	19	3H9	3.5
20	M6 x 1	6	M10 x 1	M5 x 0.8	31	117	59.9	10.1	5.2	59.4	26	39	9.5	3H9	3.5	M4 x 0.7	7	20	36	4H9	4.5	24	4H9	4.5
30	M6 x 1	6	M10 x 1	Rc1/8*2	38	127	65.3	10.3	14	65	24	46	10.5	4H9	3.5	M5 x 0.8	9	22	39	4H9	4.5	28	4H9	4.5
50	M8 x 1.25	8	M14 x 1.5	Rc1/8*2	43	152	77.7	11.3	16	75	34	51.5	11.5	4H9	3.5	M6 x 1	10	24	45	5H9	5.5	33	5H9	5.5

*1 SU dimension is not the dimension at the time of shipment, since its dimension is for adjustment parts.

*2 In addition to Rc1/8, G1/8 and NPT1/8 are also available.

MSQ Series Auto Switch Mounting

Auto Switch Proper Mounting Position (at Rotation End Detection)

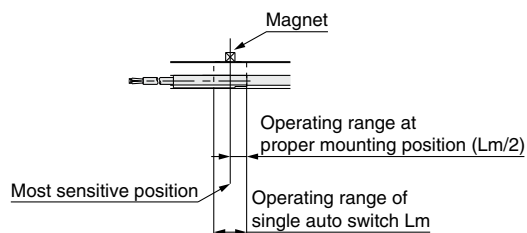
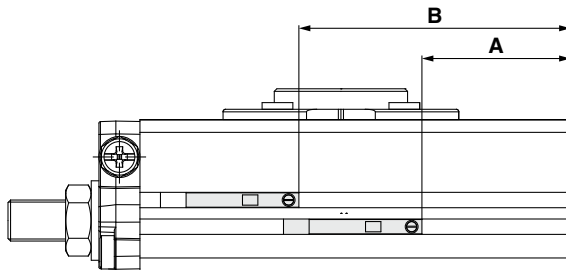
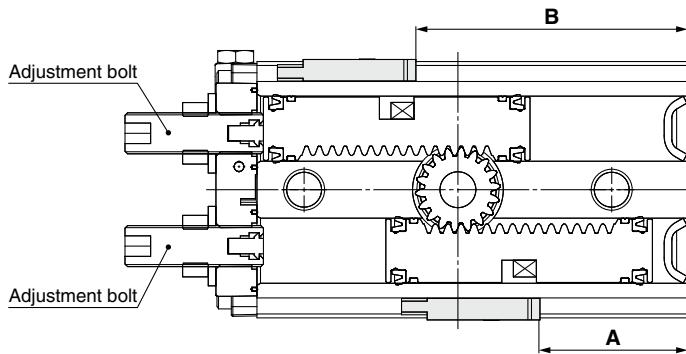

[mm]

Size	Rotating angle	Solid state auto switch D-M9□(V), D-M9□W(V)				Reed auto switch D-A9□, D-A9□V			
		A	B	Operating angle θ_m	Hysteresis angle	A	B	Operating angle θ_m	Hysteresis angle
10	180°	26 to 29	49 to 51	27°	3°	22 to 25	45 to 47	50°	4°
20	180°	34 to 37	66 to 68	21°	2°	30 to 33	62 to 64	42°	4°
30	180°	39 to 41	70 to 73	24°	2°	35 to 37	66 to 69	44°	4°
50	180°	46 to 48	88 to 91	19°	2°	42 to 44	84 to 87	31°	3°

Operating angle θ_m : Value of the operating range Lm of a single auto switch converted to an axial rotating angle

Hysteresis angle : Value of auto switch hysteresis converted to an angle

* : Since the figures in the table above are provided as a guideline only, they cannot be guaranteed. Adjust the auto switch after confirming the operating conditions in the actual setting.

· The values in the table above are the positions when the adjustment bolts (shock absorbers) are tightened in the same amount and adjusted to 180°.

· For the tightening torque of the set screw of the auto switch, refer to the operation manual of each auto switch.

Prior to Use

Auto Switch Connections and Examples

Sink Input Specifications

3-wire, NPN

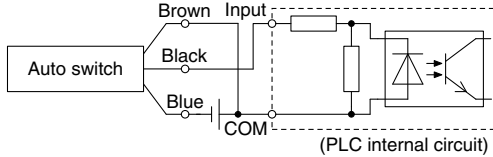

2-wire

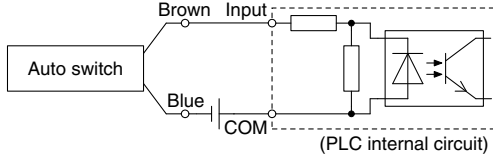

Source Input Specifications

3-wire, PNP

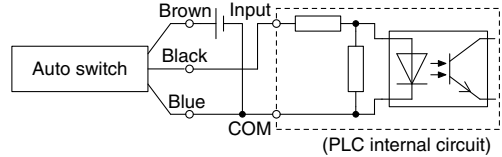

2-wire

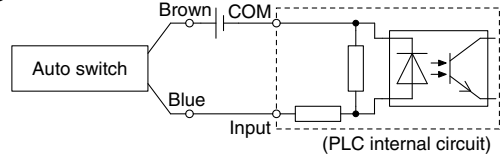

Connect according to the applicable PLC input specifications, as the connection method will vary depending on the PLC input specifications.

Examples of AND (Series) and OR (Parallel) Connections

* When using solid state auto switches, ensure the application is set up so the signals for the first 50 ms are invalid. Depending on the operating environment, the product may not operate properly.

3-wire AND connection for NPN output (Using relays)

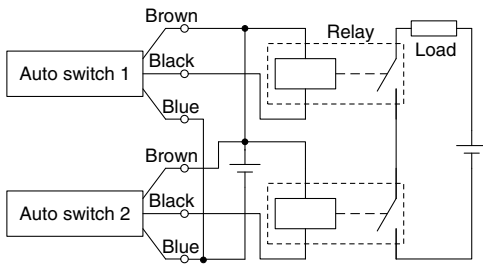

(Performed with auto switches only)

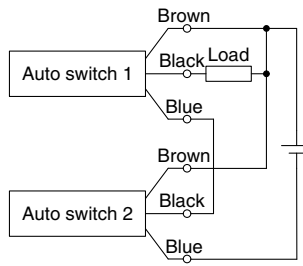

3-wire OR connection for NPN output

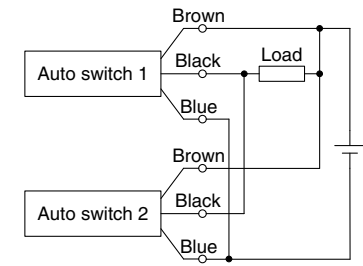

3-wire AND connection for PNP output (Using relays)

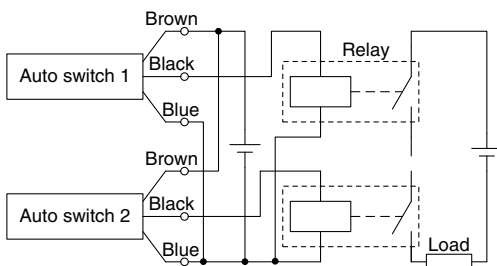

(Performed with auto switches only)

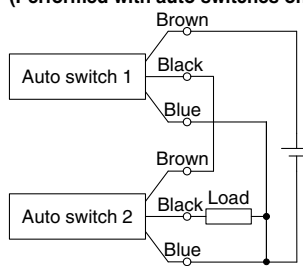

3-wire OR connection for PNP output

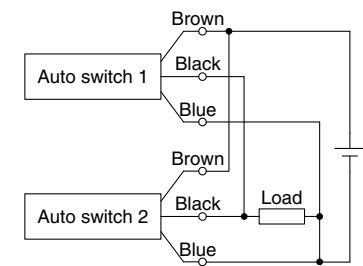

2-wire AND connection

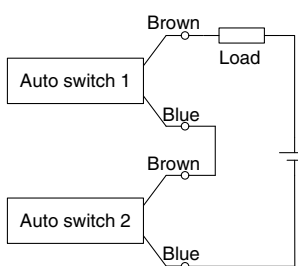

When two auto switches are connected in series, a load may malfunction because the load voltage will decline when in the ON state. The indicator lights will light up when both of the auto switches are in the ON state. Auto switches with a load voltage less than 20 V cannot be used. Please contact SMC if using AND connection for a heat-resistant solid state auto switch or a trimmer switch.

Example) Load voltage at ON
 Power supply voltage: 24 VDC
 Internal voltage drop: 4 V
 Load voltage at ON = Power supply voltage –
 Internal voltage drop x 2 pcs.
 = 24 V – 4 V x 2 pcs.
 = 16 V

2-wire OR connection

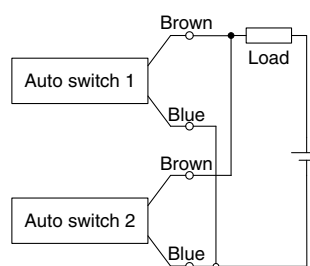

(Solid state)
 When two auto switches are connected in parallel, malfunction may occur because the load voltage will increase when in the OFF state.

(Reed)
 Because there is no current leakage, the load voltage will not increase when turned OFF. However, depending on the number of auto switches in the ON state, the indicator lights may sometimes grow dim or not light up, due to the dispersion and reduction of the current flowing to the auto switches.

Example) Load voltage at OFF
 Leakage current: 1 mA
 Load impedance: 3 kΩ
 Load voltage at OFF = Leakage current x 2 pcs. x
 Load impedance
 = 1 mA x 2 pcs. X 3 kΩ
 = 6 V

MSQ Series Made to Order

Please contact SMC for detailed dimensions, specifications, and delivery times.



1 With Interchangeable Table and Plate

Symbol
-A, -B, -C

How to Order

Standard model no. - **A**

Made to order

A	With interchangeable table and plate
B	With interchangeable table
C	With interchangeable plate

* An interchangeable table and plate can be ordered separately. For details, refer to the tables below.

* The interchangeable table and plate are assembled before shipment.

* Mounting diagram of the interchangeable table and plate
Dimensions other than those shown below are the same as those of the basic type. Refer to page 20.

Dimensions

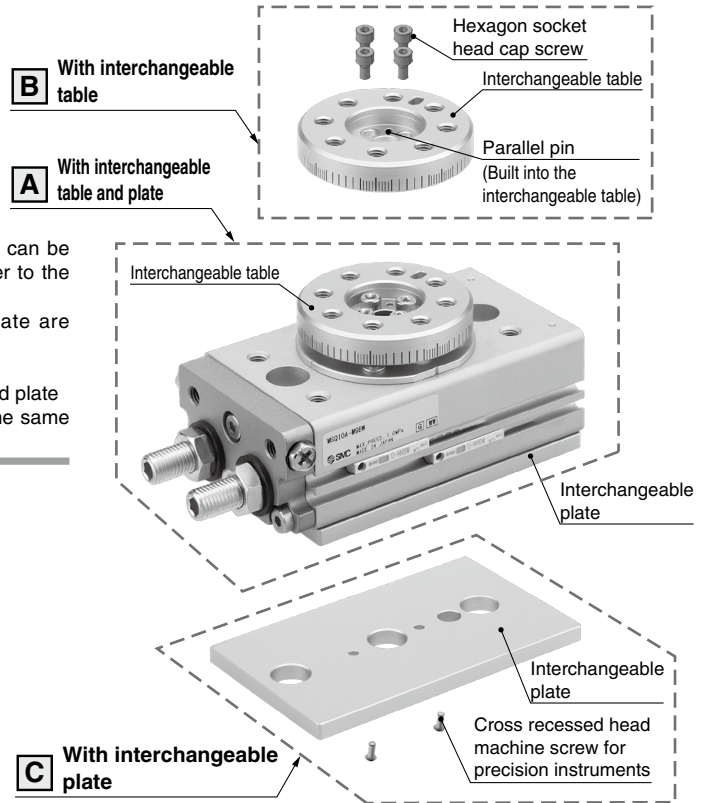
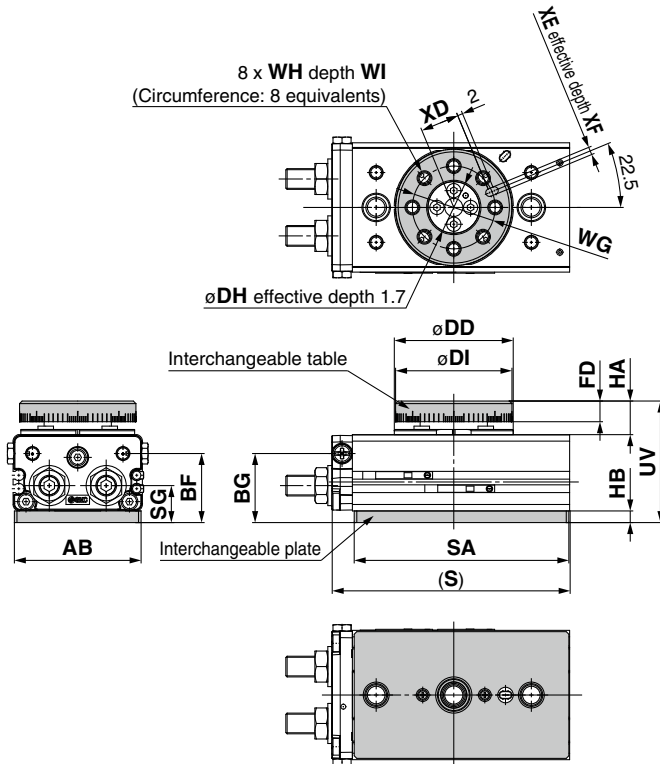

Size	AB	SG	BF	BG	DD	DH	DI	FD	HA	HB	[mm]
10	49	14.3	26.7	26.7	46h9	20H9	45h9	8	13	4.5	
20	64	17.1	29.6	29.6	61h9	28H9	60h9	10	17	6	
30	69	15.8	32	33	67h9	32H9	65h9	10	17	2	
50	79	20.5	38	38	77h9	35H9	75h9	12.5	20	3	

Size	S	SA	UV	WG	WH	WI	XD	XE	XF	[mm]
10	92	83	47	32	M5 x 0.8	8	15	3H9	3.5	
20	117	106	54	43	M6 x 1	10	20.5	4H9	4.5	
30	127	114	57	48	M6 x 1	10	23	4H9	4.5	
50	152	139	66	55	M8 x 1.25	12.5	26.5	5H9	5.5	

Part No. of Interchangeable Parts

Interchangeable A Unit (With Interchangeable Table and Plate)

Size	Part no.	Contents Description (Qty.)
10	P891010-50	· Interchangeable table (1)
20	P891020-50	· Parallel pin (1)
30	P891030-50	· Hexagon socket head cap screw (4)
50	P891040-50	· Interchangeable plate (1) · Cross recessed head machine screw for precision instruments (2)

Interchangeable B Unit (With Interchangeable Table)

Size	Part no.	Contents Description (Qty.)
10	P891010-51	· Interchangeable table (1)
20	P891020-51	· Parallel pin (1)
30	P891030-51	· Hexagon socket head cap screw (4)
50	P891040-51	· Interchangeable table (1)

Interchangeable C Unit (With Interchangeable Plate)

Size	Part no.	Contents Description (Qty.)
10	P891010-52	· Interchangeable plate (1)
20	P891020-52	· Cross recessed head machine screw for precision instruments (2)
30	P891030-52	· Cross recessed head machine screw for precision instruments (2)
50	P891040-52	· Cross recessed head machine screw for precision instruments (2)

* Refer to page 24 for the tightening torque of the interchangeable parts.



MSQ Series

Specific Product Precautions 1

Be sure to read this before handling the products. Refer to the back cover for safety instructions. For rotary actuator and auto switch precautions, refer to the “Handling Precautions for SMC Products” and the “Operation Manual” on the SMC website.

Speed Adjustment

⚠ Warning

1. To make a speed adjustment, gradually adjust starting from the low-speed end.

If the speed adjustment is performed from the high-speed end, damage to the product may result. This could pose a hazard to humans or damage the machinery and equipment.

⚠ Caution

1. When operating at a high speed with a large load, a large amount of energy is applied to the actuator, which can result in damage. Calculate the appropriate operation time by referencing the model selection procedure on page 4.
2. Do not machine the fixed orifice of the port to enlarge its size. If the fixed orifice size is enlarged, the actuator operating speed and impact force will increase, resulting in damage.
3. When using the product at the max. speed (around 0.02 s/90°), set the supply pressure to 0.3 MPa or more.

Lubrication

⚠ Caution

1. Use the product without lubrication.

This product is lubricated with grease at the factory, and further lubrication will result in a failure to meet the product’s specifications.

Effective Torque

⚠ Caution

1. The effective torque at the end of the rotation is half the effective torque generated during rotation. This is because one of the pistons of the double rack mechanism determines the angle by coming into contact with an adjustment bolt or shock absorber at the rotating end.

Rotating Angle Adjustment

⚠ Caution

1. As a standard feature, the rotary table is equipped with an angle adjustment mechanism (adjustment bolt or shock absorber) that can be used to adjust the rotating angle. Refer to page 17 for the rotation direction, rotating angle, and rotating angle range examples.
2. It might be difficult to adjust the angle using a tool due to the installation location of the product. If a special tool is required, refer to the operation manual.

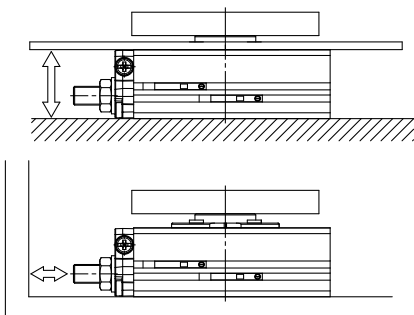

Rotating Angle Adjustment

⚠ Caution

3. Consider the full compression force when adjusting the rotating angle with bumper specifications.

You can use the bumper without fully compressing it, but if you need accuracy at the rotating end, consider the following methods:

1. Use at a min. operating pressure of 0.3 MPa or higher.
2. Use an external stopper (shock absorber).

The table below shows the angle at which the piston hits the bumper and compresses it completely. Note that the angle should only be used as a guide.

Size	Angle
10	16°
20	12°
30	12°
50	15°

Tightening Torque

1. Tighten the adjustment bolt or the hexagon nut for setting the shock absorber with the tightening torque shown in the table below.

Hexagon nut for setting the adjustment bolt or shock absorber

Adjustment bolt or shock absorber

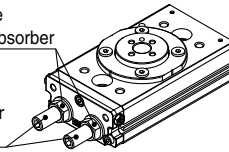

Size	Proper tightening torque [N·m]
10	1.00 to 1.67
20	1.88 to 3.14
30	
50	6.48 to 10.8

2. Tighten the screw for setting the interchangeable table and plate with the tightening torque shown in the table below.

Interchangeable table Hexagon socket head cap screw

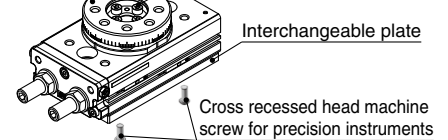

Size	Proper tightening torque [N·m]	
	Screw for setting interchangeable table	Screw for setting interchangeable plate
10	1.1 to 3.1	0.4 to 0.5
20	2.9 to 4.9	
30	4.9 to 6.9	
50	7.4 to 9.8	

* Refer to the operation manual for assembly procedures.

Kinetic Energy Absorption

⚠ Caution

1. This product has 3 types of cushion: a cushion pad, a bumper, and a shock absorber. They are not meant to achieve a smooth stopping operation but to absorb the load’s kinetic energy and prevent damage to the product. If the load has to be stopped smoothly, a shock absorber of the optimum size meeting the operating requirements must be installed externally.



MSQ Series Specific Product Precautions 2

Be sure to read this before handling the products. Refer to the back cover for safety instructions. For rotary actuator and auto switch precautions, refer to the “Handling Precautions for SMC Products” and the “Operation Manual” on the SMC website.

Mounting

⚠ Caution

1. When mounting the body, use screws of the appropriate length.

• Basic type



1. Top mounting (Through hole)

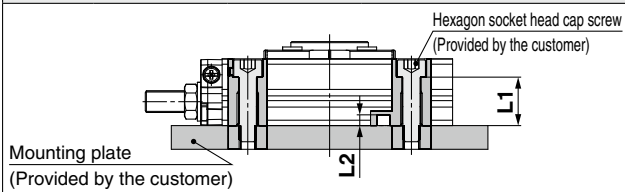

Size	L1		L2	
	Screw	Length [mm]	Pin [mm]	Effective depth [mm]
10	M6 x 1	23.5	ø3	3.5
20	M8 x 1.25	22.5	ø4	4.5
30	M8 x 1.25	29.5	ø4	4.5
50	M10 x 1.5	32.5	ø5	5.5

2. Bottom mounting (Body tapped)

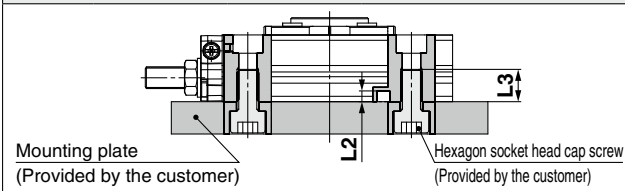

Size	L2		L3	
	Pin [mm]	Effective depth [mm]	Screw	Max. screw-in depth [mm]
10	ø3	3.5	M8 x 1.25	12
20	ø4	4.5	M10 x 1.5	15
30	ø4	4.5	M10 x 1.5	15
50	ø5	5.5	M12 x 1.75	18

3. Top mounting (Body tapped)

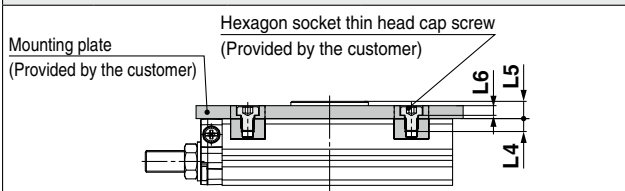

Size	L4		L5	L6
	Screw	Max. screw-in depth [mm]	Height [mm]	Counterbore depth [mm]
10	M5 x 0.8	6	6	3.9
20	M6 x 1	6	8	4.5
30	M6 x 1	6	8	4.5
50	M8 x 1.25	8	8.5	5.6

• With interchangeable plate

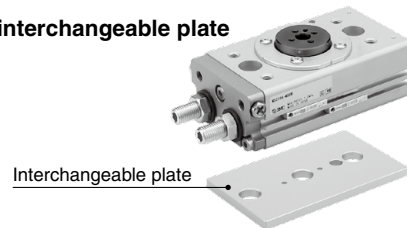

4. Top mounting (Through hole)

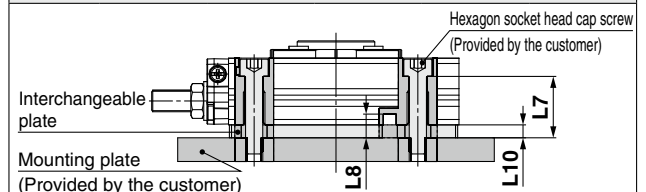

Size	L7		L8		L10
	Screw	Length [mm]	Pin [mm]	Depth*1 [mm]	Plate thickness [mm]
10	M6 x 1	28	ø3	8	4.5
20	M8 x 1.25	28.5	ø4	10.5	6
30	M8 x 1.25	31.5	ø4	6.5	2
50	M10 x 1.5	35.5	ø5	8.5	3

*1 The effective depth of the pin is the depth found by subtracting the plate thickness (L10) from the L8 depth.

* Refer to page 24 for the tightening torque of the interchangeable parts.

5. Bottom mounting (Body tapped)

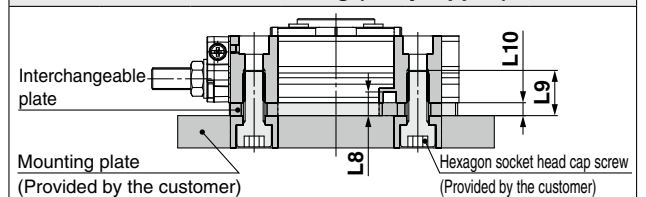

Size	L8		L9		L10
	Pin [mm]	Depth*1 [mm]	Screw	Max. screw-in depth [mm]	Plate thickness [mm]
10	ø3	8	M8 x 1.25	16.5	4.5
20	ø4	10.5	M10 x 1.5	21	6
30	ø4	6.5	M10 x 1.5	17	2
50	ø5	8.5	M12 x 1.75	21	3

*1 The effective depth of the pin is the depth found by subtracting the plate thickness (L10) from the L8 depth.

* Refer to page 24 for the tightening torque of the interchangeable parts.



MSQ Series

Specific Product Precautions 3

Be sure to read this before handling the products. Refer to the back cover for safety instructions. For rotary actuator and auto switch precautions, refer to the “Handling Precautions for SMC Products” and the “Operation Manual” on the SMC website.

Mounting

⚠ Caution

1. Keep away from objects which are influenced by magnets.

Since this product has a built-in magnet, do not allow close contact with magnetic disks, cards, or tapes. Data may be erased.

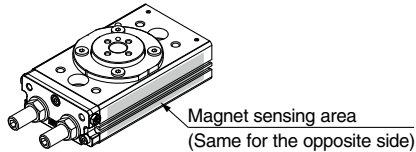

2. When using the center hole for piping, take care that the tube O.D., auto switch lead wire, etc., do not contact the mounting plate.

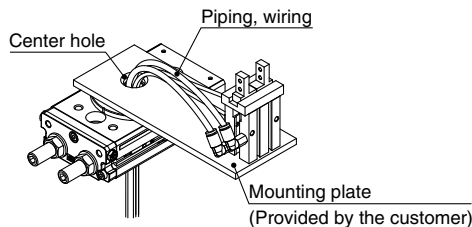

Shock Absorber

⚠ Caution

1. Never rotate the bottom screw of the shock absorber. (It is not an adjustment screw.) Failure to do so may result in oil leakage.

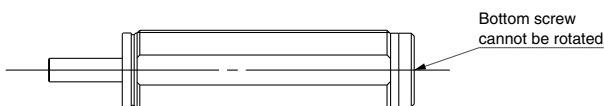

Service Life and Replacement Period of Shock Absorber

⚠ Caution

1. Shock absorbers are consumable parts.

When a decrease in energy absorption capacity is noticed, it must be replaced. Allowable operation time under the specifications set in this catalog is 1 million.

* Specified service life (suitable replacement period) is the value at room temperature (20 to 25°C). The period may vary depending on the temperature and other conditions. In some cases, the absorber may need to be replaced before the allowable operation time above.

Safety Instructions

These safety instructions are intended to prevent hazardous situations and/or equipment damage. These instructions indicate the level of potential hazard with the labels of “**Caution**,” “**Warning**” or “**Danger**.” They are all important notes for safety and must be followed in addition to International Standards (ISO/IEC)*1), and other safety regulations.

 **Caution:** **Caution** indicates a hazard with a low level of risk which, if not avoided, could result in minor or moderate injury.

 **Warning:** **Warning** indicates a hazard with a medium level of risk which, if not avoided, could result in death or serious injury.

 **Danger:** **Danger** indicates a hazard with a high level of risk which, if not avoided, will result in death or serious injury.

*1) ISO 4414: Pneumatic fluid power – General rules relating to systems.
ISO 4413: Hydraulic fluid power – General rules relating to systems.
IEC 60204-1: Safety of machinery – Electrical equipment of machines.
(Part 1: General requirements)
ISO 10218-1: Manipulating industrial robots – Safety.
etc.

Warning

1. The compatibility of the product is the responsibility of the person who designs the equipment or decides its specifications.

Since the product specified here is used under various operating conditions, its compatibility with specific equipment must be decided by the person who designs the equipment or decides its specifications based on necessary analysis and test results. The expected performance and safety assurance of the equipment will be the responsibility of the person who has determined its compatibility with the product. This person should also continuously review all specifications of the product referring to its latest catalog information, with a view to giving due consideration to any possibility of equipment failure when configuring the equipment.

2. Only personnel with appropriate training should operate machinery and equipment.

The product specified here may become unsafe if handled incorrectly. The assembly, operation and maintenance of machines or equipment including our products must be performed by an operator who is appropriately trained and experienced.

3. Do not service or attempt to remove product and machinery/equipment until safety is confirmed.

1. The inspection and maintenance of machinery/equipment should only be performed after measures to prevent falling or runaway of the driven objects have been confirmed.
2. When the product is to be removed, confirm that the safety measures as mentioned above are implemented and the power from any appropriate source is cut, and read and understand the specific product precautions of all relevant products carefully.
3. Before machinery/equipment is restarted, take measures to prevent unexpected operation and malfunction.

4. Contact SMC beforehand and take special consideration of safety measures if the product is to be used in any of the following conditions.

1. Conditions and environments outside of the given specifications, or use outdoors or in a place exposed to direct sunlight.
2. Installation on equipment in conjunction with atomic energy, railways, air navigation, space, shipping, vehicles, military, medical treatment, combustion and recreation, or equipment in contact with food and beverages, emergency stop circuits, clutch and brake circuits in press applications, safety equipment or other applications unsuitable for the standard specifications described in the product catalog.
3. An application which could have negative effects on people, property, or animals requiring special safety analysis.
4. Use in an interlock circuit, which requires the provision of double interlock for possible failure by using a mechanical protective function, and periodical checks to confirm proper operation.

Caution

1. The product is provided for use in manufacturing industries.

The product herein described is basically provided for peaceful use in manufacturing industries.
If considering using the product in other industries, consult SMC beforehand and exchange specifications or a contract if necessary.
If anything is unclear, contact your nearest sales branch.

Limited warranty and Disclaimer/ Compliance Requirements

The product used is subject to the following “Limited warranty and Disclaimer” and “Compliance Requirements”.

Read and accept them before using the product.

Limited warranty and Disclaimer

1. The warranty period of the product is 1 year in service or 1.5 years after the product is delivered, whichever is first.*2)
Also, the product may have specified durability, running distance or replacement parts. Please consult your nearest sales branch.
2. For any failure or damage reported within the warranty period which is clearly our responsibility, a replacement product or necessary parts will be provided.
This limited warranty applies only to our product independently, and not to any other damage incurred due to the failure of the product.
3. Prior to using SMC products, please read and understand the warranty terms and disclaimers noted in the specified catalog for the particular products.

*2) Vacuum pads are excluded from this 1 year warranty.

A vacuum pad is a consumable part, so it is warranted for a year after it is delivered.
Also, even within the warranty period, the wear of a product due to the use of the vacuum pad or failure due to the deterioration of rubber material are not covered by the limited warranty.

Compliance Requirements

1. The use of SMC products with production equipment for the manufacture of weapons of mass destruction (WMD) or any other weapon is strictly prohibited.
2. The exports of SMC products or technology from one country to another are governed by the relevant security laws and regulations of the countries involved in the transaction. Prior to the shipment of a SMC product to another country, assure that all local rules governing that export are known and followed.

Caution

SMC products are not intended for use as instruments for legal metrology.

Measurement instruments that SMC manufactures or sells have not been qualified by type approval tests relevant to the metrology (measurement) laws of each country. Therefore, SMC products cannot be used for business or certification ordained by the metrology (measurement) laws of each country.

Revision History

Edition B * A bumper (cushion) has been added.

ZP

Safety Instructions

Be sure to read the “Handling Precautions for SMC Products” (M-E03-3) and “Operation Manual” before use.