

Speed Controller: Standard Type In-line Type

AS Series



Compact size saves space.
Speed may be accurately controlled even at low speeds.
Constant speed easily set.
Retainer prevents an accidental loss of needle.



Symbol

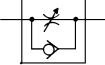

Caution

Be sure to read this before handling the products.
Refer to back page 50 for Safety Instructions and pages 543 to 546 for Flow Control Equipment Precautions.

Model/Flow Rate and Effective Area

Model	Port size	Free flow			Controlled flow			Weight (g)
		Flow rate (L/min (ANR))	Sonic conductance (dm ³ /(s bar))	Critical pressure ratio	Flow rate (L/min (ANR))	Sonic conductance (dm ³ /(s bar))	Critical pressure ratio	
AS1000-M3	M3 x 0.5	20	0.06	0.15	20	0.06	0.2	4.7
AS1000-M5	M5 x 0.8	90	0.25		80	0.22		33
AS2000-01	1/8	340	0.94	0.35	250	0.7	0.2	90
AS2000-02	1/4	340	0.94		250	0.7		115
AS3000-02	1/4	810	2.3		810	2.3		130
AS3000-03	3/8	810	2.3		810	2.3		124
AS4000-02	1/4	1,670	4.6		1,670	4.6		221
AS4000-03	3/8	1,670	4.6		1,670	4.6		214
AS4000-04	1/2	1,670	4.6		1,670	4.6		205
AS5000-02	1/4	2,840	7.9		2,840	7.9		242
AS5000-03	3/8	4,270	11.9		4,270	11.9		233
AS5000-04	1/2	4,270	11.9		4,270	11.9		224

Note) Flow rate values are measured at 0.5 Mpa and 20°C.

Specifications

Fluid	Air
Proof pressure (Note)	1.5 MPa (1.05 MPa)
Max. operating pressure (Note)	1 MPa (0.7 MPa)
Min. operating pressure (Note)	0.05 MPa (0.1 MPa)
Ambient and fluid temperature	-5 to 60°C (No freezing)

Note) (): Values for AS1000.

Accessory

Description	Part no.	Applicable model
Nipple	M-5N	AS1000

Note) AS1000 with nipple: AS1000-M5-N

How to Order

AS 1 000 - [] M5 - [] - []

Body size

1	M3, M5 standard
2	1/8, 1/4 standard
3	3/8 standard
4	1/2 standard
5	1/2 standard

Thread type

Nil	Metric thread (M3, M5)
	Rc
N	NPT
F	G

Lock nut option

Nil	Hexagon lock nut
J (3)	Round lock nut

Note 3) Only for AS1000

Option

H (1)	High temperature (-5 to 80°C)
L (2)	Low temperature (-30 to 60°C)

Note 1) AS5000 is available as special.
AS1000 is not applicable.
Note 2) AS1000, AS2000 are not applicable.

Bore size

Bore size	Applicable series
M3	M3 x 0.5 AS1000
M5	M5 x 0.8 AS1000
01	1/8 AS2000
02	1/4 AS2000, 3000, 4000, 5000
03	3/8 AS3000, 4000, 5000
04	1/2 AS4000, 5000

Needle Valve/Flow Rate Characteristics

Note) The flow rate characteristics are representative values.

AS1000-M3

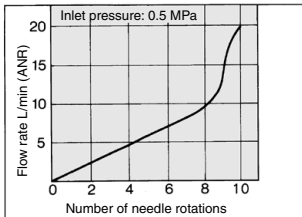

AS1000-M5

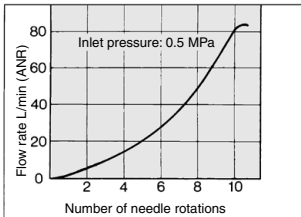

AS2000

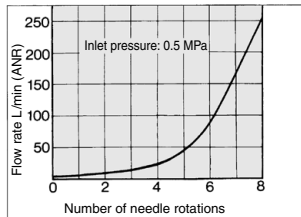

AS3000

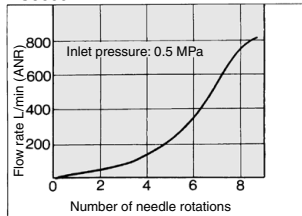

AS4000

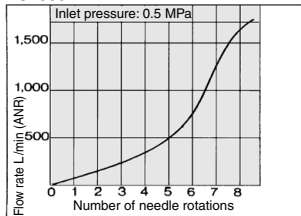

AS5000

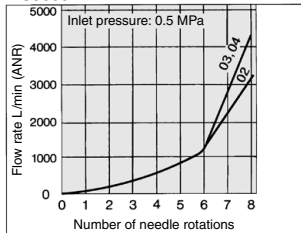

Construction: AS1000-M3

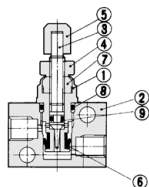

Component Parts

No.	Description	Material	Note
1	Body B	Brass	Electroless nickel plated
2	Body	Brass	Electroless nickel plated
3	Needle	Brass	Electroless nickel plated
4	Lock nut	Steel ^{Note)}	Zinc chromated
5	Handle	Brass	Electroless nickel plated
6	U seal	HNBR	
7	Needle guide	Brass	Electroless nickel plated
8	O-ring	NBR	4.5 x 3 x 0.75
9	O-ring	NBR	2.2 x 0.8 x 0.7

Note) Option: The round lock nut is made of electroless nickel plated brass.

Construction: AS1000-M5

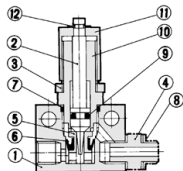

Component Parts

No.	Description	Material
1	Body	Zinc alloy
2	Needle	Stainless steel
3	Lock nut	Steel ^{Note)}
4	Nipple	Stainless steel

No.	Description	Material	Note
9	O-ring	NBR	
10	Needle guide	Brass	Electroless nickel plated
11	Handle	Brass	Electroless nickel plated
12	E type snap ring	Steel	

Note) Option: The round lock nut is made of electroless nickel plated brass.

Replacement Parts

No.	Description	Material	Part no.	Note
5	Valve seat	Brass	1429138	
6	U seal	HNBR	142964-3	
7	O-ring	NBR	KA00327	ø9 x ø7 x ø1
8	Gasket	NBR/Stainless steel	M-5G2	

Note) Construction drawing: AS1000-M5-N
In case of AS1000-M5, nipples and gaskets are not attached.

AS-F

TMH

ASD

AS

AS-FE

KE

AS-FG

AS-FP

AS-FM

AS-D

AS-T

ASP

ASN

AQ

ASV

AK

VCHC

ASR

ASQ

AS Series

Construction: AS2000/3000

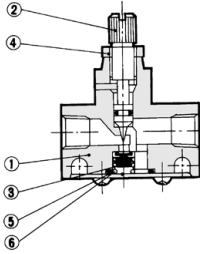

Component Parts

No.	Description	Parts no.	
		AS2000	AS3000
1	Body	Zinc alloy	Aluminum alloy
2	Needle *	Brass	Brass
4	Lock nut *	Brass	Carbon steel

* Electroless nickel plated

Replacement Parts

No.	Description	Material	Parts no.	
			AS2000	AS3000
3	Valve	NBR, Brass	143022	14283
5	O-ring	NBR	143021	14284
6	Spring	Stainless steel	143023	14282

Construction: AS4000

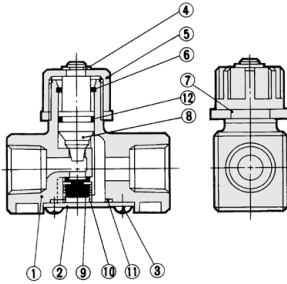

Component Parts

No.	Description	Material
1	Body	Aluminum alloy
2	Cap	Rolled steel
3	Cross-recessed head cap screw	Steel wire
4	E type snap ring	Stainless steel
5	Handle	Zinc alloy
6	Ring	Steel wire
7	Lock nut	Zinc alloy
8	Needle	Aluminum alloy
12	O-ring	NBR

Replacement Parts

No.	Description	Material	Parts no.
9	Valve	NBR, Brass	143145
10	Spring	Stainless steel	143146
11	O-ring	NBR	143147

Construction: AS5000

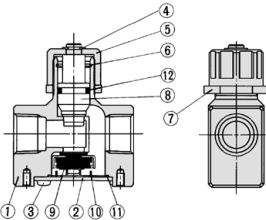

Component Parts

No.	Description	Material
1	Body	Aluminum alloy
2	Cap	Rolled steel
3	Cross-recessed head cap screw	Steel wire
4	E type snap ring	Stainless steel
5	Handle	Zinc alloy
6	Ring	Stainless steel
7	Lock nut	Zinc alloy
8	Needle	Aluminum alloy
12	O-ring	NBR

Replacement Parts

No.	Description	Material	Parts no.
9	Valve	NBR, Stainless steel	14143
10	Spring	Stainless steel	14144
11	Seal	NBR	14147

Dimensions: AS1000-M3

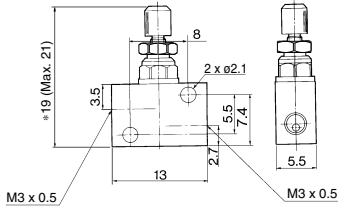

* Reference dimensions

Dimensions: AS1000-M5

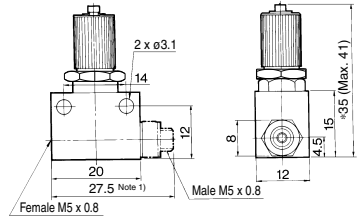

* Reference dimensions
Note 1) Dimension for AS1000-M5-N

Dimensions: AS2000/3000

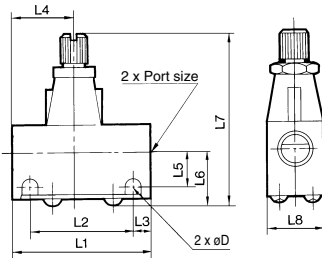

Dimensions

Model	Bore size	L1	L2	L3	L4	L5	L6	L7 (1)		L8	D
								Max.	Min.		
AS2000-01	Rc 1/8	40	30	5	17	10	15.5	54.5	50	16	4.5
AS2000-02	Rc 1/4	40	30	5	23	11.5	17	56	51.5	20	4.5
AS3000-02, 03	Rc 1/4, 3/8	56	45.5	5.25	25	13.2	20.6	68	61	26	5.5

Note 1) L7: Reference dimensions

Dimensions: AS4000

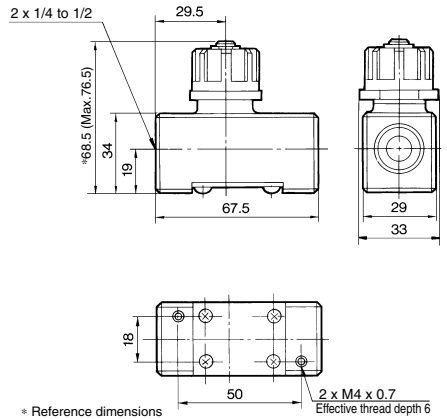

* Reference dimensions

Dimensions: AS5000

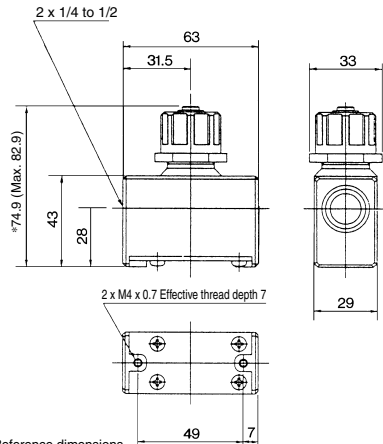

* Reference dimensions

- AS-F
- TMH
- ASD
- AS
- AS-FE
- KE
- AS-FG
- AS-FP
- AS-FM
- AS-D
- AS-T
- ASP
- ASN
- AQ
- ASV
- AK
- VCHC
- ASR
- ASQ