

Stroke Reading Cylinder with Brake

CE2 Series

ø40, ø50, ø63, ø80, ø100

Brake mechanism added
to a stroke reading cylinder
which can measure
stroke length.

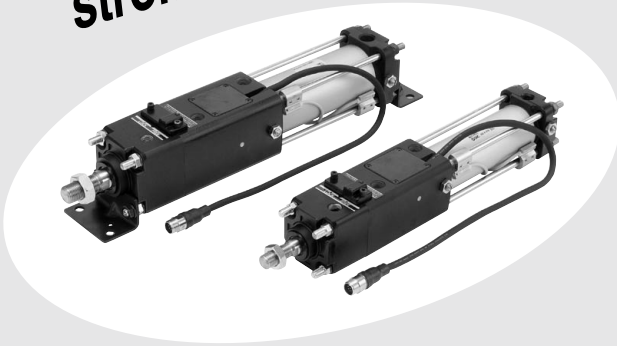

Controller/CEU2



D-
-X

Stroke Reading Cylinder with Brake/CE2 Controller/CEU2

A cylinder capable of highly reproducible positioning (stopping accuracy of ± 0.5 mm) has been created by adding a brake mechanism to a stroke reading cylinder which can measure stroke length.

Brake mechanism

Employs a combination spring and pneumatic lock type.

When there is a drop in air pressure, the workpiece is held by a spring lock.

Locking in both directions is possible.

Locking in either side of cylinder stroke is possible, too.

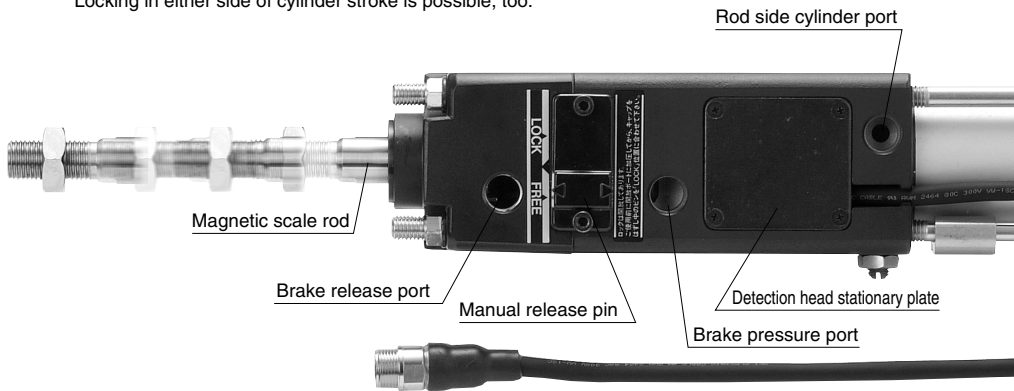

Working Principle of Brake Mechanism

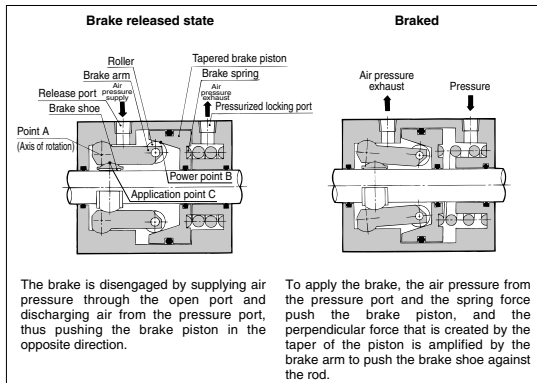

Measuring

Smallest measuring unit 0.1 mm

Magnetic scale rod and built-in detection head

Relation between displacement and output pulse on stroke reading cylinder

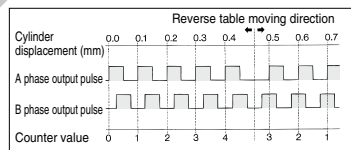

ø40, ø50, ø63, ø80, ø100

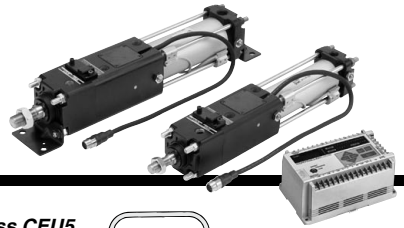

System configuration

For safety measures

Stroke reading cylinder with brake + Counter

- Prevents dropping from raised positions during intermediate stops.

Multi-counter: *Seriss CEU5*

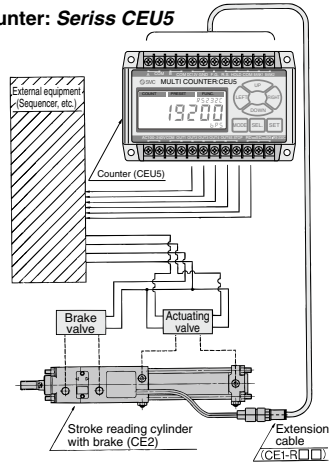

CEP1
CE1
CE2
ML2B

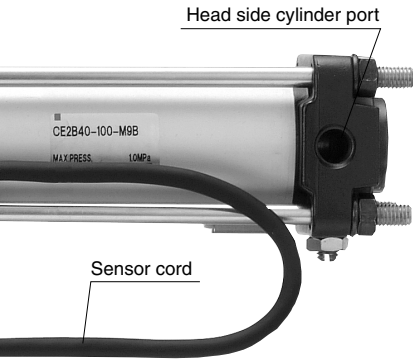

Controller: *CEU2 Series*

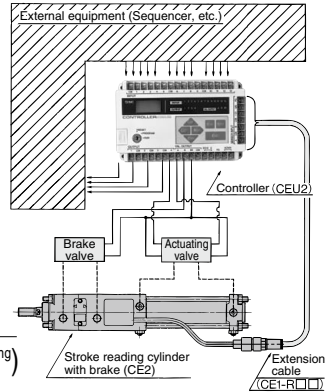

For precision positioning (Stopping accuracy ± 0.5 mm)

Stroke reading cylinder with brake + Controller (Brake positioning system)

- Positioning with high reproducibility has been achieved by prediction control and learning function.
- The stop position will be automatically redressed by re-try function.

Prediction control and learning function

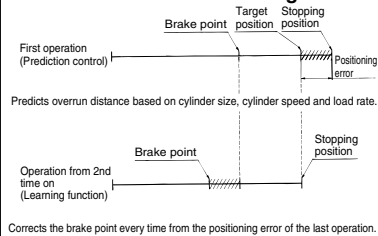

Application example

- For positioning of hole drilling**
This system can position the drill at the location in which a hole is to be drilled.
- For sorting workpieces**
Sorts workpieces by positioning the cylinder according to the workpiece.
- For placing workpieces in boxes**
By adopting an X-Y table configuration, the cylinder can position workpieces in boxes.

D-□
X-□

CE2 Series Prior to Use

Flow Chart to Confirm Utility of Stroke Reading Cylinder with Brake

Depending on the operating conditions, stable stopping accuracy may not be obtained. Therefore, make sure to follow the flow chart shown below.

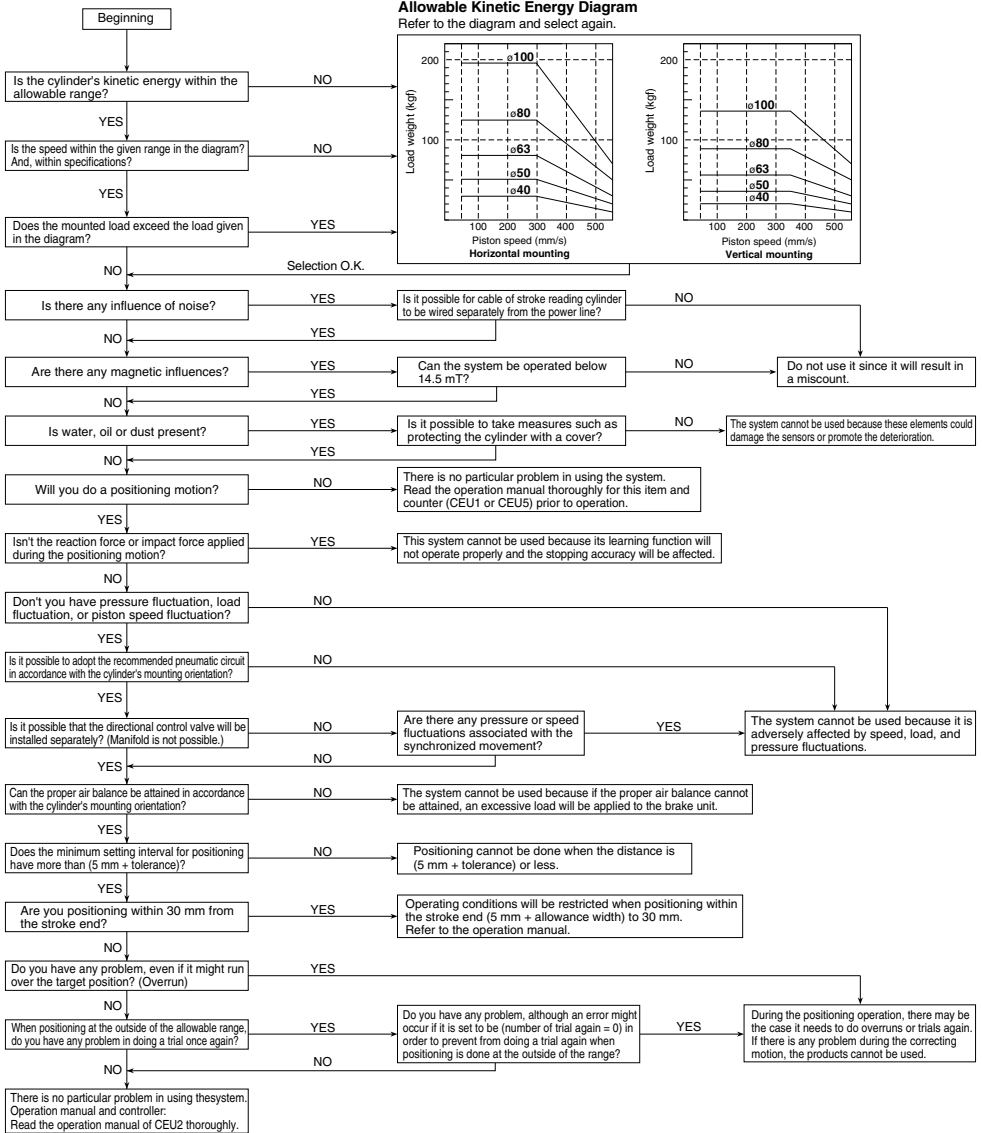

* This series cannot be used in an environment where it is exposed to fluids (water, oil, coolant, etc.)

Handling Technical Material

Be sure to read before handling brake positioning system (CE2 + CEU2).

Example of Recommended Pneumatic Circuit

Horizontal mounting

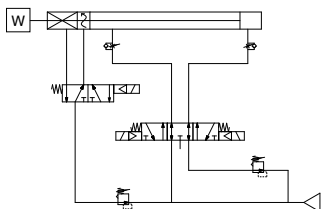

Vertical flat mounting

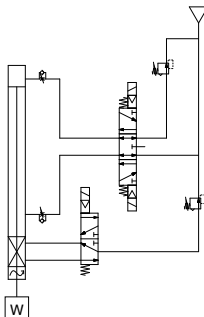

Vertical overhead mounting

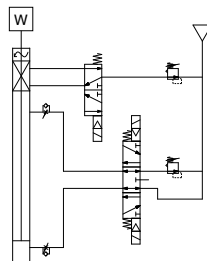

Note) In the case of light load, regulate head side supply pressure.
 * SMC original symbols are used for Stroke Reading Cylinder with Brake.

CEP1

CE1

CE2

ML2B

Recommended Pneumatic Equipment

Bore size (mm)	Directional control valve	Brake valve	Regulator	Piping	Silencer	Speed controller
ø40	VFS24□OR	VFS21□O	AR425	Nylon ø8/6 or larger	AN200-02	AS4000-02
ø50	VFS24□OR	VFS21□O	AR425	Nylon ø10/7.5 or larger	AN200-02	AS4000-02
ø63	VFS34□OR	VFS21□O	AR425	Nylon ø12/9 or larger	AN300-03	AS4000-03
ø80	VFS44□OR	VFS31□O	AR425	Nylon ø12/9 or larger	AN300-03	AS420-03
ø100	VFS44□OR	VFS31□O	AR425	Nylon ø12/9 or larger	AN400-04	AS420-04

Caution on Pneumatic Circuit Design

Air balance

Unlike the current pneumatic cylinder that performs a simple reciprocal movement, the stroke reading cylinder with a brake also makes intermediate stops. Thus, it must maintain the proper air balance in a stopped state.

Therefore, the proper air balance must be established in accordance with the mounting orientation of the cylinder.

Use caution the piston rod may be lunched when the next motion gets started after the intermediate stops or commence the operation after the reverse motion gets done, unless the air balance is taken. It may result in degrading its accuracy.

Supply pressure

If line pressure is used directly as supply pressure, any fluctuation in pressure will appear in the form of changes in cylinder characteristics. Therefore, make sure to use a pressure regulator to convert line pressure into supply pressure (Drive: 0.1 to 1 MPa, Brake: 0.3 to 0.5 MPa) for the actuating valve and the brake valve. In order to actuate multiple cylinders at once, use a pressure regulator that can handle a large air flow volume and also consider installing a surge tank.

D-□

-X□



CE2 Series Specific Product Precautions

Be sure to read this before handling the products.

Refer to back page 50 for Safety Instructions and pages 3 to 12 for Actuator and Auto Switch Precautions.

Sensor

⚠ Caution

Because a magnetic system is adopted in the sensor unit of the stroke reading cylinder with brake, the presence of a strong magnetic fields in the vicinity of the sensor could lead to a malfunction.

Operate the system with an external magnetic field of 14.5 mT.

This is equivalent to a magnetic field of approximately 18 cm in radius from a welding area using a welding amperage of almost 15,000 amperes. To use the system in a magnetic field that exceeds this value, use a magnetic material to shield the sensor unit.

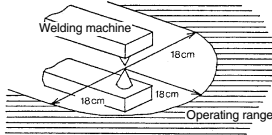

The sensor unit is adjusted to an appropriate position at the time of shipment. Therefore, never detach the sensor unit from the body. Make sure that water does not splash on the sensor unit (enclosure IP65). Do not pull on the sensor cable.

Noise

Operating the stroke reading cylinder with brake in the vicinity of equipment that generates noise, such as a motor or a welder, could result in miscounting. Therefore, minimize the generation of noise as much as possible, and keep the wiring separate.

Also, the maximum transmission distance of the stroke reading cylinder with brake is 20.5 m. Make sure that the wiring does not exceed this distance. Besides, when the transmission distance is over 20.5 m, use the dedicated transmission box (Part no. CE1-H0374).

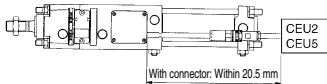

How to Manually Disengage the Lock and Change from the Unlocked to the Locked State

Manual unlocking

- Loosen the two hexagon socket head cap bolts and remove the pin guide.
- As viewed from the end of the rod, the pin is tilted 15° to the left of the center.
- Supply an air pressure of 0.3 MPa or more to the unlocking port.
- Rotate the pin 30° to the right with a wooden implement such as the grip of a wooden hammer or a resin stick without scratching.

How to manually change from an unlocked state to a locked state

- Loosen the two hexagon socket head cap bolts and remove the pin guide.
- As viewed from the end of the rod, the pin is tilted 15° to the right of the center.
- Supply air pressure of 0.3 MPa to the unlocking port.
- Rotate the pin 30° by pushing it with a wooden implement such as the grip of a wooden hammer or a resin stick.

(Note) Never rotate the pin by striking it since this may bend or damage the pin. Be careful when pushing the pin since the surface is slippery.

5. Inside the pin guide, there is a slotted hole that is slightly larger than the pin. Align the pin with the slotted hole and secure them to cover, using the hexagon socket head cap screws that were removed in step 1. The convex of the pin guide and "LOCK" on the locking condition indication plate will align.

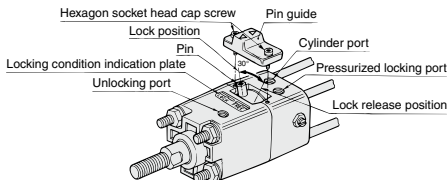

Caution on Handling

⚠ Caution

- Operate the cylinder in such a way that the load is always applied in the axial direction.

In case the load is applied in a direction other than the axial direction of the cylinder, provide a guide to constrain the load itself. In such a case, take precautions to prevent off-centering. If the piston rod and the load are off-centered, the speed of the movement of the piston could fluctuate, which could affect the piston's stopping accuracy and shorten the life of the brake unit.

- If there is a large amount of dust in the operating environment, use a cylinder with a bellows to prevent the intrusion of dust. Also, be aware that the operating temperature range is between 0 and 60°C.

- The brake unit and the cylinder rod cover area are assembled as shown in the diagram below. For this reason, unlike ordinary cylinders, it is not possible to use the standard type mounted directly onto a machine by screwing in the cylinder tie-rods.

Furthermore, when replacing mounting brackets, the unit holding tie-rods may get loosen. Tighten them once again in such a case.

Use a socket wrench when replacing mounting brackets or retightening the unit holding tie-rods.

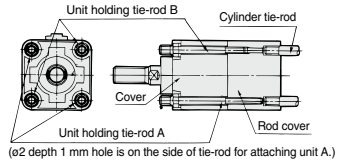

Bore size (mm)	Mounting bracket nut		Unit holding tie-rod	
	Nut	Socket	Width across flats	Socket
40	JIS B 1181 Class 3 M8 x 1.25	13	JIS B 4636 2 point angle socket 13	10 JIS B 4636 2 point angle socket 10
50	JIS B 1181 Class 3 M10 x 1.25	17	JIS B 4636 2 point angle socket 17	13 JIS B 4636 2 point angle socket 13
63	JIS B 1181 Class 3 M10 x 1.25	17	JIS B 4636 2 point angle socket 17	13 JIS B 4636 2 point angle socket 13
80	JIS B 1181 Class 3 M12 x 1.75	19	JIS B 4636 2 point angle socket 19	17 JIS B 4636 2 point angle socket 17
100	JIS B 1181 Class 3 M12 x 1.75	19	JIS B 4636 2 point angle socket 19	17 JIS B 4636 2 point angle socket 17

Operating Cautions

Counting speed of the counter

Be aware that if the speed of the stroke reading cylinder with brake is faster than the counting speed of the counter, the counter will miscount.

Use CEU2, CEU5.

Cylinder speed < Counting speed of the counter
(Cylinder speed 500 mm/sec = Counting speed of the counter 5 kcps)

Miscounting by lurching or bounding

If the stroke reading cylinder with brake lurches or bounds during an IN or OUT movement, or due to other factors, be aware that the cylinder speed could increase momentarily, possibly exceeding the counter's counting speed or the sensor's response speed, which could lead to miscounting.

Stroke Reading Cylinder with Brake

CE2 Series

ø40, ø50, ø63, ø80, ø100



(Note) CE-compliant: When connecting to a multi-counter (CEU5□□-D, power supply voltage 24 VDC). Refer to the counter operation manual for details.



How to Order

CE2 B 40 - **100** - **M9BW**

Mounting type

B	Basic type
L	Foot type
F	Rod side flange type
G	Head side flange type
C	Single clevis type
D	Double clevis type
T	Center trunnion type

Bore size

40	40 mm
50	50 mm
63	63 mm
80	80 mm
100	100 mm

Port thread type

Nil	Rc
TN	NPT
TF	G

Number of auto switches

Nil	2 pcs.
S	1 pc.
n	"n" pcs.

Applicable counter/Controller

CEU5 series
CEU2 series

Suffix for cylinder

Rod boot	J	Nylon tarpaulin
	K	Neoprene cross
Cushion	Nil	With cushion on both ends
	N	Without cushion
	R	With rod cushion
	H	With head cushion
Connector	Nil	With connector
	Z	Without connector

Auto switch

Nil	Without auto switch (Built-in magnet)
-----	---------------------------------------

* For the applicable auto switch model, refer to the table below.

Cylinder stroke (mm)
Refer to "Standard Stroke" on page 686.

Applicable Auto Switches

Refer to pages 941 to 1067 for further information on auto switches.

Type	Special function	Electrical entry	Indicator light	Wiring (Output)	Load voltage		Auto switch model		Lead wire length (m)				Pre-wired connector	Applicable load				
					DC	AC	Tie-rod mounting	Band mounting	0.5 (Nil)	1 (M)	3 (L)	5 (Z)		IC circuit	Relay, PLC			
Solid state auto switch	—	Grommet	—	3-wire (NPN)	24V	5 V, 12 V	—	M9N	●	●	●	○	—	IC circuit	—			
				3-wire (PNP)				—	G59	●	●	●				○		
		2-wire	12 V	—	G5P	●	●	●	○									
		2-wire		M9B	—	K59	●	●	○									
	Diagnostic indication (2-color indicator)	Terminal conduit	Yes	3-wire (NPN)	24V	5 V, 12 V	—	G39C	G39	—	—	—	—	—	IC circuit	Relay, PLC		
				3-wire (PNP)				—	K39C	K39	—	—	—				—	
	Water resistant (2-color indicator)	Grommet	—	—	2-wire	24V	12 V	—	M9NW	—	●	●	●	○	—	IC circuit	Relay, PLC	
					3-wire (NPN)				—	G59W	—	●	●	●				○
					3-wire (PNP)				—	G5PW	—	●	●	●				○
					2-wire				—	G5PW	—	●	●	●				○
With diagnostic output (2-color indicator)	Grommet	—	—	3-wire (NPN)	24V	5 V, 12 V	—	M9BW	—	●	●	●	○	—	IC circuit	Relay, PLC		
				3-wire (PNP)				—	K59W	—	●	●	●				○	
				2-wire				—	M9NA*1	—	○	○	○				○	
				3-wire (NPN)				—	M9PA*1	—	○	○	○				○	
				3-wire (PNP)				—	M9BA*1	—	○	○	○				○	
				2-wire				—	G5BA*1	—	●	●	●				○	
Reed auto switch	—	Grommet	Yes	3-wire (NPN equivalent)	24V	5 V	—	A96**	—	●	●	●	—	—	IC circuit	Relay, PLC		
				2-wire				12 V	100 V	A93**	—	●	●				●	—
				100 V or less					A90**	—	●	●	●				—	
				100 V, 200 V					A54	B54	●	—	●				—	
				200 V or less					A64	B64	●	—	●				—	
		Terminal conduit	Yes	—	—	2-wire	24V	12 V	—	A33C	A33	—	—	—	—	PLC	Relay, PLC	
						3-wire (NPN)				A34C	A34	—	—	—				
						3-wire (PNP)				A44C	A44	—	—	—				
						2-wire				A59W	B59W	●	—	●				—
						4-wire (NPN)				F59F	G59F	●	—	●				—

*1 Water resistant type auto switches can be mounted on the above models, but in such case SMC cannot guarantee water resistance. Consult with SMC regarding water resistant types with the above model numbers.

* Lead wire length symbols: 0.5 m..... Nil (Example) M9NW (Example) M9NWM (Example) M9NWL (Example) M9NWX

* Solid state auto switches marked with "○" are produced upon receipt of order. ** Since D-A9□ and D-A9□V cannot be mounted on ø50, use of D-Z7□ or D-Z80 is recommended.

* Since there are other applicable auto switches than listed, refer to page 697 for details.

* For details about auto switches with pre-wired connector, refer to pages 1014 and 1015.

* D-A9□/M9□/M9□W/M9□A(V) auto switches are shipped together (not assembled). (Only auto switch mounting brackets are assembled before shipped.)



CEP1
CE1
CE2
ML2B

D-□
-X□

CE2 Series

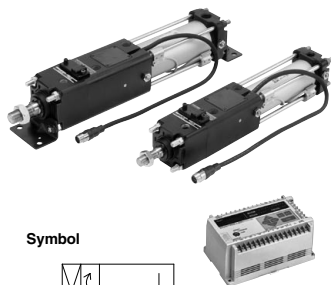

Symbol

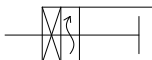

Model

Series	Type	Action	Bore size (mm)	Lock action
CE2	Non-lube	Double acting	40, 50, 63, 80, 100	Spring and pneumatic lock

Rod Boot Material

Symbol	Rod boot material	Maximum ambient temperature
J	Nylon tarpaulin	60°C
K	Neoprene cross	110°C*

* Maximum ambient temperature for the rod boot itself.

Refer to pages 692 to 697 for cylinders with auto switches.

- Auto switch proper mounting position (detection at stroke end) and its mounting height
- Operating range
- Minimum stroke for auto switch mounting
- Auto switch mounting brackets/Part no.

Cylinder Specifications

Bore size (mm)		ø40	ø50	ø63	ø80	ø100
Fluid		Air (Non-lube)				
Proof pressure	Drive	1.5 MPa				
	Brake	0.75 MPa				
Maximum operating pressure	Drive	1 MPa				
	Brake	0.5 MPa				
Minimum operating pressure	Drive	0.1 MPa				
	Brake	0.3 MPa				
Piston speed		50 to 500 mm/s*				
Ambient temperature		00 to 60°C (No freezing)				
Brake system		Spring and pneumatic lock type				
Sensor cord length		ø7-500 mm Oil-resistant				
Stroke length tolerance		Up to 250 mm: $\begin{smallmatrix} +1.0 \\ 0 \end{smallmatrix}$; 251 mm to 1000 mm $\begin{smallmatrix} +1.4 \\ 0 \end{smallmatrix}$				

* Be aware of the constraints in the allowable kinetic energy.

Sensor Specifications

Cable	ø7, 6 core twisted pair shielded wire (Oil, Heat and Flame resistant cable)
Maximum transmission distance	20.5 m (when using SMC cable while using controller or counter)
Position detection method	Magnetic scale rod/Sensor head <Incremental type>
Magnetic field resistance	14.5 mT
Power supply	10.8 to 26.4 VDC (Power supply ripple: 1% or less)
Current consumption	50 mA
Resolution	0.1 mm/pulse
Accuracy	± 0.2 mm (Note)
Output type	Open collector (Max. 35 VDC, 80 mA) (Note)
Output signal	A/B phase difference output
Insulation resistance	50 MΩ or more (500 VDC measured via megohmmeter) (between case and 12E)
Vibration resistance	33.3 Hz, 6.8 G, 2 hrs. each in X, Y directions, 4 hrs. in Z direction based upon JIS D 1601
Impact resistance	30 G, 3 times at X, Y, Z
Enclosure	IP65 (IEC standard) Except connector part
Extension cable (Option)	5 m, 10 m, 15 m, 20 m

(Note) Digital error under Controller (CEU2), Counter (CEU5) is included. Besides, the whole accuracy after mounting on an equipment may be varied depending on the mounting condition and surroundings. As an equipment, calibration should be done by customer.

Standard Stroke

Bore size (mm)	Standard stroke (mm)		Range of manufacturable stroke*	
	Without rod boot	With rod boot	Without rod boot	With rod boot
40	25 to 850	25 to 700	Up to 1200	Up to 950
50	25 to 800	25 to 650	Up to 1150	Up to 900
63	25 to 800	25 to 650	Up to 1150	Up to 900
80	25 to 750	25 to 600	Up to 1100	Up to 900
100	25 to 750	25 to 600	Up to 1100	Up to 850

* Strokes longer than the standard stroke are made-to-order products.

Weight

Bore size (mm)		40	50	63	80	100
Basic weight	Basic type	2.18	3.39	5.29	8.66	12.09
	Foot type	2.37	3.61	5.63	9.33	13.08
	Flange type	2.55	3.84	6.08	10.11	14.01
	Single clevis type	2.41	3.73	5.92	9.77	13.87
	Double clevis type	2.45	3.82	6.08	10.06	14.39
	Trunnion type	3.63	3.92	6.18	10.36	14.49
Additional weight per each 50 mm of stroke	Aluminum tube	0.22	0.28	0.37	0.52	0.65
	Mounting bracket					
Accessory bracket	Single knuckle	0.23	0.26	0.26	0.60	0.83
	Double knuckle	0.32	0.38	0.38	0.73	1.08
	Knuckle pin	0.05	0.05	0.05	0.14	0.19

Calculation example: CE2L40-100

- Basic weight:2.37 (Foot type, ø40)
 - Additional weight:0.22/50 stroke
 - Cylinder stroke:100 stroke
- 2.37 + 0.22 x 100/50 = 2.81 kg

Accessories

Mounting		Basic	Axial foot	Rod flange	Head flange	Single clevis	Double clevis	Center trunnion
Standard	Rod end nut	●	●	●	●	●	●	●
	Clevis pin	—	—	—	—	—	—	—
Option	Single knuckle joint	●	●	●	●	●	●	●
	Double knuckle joint (with pin)	●	●	●	●	●	●	●
	With rod boot	●	●	●	●	●	●	●

* Refer to page 690 for dimensions and part numbers of the option. Refer to page 688 for dimensions of the rod boot.

Construction

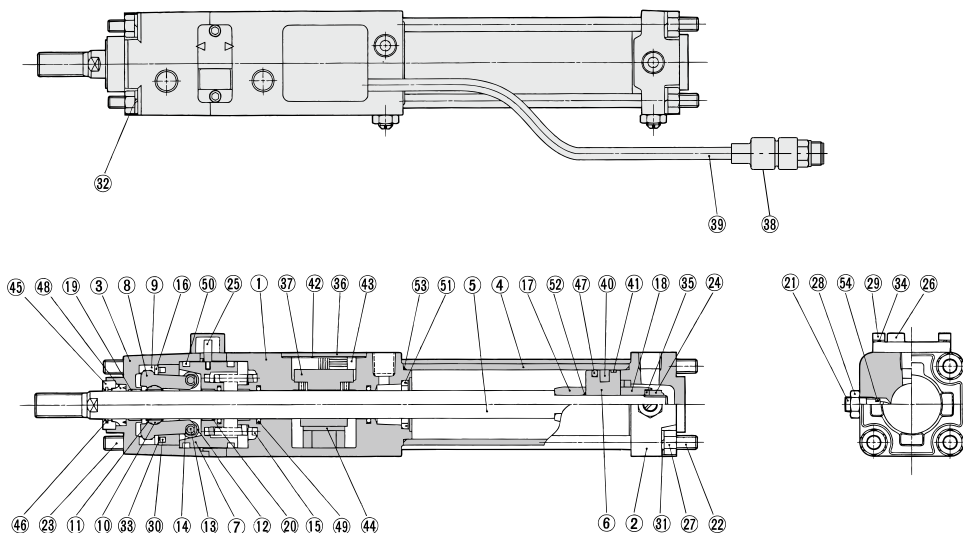

CEP1

CE1

CE2

ML2B

Component parts

No.	Description	Material	Note
1	Rod cover	Aluminum alloy	Black painted after hard anodized
2	Head cover	Aluminum alloy	Black painted
3	Cover	Aluminum alloy	Black painted after hard anodized
4	Cylinder tube	Aluminum alloy	Hard anodized
5	Piston rod	Free-cutting steel	Hard chrome plated
6	Piston	Aluminum alloy	Chromated
7	Brake piston	Carbon steel	Nitriding
8	Brake arm	Carbon steel	Nitriding
9	Brake arm holder	Carbon steel	Nitriding
10	Brake shoe holder	Carbon steel	Nitriding
11	Brake shoe	Special friction material	
12	Roller	Chromium molybdenum steel	Nitriding
13	Pin	Chrome bearing steel	Heat treated
14	Type E retaining ring	Stainless steel	JIS B 2805E
15	Brake spring	Steel wire	Dacrodized
16	Retaining plate	Rolled steel plate	Zinc chromated
17	Cushion ring A	Rolled steel	Electroless nickel plated
18	Cushion ring B	Rolled steel	Electroless nickel plated
19	Bushing	Lead-bronze casted	
20	Bushing	Lead-bronze casted	
21	Cushion valve	Rolled steel plate	Electroless nickel plated
22	Tie-rod	Carbon steel	Chromated
23	Unit holding tie-rod	Carbon steel	Chromated
24	Piston nut	Rolled steel plate	Zinc chromated
25	Non-rotating pin	Carbon steel	High frequency quenched
26	Pin guide	Carbon steel	Black painted after nitriding
27	Tie-rod nut	Carbon steel	Black zinc chromated

No.	Description	Material	Note
28	Lock nut	Carbon steel	Nickel plated
29	Hexagon socket head cap screw	Chromium molybdenum steel	Black zinc chromated
30	Hexagon socket head cap screw	Stainless steel	
31	Spring washer	Steel wire	Black zinc chromated
32	Spring washer	Steel wire	Black zinc chromated
33	Spring washer	Steel wire	Black zinc chromated
34	Spring washer	Steel wire	Black zinc chromated
35	Spring washer	Steel wire	Zinc chromated
36	Sensor cover	Carbon steel	
37	Detection head assembly	—	
38	Connector	—	
39	Cable	—	
40	Rubber magnet	NBR	
41	Wear ring	Resin	
42	Gasket	NBR	
43	Bushing	NBR	
44	Amp cushion	NBR	
45	Seal retainer	Aluminum alloy	
46	Coil scraper	Phosphor bronze	
47	Piston seal	NBR	
48	Rod seal A	NBR	
49	Rod seal B	NBR	
50	Brake piston seal	NBR	
51	Cushion seal	NBR	
52	Piston gasket	NBR	
53	Cylinder tube gasket	NBR	
54	Cushion valve seal	NBR	

D-□

-X□

CE2 Series



Dimensions: $\varnothing 40$ to $\varnothing 100$

Basic type

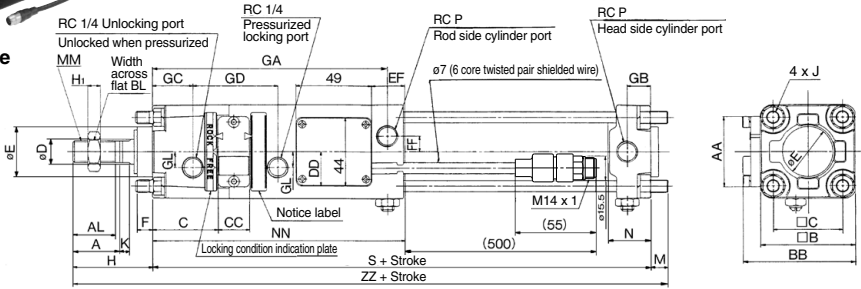

With rod boot

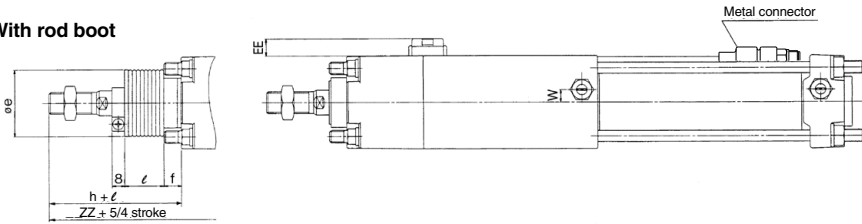

Bore size (mm)	Stroke range																										
	Without rod boot	With rod boot	A	AA	AL	BB	BL	B	C	CC	C	DD	D	EF	EE	E	F	FF	GA	GB	GC	GD	GL	H ₁	J	K	M
40	25 to 850	25 to 700	30	45	27	71.5	22	60	42	20	44	22	16	21	11.5	32	10	10	150.5	15	26	54	10	8	M8 x 1.25	6	11
50	25 to 800	25 to 650	35	50	32	80.5	27	70	46	21	52	24	20	28.5	10.5	40	10	12	162.5	17	27	59	13	11	M8 x 1.25	9	11
63	25 to 800	25 to 650	35	60	32	98.5	27	85	48.5	23	64	24	20	28.5	13.5	40	10	15	174	17	26	67	18	11	M10 x 1.25	9	14
80	25 to 750	25 to 600	40	70	37	117.5	32	102	55	23	78	26.5	25	36	15.5	52	14	17	189	21	30	72	23	13	M12 x 1.75	11	17
100	25 to 750	25 to 600	40	80	37	131.5	41	116	56.5	25	92	35.5	30	36	15.5	52	14	19	198	21	31	76	25	16	M12 x 1.75	11	17

Bore size (mm)	MM	N	NN	P	S	W	Without rod boot		With rod boot				
							H	ZZ	e	f	h	1/4 stroke	ZZ
40	M14 x 1.5	27	161.5	1/4	218.5	8	51	280.5	43	11.2	59		288.5
50	M18 x 1.5	30	175.5	3/8	235.5	0	58	304.5	52	11.2	66	312.5	
63	M18 x 1.5	31	187	3/8	254	0	58	326	52	11.2	66	334	
80	M22 x 1.5	37	205	1/2	284	0	71	372	65	12.5	80	381	
100	M26 x 1.5	40	214	1/2	300	0	72	389	65	14	81	398	

Foot type

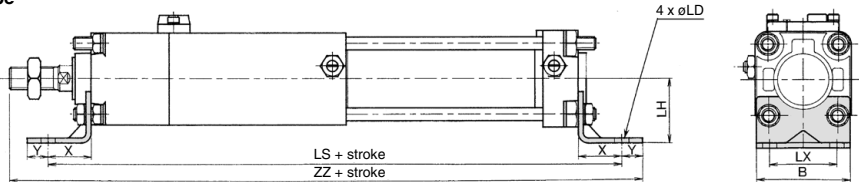

Bore size (mm)	B	LH	LS	LX	X	Y	ZZ	LD
40	58.5	40	272.5	42	27	13	309.5	9
50	68.5	45	289.5	50	27	13	333.5	9
63	83	50	322	59	34	16	362	11.5
80	100	65	372	76	44	16	415	13.5
100	114	75	386	92	43	17	432	13.5

Rod side flange type

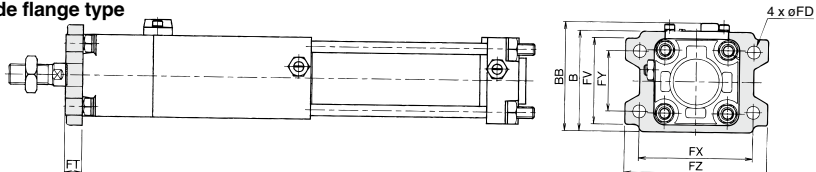

Head side flange type

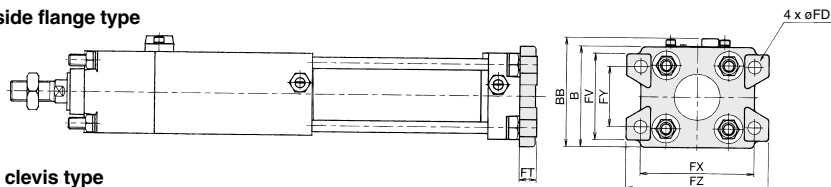

Single clevis type

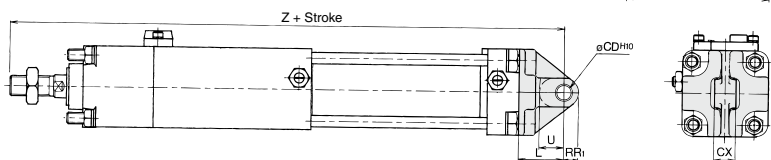

Double clevis type

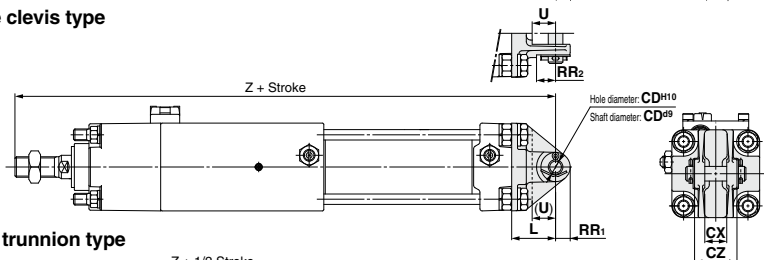

Center trunnion type

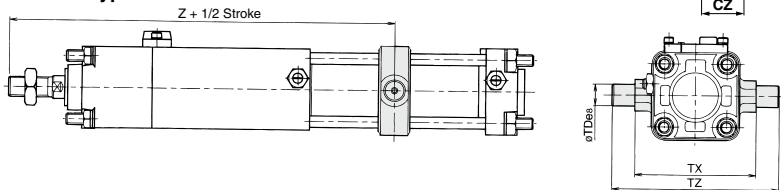

(mm)

Bore size (mm)	Rod side flange, Head side flange					Rod side flange		Single clevis, Double clevis					Single clevis			Double clevis			Center trunnion		
	FT	FV	FX	FY	FZ	FD	B	BB	CD ^{H10}	L	RR ₁	RR ₂	U	Z	CX	CX	CZ	TD8	TX	TZ	Z
40	12	60	80	42	100	9	71	77	10 ^{+0.058} / ₀	30	10	16	16	299.5	15 ^{-0.3} / _{-0.3}	15 ^{-0.3} / _{-0.3}	29.5	15 ^{-0.032} / _{-0.059}	85	117	227.5
50	12	70	90	50	110	9	81	86	12 ^{+0.070} / ₀	35	12	19	19	328.5	18 ^{-0.1} / _{-0.3}	18 ^{-0.3} / _{-0.1}	38	15 ^{-0.032} / _{-0.059}	95	127	248.5
63	15	86	105	59	130	11.5	101	107	16 ^{+0.070} / ₀	40	16	23	23	352	25 ^{-0.1} / _{-0.3}	25 ^{-0.3} / _{-0.1}	49	18 ^{-0.032} / _{-0.059}	110	148	263
80	18	102	130	76	160	13.5	119	126	20 ^{+0.084} / ₀	48	20	28	28	403	31.5 ^{-0.1} / _{-0.3}	31.5 ^{+0.3} / _{-0.1}	61	25 ^{-0.040} / _{-0.073}	140	192	297
100	18	116	150	92	180	13.5	133	140	25 ^{+0.084} / ₀	58	25	23.5	36	430	35.5 ^{-0.1} / _{-0.3}	35.5 ^{+0.3} / _{-0.1}	64	25 ^{-0.040} / _{-0.073}	162	214	309

Mounting Bracket Part No.

Bore size (mm)	40	50	63	80	100
Foot*	CA1-L04	CA1-L05	CA1-L06	CA1-L08	CA1-L10
Flange	CA1-F04	CA1-F05	CA1-F06	CA1-F08	CA1-F10
Single clevis	CA1-C04	CA1-C05	CA1-C06	CA1-C08	CA1-C10
Double clevis**	CA1-D04	CA1-D05	CA1-D06	CA1-D08	CA1-D10

* When ordering foot type brackets, 2 pcs. should be ordered for each cylinder.

** Clevis pin, flat washer and cotter pin are shipped together with double clevis type.

CE2 Series

Allowable Kinetic Energy

Operate the stroke reading cylinder with brake within the proper allowable kinetic energy. It must not be operated out of the allowable range, which is shown in the graph on the right. All sizes must be operated within this range. (Supply pressure 0.5 MPa)

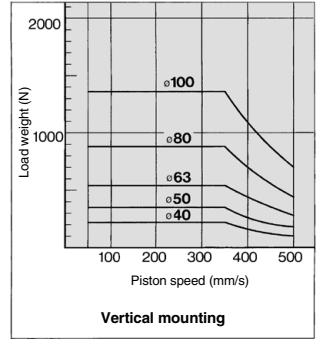
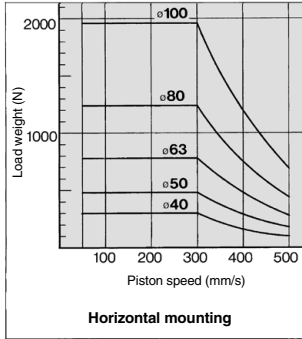

Dimensions of Accessories

Y Type Double Knuckle Joint

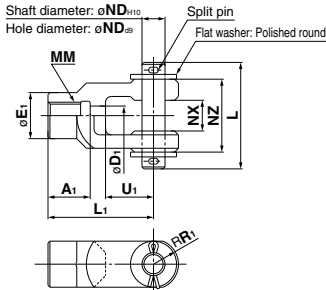

Material: Cast iron (mm)

Part no.	Applicable bore size	A ₁	E ₁	D ₁	L ₁	MM	R ₁	U ₁	ND	NX	NZ	L	Split pin size	Flat washer size
Y-04D	40	22	24	10	55	M14 x 1.5	13	25	12	16 ^{+0.3} / _{+0.1}	38	55.5	ø3 x 18 L	Polished round 12
Y-05D	50, 63	27	28	14	60	M18 x 1.5	15	27	12	16 ^{+0.3} / _{+0.1}	38	55.5	ø3 x 18 L	Polished round 12
Y-08D	80	37	36	18	71	M22 x 1.5	19	28	18	28 ^{+0.3} / _{+0.1}	55	76.5	ø4 x 25 L	Polished round 18
Y-10D	100	37	40	21	83	M26 x 1.5	21	38	20	30 ^{+0.3} / _{+0.1}	61	83	ø4 x 30 L	Polished round 20

* A knuckle pin, split pins and flat washers are included.

Clevis Pin/Knuckle Pin

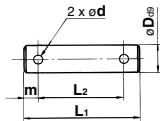

Material: Carbon steel (mm)

Part no.	Applicable bore size		Dd9	L ₁	L ₂	m	d	Included split pin	Included flat washer
	Clevis	Knuckle							
CDP-2A	40	—	10 ^{-0.040} / _{-0.076}	46	38	4	3	ø3 x 18 L	Polished round 10
CDP-3A	50	40, 50, 63	12 ^{-0.050} / _{-0.093}	55.5	47.5	4	3	ø3 x 18 L	Polished round 12
CDP-4A	63	—	16 ^{-0.050} / _{-0.093}	71	61	5	4	ø4 x 25 L	Polished round 16
CDP-5A	—	80	18 ^{-0.050} / _{-0.093}	76.5	66.5	5	4	ø4 x 25 L	Polished round 18
CDP-6A	80	100	20 ^{-0.065} / _{-0.117}	83	73	5	4	ø4 x 30 L	Polished round 20
CDP-7A	100	—	25 ^{-0.065} / _{-0.117}	88	78	5	4	ø4 x 36 L	Polished round 24

* Split pins and flat washers are included.

I Type Single Knuckle Joint

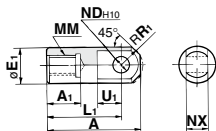

Material: Free cutting sulfur steel (mm)

Part no.	Applicable bore size	A	A ₁	E ₁	L ₁	MM	R ₁	U ₁	ND _{H10}	NX
I-04A	40	69	22	24	55	M14 x 1.5	15.5	20	12 ^{+0.070} / ₀	16 ^{-0.1} / _{-0.3}
I-05A	50, 63	74	27	28	60	M18 x 1.5	15.5	20	12 ^{+0.070} / ₀	16 ^{-0.1} / _{-0.3}
I-08A	80	91	37	36	71	M22 x 1.5	22.5	26	18 ^{+0.070} / ₀	28 ^{-0.1} / _{-0.3}
I-10A	100	105	37	40	83	M26 x 1.5	24.5	28	20 ^{+0.084} / ₀	30 ^{-0.1} / _{-0.3}

Rod End Nut (Standard)

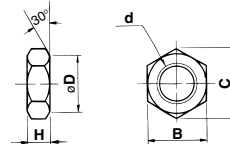

Material: Rolled steel (mm)

Part no.	Applicable bore size	d	H	B	C	D
NT-04	40	M14 x 1.5	8	22	25.4	21
NT-05	50, 63	M18 x 1.5	11	27	31.2	26
NT-08	80	M22 x 1.5	13	32	37.0	31
NT-10	100	M26 x 1.5	16	41	47.3	39

Auto Switch Mounting 1

Auto Switch Proper Mounting Position (Detection at Stroke End) and Its Mounting Height

<Band mounting>

D-B5□/B64/B59W

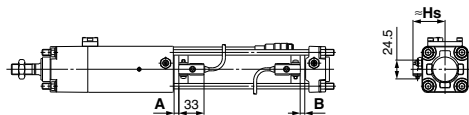

D-A3□
D-G39/K39

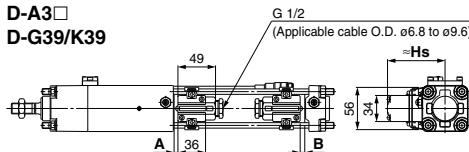

D-G5□/K59
D-G5□W/K59W
D-G5BA
D-G59F/G5NT

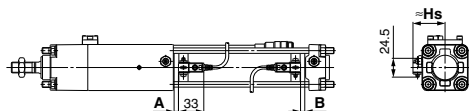

D-A44

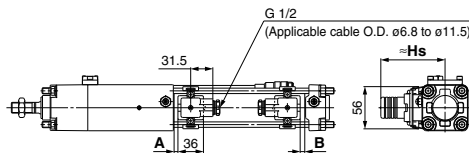

<Tie-rod mounting>

D-A9□/A9□V D-Z7□/Z80
D-M9□/M9□V D-Y59□/Y69□/Y7P/Y7PV
D-M9□W/M9□WV D-Y7□W/Y7□WV
D-M9□A/M9□AV D-Y7BA

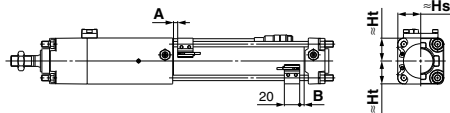

D-A5□/A6□
D-A59W

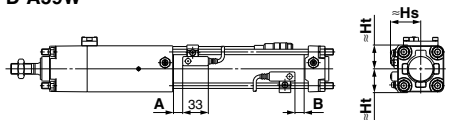

D-A3□C
D-G39C/K39C

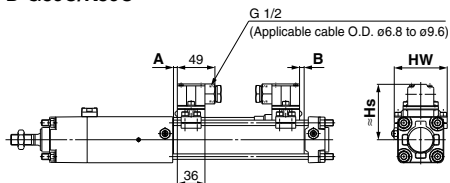

D-F5□/J59
D-F5NT
D-F5□W/J59W
D-F5BA/F59F

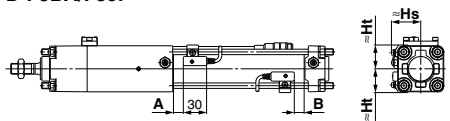

D-A44C

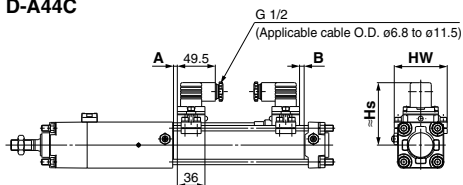

Auto Switch Proper Mounting Position (Detection at Stroke End) and Its Mounting Height

Auto Switch Proper Mounting Position

(mm)

Auto switch model Bore size (mm)	D-A9□ D-A9□V		D-M9□ D-M9□V D-M9□W D-M9□WV D-M9□A D-M9□AV		D-B59W D-Z7□ D-Z80 D-Y59□ D-Y69□ D-Y7P D-Y7PV D-Y7□W D-Y7□WV D-Y7BA		D-A5□ D-A6□ D-A3□ D-A3□C D-A44 D-A44C D-G39 D-G39C D-K39 D-K39C		D-B5□ D-B64		D-F5□ D-J59 D-F59F D-F5□W D-J59W D-F5BA		D-G5□ D-K59 D-G5NT D-G5□W D-K59W D-G5BA D-G59F		D-A59W		D-F5NT	
	A	B	A	B	A	B	A	B	A	B	A	B	A	B	A	B	A	B
40	6	4	10	8	3.5	1.5	0	0	0.5	0	6.5	4.5	2	0	4	2	11.5	9.5
50	—	—	10	8	3.5	1.5	0	0	0.5	0	6.5	4.5	2	0	4	2	11.5	9.5
63	8.5	7.5	12.5	11.5	6	5	2.5	1.5	3	2	9	8	4.5	3.5	6.5	5.5	14	13
80	12	10	16	14	9.5	7.5	6	4	6.5	4.5	12.5	8	6	10	8	17.5	15.5	
100	13.5	12.5	17.5	16.5	11	10	7.5	6.5	8	7	14	13	9.5	8.5	11.5	10.5	19	18

* D-A9□ and D-A9□V cannot be mounted on ø50.
Note) Adjust the auto switch after confirming the operating conditions in the actual setting.

CEP1
CE1
CE2
ML2B

Auto Switch Mounting Height

(mm)

Auto switch model Bore size (mm)	D-A9□ D-M9□ D-M9□W D-M9□A		D-A9□V		D-M9□V D-M9□WV D-M9□AV		D-Z7□ D-Z80 D-Y59□ D-Y7P D-Y7BA D-Y7□W		D-Y69□ D-Y7PV D-Y7□WV		D-B5□ D-B64 D-B59W D-G5□ D-K59 D-G5NT D-G5□W D-K59W D-G5BA D-G59F		D-A3□ D-G39 D-K39		D-A44		D-A5□ D-A6□ D-A59W		D-F5□ D-J59 D-F5□W D-J59W D-F5BA D-F59F D-F5NT		D-A3□C D-G39C D-K39C		D-A44C	
	Hs	Ht	Hs	Ht	Hs	Ht	Hs	Ht	Hs	Ht	Hs	Ht	Hs	Ht	Hs	Ht	Hs	Ht	Hs	Ht	Hs	Hw	Hs	Hw
40	30	30	32	30	35	30	30	30	30	30.5	30	38	72.5	80.5	40	31	38.5	31	73	69	81	69		
50	34	34	36.5	34	39	34	34	34	35	34	43.5	78	86	43.5	35	42.5	35	78.5	77	86.5	77			
63	41	41	43.5	41	46	41	41	41	42.5	41	50.5	85	93	49	42	48	42	85.5	91	93.5	91			
80	49.5	49	51.5	49	54	49	49.5	48.5	51	48.5	59	93.5	101.5	55.5	50	54	50	94	107	102	107			
100	57	56	59.5	56	62.5	56	58.5	56	59	56	69.5	104	112	63	57.5	62	57.5	104	121	112	121			

* D-A9□ and D-A9□V cannot be mounted on ø50.

D-□
-X□

Minimum Auto Switch Mounting Stroke

Auto switch model	No. of auto switch mounted	Mounting brackets other than center trunnion	Center trunnion				
			ø40	ø50	ø63	ø80	ø100
D-A9□	2 (Different surfaces, Same surface) 1	15	75	—	80	85	90
	n	$15 + 40 \frac{(n-2)}{2}$ (n = 2, 4, 6, 8 ...) ^{Note 1)}	$75 + 40 \frac{(n-4)}{2}$ (n = 4, 8, 12, 16 ...) ^{Note 2)}		$80 + 40 \frac{(n-4)}{2}$ (n = 4, 8, 12, 16 ...) ^{Note 2)}	$85 + 40 \frac{(n-4)}{2}$ (n = 4, 8, 12, 16 ...) ^{Note 2)}	$90 + 40 \frac{(n-4)}{2}$ (n = 4, 8, 12, 16 ...) ^{Note 2)}
D-A9□V	2 (Different surfaces, Same surface) 1	10	50	—	55	60	65
	n	$10 + 30 \frac{(n-2)}{2}$ (n = 2, 4, 6, 8 ...) ^{Note 1)}	$50 + 30 \frac{(n-4)}{2}$ (n = 4, 8, 12, 16 ...) ^{Note 2)}		$55 + 30 \frac{(n-4)}{2}$ (n = 4, 8, 12, 16 ...) ^{Note 2)}	$60 + 30 \frac{(n-4)}{2}$ (n = 4, 8, 12, 16 ...) ^{Note 2)}	$65 + 30 \frac{(n-4)}{2}$ (n = 4, 8, 12, 16 ...) ^{Note 2)}
D-M9□ D-M9□W	2 (Different surfaces, Same surface) 1	15	80	85	90	95	
	n	$15 + 40 \frac{(n-2)}{2}$ (n = 2, 4, 6, 8 ...) ^{Note 1)}	$80 + 40 \frac{(n-4)}{2}$ (n = 4, 8, 12, 16 ...) ^{Note 2)}	$85 + 40 \frac{(n-4)}{2}$ (n = 4, 8, 12, 16 ...) ^{Note 2)}	$90 + 40 \frac{(n-4)}{2}$ (n = 4, 8, 12, 16 ...) ^{Note 2)}	$95 + 40 \frac{(n-4)}{2}$ (n = 4, 8, 12, 16 ...) ^{Note 2)}	
D-M9□V D-M9□WV	2 (Different surfaces, Same surface) 1	10	55	60	65	70	
	n	$10 + 30 \frac{(n-2)}{2}$ (n = 2, 4, 6, 8 ...) ^{Note 1)}	$55 + 30 \frac{(n-4)}{2}$ (n = 4, 8, 12, 16 ...) ^{Note 2)}	$60 + 30 \frac{(n-4)}{2}$ (n = 4, 8, 12, 16 ...) ^{Note 2)}	$65 + 30 \frac{(n-4)}{2}$ (n = 4, 8, 12, 16 ...) ^{Note 2)}	$70 + 30 \frac{(n-4)}{2}$ (n = 4, 8, 12, 16 ...) ^{Note 2)}	
D-M9□A	2 (Different surfaces, Same surface) 1	15	80	85	95	100	
	n	$15 + 40 \frac{(n-2)}{2}$ (n = 2, 4, 6, 8 ...) ^{Note 1)}	$80 + 40 \frac{(n-4)}{2}$ (n = 4, 8, 12, 16 ...) ^{Note 2)}	$85 + 40 \frac{(n-4)}{2}$ (n = 4, 8, 12, 16 ...) ^{Note 2)}	$95 + 40 \frac{(n-4)}{2}$ (n = 4, 8, 12, 16 ...) ^{Note 2)}	$100 + 40 \frac{(n-4)}{2}$ (n = 4, 8, 12, 16 ...) ^{Note 2)}	
D-M9□AV	2 (Different surfaces, Same surface) 1	10	60	65	70	75	
	n	$10 + 30 \frac{(n-2)}{2}$ (n = 2, 4, 6, 8 ...) ^{Note 1)}	$60 + 30 \frac{(n-4)}{2}$ (n = 4, 8, 12, 16 ...) ^{Note 2)}	$65 + 30 \frac{(n-4)}{2}$ (n = 4, 8, 12, 16 ...) ^{Note 2)}	$70 + 30 \frac{(n-4)}{2}$ (n = 4, 8, 12, 16 ...) ^{Note 2)}	$75 + 30 \frac{(n-4)}{2}$ (n = 4, 8, 12, 16 ...) ^{Note 2)}	
D-A5□/A6 D-F5□/J59 D-F5□W/J59W D-F5BA/F59F	2 (Different surfaces, Same surface) 1	15	90	100	110	120	
	n (Same surface)	$15 + 55 \frac{(n-2)}{2}$ (n = 2, 4, 6, 8 ...) ^{Note 1)}	$90 + 55 \frac{(n-4)}{2}$ (n = 4, 8, 12, 16 ...) ^{Note 2)}	$100 + 55 \frac{(n-4)}{2}$ (n = 4, 8, 12, 16 ...) ^{Note 2)}	$110 + 55 \frac{(n-4)}{2}$ (n = 4, 8, 12, 16 ...) ^{Note 2)}	$120 + 55 \frac{(n-4)}{2}$ (n = 4, 8, 12, 16 ...) ^{Note 2)}	
D-A59W	2 (Different surfaces, Same surface)	20	90	100	110	120	
	n (Same surface)	$20 + 55 \frac{(n-2)}{2}$ (n = 2, 4, 6, 8 ...) ^{Note 1)}	$90 + 55 \frac{(n-4)}{2}$ (n = 4, 8, 12, 16 ...) ^{Note 2)}	$100 + 55 \frac{(n-4)}{2}$ (n = 4, 8, 12, 16 ...) ^{Note 2)}	$110 + 55 \frac{(n-4)}{2}$ (n = 4, 8, 12, 16 ...) ^{Note 2)}	$120 + 55 \frac{(n-4)}{2}$ (n = 4, 8, 12, 16 ...) ^{Note 2)}	
	1	15	90	100	110	120	
D-F5NT	2 (Different surfaces, Same surface) 1	25	110	120	130	140	
	n (Same surface)	$25 + 55 \frac{(n-2)}{2}$ (n = 2, 4, 6, 8 ...) ^{Note 1)}	$110 + 55 \frac{(n-4)}{2}$ (n = 4, 8, 12, 16 ...) ^{Note 2)}	$120 + 55 \frac{(n-4)}{2}$ (n = 4, 8, 12, 16 ...) ^{Note 2)}	$130 + 55 \frac{(n-4)}{2}$ (n = 4, 8, 12, 16 ...) ^{Note 2)}	$140 + 55 \frac{(n-4)}{2}$ (n = 4, 8, 12, 16 ...) ^{Note 2)}	
D-B5□/B64 D-G5□/K59 D-G5□W D-K59W D-G5BA D-G59F D-G5NT	2 (Different surfaces)	15	90	100	110		
	(Same surface)	75					
	n	(Different surfaces)	$15 + 50 \frac{(n-2)}{2}$ (n = 2, 4, 6, 8, ...) ^{Note 1)}	$90 + 50 \frac{(n-4)}{2}$ (n = 4, 8, 12, 16, ...) ^{Note 2)}	$100 + 50 \frac{(n-4)}{2}$ (n = 4, 8, 12, 16, ...) ^{Note 2)}	$110 + 50 \frac{(n-4)}{2}$ (n = 4, 8, 12, 16, ...) ^{Note 2)}	
		(Same surface)	$75 + 50(n-2)$ (n = 2, 3, 4, ...)	$90 + 50(n-2)$ (n = 2, 4, 6, 8, ...) ^{Note 1)}	$100 + 50(n-2)$ (n = 2, 4, 6, 8, ...) ^{Note 1)}	$110 + 50(n-2)$ (n = 2, 4, 6, 8, ...) ^{Note 1)}	
		1	10	90	100	110	
D-B59W	2 (Different surfaces)	20	90	100	110		
	(Same surface)	75					
	n	(Different surfaces)	$20 + 50 \frac{(n-2)}{2}$ (n = 2, 4, 6, 8, ...) ^{Note 1)}	$90 + 50 \frac{(n-4)}{2}$ (n = 4, 8, 12, 16, ...) ^{Note 2)}	$100 + 50 \frac{(n-4)}{2}$ (n = 4, 8, 12, 16, ...) ^{Note 2)}	$110 + 50 \frac{(n-4)}{2}$ (n = 4, 8, 12, 16, ...) ^{Note 2)}	
		(Same surface)	$75 + 50(n-2)$ (n = 2, 3, 4, ...)	$90 + 50(n-2)$ (n = 2, 4, 6, 8, ...) ^{Note 1)}	$100 + 50(n-2)$ (n = 2, 4, 6, 8, ...) ^{Note 1)}	$110 + 50(n-2)$ (n = 2, 4, 6, 8, ...) ^{Note 1)}	
		1	15	90	100	110	

Note 1) When "n" is an odd number, an even number that is one larger than this odd number is used for the calculation.

Note 2) When "n" is an odd number, a multiple of 4 that is larger than this odd number is used for the calculation.

Minimum Auto Switch Mounting Stroke

n: No. of auto switches (mm)

Auto switch model	No. of auto switch mounted	Mounting brackets other than center trunnion	Center trunnion				
			ø40	ø50	ø63	ø80	ø100
D-A3□ D-G39 D-K39	2	(Different surfaces)	35	75	80	90	
		(Same surface)	100	100	100	100	
	n	(Different surfaces)	$35 + 30(n-2)$ (n = 2, 3, 4, ...)	$75 + 30(n-2)$ (n = 2, 4, 6, 8, ...) Note 1)	$80 + 30(n-2)$ (n = 2, 4, 6, 8, ...) Note 1)	$90 + 30(n-2)$ (n = 2, 4, 6, 8, ...) Note 1)	
		(Same surface)	$100 + 100(n-2)$ (n = 2, 3, 4, ...)	$100 + 100(n-2)$ (n = 2, 4, 6, 8, ...) Note 1)			
	1	10	75	80	90		
D-A44	2	(Different surfaces)	35	75	80	90	
		(Same surface)	55				
	n	(Different surfaces)	$35 + 30(n-2)$ (n = 2, 3, 4, ...)	$75 + 30(n-2)$ (n = 2, 4, 6, 8, ...) Note 1)	$80 + 30(n-2)$ (n = 2, 4, 6, 8, ...) Note 1)	$90 + 30(n-2)$ (n = 2, 4, 6, 8, ...) Note 1)	
		(Same surface)	$55 + 50(n-2)$ (n = 2, 3, 4, ...)	$75 + 50(n-2)$ (n = 2, 4, 6, 8, ...) Note 1)	$80 + 50(n-2)$ (n = 2, 4, 6, 8, ...) Note 1)	$90 + 50(n-2)$ (n = 2, 4, 6, 8, ...) Note 1)	
	1	10	75	80	90		
D-A3□C D-G39C D-K39C	2	(Different surfaces)	20	75	80	90	
		(Same surface)	100	100	100	100	
	n	(Different surfaces)	$20 + 35(n-2)$ (n = 2, 3, 4, ...)	$75 + 35(n-2)$ (n = 2, 4, 6, 8, ...) Note 1)	$80 + 35(n-2)$ (n = 2, 4, 6, 8, ...) Note 1)	$90 + 35(n-2)$ (n = 2, 4, 6, 8, ...) Note 1)	
		(Same surface)	$100 + 100(n-2)$ (n = 2, 3, 4, 5-...)	$100 + 100(n-2)$ (n = 2, 4, 6, 8, ...) Note 1)			
	1	10	75	80	90		
D-A44C	2	(Different surfaces)	20	75	80	90	
		(Same surface)	55	75	80	90	
	n	(Different surfaces)	$20 + 35(n-2)$ (n = 2, 3, 4, ...)	$75 + 35(n-2)$ (n = 2, 4, 6, 8, ...) Note 1)	$80 + 35(n-2)$ (n = 2, 4, 6, 8, ...) Note 1)	$90 + 35(n-2)$ (n = 2, 4, 6, 8, ...) Note 1)	
		(Same surface)	$55 + 50(n-2)$ (n = 2, 3, 4, ...)	$75 + 50(n-2)$ (n = 2, 4, 6, 8, ...) Note 1)	$80 + 50(n-2)$ (n = 2, 4, 6, 8, ...) Note 1)	$90 + 50(n-2)$ (n = 2, 4, 6, 8, ...) Note 1)	
	1	10	75	80	90		
D-Z7□/Z80 D-Y59□/Y7P D-Y7□W	2 (Different surfaces, Same surface) 1	15	80	85	90	95	105
	n	$15 + 40 \frac{(n-2)}{2}$ (n = 2, 4, 6, 8-...) Note 1)	$80 + 40 \frac{(n-4)}{2}$ (n = 4, 8, 12, 16-...) Note 2)	$85 + 40 \frac{(n-4)}{2}$ (n = 4, 8, 12, 16-...) Note 2)	$90 + 40 \frac{(n-4)}{2}$ (n = 4, 8, 12, 16-...) Note 2)	$95 + 40 \frac{(n-4)}{2}$ (n = 4, 8, 12, 16-...) Note 2)	$105 + 40 \frac{(n-4)}{2}$ (n = 4, 8, 12, 16-...) Note 2)
D-Y69□/Y7PV D-Y7□WV	2 (Different surfaces, Same surface) 1	10	65	75	80	90	
	n	$10 + 30 \frac{(n-2)}{2}$ (n = 2, 4, 6, 8-...) Note 1)	$65 + 30 \frac{(n-4)}{2}$ (n = 4, 8, 12, 16-...) Note 2)	$75 + 30 \frac{(n-4)}{2}$ (n = 4, 8, 12, 16-...) Note 2)	$80 + 30 \frac{(n-4)}{2}$ (n = 4, 8, 12, 16-...) Note 2)	$90 + 30 \frac{(n-4)}{2}$ (n = 4, 8, 12, 16-...) Note 2)	
D-Y7BA	2 (Different surfaces, Same surface) 1	20	95	100	105	110	
	n	$20 + 45 \frac{(n-2)}{2}$ (n = 2, 4, 6, 8-...) Note 1)	$95 + 45 \frac{(n-4)}{2}$ (n = 4, 8, 12, 16-...) Note 2)	$100 + 45 \frac{(n-4)}{2}$ (n = 4, 8, 12, 16-...) Note 2)	$105 + 45 \frac{(n-4)}{2}$ (n = 4, 8, 12, 16-...) Note 2)	$110 + 45 \frac{(n-4)}{2}$ (n = 4, 8, 12, 16-...) Note 2)	

Note 1) When "n" is an odd number, an even number that is one larger than this odd number is used for the calculation.

Note 2) When "n" is an odd number, a multiple of 4 that is larger than this odd number is used for the calculation.

CEP1
CE1
CE2
ML2B

D-□
-X□

Operating Range

Auto switch model	Bore size (mm)				
	40	50	63	80	100
D-A9□/A9□V	7	—	9	9	9
D-M9□/M9□V D-M9□W/M9□WV D-M9□A/M9□AV	5	5	5.5	6	6.5
D-Z7□/Z80	8	7	9	9.5	10.5
D-A3□/A44 D-A3□C/A44C	9	10	11	11	11
D-A5□/A6□ D-B5□/B64					
D-A59W	13	13	14	14	15
D-B59W	14	14	17	16	18

Auto switch model	Bore size (mm)				
	40	50	63	80	100
D-Y59□/Y69□ D-Y7P/Y7□V D-Y7□W/Y7□WV D-Y7BA	8	7	5.5	6.5	6.5
D-F5□/J59/F5□W D-J59W/F5BA D-F5NT D-F59F	4	4	4.5	4.5	4.5
D-G5□/K59/G5□W D-K59W/G5BA D-G5NT/G59F	5	6	6.5	6.5	7
D-G39/K39 D-G39C/K39C	9	9	10	10	11

* D-A9□ and D-A9□V cannot be mounted on ø50.

* Since the operating range is provided as a guideline including hysteresis, it cannot be guaranteed (assuming approximately ±30% dispersion). It may vary substantially depending on an ambient environment.

Auto Switch Mounting Bracket: Part No.

<Tie-rod mounting>

Auto switch model	Bore size (mm)				
	40	50	63	80	100
D-A9□/A9□V D-M9□/M9□V D-M9□W/M9□WV D-M9□A/M9□AV	BA7-040	BA7-040	BA7-063	BA7-080	BA7-080
D-A5□/A6□ D-A59W D-F5□/J59 D-F5□W/J59W D-F59F/F5NT	BT-04	BT-04	BT-06	BT-08	BT-08
D-A3□C/A44C D-G39C/K39C	BA3-040	BA3-050	BA3-063	BA3-080	BA3-100
D-Z7□/Z80 D-Y59□/Y69□ D-Y7P/Y7PV D-Y7□W/Y7□WV D-Y7BA	BA4-040	BA4-040	BA4-063	BA4-080	BA4-080

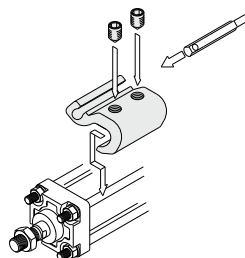

• Mounting example of D-A9□(V)/M9□(V)/M9□W(V)/M9□A(V)

<Band mounting>

Auto switch model	Bore size (mm)				
	40	50	63	80	100
D-A3□/A44 D-G39/K39	BD1-04M	BD1-05M	BD1-06M	BD1-08M	BD1-10M
D-B5□/B64 D-B59W D-G5□/K59 D-G5□W/K59W D-G59F D-G5NT	BA-04	BA-05	BA-06	BA-08	BA-10

Note 1) D-A9□ and D-A9□V cannot be mounted on ø50.

Note 2) Auto switch mounting brackets are included in D-A3□C/A44C/G39C/K39C.

Order them in accordance with the cylinder size as shown below.

(Example) ø40: D-A3□C-4, ø50: D-A3□C-5

ø63: D-A3□C-6, ø80: D-A3□C-8, ø100: D-A3□C-10

Order them with the part numbers above when the mounting brackets are required separately.

[Mounting screw set made of stainless steel]

The following set of mounting screws made of stainless steel (including nuts) is available. Use it in accordance with the operating environment.

(Please order the auto switch mounting bracket and band separately, since they are not included.)

BBA1: For D-A5/A6/F5/J5 types

BBA3: For D-B5/B6/G5/K5 types

D-F5BA/G5BA auto switches are set on the cylinder with the stainless steel screws above when shipped. When an auto switch is shipped independently, BBA1 or BBA3 is attached.

Note 3) Refer to pages 1047 and 1055 for the details of BBA1 and BBA3.

Note 4) When using M9□A(V)/Y7BA, do not use the steel set screws which is included with the auto switch mounting brackets above (BA7-□□□, BA4-□□□).

Order a stainless steel screw set (BBA1) separately, and select and use the M4 x 6L stainless steel set screws included in the BBA1.

Besides the models listed in How to Order, the following auto switches are applicable.
Refer to pages 941 to 1067 for detailed specifications.

Auto switch type	Part no.	Electrical entry (Fetching direction)	Features
Reed	D-A93V, A96V	Grommet (Perpendicular)	—
	D-A90V		Without indicator light
	D-A53, A56, B53, Z73, Z76	Grommet (In-line)	—
	D-A67, Z80		Without indicator light
Solid state	D-M9NV, M9PV, M9BV	Grommet (Perpendicular)	—
	D-Y69A, Y69B, Y7PV		Diagnostic indication (2-color indicator)
	D-M9NWV, M9PWV, M9BWW		
	D-Y7NWV, Y7PWV, Y7BWW	Grommet (In-line)	Water resistant (2-color indicator)
	D-M9NAV, M9PAV, M9BAV		—
	D-Y59A, Y59B, Y7P		Diagnostic indication (2-color indicator)
	D-F59, F5P, J59		
	D-Y7NW, Y7PW, Y7BW		Water resistant (2-color indicator)
	D-F59W, F5PW, J59W		
	D-F5BA, Y7BA		
	D-F5NT, G5NT		

- * For solid state auto switches, auto switches with a pre-wired connector are also available. Refer to pages 1014 and 1015 for details.
- * Normally closed (NC = b contact) solid state auto switches (D-F9G/F9H/Y7G/Y7H types) are also available. Refer to pages 959 and 961 for details.
- * Wide range detection type, solid state auto switches (D-G5NB type) are also available. Refer to page 1004 for details.

CEP1
CE1
CE2
ML2B

D-□
-X□

CEU2 Controller

Controller CEU2/Specifications

Model	CEU2	CEU2P
Type	Controller	
Mounting	Surface mounting (DIN rail or screw stop)	
Operation mode	PRESET mode, PROGRAM mode, RUN mode	
Display system	LCD (with back light)	
No. of digits	Program 1 to 16, Step 1 to 32	
Position control system	P.T.P control (point to point)	
No. of control shaft	1 axis	
Positioning system	Key input (on front face)	
Positioning range	9999.9 mm	
Min. setting range	0.1 mm	
Memory system	Static RAM 8 K bite (Battery back up: life 5 years)	
Min. interval	5 mm or more	
Input signal	<ul style="list-style-type: none"> ● Start ● Hold ● Automatic/Manual ● Return to origin ● Emergency stop ● Manual: extended, retracted (2 bit) ● Program selection (4 bit) ● Input origin ● Reset 	
Output signal	<ul style="list-style-type: none"> ● Completion of positioning signal ● Program END signal ● Completion to figure out origin signal ● Abnormal signal 	
Control output	NPN open collector (30 VDC, 50 mA)	PNP open collector (30 VDC, 50 mA)
Counting speed	20 kHz (Kcps)	
Power supply	90 to 110 VAC, 50/60 Hz and 21.6 to 26.4 VDC, 0.4 A	
Operating temperature range	0 to 50°C (No freezing)	
Humidity range	25 to 85% (No condensation)	
Shock resistance	Endurance 10 to 55 Hz, Amplitude 0.75 mm, X, Y, Z for 2 hours each	
Noise resistance	Square wave noise from a noise simulator (Pulse duration 1 μs) Between 100 VAC line ±1500 V, I/O line ±600 V	
Impact resistance	Endurance 10 G; X, Y, Z directions, 3 times each	
Withstand voltage	Between case and AC line: 1500 VAC for 1 min. (3 mA or less) Between case and 12 VDC line: 500 VAC for 1 min. (3 mA or less)	
Power consumption	100 VA or less	
Insulation resistance	Between case and AC line: 50 MΩ or more (500 VDC measured via megohmmeter)	
Weight	690 g	

* Refer to operation manual of CEU2 regarding detailed positioning system.

Dimensions

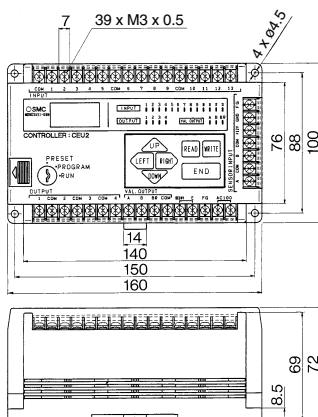

As for multi counter, it will be common to CEP1 and CE1 series. For details, refer to Multi counter/CEU5 on page 667 respectively.

Wiring with External Equipment

<Wiring with controller CEU2>

1. Wiring of driving power of controller

To operate the controller, use a power supply with the following specifications: 90 to 110 VAC, 50/60 Hz, and 21.6 to 26.4 VDC, 0.4 A or higher.

3. Output circuit

There are two outputs, the NPN open collector and the PNP open collector. The maximum rating is 30 VDC, 50 mA. Operating the controller by exceeding this voltage and amperage could damage the electric circuit. Therefore, the equipment to be connected must be below this rating.

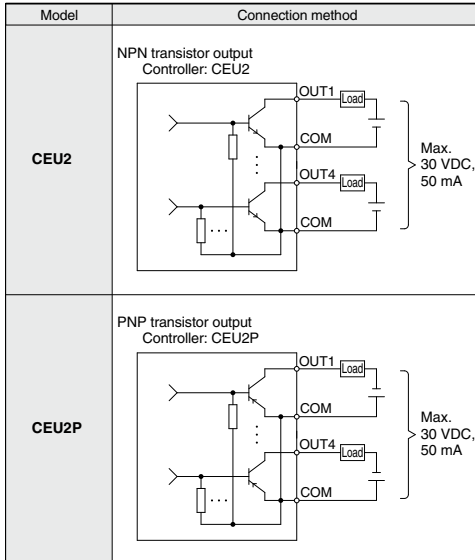

* However, on the valve output side, the COM of the input circuit and the COM of the output circuit are electrically insulated from each other.

2. Input circuit

The voltage and the amperage capacity of the switch or the PLC to be connected are 24 VDC, 10 mA or higher.

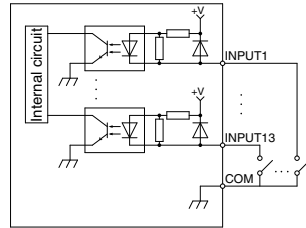

4. Valve output circuit

The maximum rating is 24 VDC, 80 mA. Operating the controller by exceeding this voltage and amperage could damage the electric circuit. Therefore, the equipment to be connected must be below this rating.

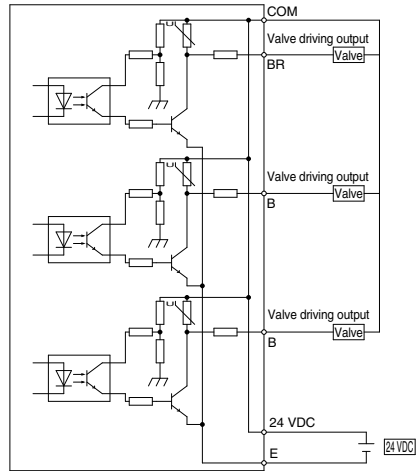

Electrical Wiring

<Output system of positioning detection sensor>

The position detection sensor of the stroke reading cylinder outputs an A/B phase difference (open collector output) as shown in the diagram below.

The relation between the moving distance and the output signal of the stroke reading cylinder with brake is as follows: Every 0.1 mm of movement of the stroke reading cylinder with brake outputs 1 pulse signal to both output terminals A and B.

The maximum response speed of the sensor for the stroke reading cylinder with brake is at a maximum cylinder speed of 1500 mm/s (15 kcps).

The relationship between the displacement of the stroke reading cylinder with brake and the output pulse

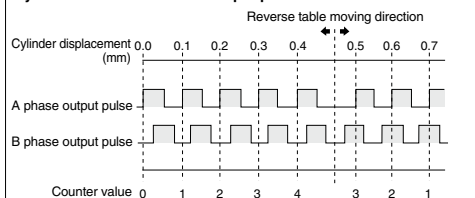

<Input, Output>

The connection of the input/output signals of the position detection sensor of the stroke reading cylinder is effected through the connector that extends from the cylinder. The output circuit and the connection of the connectors are described in the diagram below.

Output circuit of stroke reading cylinder with brake

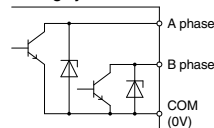

Connector pin arrangement

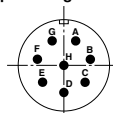

Signal

Contact signal	Wire color	Signal name
A	White	A phase
B	Yellow	B phase
C	Brown	COM (0 V)
D	Blue	COM (0 V)
E	Red	+12 V to 24 V
F	Black	0 V
G	—	Shield

CEP1

CE1

CE2

ML2B

D-□

-X□