

ISO Standard Hydraulic Cylinder

CHSD/CHSG Series

CHQ

CHK

CHN

CHM

CHS

CH2

CHA

Related
Products

D-

CHSD Series

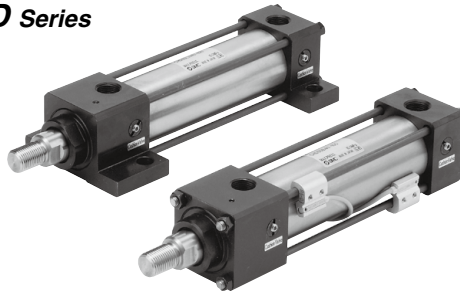

Nominal pressure: **10 MPa**

Bore size (mm): 40, 50, 63, 80, 100

CHSG Series



Nominal pressure: **16 MPa**

Bore size (mm): 32, 40, 50, 63, 80, 100

ISO Standard

Hydraulic Cylinder

CHS Series

Nominal pressure 10 MPa/16 MPa

Reduced projection area: **76%** or less

Reduced overall length

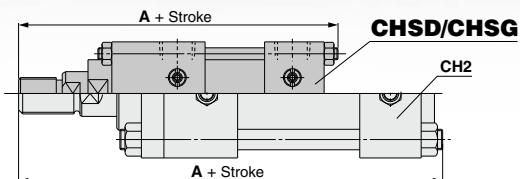
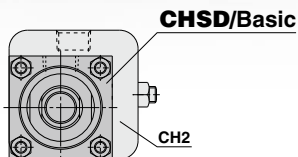

- **Maximum weight: no more than 50%* or 52%* of CH2 series (CHSD) (CHSG)**

* Compared to CH2 series, the tie-rod type cylinder of same size.

- **Cylinder with built-in cover and mounting bracket allows easy disassembly and assembly.**

Tube size (mm)	Overall length (A size)		
	CHSD	CHSG	CH2
32	—	153	207
40	163	184	212
50	177	200	231
63	199	217	257
80	225	251	295
100	260	275	325



Conforming to ISO 10762 (JIS B 8367-5:2002)

CHSD Series/10 MPa

Ø40, Ø50, Ø63, Ø80, Ø100



Conforming to ISO 6020-2 (JIS B 8367-2:2002)

CHSG Series/16 MPa

Ø32, Ø40, Ø50, Ø63, Ø80, Ø100

ISO Standard Hydraulic Cylinder

CHSD Series

10 MPa

∅40, ∅50, ∅63, ∅80, ∅100

How to Order

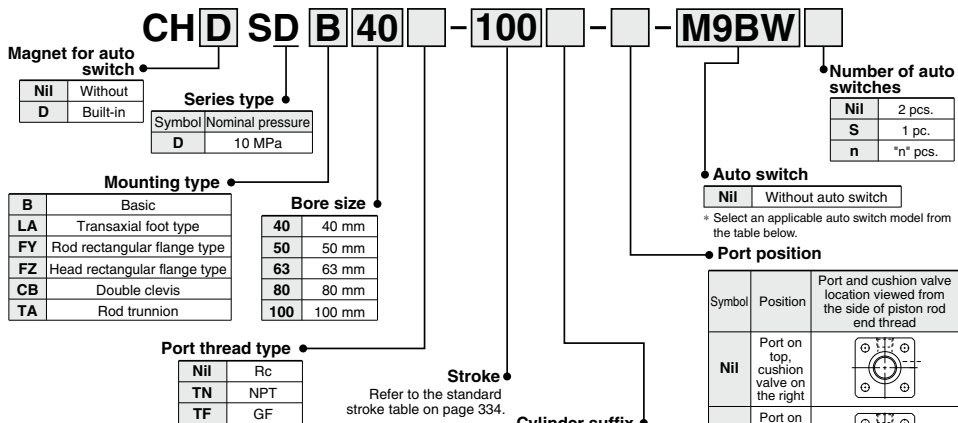

Built-in Magnet Cylinder Model

If a built-in magnet cylinder without auto switch is required, there is no need to enter the symbol for the auto switch. (Example) CHDSDB50-100

Applicable Auto Switches/Refer to pages 431 to 490 for further details on each auto switch.

Type	Special function	Electrical entry	Indicator light	Wiring (output)	Load voltage		Auto switch model	Lead wire length (m)				Pre-wired connector	Applicable load
					DC	AC		0.5 (Nil)	1 (M)	3 (L)	5 (Z)		
Solid state auto switch	Diagnostic indication (2-color indicator)	Grommet	Yes	3-wire (NPN)	24 V	5 V, 12 V	M9N	●	●	●	○	○	IC circuit
				3-wire (PNP)		12 V	M9P	●	●	●	○	○	—
				2-wire	24 V	5 V, 12 V	M9NW	●	●	●	○	○	IC circuit
				3-wire (PNP)		12 V	M9PW	●	●	●	○	○	—
	Water resistant (2-color indicator)	Grommet	No	3-wire (NPN)	24 V	5 V, 12 V	M9BW	●	●	●	○	○	IC circuit
				2-wire		12 V	M9BA**	○	○	●	○	○	IC circuit
				3-wire (PNP)	24 V	5 V, 12 V	M9BA**	○	○	●	○	○	—
				3-wire (PNP)		12 V	M9BA**	○	○	●	○	○	—
Diagnostic output (2-color indicator)	Grommet	No	4-wire (NPN)	24 V	5 V, 12 V	F59F	●	●	●	○	○	IC circuit	
			2-wire	—	—	Z76	●	●	●	○	○	IC circuit	
Reed auto switch	Diagnostic output (2-color indicator)	Grommet	Yes	3-wire (NPN equiv.)	24 V	5 V	Z76	●	●	●	○	○	IC circuit
						100 V	Z73	●	●	●	○	○	—
				No	2-wire	100 V or less	Z80	●	●	●	○	○	IC circuit
						100 V, 200 V	A54*	●	●	●	○	○	—
No	2-wire	200 V or less	A64*	●	●	●	○	○	—				
		Yes	—	—	A59W*	●	●	●	○	○	IC circuit		

** Water resistant type auto switches can be mounted on the above models, but in such case SMC cannot guarantee water resistance. Consult with SMC regarding water resistant types with the above model numbers.

* Lead wire length symbols: 0.5 m Nil (Example) M9NW
 1 m M (Example) M9NWM
 3 m L (Example) M9NWL
 5 m Z (Example) M9NWZ

* Solid state auto switches marked with "○" are produced upon receipt of order.
 * D-A5□/A6□/A59W can not be mounted to ∅40, 50.

* Besides the models in the above table, there are some other auto switches that are applicable. For more information, refer to page 340.

* For details about auto switches with pre-wired connector, refer to pages 474 and 475.

* D-M9□, M9□W, M9□A, Z7□, Z80 auto switches are shipped together, (not assembled). (Only auto switch mounting brackets are packed assembled.)

Symbol	Position	Port and cushion valve location viewed from the side of piston rod end thread
Nil	Port on top, cushion valve on the right	
A	Port on top, cushion valve on the left	
B	Port on top, cushion valve down	
C	Port on the right, cushion valve down	
D	Port on the right, cushion valve on top	
E	Port on the right, cushion valve on the left	

⇄ Piping port | Cushion valve

Note 1) Refer to table 1 for manufacturability.

Note 2) Diagrams illustrate the view from the rod on the left side of the cylinder dimensions.

Note 3) For mounting types FY, FZ, or TA, indicate port position with the symbol B.

Table 1 Manufacturability Check List by Mounting Type and Port Position

Port position	Mounting bracket	B	LA	FY FZ	CB	TA
Nil	○	○	○	○	○	○
A	○	○	○	○	○	—
B	○	○	○	○	○	○
C	○	—	○	○	○	○
D	○	—	○	○	○	—
E	○	—	○	○	○	—

○: Standard product ○: Made to Order

—: Not available due to size limitation.

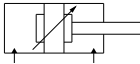

Specifications

Bore size (mm)		40	50	63	80	100
Action		Double Acting: Single Rod				
Fluid		General mineral hydraulic fluid				
Nominal pressure		10 MPa				
Maximum allowable pressure		12 MPa				
Proof pressure		15 MPa				
Minimum operating pressure	With pressure at front side	0.25 MPa				
	With pressure at rear side	0.15 MPa				
Ambient and fluid temperature	Without magnet	-10 to 80°C				
	Built-in magnet	-10 to 60°C				
Piston speed		8 to 300 mm/s				
Cushion		Cushion seal				
Thread tolerance		JIS 6 g/6 H				
Stroke length tolerance		From 100st ₀ ^{+0.8} , 101 to 250st ₀ ^{+1.0} , 251 to 630st ₀ ^{+1.25} , 631 to 1000st ₀ ^{+1.4}				

Note) Refer to page 214 for definitions of terms related to pressure.

Standard Stroke

Bore size (mm)	Standard stroke (mm)
40	25 to 800
50	25 to 800
63	25 to 800
80	25 to 800
100	25 to 1000

Theoretical Output

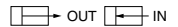

Unit: N

Bore size (mm)	Rod size (mm)	Operating direction	Piston area (mm ²)	Operating pressure (MPa)		
				3.5	7	10
40	22	OUT	1256	4396	8792	12560
		IN	876	3066	6132	8760
50	28	OUT	1963	6871	13741	19630
		IN	1347	4715	9429	13470
63	36	OUT	3117	10910	21819	31170
		IN	2099	7346	14693	20990
80	45	OUT	5026	17591	35182	50260
		IN	3436	12026	24052	34360
100	56	OUT	7853	27486	54971	78530
		IN	5390	18865	37730	53900

Theoretical output (N) = Pressure (MPa) x Piston area (mm²)

Weight

Unit: kg

Bore size (mm)			40	50	63	80	100
Basic weight (0 stroke)	Basic	B	2.10	3.20	5.10	8.90	14.5
	Transaxial foot	LA	2.40	3.60	5.50	9.70	16.0
	Rod flange	FY	2.60	3.80	5.90	10.1	16.0
	Head flange	FZ	2.50	3.80	6.00	10.0	16.4
	Double clevis	CB	2.30	3.50	6.10	9.90	16.2
	Rod trunnion	TA	2.10	3.40	5.40	9.40	15.5
Additional weight per 10 strokes			0.06	0.09	0.13	0.21	0.32

Construction

CH□SDB

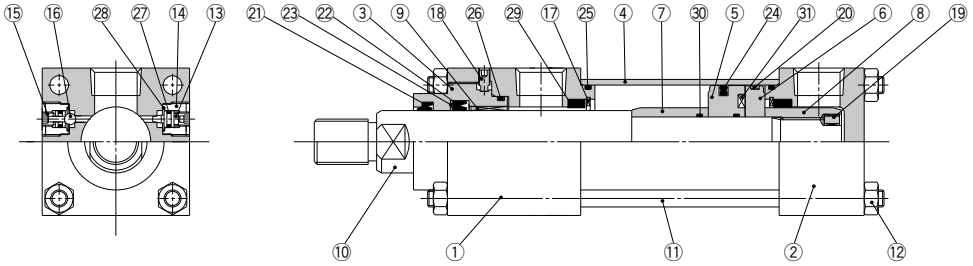

CHQ

CHK□

CHN

CHM

CHS□

CH2□

CHA

Related Products

D-□

Parts List

No.	Description	Material
1	Rod cover	Carbon steel
2	Head cover	Carbon steel
3	Seal holder	Carbon steel
4	Cylinder tube	Stainless steel
5	Piston	Stainless steel
6	Magnet plate	Stainless steel
7	Cushion ring	Carbon steel
8	Cushion ring nut	Carbon steel
9	Bushing	Copper alloy
10	Piston rod	Carbon steel
11	Tie-rod	Chromium molybdenum steel
12	Tie-rod nut	Carbon steel
13	Cushion valve	Alloy steel
14	Valve holder	Carbon steel
15	Air release valve	Alloy steel
16	Check ball	Bearing steel

No.	Description	Material
17	Retaining ring	Carbon tool steel
18	Set screw	Alloy steel
19	Pin	Stainless steel
20	Wear ring	Resin
21	Scraper	NBR
22	Rod seal	NBR
23	Back-up ring	Resin
24	Piston seal	NBR
25	Cylinder tube gasket	NBR
26	Holder gasket	NBR
27	Valve seal	NBR
28	Valve holder gasket	NBR
29	Cushion seal	—
30	Piston gasket	NBR
31	Magnet	—

Replacement Parts: Seal Kit

Bore size (mm)	Seal kit no.
40	CHSD40-PS
50	CHSD50-PS
63	CHSD63-PS
80	CHSD80-PS
100	CHSD100-PS

* Seal kit consists of items 21 to 28 and 29, and can be ordered by using the seal kit number for each bore size.

CHSD Series

Dimensions

Basic: CHSDB

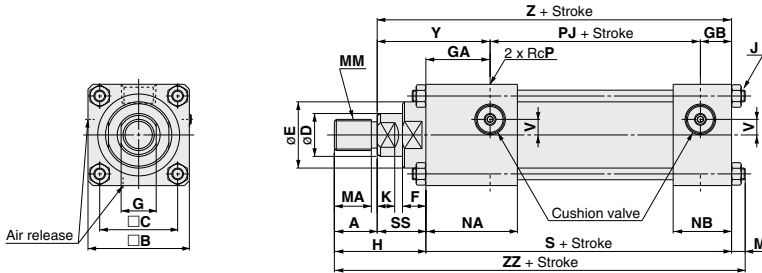

Bore size (mm)	Stroke range	A	B	C	D	E	F	G	GA	GB	H	J	K	M	MA	MM	NA	NB	P	PJ	S	SS	V	Y	Z	ZZ
40	25 to 800	22	52	40	22	34	12	19	33	16	47	M6 x 1	8	7.5	19	M16 x 1.5	46	29	3/8	58	107	25	6.5	58	132	161.5
50	25 to 800	28	65	50	28	42	15	24	34	16	59	M8 x 1	11	9	25	M20 x 1.5	46.5	28.5	3/8	58	108	31	8	65	139	176
63	25 to 800	36	77	58	36	50	19	30	31	18	74	M8 x 1	13	9	32	M27 x 2	46	33	1/2	66	115	38	12	69	153	198
80	25 to 800	45	96	75	45	60	13	41	42	17	80	M10 x 1.25	17	10.5	41	M33 x 2	57	32	1/2	74	133	35	15	77	168	223.5
100	25 to 1000	56	115	90	56	72	16	50	38	22	97	M14 x 1.5	19	14.5	52	M42 x 2	58	42	3/4	86	146	41	15	79	187	257.5

Transaxial foot: CHSDLA

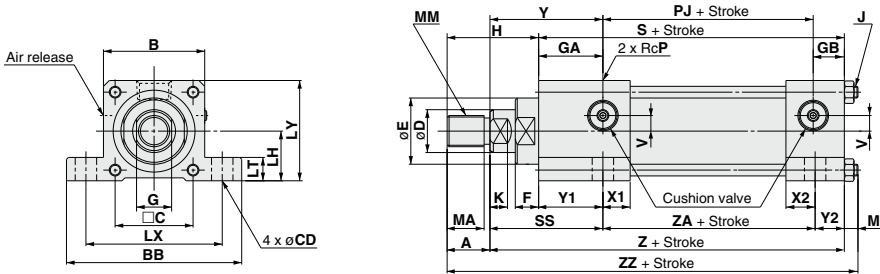

Bore size (mm)	Stroke range	A	B	BB	C	CD	D	E	F	G	GA	GB	H	J	K	LH	LT	LX	LY	M	MA	MM	P	PJ	S	SS
40	25 to 800	22	52	90	40	11	22	34	12	19	33	16	47	M6 x 1	8	25.5	12	70	51.5	7.5	19	M16 x 1.5	3/8	58	107	58
50	25 to 800	28	65	103	50	11	28	42	15	24	34	16	59	M8 x 1	11	32	12	83	64.5	9	25	M20 x 1.5	3/8	58	108	65
63	25 to 800	36	77	115	58	11	36	50	19	30	31	18	74	M8 x 1	13	38	12	95	76.5	9	32	M27 x 2	1/2	66	115	68
80	25 to 800	45	96	147	75	14	45	60	13	41	42	17	80	M10 x 1.25	17	47.5	18	121	95.5	10.5	41	M33 x 2	1/2	74	133	77
100	25 to 1000	56	115	179	90	18	56	72	16	50	38	22	97	M14 x 1.5	19	57	25	145	114.5	14.5	52	M42 x 2	3/4	86	146	79

Bore size (mm)	V	X1	X2	Y	Y1	Y2	ZA	Z	ZZ
40	6.5	13	14	58	33	15	59	132	161.5
50	8	12.5	13.5	65	34	15	59	139	176
63	12	16	16	69	30	17	68	153	198
80	15	15	15	77	42	17	74	168	223.5
100	15	20	20	79	38	22	86	187	257.5

Rod flange: CHSDFY

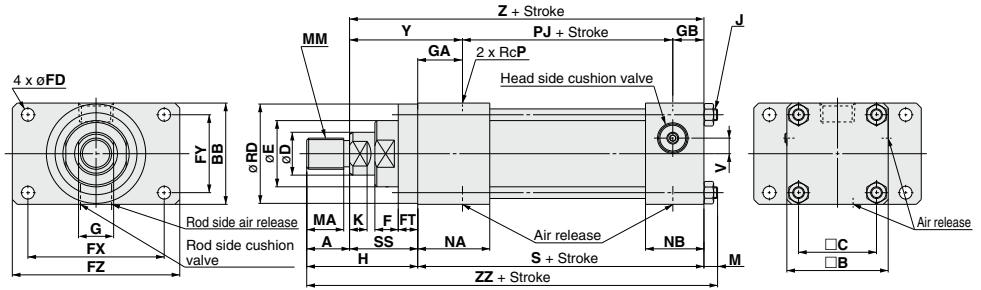

Bore size (mm)	Stroke range	A	B	BB	C	D	E	F	FD	FT	FX	FY	FZ	G	GA	GB	H	J	K	M	MA	MM	NA	NB	P	PJ
40	25 to 800	22	52	52	40	22	34	12	6.6	10	70	40	86	19	23	16	57	M6 x 1	8	7.5	19	M16 x 1.5	36	29	3/8	58
50	25 to 800	28	65	65	50	28	42	15	9	10	86	50	105	24	24	16	69	M8 x 1	11	9	25	M20 x 1.5	36.5	28.5	3/8	58
63	25 to 800	36	77	77	58	36	50	19	9	10	98	56	118	30	21	18	84	M8 x 1	13	9	32	M27 x 2	36	33	1/2	66
80	25 to 800	45	96	96	75	45	60	13	11	16	119	70	143	41	26	17	96	M10 x 1.25	17	10.5	41	M33 x 2	41	32	1/2	74
100	25 to 1000	56	115	115	90	56	72	16	13.5	16	138	90	162	50	22	22	113	M14 x 1.5	19	14.5	52	M42 x 2	42	42	3/4	86

Bore size (mm)	RD	S	SS	V	Y	Z	ZZ
40	51	97	35	6.5	58	132	161.5
50	62 ^{-0.030} -0.076	98	41	8	65	139	176
63	72	105	48	12	69	153	198
80	92 ^{-0.036} -0.090	117	51	15	77	168	223.5
100	110	130	57	15	79	187	257.5

Head flange: CHSDFZ

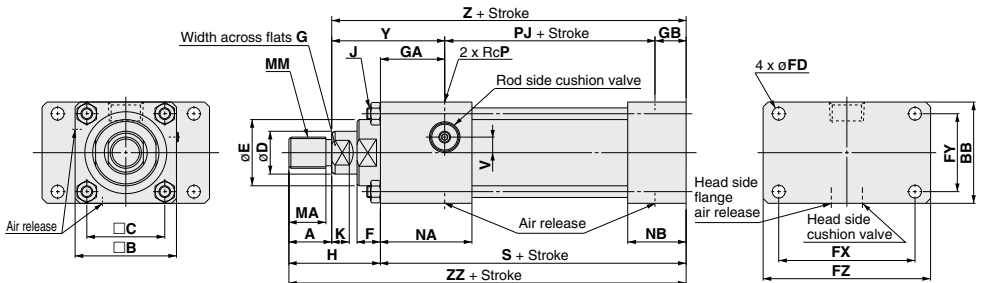

Bore size (mm)	Stroke range	A	B	BB	C	D	E	F	FD	FX	FY	FZ	G	GA	GB	H	J	K	MA	MM	NA	NB	P	PJ	S	V	Y	Z	ZZ
40	25 to 800	22	52	52	40	22	34	12	6.6	70	40	86	19	33	16	47	M6 x 1	8	19	M16 x 1.5	46	29	3/8	58	107	6.5	58	132	154
50	25 to 800	28	65	65	50	28	42	15	9	86	50	105	24	34	16	59	M8 x 1	11	25	M20 x 1.5	46.5	28.5	3/8	58	108	8	65	139	167
63	25 to 800	36	77	77	58	36	50	19	9	98	56	118	30	31	18	74	M8 x 1	13	32	M27 x 2	46	33	1/2	66	115	12	69	153	189
80	25 to 800	45	96	96	75	45	60	13	11	119	70	143	41	42	17	80	M10 x 1.25	17	41	M33 x 2	57	32	1/2	74	133	15	77	168	213
100	25 to 1000	56	115	115	90	56	72	16	13.5	138	90	162	50	38	22	97	M14 x 1.5	19	52	M42 x 2	58	42	3/4	86	148	15	79	187	243

CHQ

CHK

CHN

CHM

CHS

CH2

CHA

Related Products

D-

CHSD Series

Dimensions

Double clevis: CHSDCB

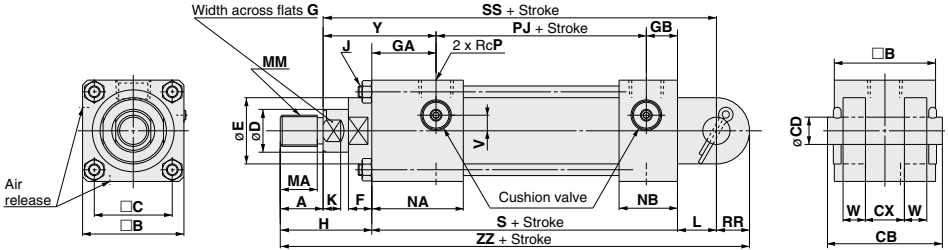

Bore size (mm)	Stroke range	A	B	C	CB	CD	CX	D	E	F	G	GA	GB	H	J	K	L	MA	MM	NA	NB	P	PJ	RR	S
40	25 to 800	22	52	40	64	14	20	22	34	12	19	33	16	47	M6 x 1	8	19	19	M16 x 1.5	46	29	3/8	58	17	107
50	25 to 800	28	65	50	64	14	20	28	42	15	24	34	16	59	M8 x 1	11	19	25	M20 x 1.5	46.5	28.5	3/8	58	17	108
63	25 to 800	36	77	58	93	20	30	36	50	19	30	31	18	74	M8 x 1	13	32	32	M27 x 2	46	33	1/2	66	29	115
80	25 to 800	45	96	75	93	20	30	45	60	13	41	42	17	80	M10 x 1.25	17	32	41	M33 x 2	57	32	1/2	74	29	133
100	25 to 1000	56	115	90	113	28	40	56	72	16	50	38	22	97	M14 x 1.5	19	39	52	M42 x 2	58	42	3/4	86	34	146

Bore size (mm)	SS	V	W	Y	ZZ
40	151	6.5	11.5	58	190
50	158	8	11.5	65	203
63	185	12	17.5	69	250
80	200	15	17.5	77	274
100	226	15	21.5	79	316

Rod trunnion: CHSDTA

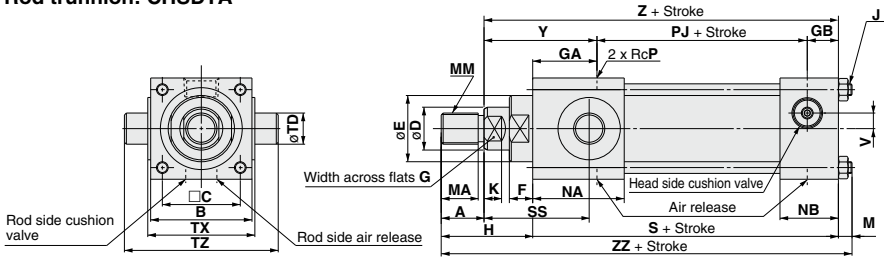

Bore size (mm)	Stroke range	A	B	C	D	E	F	G	GA	GB	H	J	K	M	MA	MM	NA	NB	P	PJ	S	SS	TD	TX	TZ
40	25 to 800	22	52	40	22	34	12	19	33	16	47	M6 x 1	8	7.5	19	M16 x 1.5	46	29	3/8	58	107	54	16 ^{+0.016} _{-0.043}	55	79
50	25 to 800	28	65	50	28	42	15	24	34	16	59	M8 x 1	11	9	25	M20 x 1.5	46.5	28.5	3/8	58	108	61	20 ^{-0.020} _{-0.053}	68	100
63	25 to 800	36	77	58	36	50	19	30	31	18	74	M8 x 1	13	9	32	M27 x 2	46	33	1/2	66	115	67	25	80	120
80	25 to 800	45	96	75	45	60	13	41	42	17	80	M10 x 1.25	17	10.5	41	M33 x 2	57	32	1/2	74	133	73	32 ^{-0.025} _{-0.064}	100	150
100	25 to 1000	56	115	90	56	72	16	50	38	22	97	M14 x 1.5	19	14.5	52	M42 x 2	58	42	3/4	86	146	79	40	120	184

Bore size (mm)	V	Z	ZZ
40	6.5	132	161.5
50	8	139	176
63	12	153	198
80	15	168	223.5
100	15	187	257.5

Accessory (Option)

Rod end nut

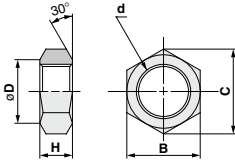

Material: Carbon steel

Part no.	Bore size (mm)	B	C	d	D	H
NTH-040	40	22	25.4	M16 x 1.6	21	10
NTH-050	50	27	31.2	M20 x 1.5	26	12
NTH-060S	63	41	47.3	M27 x 2	39	16
NTH-080S	80	50	57.7	M33 x 2	48	20
NTH-100S	100	65	75	M42 x 2	62	25

CHQ

CHK

CHN

CHM

CHS

CH2

CHA

Related Products

D-

Auto Switch Mounting

Refer to pages 431 to 490 for detailed specifications.

Auto Switch Proper Mounting Position (Detection at Stroke End) and Its Mounting Height

D-A5□/A6□
D-F5□(W)/J59(W)/F5BA

D-M9□/M9□V
D-M9□W/M9□WV
D-M9□A/M9□AV
D-Z7□/Z80

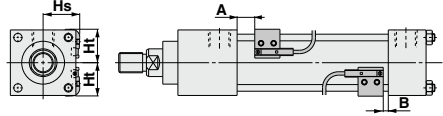
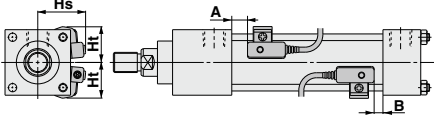

Auto Switch Proper Mounting Position

Bore size (mm)	D-M9□/M9□V D-M9□W/M9□WV D-M9□A/M9□AV		D-F5□/J59 D-F5□W/J59W D-F59F D-F5BA		D-F5NT		D-Z7□/Z80		D-A5□/A6□		D-A59W	
	A	B	A	B	A	B	A	B	A	B	A	B
	40	11.5	8.5	8	5	13	10	5	2	—	—	—
50	13	8	9.5	4.5	14.5	9.5	6.5	1.5	—	—	—	—
63	14.5	9.5	11	6	16	11	8	3	4.5	0	8.5	3.5
80	18.5	13.5	15	10	20	15	12	7	8.5	3.5	12.5	7.5
100	18.5	15.5	15	12.5	20	17.5	12	9.5	8.5	6	12.5	10

Note 1) D-A5□/A6□/A59W cannot be mounted to ø40, ø50.

Note 2) Adjust the auto switch after confirming the operating conditions in the actual setting.

Auto Switch Mounting Height

Bore size (mm)	D-M9□/M9□V D-M9□A		D-M9□W/M9□WV D-M9□AV		D-F5□/J59 D-F5□W/J59W D-F59F/F5BA D-F5NT		D-A5□/A6□ D-A59W		D-Z7□/Z80	
	Ht	Hs	Ht	Hs	Ht	Hs	Ht	Hs	Ht	Hs
	40	27	28.5	27	34	35.5	28.5	—	—	29
50	33	33.5	33	38.5	39.5	34.5	—	—	33	33
63	38.5	38	38.5	43.5	45	38.5	47.5	38.5	28	37
80	48	47	48	52	51	48	54	48	46.5	46
100	57.5	59	57.5	62.5	63.5	58	66.5	58	59	57

* D-A5□/A6□/A59W cannot be mounted to ø40, ø50.

Operating Range

Auto switch model	Bore size (mm)				
	40	50	63	80	100
D-M9□/M9□V D-M9□W/M9□WV D-M9□A/M9□AV	4.5	5	6	7.5	9
D-F5□/J59/F59F D-F5□W/J59W D-F5BA/F5NT	4	4.5	4.5	5.5	5.5
D-A5□/A6□	—	—	10.5	12	14.5
D-A59W	—	—	14	16	18
D-Z7□/Z80	8	9	10	12	14.5

* D-A5□/A6□/A59W cannot be mounted to ø40, ø50.

* Since this is a guideline including hysteresis, not meant to be guaranteed. (Assuming approximately ±30% dispersion.) There may be the case it will vary substantially depending on an ambient environment.

Minimum Auto Switch Mounting Stroke

Auto switch model	2 pcs. (Different surfaces and same surface), 1 pc.	"n" pcs.
D-M9□ D-M9□W D-M9□A	20	20 + 40 $\frac{(n-2)}{2}$ (n = 2, 4, 6, 8... Note 1)
D-M9□V D-M9□WV D-M9□AV	20	20 + 30 $\frac{(n-2)}{2}$ (n = 2, 4, 6, 8... Note 1)
D-F5□/J59/F5□W D-J59W/F5BA D-F59F/A5□/A6□	20	20 + 55 $\frac{(n-2)}{2}$ (n = 2, 4, 6, 8... Note 1)
D-D-F5NT	25	20 + 55 $\frac{(n-2)}{2}$ (n = 2, 4, 6, 8... Note 1)
D-A59W	30	20 + 55 $\frac{(n-2)}{2}$ (n = 2, 4, 6, 8... Note 1)
D-Z7□/Z80	20	20 + 40 $\frac{(n-2)}{2}$ (n = 2, 4, 6, 8... Note 1)

* D-A5□/A6□/A59W cannot be mounted to ø40, ø50.

Note 1) When "n" is an odd number, an even number that is one larger than this odd number is used for the calculation.

Besides the models listed in "How to Order," the following auto switches are applicable. Refer to pages 431 to 490 for detailed auto switch specifications.

Auto switch type	Part no.	Electrical entry	Features
Solid state	D-M9NV, M9PV, M9BV	Grommet (perpendicular)	—
	D-M9NWV, M9PWW, M9BWW		Diagnostic indication (2-color indicator)
	D-M9NAV, M9PAV, M9BAV		Water resistant (2-color indicator)
	D-F59, F5P, J59	Grommet (in-line)	—
	D-F59W, F5PW, J59W		Diagnostic indication (2-color indicator)
	D-F5BA		Water resistant (2-color indicator)
Reed	D-F5NT	Grommet (in-line)	With timer
	D-A53, A56		—
	D-A67		Without indicator light

* Solid state auto switches are also available with pre-wired connector. Contact SMC for detailed auto switch specifications. Refer to pages 474 and 475 for details.

Auto Switch Mounting Brackets: Part Nos.

Auto switch models	Bore size (mm)				
	ø40	ø50	ø63	ø80	ø100
D-M9□/M9□V D-M9□W/M9□WV D-M9□A/M9□AV	BMB5-032	BA7-040	BA7-040	BA7-063	BS5-125
D-F5□/J59 D-F5□W/J59W D-F5BA/F59F/F5NT D-A5□/A6□/A59W	BT-03	BT-04	BT-04	BT-06	BT-12
D-Z7□/Z80	BMB4-032	BA4-040	BA4-040	BA4-063	BS4-125

Note 1) D-A5□/A6□/A59W cannot be mounted to ø40, ø50.

[Stainless steel mounting screw kits]

The following stainless steel mounting screw kits are available for use depending on the operating environment. (Switch mounting bands are not included and should be ordered separately.)

BBA1 : For D-F5/J5/A5/A6 types

Note 2) Refer to the table below for details on BBA1.

Stainless mounting screw kit details

Part no.	Contents				Applicable auto switch mounting bracket part nos.	Applicable auto switches
	No.	Description	Size	Pcs.		
BBA1	1	Auto switch mounting screws	M4 x 0.7 x 8L	1	BT-□□	D-A5, A6 D-F5, J5
					BT-03, BT-04, BT-05 BT-06, BT-08, BT-12	
	2	Set screw	M4 x 0.7 x 6L	2	BA4-040, BA4-063, BA4-080 BMB4-032, BMB4-050	D-Z7, Z8 D-Y5, Y6, Y7
					BMB5-032 BA7-040, BA7-063, BA7-080	D-A9 D-M9
	3	Set screw	M4 x 0.7 x 8L	2	BT-16, BT-18A, BT-20	D-A5, A6 D-F5, J5
					BS4-125, BS4-160 BS4-180, BS4-200	D-Z7, Z8 D-Y5, Y6, Y7
			BS5-125, BS5-160 BS5-180, BS5-200		D-A9 D-M9	

When D-F5BA auto switch is shipped mounted on a cylinder, the above stainless steel screws are used. Also when switches are shipped separately, BBA1 is included.

Note 3) When using D-M9□A(V), order stainless mounting screw kit BBA1 instead of the iron auto switch mounting brackets (BMB5-032, BA7-□□□, BS5-125) in the table above, and use the M4 x 6L stainless set screws included.

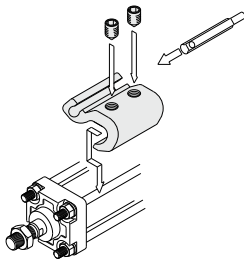

• Mounting example for D-M9□(V), M9□W(V), M9□A(V).

CHQ

CHK□

CHN

CHM

CHS□

CH2□

CHA

Related Products

D-□

How to Mount and Move the Auto Switch

<Applicable auto switch>

Solid state D-M9N(V), D-M9P(V), D-M9B(V)
 D-M9NW(V), D-M9PW(V), D-M9BW(V)
 D-M9NA(V), D-M9PA(V), D-M9BA(V)

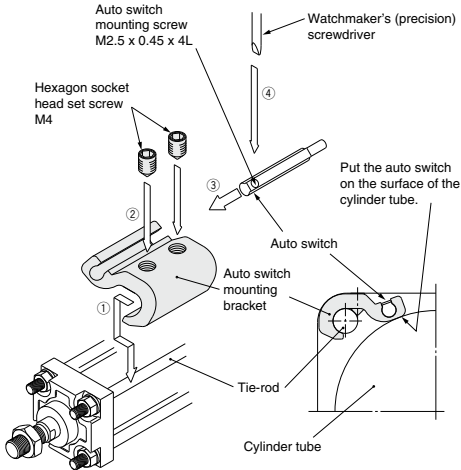

1. Fix it to the detecting position with a set screw by installing an auto switch mounting bracket in cylinder tie-rod and letting the bottom surface of an auto switch mounting bracket contact the cylinder tube firmly.
2. Fix it to the detecting position with a hexagon socket head set screw (M4). (Use a hexagon wrench.)
3. Fit an auto switch into the auto switch mounting groove to set it roughly to the mounting position for an auto switch.
4. After confirming the detecting position, tighten up the mounting screw (M2.5) attached to an auto switch, and secure the auto switch.
5. When changing the detecting position, carry out in the state of 3.

Note 1) To protect auto switches, ensure that main body of an auto switch should be embedded into auto switch mounting groove with a depth of 15 mm or more.

Note 2) Set the tightening torque of a hexagon socket head set screw (M4) to be 1 to 1.2 N·m.

Note 3) When tightening an auto switch mounting screw (M2.5), use a watchmaker's screwdriver with a grip diameter of 5 to 6 mm. Also, set the tightening torque to be 0.05 to 0.15 N·m. As a guide, turn 90° from the position where it comes to feel tight.

<Applicable auto switch>

Reed D-Z73, D-Z76, D-Z80

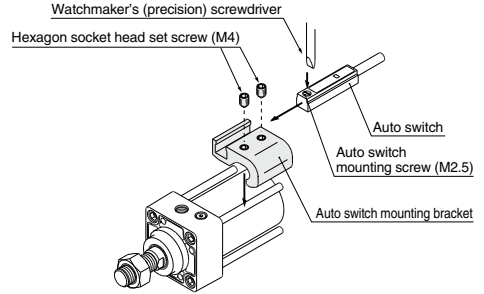

1. Fix it to the detecting position with a hexagon socket head set screw (M4) by installing an auto switch mounting bracket in cylinder tie-rod and letting the bottom surface of an auto switch mounting bracket contact the cylinder tube firmly. (Use a hexagon wrench)
2. Fit an auto switch into the auto switch mounting groove to set it roughly to the auto switch mounting position for an auto switch.
3. After confirming the detecting position, tighten up the mounting screw (M2.5) attached to an auto switch, and secure the switch.
4. When changing the detecting position, carry out in the state of 2.

Note 1) To protect auto switches, ensure that main body of an auto switch should be embedded into auto switch mounting groove with a depth of 15 mm or more.

Note 2) Set the tightening torque of a hexagon socket head set screw (M4) to be 1 to 1.2 N·m.

Note 3) When tightening an auto switch mounting screw (M2.5), use a watchmaker's screwdriver with a grip diameter of 5 to 6 mm. Also, set the tightening torque to be 0.05 to 0.15 N·m. As a guide, turn 90° from the position where it comes to feel tight.

How to Mount and Move the Auto Switch

<Applicable auto switch>

Solid state D-F59, D-F5P
 D-J59, D-F5BA
 D-F59W, D-F5PW, D-J59W
 D-F59F, D-F5NT

Reed D-A53, D-A54, D-A56, D-A64, D-A67
 D-A59W

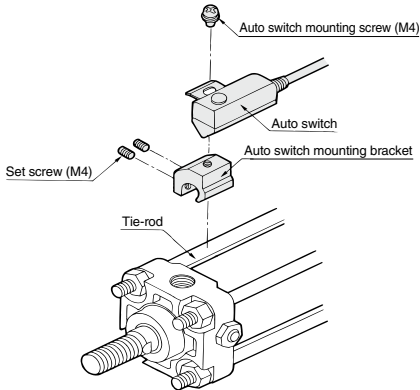

1. Fix the auto switch on the auto switch mounting bracket with the auto switch mounting screw (M4) and install the set screw.
2. Fit the auto switch mounting bracket into the cylinder tie-rod and then fix the auto switch at the detecting position with the hexagonal wrench. (Be sure to put the auto switch on the surface of cylinder tube.)
3. When changing the detecting position, loosen the set screw to move the auto switch and then re-fix the auto switch on the cylinder tube. (Tightening torque of M4 screw should be 1 to 1.2 N·m.)

CHQ

CHK

CHN

CHM

CHS

CH2

CHA

Related Products

D-

ISO Standard Hydraulic Cylinder

CHSG Series

16 MPa

ø32, ø40, ø50, ø63, ø80, ø100

How to Order

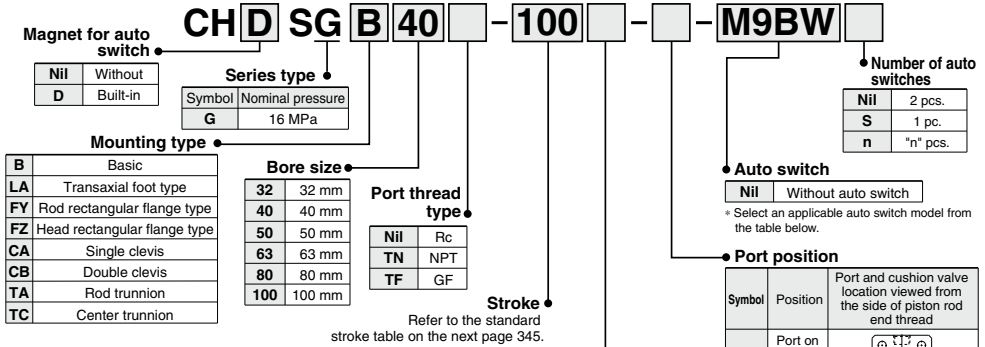

Number of auto switches

Nil	2 pcs.
S	1 pc.
n	"n" pcs.

Built-in Magnet Cylinder Model

If a built-in magnet cylinder without auto switch is required, there is no need to enter the symbol for the auto switch.

(Example) CHDSGB50-100

Applicable Auto Switches/Refer to pages 431 to 490 for further details on each auto switch.

Type	Special function	Electrical entry	Indicator light	Wiring (output)	Load voltage		Auto switch model	Lead wire length (m)					Pre-wired connector	Applicable load
					DC	AC		ø32	ø40 to ø60	ø100	(Nil)	(M)		
Solid state auto switch	Diagnostic indication (2-color indicator)	Grommet	Yes	3-wire (NPN)	24 V	5 V, 12 V	M9N	●	●	○	○	○	IC circuit	
							F59	●	●	○	○	○		
				3-wire (PNP)	12 V	M9P	●	●	○	○	—			
						F5P	●	●	○	○				
				2-wire	12 V	M9B	●	●	○	○	—			
						J59	●	●	○	○				
	Water resistant (2-color indicator)	Grommet	Yes	3-wire (NPN)	24 V	5 V, 12 V	M9NW	●	●	○	○	IC circuit		
							F59W	●	●	○	○			
				3-wire (PNP)	12 V	M9PW	●	●	○	○	—			
						F5PW	●	●	○	○				
2-wire	12 V	M9BW	●	●	○	○	—							
		J59W	●	●	○	○								
Diagnostic output (2-color indicator)	Grommet	Yes	3-wire (NPN)	24 V	5 V, 12 V	M9NA**	○	○	○	○	IC circuit			
						M9PA**	○	○	○	○				
			3-wire (PNP)	12 V	M9BA**	○	○	○	○	—				
					F5BA	○	○	○	○					
Read auto switch	Grommet	Yes	3-wire (NPN equiv.)	24 V	12 V	F59F	●	●	○	○	IC circuit			
						Z76	●	●	○	○				
						Z73	●	●	○	○				
						Z80	●	●	○	○				
Diagnostic output (2-color indicator)	Grommet	Yes	2-wire	24 V	12 V	A54	●	●	○	○	IC circuit			
						A64	●	●	○	○				
						A59W	●	●	○	○				
						—	—	—	—	—				

** Water resistant type auto switches can be mounted on the above models, but in such case SMC cannot guarantee water resistance. Consult with SMC regarding water resistant types with the above model numbers.

* Lead wire length symbols: 0.5 m Nil (Example) M9NW
 1 m M (Example) M9NWM
 3 m L (Example) M9NWL
 5 m Z (Example) M9NWZ

* Solid state auto switches marked with "○" are produced upon receipt of order.

* Besides the models in the above table, there are some other auto switches that are applicable. For more information, refer to page 353.

* For details about auto switches with pre-wired connector, refer to pages 474 and 475.

* D-M9C, M9CW, M9CA, Z7C, Z80 auto switches are shipped together, (not assembled). (Only auto switch mounting brackets are packed assembled.)

Symbol	Position	Port and cushion valve location viewed from the side of piston rod end thread
Nil	Port on top, cushion valve on the right	
A	Port on top, cushion valve on the left	
B	Port on top, cushion valve down	
C	Port on the right, cushion valve down	
D	Port on the right, cushion valve on top	
E	Port on the right, cushion valve on the left	

⇄ Piping port | Cushion valve

Note 1) Refer to table 1 for manufacturability.

Note 2) Diagrams illustrate the view from the rod on the left side of the cylinder dimensions.

Note 3) For mounting types FY, FZ, or TA, indicate port position with the symbol B.

Table 1 Manufacturing Check List by Mounting Type and Port Position

Port position	Mounting bracket	B	LA	FY	FZ	CA	CB	TA	TC
		Nil	○	○	○	○	○	○	○
A	○	○	○	○	○	○	○	○	○
B	○	○	○	○	○	○	○	○	○
C	○	○	○	○	○	○	○	○	○
D	○	○	○	○	○	○	○	○	○
E	○	○	○	○	○	○	○	○	○

○: Standard product ○: Made to Order

—: Not available due to size limitation.

Specifications

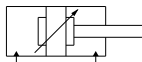

Bore size (mm)		32	40	50	63	80	100
Action		Double Acting: Single Rod					
Fluid		General mineral hydraulic fluid					
Nominal pressure		16 MPa					
Maximum allowable pressure		20 MPa					
Proof pressure		24 MPa					
Minimum operating pressure	With pressure at rod side	0.25 MPa					
	With pressure at head side	0.15 MPa					
Ambient and fluid temperature	Without magnet	-10 to 80°C					
	Built-in magnet	-10 to 60°C					
Piston speed		8 to 300 mm/s					
Cushion		Cushion seal					
Thread tolerance		JIS 6 g/6 H					
Stroke length tolerance		From 100st ^{+0.8} ₀ , 101 to 250st ^{+1.0} ₀ , 251 to 630st ^{+1.25} ₀ , 631 to 1000st ^{+1.4} ₀					

Note) Refer to page 214 for definitions of terms related to pressure.

Standard Stroke

Bore size (mm)	Standard stroke (mm)
32	25 to 800
40	25 to 800
50	25 to 800
63	25 to 800
80	25 to 800
100	25 to 1000

Theoretical Output

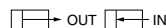

Unit: N

Bore size (mm)	Rod size (mm)	Operating direction	Piston area (mm ²)	Operating pressure (MPa)			
				3.5	7	10	16
32	18	OUT	804	2814	5628	8040	12864
		IN	549	1922	3843	5490	8784
40	22	OUT	1256	4396	8792	12560	20096
		IN	876	3066	6132	8760	14016
50	28	OUT	1963	6871	13741	19630	31408
		IN	1347	4715	9429	13470	21552
63	36	OUT	3117	10910	21819	31170	49872
		IN	2099	7346	14693	20990	33584
80	45	OUT	5026	17591	35182	50260	80416
		IN	3436	12026	24052	34360	54976
100	56	OUT	7853	27486	54971	78530	125648
		IN	5390	18865	37730	53900	86240

Theoretical output (N) = Pressure (MPa) x Piston area (mm²)

Weight

Unit: kg

Bore size (mm)			32	40	50	63	80	100
Basic weight (0 stroke)	Basic	B	1.60	3.20	4.70	7.80	14.7	20.8
	Transaxial foot	LA	1.80	4.00	5.70	8.65	17.0	23.3
	Rod flange	FY	1.90	4.10	6.00	9.10	16.7	22.9
	Head flange	FZ	1.70	3.90	5.60	8.20	16.4	24.8
	Single clevis	CA	1.60	3.40	5.60	8.20	16.4	24.8
	Double clevis	CB	1.60	3.40	5.60	8.20	16.4	24.8
	Rod trunnion	TA	1.70	3.40	5.20	8.40	15.9	22.5
	Center trunnion	TC	1.90	3.90	5.80	9.40	18.2	25.4
Additional weight per 10 strokes			0.05	0.07	0.12	0.18	0.28	0.42

CHQ

CHK

CHN

CHM

CHS

CH2

CHA

Related Products

D-

CHSG Series

Construction

CH□SGB

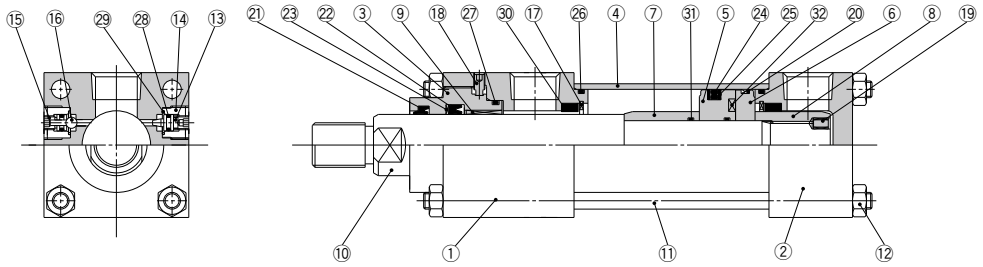

Parts List

No.	Description	Material
1	Rod cover	Carbon steel
2	Head cover	Carbon steel
3	Seal holder	Carbon steel
4	Cylinder tube	Stainless steel
5	Piston	Stainless steel
6	Magnet plate	Stainless steel
7	Cushion ring	Carbon steel
8	Cushion ring nut	Carbon steel
9	Bushing	Copper alloy
10	Piston rod	Carbon steel
11	Tie-rod	Chromium molybdenum steel
12	Tie-rod nut	Carbon steel
13	Cushion valve	Alloy steel
14	Valve holder	Carbon steel
15	Air release valve	Alloy steel
16	Check ball	Bearing steel

No.	Description	Material
17	Retaining ring	Carbon tool steel
18	Set screw	Alloy steel
19	Pin	Stainless steel
20	Wear ring	Resin
21	Scraper	NBR
22	Rod seal	NBR
23	Back-up ring	Resin
24	Piston seal	NBR
25	Back-up ring	Resin
26	Cylinder tube gasket	NBR
27	Holder gasket	NBR
28	Valve seal	NBR
29	Valve holder gasket	NBR
30	Cushion seal	—
31	Piston gasket	NBR
32	Magnet	—

Replacement Parts: Seal Kit

Bore size (mm)	Seal kit no.
32	CHSG32-PS
40	CHSG40-PS
50	CHSG50-PS
63	CHSG63-PS
80	CHSG80-PS
100	CHSG100-PS

* Seal kit consists of items 21 to 26 and 30, and can be ordered by using the seal kit number for each bore size.

Dimensions

Basic: CHSG

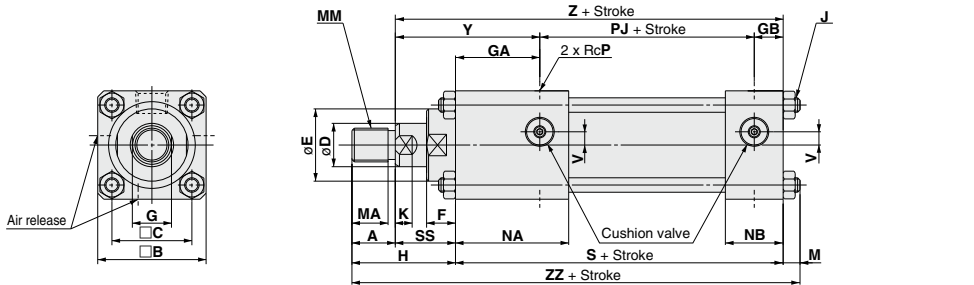

Bore size (mm)	Stroke range	A	B	C	D	E	F	G	GA	GB	H	J	K	M	MA	MM	NA	NB	P	PJ	S	SS	V	Y	Z	ZZ
32	25 to 800	18	45	33.2	18	30	12	14	35	12	43	M6 x 1	7	7.5	15	M14 x 1.5	46	23	1/4	56	103	25	5.5	60	128	153.5
40	25 to 800	22	63	41.7	22	34	12	19	37	18	47	M8 x 1	9	10	19	M16 x 1.5	51	32	3/8	73	128	25	6.5	62	153	185
50	25 to 800	28	75	52.3	28	42	9	24	42	18	53	M12 x 1.25	11	12	25	M20 x 1.5	57	33	1/2	74	134	25	7	67	159	199
63	25 to 800	36	90	64.3	36	50	13	30	39	17	68	M12 x 1.25	13	12	32	M27 x 2	55	33	1/2	80	136	32	12	71	168	216
80	25 to 800	45	115	82.7	45	60	9	41	46	20	76	M16 x 1.5	17	16	41	M33 x 2	66	40	3/4	93	159	31	15	77	190	251
100	25 to 1000	56	130	96.9	56	72	10	50	47	20	91	M16 x 1.5	19	16	52	M42 x 2	67	40	3/4	101	168	35	15	82	203	275

- CHQ
- CHK
- CHN
- CHM
- CHS
- CH2
- CHA

Related Products
 D-□

Transaxial foot: CHSGLA

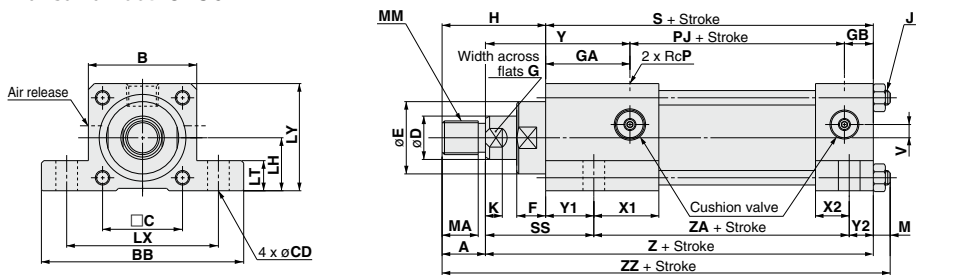

Bore size (mm)	Stroke range	A	B	BB	C	CD	D	E	F	G	GA	GB	H	J	K	LH	LT	LY	M	MA	MM	P	PJ	S	SS	
32	25 to 800	18	45	84	33.2	9	18	30	12	14	35	12	43	M6 x 1	7	22	12.5	63	44.5	7.5	15	M14 x 1.5	1/4	56	103	45
40	25 to 800	22	63	103	41.7	11	22	34	12	19	37	18	47	M8 x 1	9	31	12.5	83	62.5	10	19	M16 x 1.5	3/8	73	128	45
50	25 to 800	28	75	127	52.3	14	28	42	9	24	42	18	53	M12 x 1.25	11	37	19	102	74.5	12	25	M20 x 1.5	1/2	74	134	54
63	25 to 800	36	90	161	64.3	18	36	50	13	30	39	17	68	M12 x 1.25	13	44	26	124	89	12	32	M27 x 2	1/2	80	136	65
80	25 to 800	45	115	186	82.7	18	45	60	9	41	46	20	76	M16 x 1.5	17	57	26	149	114.5	16	41	M33 x 2	3/4	93	159	68
100	25 to 1000	56	130	216	96.9	26	56	72	10	50	47	20	91	M16 x 1.5	19	63	32	172	128	16	52	M42 x 2	3/4	101	168	79

Bore size (mm)	V	X1	X2	Y	Y1	Y2	Z	ZA	ZZ
32	5.5	26	13	60	20	10	73	128	153.5
40	6.5	31	22	62	20	10	98	153	185
50	7	28	20	67	29	13	92	159	199
63	12	22	16	71	33	17	86	168	216
80	15	29	23	77	37	17	105	190	251
100	15	23	18	82	44	22	102	203	275

CHSG Series

Dimensions

Rod flange: CHSGFY

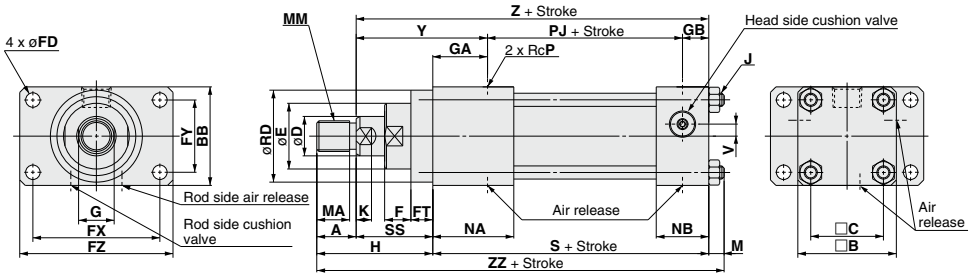

Bore size (mm)	Stroke range	A	B	BB	C	D	E	F	FD	FT	FX	FY	FZ	G	GA	GB	H	J	K	M	MA	MM	NA	NB	P	PJ
32	25 to 800	18	45	45	33.2	18	30	12	6.6	10	58	33	70	14	25	12	53	M6 x 1	7	7.5	15	M14 x 1.5	36	23	1/4	56
40	25 to 800	22	63	63	41.7	22	34	12	11	10	87	41	110	19	27	18	57	M8 x 1	9	10	19	M16 x 1.5	41	32	3/8	73
50	25 to 800	28	75	75	52.3	28	42	9	14	16	105	52	130	24	26	18	69	M12 x 1.25	11	12	25	M20 x 1.5	41	33	1/2	74
63	25 to 800	36	90	90	64.3	36	50	13	14	16	117	65	145	30	23	17	84	M12 x 1.25	13	12	32	M27 x 2	39	33	1/2	80
80	25 to 800	45	115	115	82.7	45	60	9	18	20	149	83	180	41	26	20	96	M16 x 1.5	17	16	41	M33 x 2	46	40	3/4	93
100	25 to 1000	56	130	130	96.9	56	72	10	18	22	162	97	200	50	25	20	113	M16 x 1.5	19	16	52	M42 x 2	45	40	3/4	101

Bore size (mm)	RD	S	SS	V	Y	Z	ZZ
32	42 ^{-0.025} / _{-0.064}	93	35	5.5	60	128	153.5
40	62 ^{-0.030} / _{-0.076}	118	35	6.5	62	153	185
50	74 ^{-0.030} / _{-0.076}	118	41	7	67	159	199
63	82	120	48	12	71	168	216
80	92 ^{-0.036} / _{-0.090}	139	51	15	77	190	251
100	105	146	57	15	82	203	275

Head flange: CHSGFZ

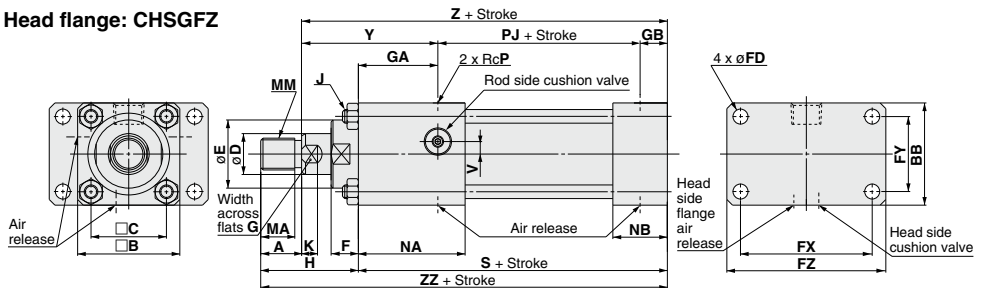

Bore size (mm)	Stroke range	A	B	BB	C	D	E	F	FD	FX	FY	FZ	G	GA	GB	H	J	K	MA	MM	NA	NB	P	PJ	S	V	Y	Z	ZZ
32	25 to 800	18	45	45	33.2	18	30	12	6.6	58	33	70	14	35	12	43	M6 x 1	7	15	M14 x 1.5	46	23	1/4	56	103	5.5	60	128	146
40	25 to 800	22	63	63	41.7	22	34	12	11	87	41	110	19	37	18	47	M8 x 1	9	19	M16 x 1.5	51	32	3/8	73	128	6.5	62	153	175
50	25 to 800	28	75	75	52.3	28	42	9	14	105	52	130	24	42	18	53	M12 x 1.25	11	25	M20 x 1.5	57	33	1/2	74	134	7	67	159	187
63	25 to 800	36	90	90	64.3	36	50	13	14	117	65	145	30	39	17	68	M12 x 1.25	13	32	M27 x 2	55	33	1/2	80	136	12	71	168	204
80	25 to 800	45	115	115	82.7	45	60	9	18	149	83	180	41	46	20	76	M16 x 1.5	17	41	M33 x 2	66	40	3/4	93	159	15	77	190	235
100	25 to 1000	56	130	130	96.9	56	72	10	18	162	97	200	50	47	20	91	M16 x 1.5	19	52	M42 x 2	67	40	3/4	101	168	15	82	203	259

Single clevis: CHSGCA

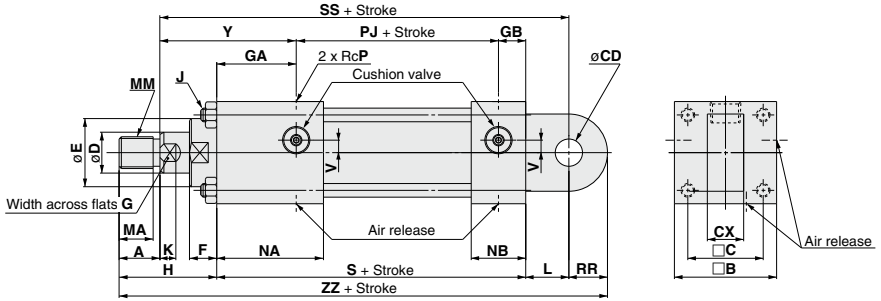

Bore size (mm)	Stroke range	A	B	C	CD	CX	D	E	F	G	GA	GB	H	J	K	L	MA	MM	NA	NB	P	PJ	RR	S	SS	V	Y	ZZ
32	25 to 800	18	45	33.2	12 ₀ ^{+0.043}	16	18	30	12	14	35	12	43	M6 x 1	7	19	15	M14 x 1.5	46	23	1/4	56	17	103	147	5.5	60	182
40	25 to 800	22	63	41.7	14 ₀ ^{+0.043}	20	22	34	12	19	37	18	47	M8 x 1	9	19	19	M16 x 1.5	51	32	3/8	73	17	128	172	6.5	62	211
50	25 to 800	28	75	52.3	20 ₀ ^{+0.052}	30	28	42	9	24	42	18	53	M12 x 1.25	11	32	25	M20 x 1.5	57	33	1/2	74	29	134	191	7	67	248
63	25 to 800	36	90	64.3	20 ₀ ^{+0.052}	30	36	50	13	30	39	17	68	M12 x 1.25	13	32	32	M27 x 2	55	33	1/2	80	29	136	200	12	71	265
80	25 to 800	45	115	82.7	28 ₀ ^{+0.062}	40	45	60	9	41	46	20	76	M16 x 1.5	17	39	41	M33 x 2	66	40	3/4	93	34	159	229	15	77	308
100	25 to 1000	56	130	96.9	36 ₀ ^{+0.062}	50	56	72	10	50	47	20	91	M16 x 1.5	19	54	52	M42 x 2	67	40	3/4	101	50	168	257	15	82	363

Double clevis: CHSGCB

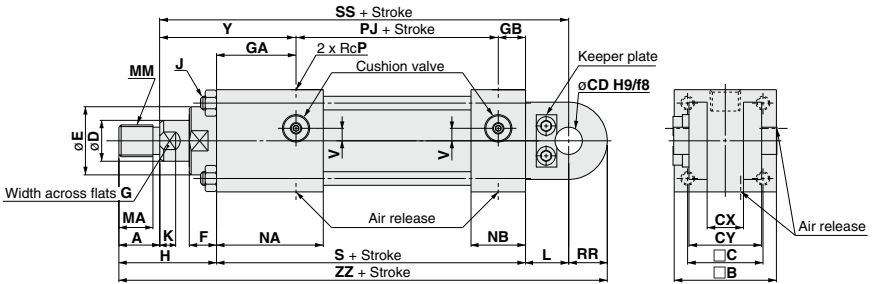

Bore size (mm)	Stroke range	A	B	C	CD	CX	CY	D	E	F	G	GA	GB	H	J	K	L	MA	MM	NA	NB	P	PJ	RR
32	25 to 800	18	45	33.2	12	16	32	18	30	12	14	35	12	43	M6 x 1	7	19	15	M14 x 1.5	46	23	1/4	56	17
40	25 to 800	22	63	41.7	14	20	43	22	34	12	19	37	18	47	M8 x 1	9	19	19	M16 x 1.5	51	32	3/8	73	17
50	25 to 800	28	75	52.3	20	30	60	28	42	9	24	42	18	53	M12 x 1.25	11	32	25	M20 x 1.5	57	33	1/2	74	29
63	25 to 800	36	90	64.3	20	30	60	36	50	13	30	39	17	68	M12 x 1.25	13	32	32	M27 x 2	55	33	1/2	80	29
80	25 to 800	45	115	82.7	28	40	80	45	60	9	41	46	20	76	M16 x 1.5	17	39	41	M33 x 2	66	40	3/4	93	34
100	25 to 1000	56	130	96.9	36	50	100	56	72	10	50	47	20	91	M16 x 1.5	19	54	52	M42 x 2	67	40	3/4	101	50

Tolerances

Bore size (mm)	S	SS	V	Y	ZZ	CD		
						H9	f8	
32	103	147	5.5	60	182	32	+0.043 0	-0.016 -0.043
40	128	172	6.5	62	211	40	+0.043 0	-0.016 -0.043
50	134	191	7	67	248	50	+0.052 0	-0.020 -0.053
63	136	200	12	71	265	63	+0.052 0	-0.020 -0.053
80	159	229	15	77	308	80	+0.062 0	-0.025 -0.064
100	168	257	15	82	363	100	+0.062 0	-0.025 -0.064

CHQ

CHK

CHN

CHM

CHS

CH2

CHA

Related Products

D-

CHSG Series

Dimensions

Rod trunnion: CHSGTA

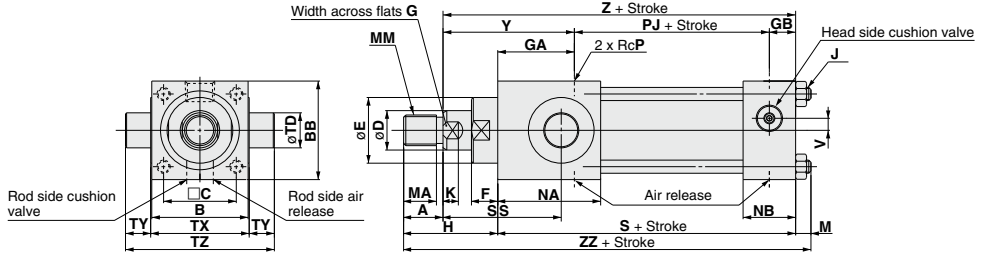

Bore size (mm)	Stroke range	A	B	BB	C	D	E	F	G	GA	GB	H	J	K	M	MA	MM	NA	NB	P	PJ	TD	TX	TZ	S	SS	V	Y	Z	ZZ
32	25 to 800	18	44	45	33.2	18	30	12	14	35	12	43	M6 x 1	7	7.5	15	M14 x 1.5	46	23	1/4	56	16 ^{-0.016}	45	68	103	54	5.5	60	128	153.5
40	25 to 800	22	61	63	41.7	22	34	12	19	37	18	47	M8 x 1	9	10	19	M16 x 1.5	51	32	3/8	73	20 ^{-0.040}	63	95	128	57	6.5	62	153	185
50	25 to 800	28	75	75	52.3	28	42	9	24	42	18	53	M12 x 1.25	11	12	25	M20 x 1.5	57	33	1/2	74	25 ^{-0.020} -0.063	76	116	134	64	7	67	159	199
63	25 to 800	36	87	90	64.3	36	50	13	30	39	17	68	M12 x 1.25	13	12	32	M27 x 2	55	33	1/2	80	32 ^{-0.025} -0.064	89	139	136	70	12	71	168	216
80	25 to 800	45	112	115	82.7	45	60	9	41	46	20	76	M16 x 1.5	17	16	41	M33 x 2	66	40	3/4	93	40	114	178	159	76	15	77	190	251
100	25 to 1000	56	125	130	96.9	56	72	10	50	47	20	91	M16 x 1.5	19	16	52	M42 x 2	67	40	3/4	101	50	127	207	168	71	15	82	203	275

Center trunnion: CHSGTC

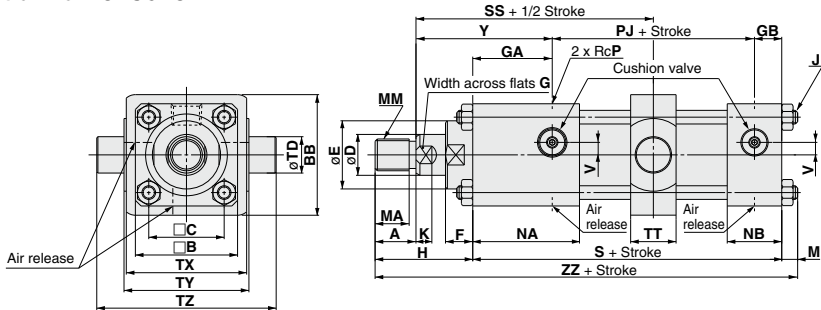

Bore size (mm)	Stroke range	A	B	BB	C	D	E	F	G	GA	GB	H	J	K	M	MA	MM	NA	NB	P	PJ	S	SS	TD	TT	TX	TY	TZ	V	Y	ZZ
32	25 to 800	18	45	57	33.2	18	30	12	14	35	12	43	M6 x 1	7	7.5	15	M14 x 1.5	46	23	1/4	56	103	88	16 ⁰	20	53	55	79	5.5	60	153.5
40	25 to 800	22	63	65	41.7	22	34	12	19	37	18	47	M8 x 1	9	10	19	M16 x 1.5	51	32	3/8	73	128	98.5	20 ^{-0.033}	26	72	76	108	6.5	62	185
50	25 to 800	28	75	75	52.3	28	42	9	24	42	18	53	M12 x 1.25	11	12	25	M20 x 1.5	57	33	1/2	74	134	104	25 ^{-0.004} -0.043	29	88	89	129	7	67	199
63	25 to 800	36	90	90	64.3	36	50	13	30	39	17	68	M12 x 1.25	13	12	32	M27 x 2	55	33	1/2	80	136	111	32	36	90	100	150	12	71	216
80	25 to 800	45	115	115	82.7	45	60	9	41	46	20	76	M16 x 1.5	17	16	41	M33 x 2	66	40	3/4	93	159	123.5	40 ^{-0.009} -0.054	44	123	127	191	15	77	251
100	25 to 1000	56	130	130	96.9	56	72	10	50	47	20	91	M16 x 1.5	19	16	52	M42 x 2	67	40	3/4	101	168	132.5	50	54	130	140	220	15	82	275

Accessory (Option)

Rod end nut

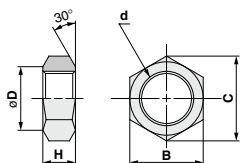

Material: Carbon steel

Part no.	Bore size (mm)	B	C	d	D	H
NTH-32S	32	22	25.4	M14 x 1.5	21	8
NTH-040	40	22	25.4	M16 x 1.6	21	10
NTH-050	50	27	31.2	M20 x 1.5	26	12
NTH-060S	63	41	47.3	M27 x 2	39	16
NTH-080S	80	50	57.7	M33 x 2	48	20
NTH-100S	100	65	75	M42 x 2	62	25

CHQ

CHK

CHN

CHM

CHS

CH2

CHA

Related Products

D-

CHSG Series Auto Switch Mounting

Refer to pages 431 to 490 for detailed specifications.

Auto Switch Proper Mounting Position (Detection at Stroke End) and Its Mounting Height

D-A5□/A6□
D-F5□(W)/J59(W)/F5BA

D-M9□/M9□V
D-M9□W/M9□WV
D-M9□A/M9□AV
D-Z7□/Z80

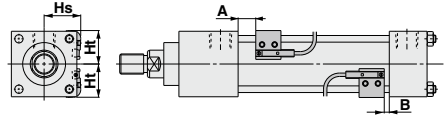
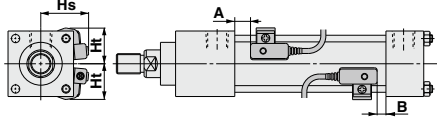

Proper Auto Switch Mounting Position

Bore size (mm)	D-M9□/M9□V D-M9□W/M9□WV D-M9□A/M9□AV		D-F5□/J59 D-F5□W/J59W D-F59F D-F5BA		D-F5NT		D-Z7□/Z80		D-A5□/A6□		D-A59W	
	A	B	A	B	A	B	A	B	A	B	A	B
32	14	8	10.5	4.5	15.5	9.5	—	—	—	—	—	—
40	22.5	10.5	19	7	24	12	16	4	12.5	0.5	16.5	4.5
50	22.5	9.5	19	6	24	11	16	3	12.5	0	16.5	3.5
63	24.5	11.5	21	8	26	13	18	5	14.5	1.5	18.5	5.5
80	27.5	13.5	24	10	29	15	21	7	17.5	3.5	21.5	7.5
100	—	—	27.5	14.5	32.5	19.5	24.5	11.5	21	8	25	12

Note 1) D-M9□, M9□V, M9□W, M9□WV, M9□A, M9□AV cannot be mounted to ø100.

Note 2) D-A5□, A6□, A59W, Z7□, Z80 cannot be mounted to ø32.

Note 3) Adjust the auto switch after confirming the operating conditions in the actual setting.

Auto Switch Mounting Height

Bore size (mm)	D-M9□/M9□V D-M9□A		D-M9□W/M9□WV D-M9□AV		D-F5□/J59 D-F5□W/J59W D-F59F/F5BA D-F5NT		D-A5□/A6□ D-A59W		D-Z7□/Z80	
	Hs	Ht	Hs	Ht	Hs	Ht	Hs	Ht	Hs	Ht
	32	25	23	31	23	32.5	25	—	—	—
40	29	28.5	34	28.5	36	30	38.5	30	29	28.5
50	37	36	41	36	41	37.5	43.5	37.5	37	36
63	43	42	47.5	42	46.5	43.5	49	43.5	42.5	42
80	54	54	55.5	54	57	56.5	59.5	56.5	54	54.5
100	—	—	—	—	66	64.5	69	64.5	62.5	61.5

Note 1) D-M9□, M9□V, M9□W, M9□WV, M9□A, M9□AV cannot be mounted to ø100.

Note 2) D-A5□, A6□, A59W, Z7□, Z80 cannot be mounted to ø32.

Operating Range

Auto switch model	Bore size (mm)					
	32	40	50	63	80	100
D-M9□/M9□V D-M9□W/M9□WV D-M9□A/M9□AV	4	4.5	5.5	7.5	8.5	—
D-F5□/J59/F59F D-F5□W/J59W D-F5BA/F5NT	4	4.5	5	4	5.5	6.5
D-A5□/A6□	—	9	10	11	14	17.5
D-A59W	—	12.5	13	14.5	17.5	22
D-Z7□/Z80	—	8.5	9.5	10.5	14.5	19.5

* D-M9□, M9□V, M9□W, M9□WV, M9□A, M9□AV cannot be mounted to ø100.

* D-A5□, A6□, A59W, Z7□, Z80 cannot be mounted to ø32.

* Since this is a guideline including hysteresis, not meant to be guaranteed. (Assuming approximately ±30% dispersion.)

There may be the case it will vary substantially depending on an ambient environment.

Minimum Auto Switch Mounting Stroke

Auto switch model	Auto switch mounting number	Mounting bracket other than center trunnion	Center trunnion						
			32	40	50	63	80	100	
D-M9□/M9□W	"n" pcs.	2 (Different surfaces and same surface), 1	20	85	95	100	105	115	—
		$20 + 40 \frac{(n-2)}{2}$ (n=2, 4, 6, 8,...) Note 3)	$85 + 40 \frac{(n-4)}{2}$ (n=4, 8, 12, 16,...) Note 4)	$95 + 40 \frac{(n-4)}{2}$ (n=4, 8, 12, 16,...) Note 4)	$100 + 40 \frac{(n-4)}{2}$ (n=4, 8, 12, 16,...) Note 4)	$105 + 40 \frac{(n-4)}{2}$ (n=4, 8, 12, 16,...) Note 4)	$115 + 40 \frac{(n-4)}{2}$ (n=4, 8, 12, 16,...) Note 4)	—	
D-M9□VM9□WV	"n" pcs.	2 (Different surfaces and same surface), 1	20	65	75	80	85	95	—
		$20 + 30 \frac{(n-2)}{2}$ (n=2, 4, 6, 8,...) Note 3)	$65 + 30 \frac{(n-4)}{2}$ (n=4, 8, 12, 16,...) Note 4)	$75 + 30 \frac{(n-4)}{2}$ (n=4, 8, 12, 16,...) Note 4)	$80 + 30 \frac{(n-4)}{2}$ (n=4, 8, 12, 16,...) Note 4)	$85 + 30 \frac{(n-4)}{2}$ (n=4, 8, 12, 16,...) Note 4)	$95 + 30 \frac{(n-4)}{2}$ (n=4, 8, 12, 16,...) Note 4)	—	
D-M9□A	"n" pcs.	2 (Different surfaces and same surface), 1	25	100	115	120	125	135	—
		$25 + 40 \frac{(n-2)}{2}$ (n=2, 4, 6, 8,...) Note 3)	$100 + 40 \frac{(n-4)}{2}$ (n=4, 8, 12, 16,...) Note 4)	$115 + 40 \frac{(n-4)}{2}$ (n=4, 8, 12, 16,...) Note 4)	$120 + 40 \frac{(n-4)}{2}$ (n=4, 8, 12, 16,...) Note 4)	$125 + 40 \frac{(n-4)}{2}$ (n=4, 8, 12, 16,...) Note 4)	$135 + 40 \frac{(n-4)}{2}$ (n=4, 8, 12, 16,...) Note 4)	—	
D-M9□AV	"n" pcs.	2 (Different surfaces and same surface), 1	25	100	115	120	125	135	—
		$25 + 30 \frac{(n-2)}{2}$ (n=2, 4, 6, 8,...) Note 3)	$100 + 30 \frac{(n-4)}{2}$ (n=4, 8, 12, 16,...) Note 4)	$115 + 30 \frac{(n-4)}{2}$ (n=4, 8, 12, 16,...) Note 4)	$120 + 30 \frac{(n-4)}{2}$ (n=4, 8, 12, 16,...) Note 4)	$125 + 30 \frac{(n-4)}{2}$ (n=4, 8, 12, 16,...) Note 4)	$135 + 30 \frac{(n-4)}{2}$ (n=4, 8, 12, 16,...) Note 4)	—	
D-F5□/J59 D-F5□W/J59W D-F5BA/F59F	"n" pcs.	2 (Different surfaces and same surface), 1	20	110	125	130	135	140	150
		$20 + 55 \frac{(n-2)}{2}$ (n=2, 4, 6, 8,...) Note 3)	$110 + 55 \frac{(n-4)}{2}$ (n=4, 8, 12, 16,...) Note 4)	$125 + 55 \frac{(n-4)}{2}$ (n=4, 8, 12, 16,...) Note 4)	$130 + 55 \frac{(n-4)}{2}$ (n=4, 8, 12, 16,...) Note 4)	$135 + 55 \frac{(n-4)}{2}$ (n=4, 8, 12, 16,...) Note 4)	$140 + 55 \frac{(n-4)}{2}$ (n=4, 8, 12, 16,...) Note 4)	$150 + 55 \frac{(n-4)}{2}$ (n=4, 8, 12, 16,...) Note 4)	
D-F5NT	"n" pcs.	2 (Different surfaces and same surface), 1	25	125	140	145	150	155	165
		$25 + 55 \frac{(n-2)}{2}$ (n=2, 4, 6, 8,...) Note 3)	$125 + 55 \frac{(n-4)}{2}$ (n=4, 8, 12, 16,...) Note 4)	$140 + 55 \frac{(n-4)}{2}$ (n=4, 8, 12, 16,...) Note 4)	$145 + 55 \frac{(n-4)}{2}$ (n=4, 8, 12, 16,...) Note 4)	$150 + 55 \frac{(n-4)}{2}$ (n=4, 8, 12, 16,...) Note 4)	$155 + 55 \frac{(n-4)}{2}$ (n=4, 8, 12, 16,...) Note 4)	$165 + 55 \frac{(n-4)}{2}$ (n=4, 8, 12, 16,...) Note 4)	
D-A5□/A6□	"n" pcs.	2 (Different surfaces and same surface), 1	25	—	120	120	130	135	145
		$25 + 55 \frac{(n-2)}{2}$ (n=2, 4, 6, 8,...) Note 3)	—	$120 + 55 \frac{(n-4)}{2}$ (n=4, 8, 12, 16,...) Note 4)	$120 + 55 \frac{(n-4)}{2}$ (n=4, 8, 12, 16,...) Note 4)	$130 + 55 \frac{(n-4)}{2}$ (n=4, 8, 12, 16,...) Note 4)	$135 + 55 \frac{(n-4)}{2}$ (n=4, 8, 12, 16,...) Note 4)	$145 + 55 \frac{(n-4)}{2}$ (n=4, 8, 12, 16,...) Note 4)	
D-A59W	"n" pcs.	2 (Different surfaces and same surface), 1	30	—	125	130	135	145	155
		$30 + 55 \frac{(n-2)}{2}$ (n=2, 4, 6, 8,...) Note 3)	—	$125 + 55 \frac{(n-4)}{2}$ (n=4, 8, 12, 16,...) Note 4)	$130 + 55 \frac{(n-4)}{2}$ (n=4, 8, 12, 16,...) Note 4)	$135 + 55 \frac{(n-4)}{2}$ (n=4, 8, 12, 16,...) Note 4)	$145 + 55 \frac{(n-4)}{2}$ (n=4, 8, 12, 16,...) Note 4)	$155 + 55 \frac{(n-4)}{2}$ (n=4, 8, 12, 16,...) Note 4)	
D-Z7□/Z80	"n" pcs.	2 (Different surfaces and same surface), 1	25	—	95	100	105	115	125
		$25 + 40 \frac{(n-2)}{2}$ (n=2, 4, 6, 8,...) Note 3)	—	$95 + 40 \frac{(n-4)}{2}$ (n=4, 8, 12, 16,...) Note 4)	$100 + 40 \frac{(n-4)}{2}$ (n=4, 8, 12, 16,...) Note 4)	$105 + 40 \frac{(n-4)}{2}$ (n=4, 8, 12, 16,...) Note 4)	$115 + 40 \frac{(n-4)}{2}$ (n=4, 8, 12, 16,...) Note 4)	$125 + 55 \frac{(n-4)}{2}$ (n=4, 8, 12, 16,...) Note 4)	

Note 1) D-M9□, M9□V, M9□W, M9□WV, M9□A, M9□AV cannot be mounted to ø100.

Note 2) D-A5□, A6□, A59W, Z7□, Z80 cannot be mounted to ø32.

Note 3) When "n" is an odd number, an even number that is one larger than this odd number is used for the calculation.

Note 4) When "n" is an odd number, a multiple of 4 that is larger than this odd number is used for the calculation.

Besides the models listed in "How to Order," the following auto switches are applicable.
Refer to pages 431 to 490 for detailed auto switch specifications.

Auto switch type	Part no.	Electrical entry	Features
Solid state	D-M9NV, M9PV, M9BV	Grommet (perpendicular)	—
	D-M9NWW, M9PWV, M9BWW		Diagnostic indication (2-color indicator)
	D-M9NAV, M9PAV, M9BAV		Water resistant (2-color indicator)
	D-F59, F5P, J59	Grommet (in-line)	—
	D-F59W, F5PW, J59W		Diagnostic indication (2-color indicator)
Reed	D-F5BA	Grommet (in-line)	Water resistant (2-color indicator)
	D-F5NT		With timer
	D-A53, A56 D-A67		— Without indicator light

* Solid state auto switches are also available with pre-wired connector. Contact SMC for detailed auto switch specifications.
Refer to pages 474 and 475 for details.

CHQ

CHK□

CHN

CHM

CHS□

CHZ□

CHA

Related Products

D-□

Auto Switch Mounting Brackets: Part Nos.

Auto switch models	Bore size (mm)					
	ø32	ø40	ø50	ø63	ø80	ø100
D-M9□/M9□V D-M9□W/M9□WV D-M9□A/M9□AV	BMB5-032	BA7-040	BA7-080	BA7-080	BS5-160	—
D-F5□/J59 D-F5□W/J59W D-F5BA/F59F/F5NT D-A5□/A6□/A59W	BT-03	BT-04	BT-08	BT-08	BT-16	BT-16
D-Z7□/Z80	—	BMB4-050	BA4-080	BA4-080	BS4-160	BS4-160

Note 1) D-M9 cannot be mounted to ø100.

Note 2) D-A5□/A6□/A59W/Z7□/Z80 cannot be mounted to ø32.

[Stainless steel mounting screw kits]

The following stainless steel mounting screw kits are available for use depending on the operating environment. (Switch mounting bands are not included and should be ordered separately.)

BBA1 : D-F5, J5, A5, A6

Note 3) Refer to the table below for details on BBA1.

Stainless mounting screw kit details

Part no.	Contents				Applicable auto switch mounting bracket part nos.	Applicable auto switches
	No.	Description	Size	Pcs.		
BBA1	1	Auto switch mounting screws	M4 x 0.7 x 8L	1	BT-□□	D-A5, A6 D-F5, J5
	2	Set screw	M4 x 0.7 x 6L	2	BT-03, BT-04, BT-05 BT-06, BT-08, BT-12	D-Z7, Z8 D-Y5, Y6, Y7
					BA4-040, BA4-063, BA4-080 BMB4-032, BMB4-050	
					BMB5-032 BA7-040, BA7-063, BA7-080	
	3	Set screw	M4 x 0.7 x 8L	2	BT-16, BT-18A, BT-20	D-A5, A6 D-F5, J5
					BS4-125, BS4-160 BS4-180, BS4-200	
BS5-125, BS5-160 BS5-180, BS5-200						

When D-F5BA auto switch is shipped mounted on a cylinder, the above stainless steel screws are used. Also when switches are shipped separately, BBA1 is included.

Note 4) When using D-M9□A(V), order stainless mounting screw kit BBA1 instead of the iron auto switch mounting brackets (BMB5-032, BA7-□□□, BS5-160) in the table above, and use the M4 x 6L stainless set screws included.

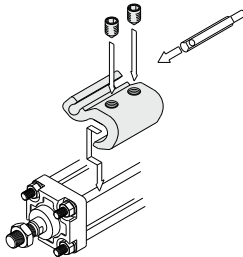

• Mounting example for D-M9□(V), M9□W(V), M9□A(V).

How to Mount and Move the Auto Switch

<Applicable auto switch>

Solid state D-M9N(V), D-M9P(V), D-M9B(V)
 D-M9NW(V), D-M9PW(V), D-M9BW(V)
 D-M9NA(V), D-M9PA(V), D-M9BA(V)

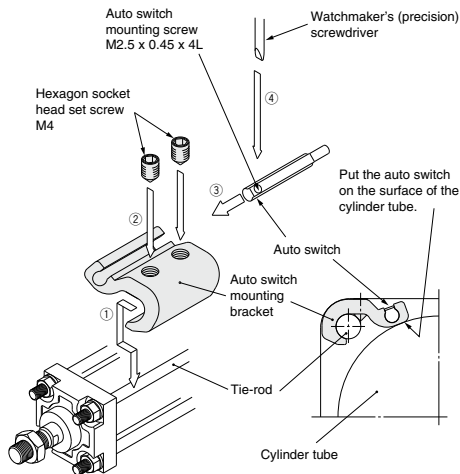

1. Fix it to the detecting position with a set screw by installing an auto switch mounting bracket in cylinder tie-rod and letting the bottom surface of an auto switch mounting bracket contact the cylinder tube firmly.
2. Fix it to the detecting position with a hexagon socket head set screw (M4). (Use a hexagon wrench.)
3. Fit an auto switch into the auto switch mounting groove to set it roughly to the mounting position for an auto switch.
4. After confirming the detecting position, tighten up the mounting screw (M2.5) attached to an auto switch, and secure the auto switch.
5. When changing the detecting position, carry out in the state of 3.

Note 1) To protect auto switches, ensure that main body of an auto switch should be embedded into auto switch mounting groove with a depth of 15 mm or more.

Note 2) Set the tightening torque of a hexagon socket head set screw (M4) to be 1 to 1.2 N·m.

Note 3) When tightening an auto switch mounting screw (M2.5), use a watchmaker's screwdriver with a grip diameter of 5 to 6 mm. Also, set the tightening torque to be 0.05 to 0.15 N·m. As a guide, turn 90° from the position where it comes to feel tight.

<Applicable auto switch>

Reed D-Z73, D-Z76, D-Z80

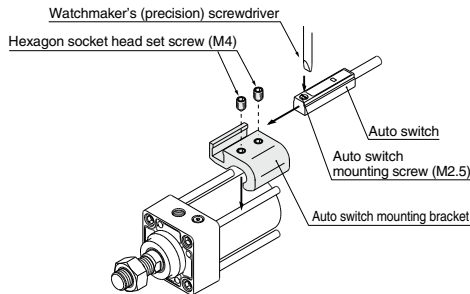

1. Fix it to the detecting position with a hexagon socket head set screw (M4) by installing an auto switch mounting bracket in cylinder tie-rod and letting the bottom surface of an auto switch mounting bracket contact the cylinder tube firmly. (Use a hexagon wrench)
2. Fit an auto switch into the auto switch mounting groove to set it roughly to the auto switch mounting position for an auto switch.
3. After confirming the detecting position, tighten up the mounting screw (M2.5) attached to an auto switch, and secure the switch.
4. When changing the detecting position, carry out in the state of 2.

Note 1) To protect auto switches, ensure that main body of an auto switch should be embedded into auto switch mounting groove with a depth of 15 mm or more.

Note 2) Set the tightening torque of a hexagon socket head set screw (M4) to be 1 to 1.2 N·m.

Note 3) When tightening an auto switch mounting screw (M2.5), use a watchmaker's screwdriver with a grip diameter of 5 to 6 mm. Also, set the tightening torque to be 0.05 to 0.15 N·m. As a guide, turn 90° from the position where it comes to feel tight.

CHQ

CHK

CHN

CHM

CHS

CH2

CHA

Related Products

D-

How to Mount and Move the Auto Switch

<Applicable auto switch>

- Solid state D-F59, D-F5P
D-J59, D-F5BA
D-F59W, D-F5PW, D-J59W
D-F59F, D-F5NT
- Reed D-A53, D-A54, D-A56, D-A64, D-A67
D-A59W

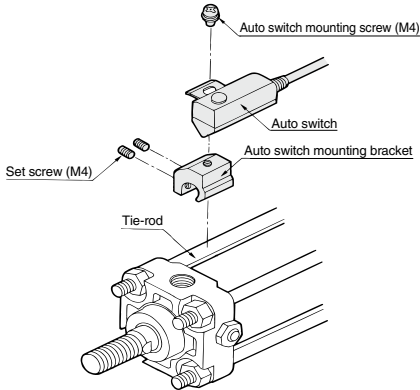

1. Fix the auto switch on the auto switch mounting bracket with the auto switch mounting screw (M4) and install the set screw.
2. Fit the auto switch mounting bracket into the cylinder tie-rod and then fix the auto switch at the detecting position with the hexagonal wrench. (Be sure to put the auto switch on the surface of cylinder tube.)
3. When changing the detecting position, loosen the set screw to move the auto switch and then re-fix the auto switch on the cylinder tube. (Tightening torque of M4 screw should be 1 to 1.2 N·m.)