

180° Angular Type Air Gripper Rack & Pinion Type

MHW2 Series

∅20, ∅25, ∅32, ∅40, ∅50

How to Order

MHW2 - 20 [] D 1 - M9BW [] - []

Number of fingers
2 2 fingers

Bore size

20	20 mm
25	25 mm
32	32 mm
40	40 mm
50	50 mm

Port thread type

Symbol	Type	Size
Nil	M thread	∅20, ∅25
	Rc	∅32
TN	NPT	∅40
TF	G	∅50

Action
D Double acting

Made to Order
Refer to page 712 for details.

Number of auto switches

Nil	2 pcs.
S	1 pc.
n	n pc.

Auto switch

Nil	Without auto switch (Built-in magnet)
-----	---------------------------------------

*For the applicable auto switch model, refer to the table below.

Finger option

Nil: Flat type fingers (Standard)
1: Right angle type fingers tapped mounting

Applicable Auto Switches / Refer to pages 797 to 850 for further information on auto switches.

Type	Special function	Electrical entry	Indicator light	Wiring (Output)	Load voltage		Auto switch model		Lead wire length (m)*				Pre-wired connector	Applicable load	
					DC	AC	Electrical entry direction		0.5 (Nil)	1 (M)	3 (L)	5 (Z)			
							Perpendicular	In-line							
Solid state auto switch	—	Grommet	Yes	3-wire(NPN)	5 V, 12 V	—	M9NV	M9N	●	●	●	○	○	IC circuit	
				3-wire(PNP)			M9PV	M9P	●	●	●	○	○		
				2-wire	12 V	—	M9BV	M9B	●	●	●	○	○		—
				3-wire(NPN)			M9NVW	M9NW	●	●	●	○	○		IC circuit
				3-wire(PNP)	5 V, 12 V	—	M9PWV	M9PW	●	●	●	○	○		—
				2-wire			M9BWW	M9BW	●	●	●	○	○		—
	Water resistant (2-color indicator)	Grommet	Yes	3-wire(NPN)	5 V, 12 V	—	M9NAV**	M9NA**	○	○	●	○	○	IC circuit	
				3-wire(PNP)			M9PAV**	M9PA**	○	○	●	○	○	IC circuit	
				2-wire	12 V	—	M9BAV**	M9BA**	○	○	●	○	○	—	

** Water resistant type auto switches can be mounted on the above models, but in such case SMC cannot guarantee water resistance.

* Lead wire length symbols: 0.5 m Nil (Example) M9NW
1 m M (Example) M9NWM
3 m L (Example) M9NWL
5 m Z (Example) M9NWZ

* Auto switches marked with a "○" symbol are produced upon receipt of order.

Note 1) When using the 2-color indicator type, please make the setting so that the indicator is lit in red to ensure the detection at the proper position of the air gripper.

Note 2) When ordering the air gripper with the auto switch, the auto switch mounting bracket is included.
When ordering the auto switch separately, the auto switch mounting bracket (BMG2-012) is required.

MHZ
MHF
MHL
MHR
MHK
MHS
MHC
MHT
MHY
MHW
-X□
MRHQ
MA
D-□

MHW2 Series



Specifications

Fluid	Air
Operating pressure	0.15 to 0.7 MPa
Ambient and fluid temperature	-10 to 60°C
Repeatability	±0.2 mm
Max. operating frequency	ø20, 25: 60 c.p.m. ø32 to 50: 30 c.p.m.
Lubrication	Not required
Action	Double acting
Auto switch (Option) ^{Note)}	Solid state auto switch (3-wire, 2-wire)

Note) Refer to pages 797 to 850 for further information on auto switches.

Symbol

Double acting: External grip

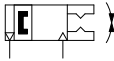

Model

Model	Bore size (mm)	Effective gripping force (N·m)	Opening angle (Both sides)		Weight ⁽²⁾ (g)
			Opening	Closing	
MHW2-20D	20	0.30	180°	-5°	300
MHW2-20D1					320
MHW2-25D	25	0.73		-6°	510
MHW2-25D1					540
MHW2-32D	32	1.61		-5°	910
MHW2-32D1					950
MHW2-40D	40	3.70	-5°	2140	
MHW2-40D1				2270	
MHW2-50D	50	8.27	-4°	5100	
MHW2-50D1				5350	

Note 1) At the pressure of 0.5 MPa

Note 2) Except auto switch

- Refer to "How to Select the Applicable Model" on page 700
- Refer to pages 700 and 701 for the details on effective holding force and allowable overhanging distance.

Made to Order

Made to Order

(Refer to pages 725 to 748 for the details.)

Symbol	Specifications/Description
-X4	Heat resistance
-X5	Fluororubber seal
-X50	Without magnet
-X53	EPDM for seals, Fluorine grease
-X63	Fluorine grease
-X79	Grease for food processing machines, Fluorine grease
-X79A	Grease for food processing machines

⚠ Precautions

Be sure to read this before handling the products.

Refer to back page 50 for Safety Instructions and pages 366 to 374 for Air Gripper and Auto Switch Precautions.

Mounting

MHW

⚠ Warning

When using right angle finger tap mounting type, monitor the interference of the bolt with the speed controller.

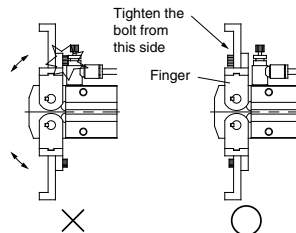

Bolt interferes with speed controller

Construction

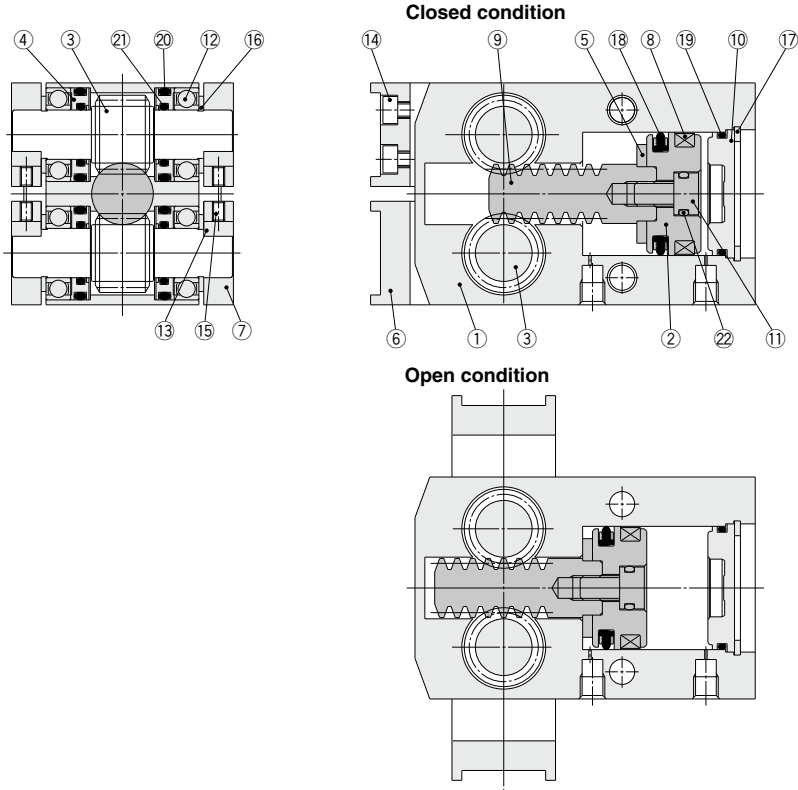

Component Parts

No.	Description	Material	Note
1	Body	Aluminum alloy	Hard anodized
2	Piston	Aluminum alloy	Hard anodized
3	Pinion gear	Carbon steel	Heat treated
4	Seal cover	Brass	
5	Bumper	Urethane rubber	
6	Finger (A)	Carbon steel	Nitriding
7	Finger (B)	Carbon steel	Nitriding
8	Rubber magnet	Synthetic rubber	
9	Rack	Carbon steel	Nitriding

No.	Description	Material	Note
10	Cap	ø20, 25: Resin ø32 to 50: Aluminum alloy	Hard anodized
11	Piston bolt	Stainless steel	
12	Ball bearing	Carbon steel	Schield type
13	Key	Carbon steel	
14	Hexagon socket head bolt	Carbon steel	Zinc chromated
15	Hexagon socket cap screw	Carbon steel	Zinc chromated
16	Type C retaining ring	Carbon steel	Phosphate coated
17	Type C retaining ring	Carbon steel	Phosphate coated

Replacement Parts

Description	MHW2-20	MHW2-25	MHW2-32	MHW2-40	MHW2-50	Main parts	
Seal kit	MHW20-PS	MHW25-PS	MHW32-PS	MHW40-PS	MHW50-PS	(18)(19)(20)(21)(22)	
Piston assembly	MHW-A2001	MHW-A2501	MHW-A3201	MHW-A4001	MHW-A5001	(2)(5)(8)(9)(11)(22)	
Finger assembly	MHW2-□D	MHW-A2002	MHW-A2502	MHW-A3202	MHW-A4002	MHW-A5002	
	MHW2-□D1	MHW-A2002-1	MHW-A2502-1	MHW-A3202-1	MHW-A4002-1	MHW-A5002-1	(6)(7)(13)(14)(15)
Finger A assembly	MHW2-□D	MHW-A2006	MHW-A2506	MHW-A3206	MHW-A4006	MHW-A5006	(6)(14)
Finger C assembly	MHW2-□D1	MHW-A2006-1	MHW-A2506-1	MHW-A3206-1	MHW-A4006-1	MHW-A5006-1	(6)(14)
Finger B assembly	MHW-A2007	MHW-A2507	MHW-A3207	MHW-A4007	MHW-A5007	(7)(13)(15)	

* Please order 1 piece finger assembly per one unit.

Replacement part/grease pack part no. :

ø20, ø25, ø32 : GR-S-010(10 g)

ø40, 50 : GR-S-020(20 g)

MHZ
MHF
MHL
MHR
MHK
MHS
MHC
MHT
MHY
MHW
-X□
MRHQ
MA
D-□

MHW2 Series

Dimensions

MHW2-20D

Flat finger type (Standard)

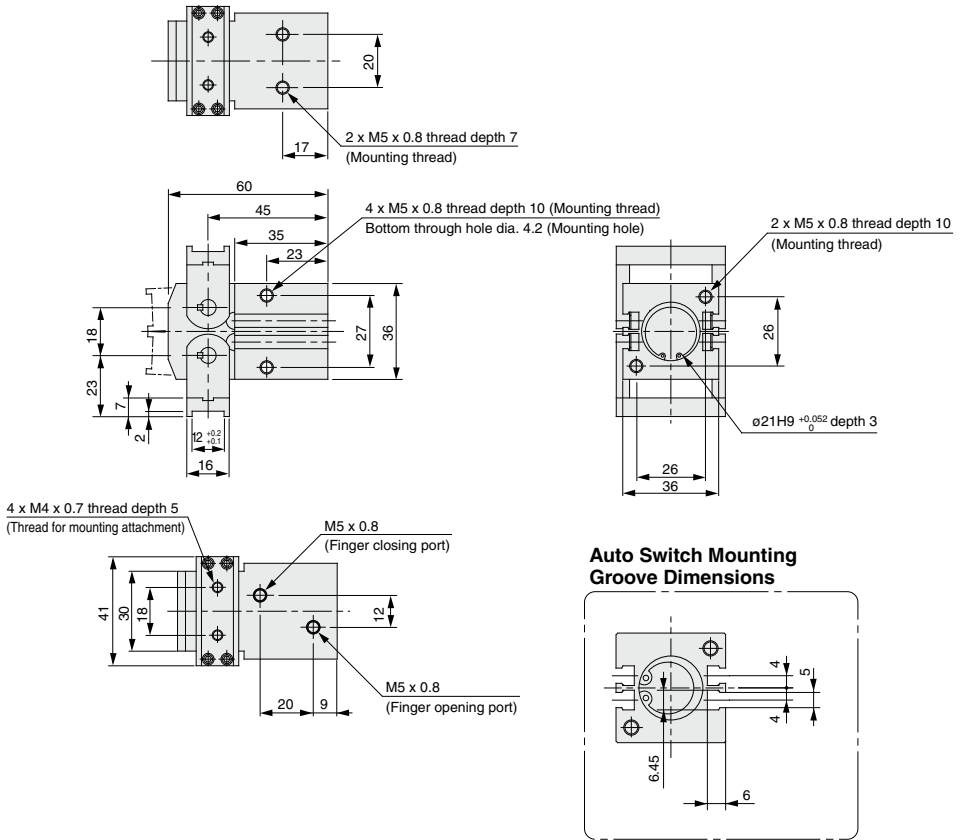

MHW2-20D1

Right angle finger type

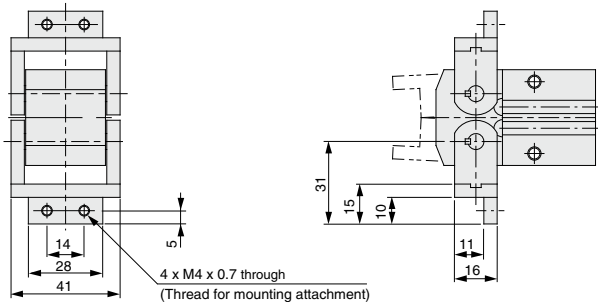

Dimensions

MHW2-25D

Flat finger type (Standard)

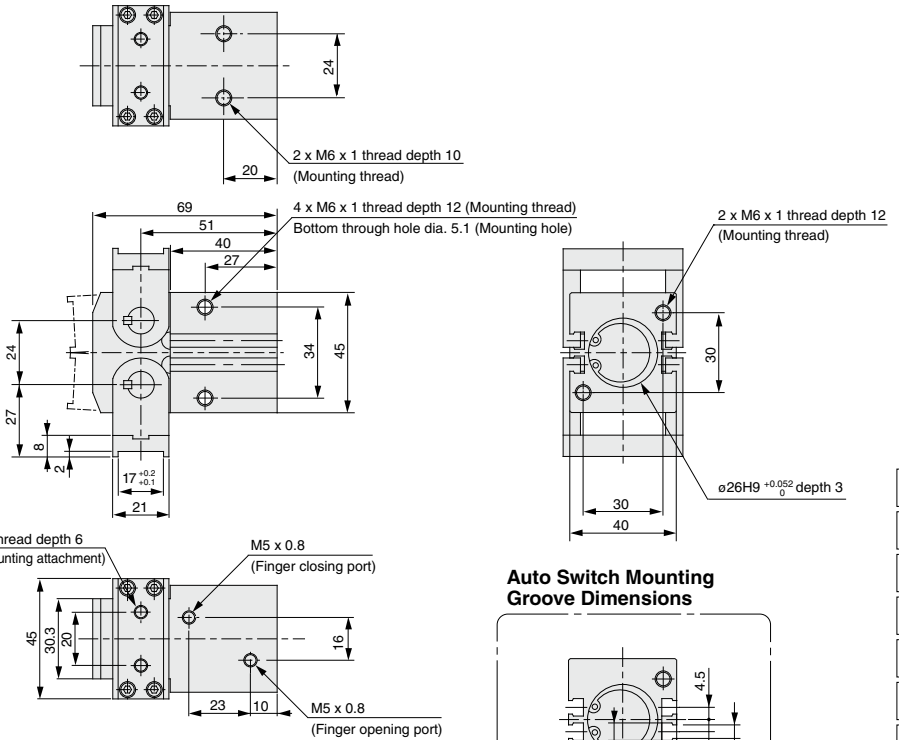

**Auto Switch Mounting
Groove Dimensions**

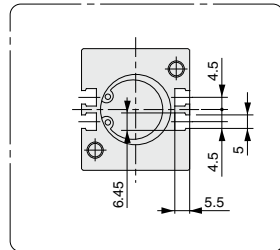

MHW2-25D1

Right angle finger type

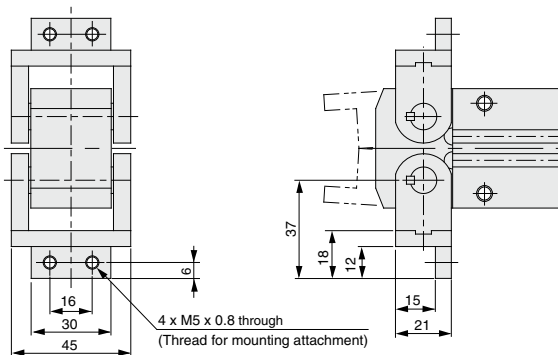

- MHZ
- MHF
- MHL
- MHR
- MHK
- MHS
- MHC
- MHT
- MHY
- MHW
- X□
- MRHQ
- MA
- D-□

MHW2 Series

Dimensions

MHW2-32D

Flat finger type (Standard)

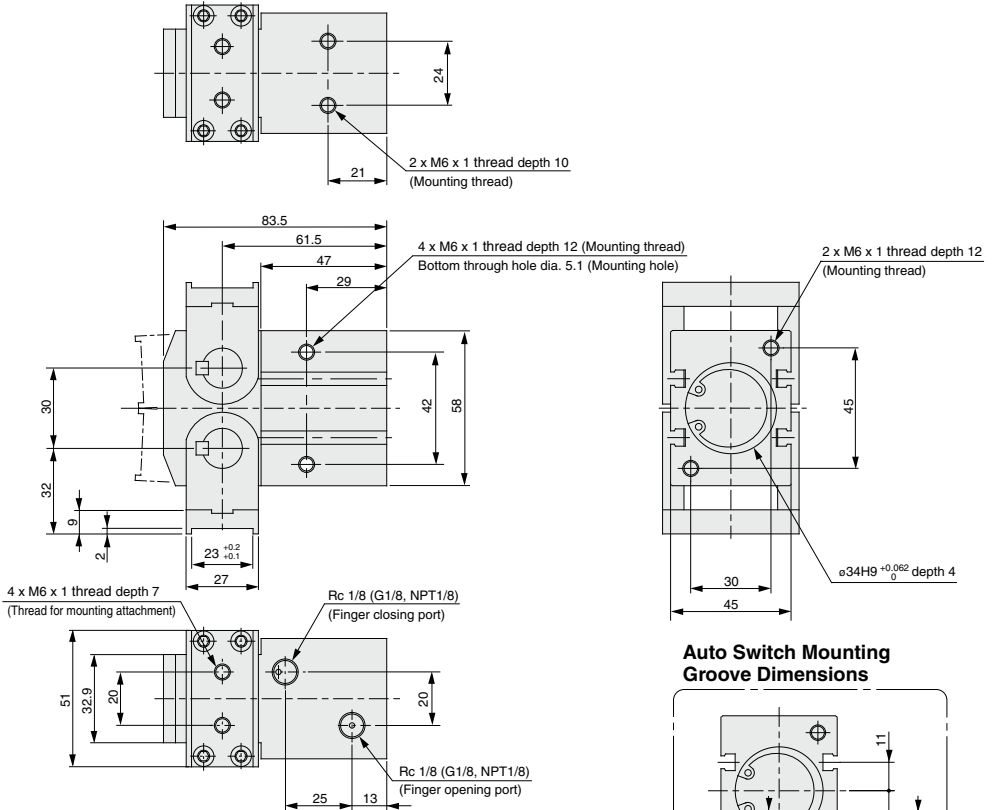

Auto Switch Mounting Groove Dimensions

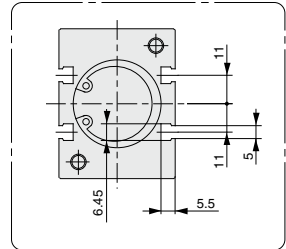

MHW2-32D1

Right angle finger type

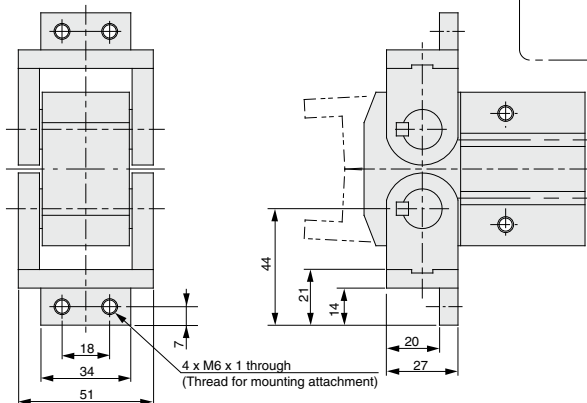

Dimensions

MHW2-40D

Flat finger type (Standard)

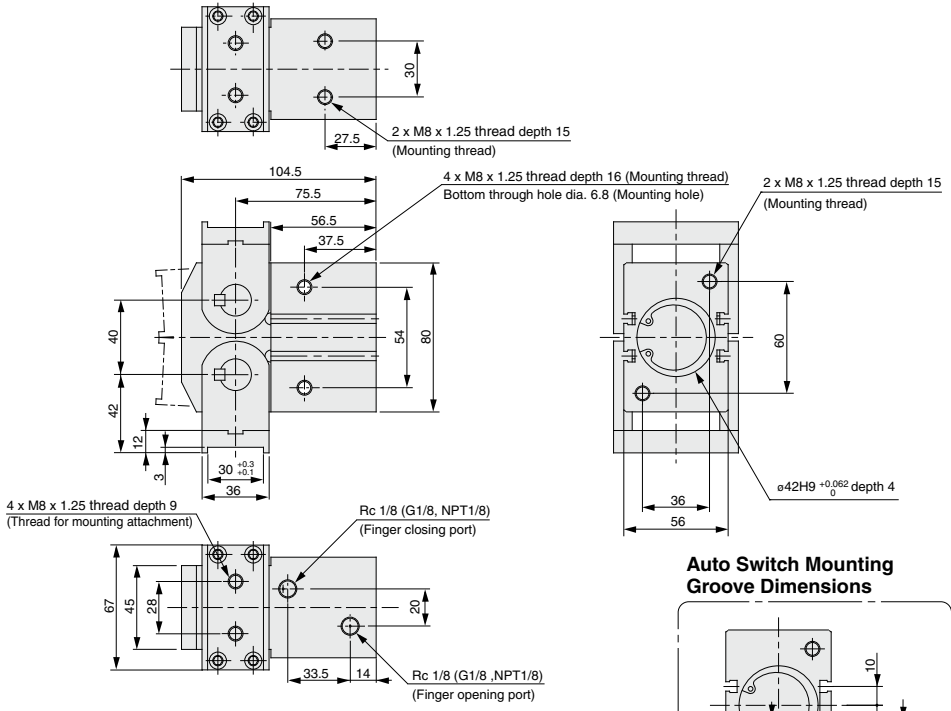

MHW2-40D1

Right angle finger type

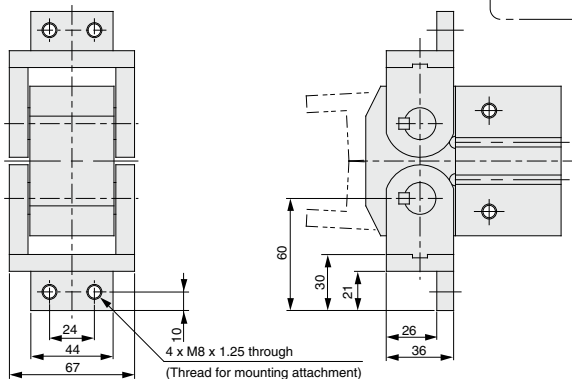

- MHZ
- MHF
- MHL
- MHR
- MHK
- MHS
- MHC
- MHT
- MHY
- MHW
- X□
- MRHQ
- MA
- D-□

MHY2/MHW2 Series

Auto Switch Installation Examples and Mounting Positions

Various auto switch applications are possible through different combinations of auto switch quantities and detecting positions.

Detection when Gripping Exterior of Workpiece

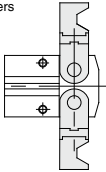
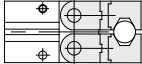
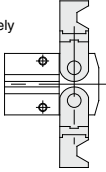
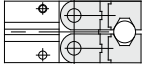
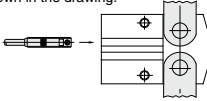
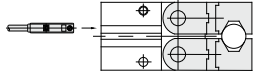
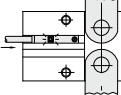
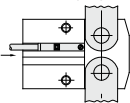
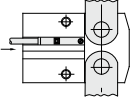
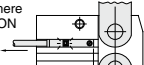
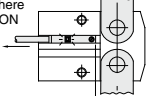
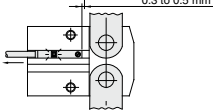
Detection example	1. Confirmation of the fingers in reset position	2. Confirmation of work held
Position to be detected	<p>Position of fingers fully opened</p> 	<p>Position when gripping a workpiece</p> 
Operation of auto switch	<p>Auto Switch turned ON when fingers return. (Light ON)</p>	<p>Auto Switch turned ON when gripping a workpiece. (Light ON)</p>
<p>How to determine auto switch installation position</p> <p>At no pressure or low pressure, connect the auto switch to a power supply, and follow the directions.</p>	<p>Step 1) Completely open the fingers.</p> 	<p>Step 1) Position fingers for gripping a workpiece.</p> 
	<p>Step 2) Insert the auto switch into the switch groove in the direction shown in the drawing.</p> 	<p>Step 2) Insert the auto switch into the switch groove in the direction shown in the drawing.</p> 
	<p>Step 3) Slide the auto switch in the direction of the arrow until the indicator light illuminates.</p> 	<p>Step 3) Slide the auto switch in the direction of the arrow until the indicator light illuminates. Move the switch an additional 0.3 to 0.5 mm in the direction of the arrow and fasten it.</p>
	<p>Step 4) Slide the auto switch further in the direction of the arrow until the indicator light goes out.</p> 	<p>Position where light turns ON</p> 
	<p>Step 5) Move the auto switch in the opposite direction and fasten it at a position 0.3 to 0.5 mm beyond the position where the indicator light illuminates.</p> <p>Position where light turns ON</p>  <p>Position to be secured</p> 	<p>Position to be secured</p>  <p>0.3 to 0.5 mm</p>

MHZ

MHF

MHL

MHR

MHK

MHS

MHC

MHT

MHY

MHW

-X□

MRHQ

MA

D-□

MHY2 Series

Auto Switch Mounting

To set the auto switch, insert the auto switch into the installation groove of the gripper from the direction indicated in the following drawing. After setting the position, tighten the attached auto switch mounting set screw with a flat head watchmaker's screwdriver.

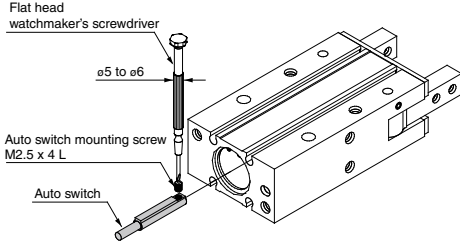

Note) Use a watchmaker's screwdriver with a grip diameter of 5 to 6 mm to tighten the auto switch mounting screw. The tightening torque should be about 0.05 to 0.15 N·m.

* Refer to the page 804 for the details on "Auto Switches Connection and Example".

Auto Switch Hysteresis

Auto switches have hysteresis similar to micro switches. Use the table below as a guide when adjusting auto switch positions, etc.

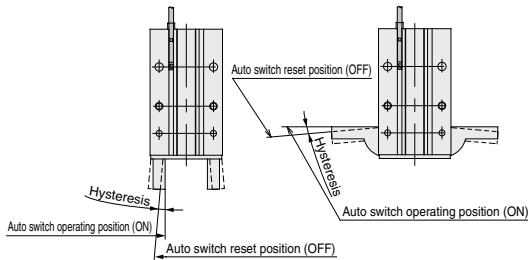

		D-M9□(V) D-M9□W(V)/M9A(V)
MHY2	Finger fully closed	2°
-10D	Finger fully open	4°
MHY2	Finger fully closed	2°
-16D	Finger fully open	3°
MHY2	Finger fully closed	2°
-20D	Finger fully open	3°
MHY2	Finger fully closed	1°
-25D	Finger fully open	2°

Protrusion of Auto Switch from Edge of Body

The projection of an auto switch from the edge of the body is shown in the table below. Use the table as a guideline for mounting.

Note) 2-color indicator type and perpendicular entry type protrude in the direction of the lead wire entry.

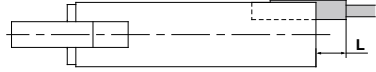

When auto switch D-M9□ is used

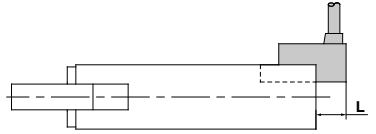

When auto switch D-M9□V is used

Max. Protrusion of Auto Switch from Edge of Body (L)

(mm)

Air gripper model	Auto switch model	Protrusion			
		In-line		Perpendicular	
		D-M9□ D-M9□W	D-M9□V D-M9□WV	D-M9□A	D-M9□AV
MHY2-10D	Open	—	—	—	—
	Closed	3	1	5	3
MHY2-16D	Open	—	—	—	—
	Closed	3	1	5	3
MHY2-20D	Open	—	—	—	—
	Closed	—	—	3	1
MHY2-25D	Open	—	—	—	—
	Closed	—	—	1	—

Auto Switch Mounting

- (1) Insert the auto switch bracket into the installation groove of the gripper as shown below and roughly set it.
- (2) Insert the auto switch into the auto switch bracket installation groove.
- (3) After confirming the detecting position, tighten the set screws (M2.5) attached to the auto switch and set it.
- (4) Be sure to change the detecting position in the state of (2).

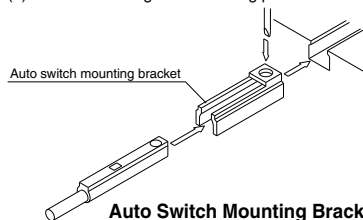

Auto Switch Mounting Bracket: Part No.

Auto switch part no.	Auto switch mounting bracket part no.
D-M9□(V)/M9□W(V)/M9□A(V)	BMG2-012

Note) Use a screwdriver with a grip diameter of 5 to 6 mm to tighten the set screws (M2.5). The tightening torque should be 0.5 to 1 N·m. As a rule, it should be turned about 90° beyond the point at which tightening can be felt.

Auto Switch Hysteresis

Auto switches have hysteresis similar to micro switches. Use the table below as a guide when adjusting auto switch positions, etc.

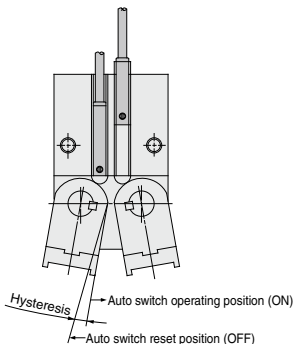

Auto switch model	Auto switch model	D-Y59□/Y69□ D-Y7P(V)/Y7□W(V)
MHW2-20D		4°
MHW2-25D		4°
MHW2-32D		2°
MHW2-40D		2°
MHW2-50D		2°

Auto switch model	Max. hysteresis (Max. value)
MHW2-20D	4°
MHW2-25D	4°
MHW2-32D	2°
MHW2-40D	2°
MHW2-50D	2°

Handling of Mounting Brackets

When auto switch is set on mounting side as shown below, allow at least 2 mm run off space on mounting late since the auto switch is protruded from the gripper edge.

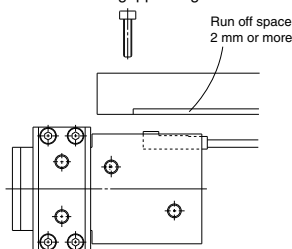

Protrusion of Auto Switch from Edge of Body

The maximum protrusion of an auto switch (when fingers are fully closed) from the edge of the body is shown in the table below. Use the table as a guideline for mounting.

When auto switches
D-M9□/M9□W/Y59^A
D-M9□A
D-Y7□, Y7□W
are used

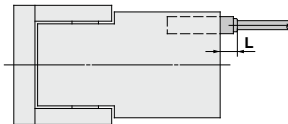

When auto switches
D-M9□V/M9□WV/Y69^A
D-M9□AV
D-Y7□V, Y7□WV
are used

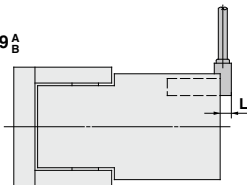

Max. Protrusion of Auto Switch from Edge of Body (L)

Air gripper model	Auto switch Finger position	Protrusion (mm)	
		In-line electrical entry type	Perpendicular electrical entry type
		D-Y59□/Y7P/Y7□W	D-Y69□/Y7PV/Y7□WV
MHW2-20D	Open	—	—
	Closed	7	5
MHW2-25D	Open	—	—
	Closed	7	5
MHW2-32D	Open	—	—
	Closed	4	2
MHW2-40D	Open	—	—
	Closed	3	1
MHW2-50D	Open	—	—
	Closed	1	—

Air gripper model	Auto switch Finger position	Protrusion (mm)			
		In-line electrical entry type		Perpendicular electrical entry type	
		D-M9□/M9□W	M9□A	D-M9□V/M9□WV	M9□AV
MHW2-20D	Open	—	—	—	—
	Closed	7	9	5	7
MHW2-25D	Open	—	—	—	—
	Closed	7	9	5	7
MHW2-32D	Open	—	—	—	—
	Closed	4	6	2	4
MHW2-40D	Open	—	—	—	—
	Closed	3	5	1	3
MHW2-50D	Open	—	—	—	—
	Closed	1	3	—	1

MHZ

MHF

MHL

MHR

MHK

MHS

MHC

MHT

MHY

MHW

-X□

MRHQ

MA

D-□



MHY2/MHW2 Series Specific Product Precautions 1

Be sure to read this before handling the products.

Mounting Air Grippers/MHY2 Series

Possible to mount from 3 directions.

Axial Mounting (Body Tapped)

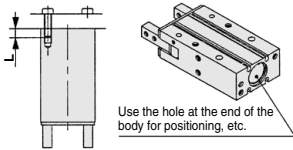

Model	Applicable bolts	Max. tightening torque (N·m)	Max. screw-in depth (Lmm)
MHY2-10D	M3 x 0.5	0.88	6
MHY2-16D	M4 x 0.7	2.1	8
MHY2-20D	M5 x 0.8	4.3	10
MHY2-25D	M6 x 1	7.4	12

Model	Bore(mm)	Hole depth (mm)
MHY2-10D	φ11H9 ^{+0.043} ₀	1.5
MHY2-16D	φ17H9 ^{+0.043} ₀	1.5
MHY2-20D	φ21H9 ^{+0.052} ₀	1.5
MHY2-25D	φ26H9 ^{+0.052} ₀	1.5

Lateral mounting (Body Tapped, Body through-hole)

●Body tapped

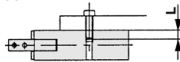

Model	Applicable bolts	Max. tightening torque (N·m)	Max. screw-in depth (Lmm)
MHY2-10D	M3 x 0.5	0.88	6
MHY2-16D	M4 x 0.7	2.1	8
MHY2-20D	M5 x 0.8	4.3	10
MHY2-25D	M6 x 1	7.4	12

●Body through-hole

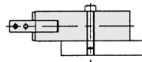

Model	Applicable bolts	Max. tightening torque (N·m)
MHY2-10D	M3 x 0.5	0.88
MHY2-16D	M4 x 0.7	2.1
MHY2-20D	M5 x 0.8	4.3
MHY2-25D	M6 x 1	7.4

Vertical Mounting (Body Tapped)

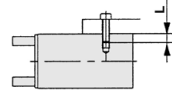

Model	Applicable bolts	Max. tightening torque (N·m)	Max. screw-in depth (Lmm)
MHY2-10D	M3 x 0.5	0.59	4
MHY2-16D	M4 x 0.7	1.3	5
MHY2-20D	M5 x 0.8	3.3	8
MHY2-25D	M6 x 1	5.9	10

How to Mount the Attachment to the Finger

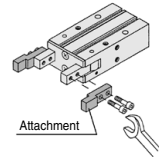

- (1) To mount the attachment to the finger, make sure to use a wrench to support the attachment so as not to apply undue strain on the finger.
- (2) Refer to the table below for the proper tightening torque on the bolt used for securing the attachment to the finger.

Model	Applicable bolts	Max. tightening torque (N·m)
MHY2-10D	M3 x 0.5	0.59
MHY2-16D	M4 x 0.7	1.4
MHY2-25D	M5 x 0.8	2.8

Operating Environment/ MHY2 Series

⚠ Caution

Use caution for the anti-corrosiveness of finger guide section.

Martensitic stainless steel is used for the finger. However, be aware that its anti-corrosion performance is inferior to austenitic stainless steel. In particular, the finger might be rusted in an environment where water droplets are adhered to it due to dew condensation.



MHY2/MHW2 Series Specific Product Precautions 2

Be sure to read this before handling the products.

Mounting Air Grippers/MHW2 Series

Possible to mount from 3 directions.

Axial Mounting (Body Tapped)

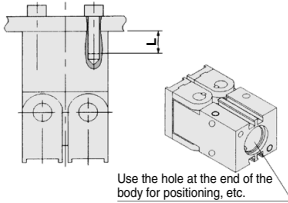

Use the hole at the end of the body for positioning, etc.

Model	Applicable bolts	Max. tightening torque (N·m)	Max. screw-in depth (Lmm)
MHW2-20D	M5 x 0.8	4.3	10
MHW2-25D	M6 x 1	7.4	12
MHW2-32D	M6 x 1	7.4	12
MHW2-40D	M8 x 1.25	17.7	15
MHW2-50D	M10 x 1.5	37.2	20

Model	Bore(mm)	Hole depth (mm)
MHW2-20D	ø21H9 ^{+0.052} ₀	3
MHW2-25D	ø26H9 ^{+0.052} ₀	3
MHW2-32D	ø34H9 ^{+0.052} ₀	4
MHW2-40D	ø42H9 ^{+0.052} ₀	4
MHW2-50D	ø52H9 ^{+0.074} ₀	5

Lateral mounting (Body Tapped, Body through-hole)

●Body tapped

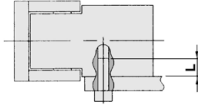

Model	Applicable bolts	Max. tightening torque (N·m)	Max. screw-in depth (Lmm)
MHW2-20D	M5 x 0.8	4.3	10
MHW2-25D	M6 x 1	7.4	12
MHW2-32D	M6 x 1	7.4	12
MHW2-40D	M8 x 1.25	17.7	16
MHW2-50D	M10 x 1.5	37.2	20

●Body through-hole

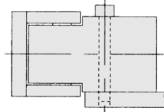

Model	Applicable bolts	Max. tightening torque (N·m)
MHW2-20D	M4 x 0.7	2.1
MHW2-25D	M5 x 0.8	4.3
MHW2-32D	M5 x 0.8	4.3
MHW2-40D	M6 x 1	7.4
MHW2-50D	M8 x 1.25	17.7

Vertical Mounting (Body Tapped)

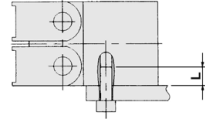

Model	Applicable bolts	Max. tightening torque (N·m)	Max. screw-in depth (Lmm)
MHW2-20D	M5 x 0.8	2.9	7
MHW2-25D	M6 x 1	5.9	10
MHW2-32D	M6 x 1	5.9	10
MHW2-40D	M8 x 1.25	17.7	15
MHW2-50D	M10 x 1.5	37.2	20

How to Mount the Attachment to the Finger

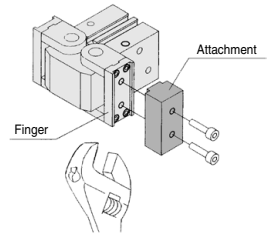

- (1) To mount the attachment to the finger, make sure to use a wrench to support the attachment so as not to apply undue strain on the finger.
- (2) Refer to the table below for the proper tightening torque on the bolt used for securing the attachment to the finger.

Model	Applicable bolts	Max. tightening torque (N·m)
MHW2-20D	M4 x 0.7	1.4
MHW2-25D	M5 x 0.8	2.5
MHW2-32D	M6 x 1	4.1
MHW2-40D	M8 x 1.25	10.6
MHW2-50D	M10 x 1.5	24.5

MHZ

MHF

MHL

MHR

MHK

MHS

MHC

MHT

MHY

MHW

-X□

MRHQ

MA

D-□