

# Air Cylinder

## Series CJ2

ø6, ø10, ø16



### Long life of over 1.5 times (In-house comparison)

The mounting accuracy of the cylinder and the wear resistance of the seals have been improved, thus dramatically increasing the cylinder's life to more than 1.5 times that of the CJ1 Series.

### Compact and lightweight:

The lateral width of the cover has been reduced approximately 10% from the CJ1 Series. In addition to a weight reduction of over 30%, a space-saving configuration has been achieved.



### Improved wear resistance:

The bearing portions of the rod cover and the clevis have been improved in wear resistance to ensure the longevity of the cylinder.

### High speed actuation possible:

Either the rubber bumper or the air cushion can be selected according to the drive speed conditions. Therefore, it can support high speed drives.

- Rubber bumper ..... 50 to 750mm/s (Standard equipment)
- Air cushion ..... 50 to 1000mm/s

### Easy installation:

The installation is simple because a tool can be placed directly over the cover for installation.

### Reduced piston rod deflection:

The clearance between the bushing and the piston rod has been decreased to achieve higher accuracy, thus decreasing the deflection of the piston rod.

### Variations

Series	Action	Rod	Basic	Standard variations				Bore size (mm)	Page
				Built-in magnet	Air cushion	Clean	Copper free		
Standard: CJ2	Double acting	Single rod	●	●	●	●	6 10 16	1.3-2	
		Double rod	●	●	●	●		1.3-13	
	Single acting	Single rod, Spring return/extend	●	●	●	●		1.3-20	
Non-rotating rod: CJ2K	Double acting	Single rod	●	●	●	●	10 16	1.3-30	
	Single acting	Single rod, Spring return/extend	●	●	●	●		1.3-35	
Built-in speed controller: CJ2Z	Double acting	Single rod	●	●	●	●	10 16	1.3-42	
		Double rod	●	●	●	●		1.3-47	
Low friction: CJ2Q	Double acting	Single rod	●	●	●	●	10 16	1.3-52	
Direct mount: CJ2R	Double acting	Single rod	●	●	●	●	10 16	1.3-56	
	Single acting	Single rod, Spring return/extend	●	●	●	●		1.3-61	
Non-rotating rod/ Direct mount: CJ2RK	Double acting	Single rod	●	●	●	●	10 16	1.3-65	
	Single acting	Single rod, Spring return/extend	●	●	●	●		1.3-69	

### Made to Order

Applicable auto switch	Band mounting	Rail mounting
<b>Reed switch</b>	D-C7/C8, D-C73C/C80C	D-A7/A8, D-A7□H/A80H, D-A73C/A80C, D-A79W
<b>Solid state switch</b>	D-H7□, D-H7C D-H7□W, D-H7BAL, D-H7□F	D-F7/J7, D-F7□V, D-J79C D-F7□W/J79W, D-F7□WV, D-F7BAL, D-F7□F, D-F7NTL

Refer to p.5.4-1 for made to order products of series CJ2.

- CJ1
- CJP
- CJ2**
- CM2
- C85
- CG1
- MB
- C95
- CA1
- CS1

# Standard: Double Acting Single Rod

## Series CJ2



ø6, ø10, ø16

### How to Order

**Bore size**

6	6mm
10	10mm
16	16mm

**Standard stroke (mm)**

ø 6	15, 30, 45, 60
ø10	15, 30, 45, 60, 75, 100, 125, 150
ø16	15, 30, 45, 60, 75, 100, 125, 150, 175, 200

**Mounting**

B	Basic
L	Axial foot
F	Front flange
D	Double clevis (Except for ø6)

**Cushion**

—	Rubber bumper
A	Air cushion (Except for ø6)

**Standard** CJ2 L 16 60 A R

**With auto switch** CDJ2 L 16 60 A R C73

**With auto switch (built-in magnet)**

**Auto switch**

—	2
S	1
n	n

**Port location on head cover**

	ø6	ø10/ø16
—	—	Perpendicular 90°
R	In-line	In-line

\* Refer to p.1.3-4 for the configuration.

\* Refer to the table below for selecting applicable auto switches.

\* If requiring a built-in magnet cylinder without an auto switch, refer to the model number example below.

### Applicable Auto Switches/Refer to p.5.3-2 for further information on auto switch.

Style	Special function	Electrical entry	Indicator	Wiring (Output)	Load voltage		Auto switch model**		Lead wire*				Applicable load							
					DC	AC	Band (ø6, ø10, ø16)	Rail (ø10, ø16)	0.5 (-)	3 (L)	5 (Z)	None (N)	IC	PLC						
Reed switch	—	Grommet	Yes	3 wire (NPN)	—	5V	—	C76	A76H	●	●	—	—	IC	—					
								—	A72	A72H	●	●	—	—	—	—				
								—	C73	A73	A73H	●	●	●	—	—	—			
								24V	2 wire	5V, 12V	≤100V	C80	A80	A80H	●	●	—	—	IC	Relay PLC
										12V	—	C73C	A73C	—	●	●	●	—	—	
										5V, 12V	≤24V	C80C	A80C	—	●	●	●	—	—	
Diagnostic indication (2 color)	Grommet	Yes	—	—	—	—	A79W	—	●	●	—	—	—	—						
Solid state switch	—	Grommet	Yes	3 wire (NPN)	5V, 12V	—	H7A1	F7NV	F79	●	●	○	—	IC	Relay PLC					
				3 wire (PNP)			H7A2	F7PV	F7P	●	●	○	—	—						
				2 wire			H7B	F7BV	J79	●	●	○	—	—						
		Connector		2 wire			12V	—	H7C	J79C	—	●	●	●		—	—			
							5V, 12V	24V	3 wire (NPN)	H7NW	F7NWV	F79W	●	●		○	—	IC		
									3 wire (PNP)	H7PW	—	F7PW	●	●		○	—	—		
	Diagnostic indication (2 color)	Grommet	Yes	3 wire (NPN)	H7BW	F9BWV	J79W	●	●	○	—	—								
				3 wire (PNP)	—	—	—	—	—	—	—	—								
				2 wire	12V	—	—	F7BA	—	F7BA	—	●	○	—						
	Water resistant (2 color)	Grommet	Yes	3 wire (NPN)	5V, 12V	—	—	—	F7NT	—	●	○	—	IC						
	With timer			5V, 12V	—	—	—	F7NT	—	●	○	—								
	With diagnostic output (2 color)			4 wire (NPN)	—	—	—	H7NF	—	F79F	●	●	○	—						
Latch with diagnostic output (2 color)	—	—	—	—	—	—	H7LF	—	F7LF	●	●	○	—							

### Part No. of Cylinder with Built-in Magnet

Symbol "-A" (rail mounting) or "-B" (band mounting) should be suffixed to the part No. of the cylinder with auto switch.

Ex.	Rail mounting	CDJ2B10-45-A
	Band mounting	CDJ2B16-60-B

\* Lead wire length 0.5m..... — e.g.) C73C 5m.....Z e.g.) C73CZ  
3m.....L C73CL None.....N C73CN

\* Solid state switches marked with "○" are manufactured upon receipt of order.

\*\* "D-A79W" cannot be mounted on bore size ø10 cylinder with air cushion.

# Standard: Double Acting Single Rod *Series CJ2*



## Specifications

Action	Double acting/Single rod	
Fluid	Air	
Proof pressure	1.05MPa	
Max. operating pressure	0.7MPa	
Min. operating pressure	ø6	0.12MPa
	ø10, ø16	0.06MPa
Ambient and fluid temperature	Without auto switch: -10°C to 70°C, With auto switch: -10°C to 60°C*	
Cushion	Rubber bumper/Air cushion	
Lubrication	Non-lube	
Thread tolerance	JIS class 2	
Stroke tolerance	+1.0 0	
Piston speed	50 to 750mm/s	
Allowable kinetic energy	ø6	0.012J
	ø10	0.035J
	ø16	0.090J

\* No freezing

CJ1

CJP

**CJ2**

CM2

C85

CG1

MB

C95

CA1

CS1

## JIS symbol

Double acting/Single rod

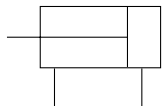

## Standard Stroke

Bore size	Standard stroke (mm)
6	15, 30, 45, 60
10	15, 30, 45, 60, 75, 100, 125, 150
16	15, 30, 45, 60, 75, 100, 125, 150, 175, 200

## Order Made to Order

Refer to p.5.4-1 for made to order products of series CJ2.

## ⚠ Precautions

Be sure to read before handling. Refer to p.0-39 to 0-46 for Safety Instructions and common precautions.

## ⚠ Caution

### Mounting

- During installation, secure the rod cover and tighten by applying an appropriate tightening force to the retaining nut or to the rod cover body. If the head cover is secured or the head cover body is tightened, the cover could rotate, leading to a deviation.
- Tighten the retaining screws to an appropriate tightening torque within the range given below.  
ø6: 2.1 to 2.5Nm, ø10: 5.9 to 6.4Nm, ø16: 10.8 to 11.8Nm
- To remove and install the snap ring for the knuckle pin or the clevis pin, use an appropriate pair of pliers (tool for installing a C type snap ring). In particular, use a pair of ultra-mini pliers such as the Super Tool CSM-07A for removing and installing the snap rings on the ø10 cylinder.
- In the case of auto switch rail mounting style, do not remove the rail that is mounted. Because the retaining screws extend into the cylinder, this could lead to an air leak.

## Minimum Strokes for Auto Switch Mounting

Mounting	Auto switch model	Number of switches	Min. stroke (mm)	
Band mounting (ø6, ø10, ø16)	D-C7 D-C8	2 (same surface)	50	
		2 (different surfaces)	15	
		1	10	
	D-H7□ D-H7□W D-H7BAL D-H7NF	2 (same surface)	60	
		2 (different surfaces)	15	
		1	10	
	D-C73C D-C80C D-H7C	2 (same surface)	65	
		2 (different surfaces)	15	
		1	10	
	Rail mounting (ø10, ø16)	D-H7LF	2 (same surface)	65
			2 (different surfaces)	25
		D-A7/A8 D-A7□H/A80H D-A73C/A80C D-F7 D-J79 D-F7□V D-J79C D-A79W D-F7□W D-J79W D-F7BAL D-F7□WV D-F79F D-F7LF	1	15
2			10	
1			5	
2			5	
1	5			
2	15			
1	10			
2	15			
1	15			

# Series CJ2

## Mounting Accessories/Refer to p.1.3-12 for details.

Mounting		Basic	Axial foot	Front flange	Double clevis*
Standard	Mounting nut	●	●	●	—
	Rod end nut	●	●	●	●
	Clevis pin	—	—	—	●
Option	Single knuckle joint	●	●	●	●
	Double knuckle joint*	●	●	●	●
	T bracket	—	—	—	●

\* Double clevis or double knuckle joint are packaged with pins and rings.

## Mounting Bracket Part No.

Mounting bracket	Bore size (mm)		
	6	10	16
Foot	CJ-L006B	CJ-L010B	CJ-L016B
Flange	CJ-F006B	CJ-F010B	CJ-F016B
T bracket*	—	CJ-T010B	CJ-T016B

\* T bracket is used with double clevis (D)

## Auto Switch Mounting Bracket Part No. (Band mounting)

Bore size (mm)	Bracket part No.	Note
6	BJ2-006	Common use to all of D-C7, C8 and D-H7
10	BJ2-010	
16	BJ2-016	

[A set of stainless steel mounting screws]

Note) A set of stainless steel mounting screws "BBA4" is attached. (A switch mounting band is not attached. Please order the band separately.)  
 "BBA4" screws are used for D-C7/C8/H7.  
 "D-H7BAL" switch is set on the cylinder with the screws above when shipped.  
 Also, when a switch only is shipped, "BBA4" screws are attached.

## Theoretical Force

Refer to the "Double acting cylinder" in Theoretical Force Table 1 of Technical data 3 on p.5.6-7.

## Port Location on Head Cover

Either perpendicular to the cylinder axis or in-line with the cylinder axis is selectable for basic style. (ø6 is available only as in-line style.)

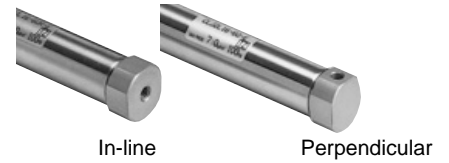

## Weight

(g)

Bore size (mm)		6	10	16
Basic weight*		15	24	55
Additional weight for each 15 of stroke		2	4	6.5
Mounting bracket weight	Axial foot	8	8	20
	Front flange	5	5	15
	Double clevis** (with pins)	—	4	10
Accessory	Single knuckle joint	—	16	22
	Double knuckle joint	—	24	19.5
	T bracket	—	32	50

\* This basic weight includes weights of mounting nut and rod end nut.

\*\* The mounting nut is not attached to the double clevis style, so the mounting nut weight is already reduced.

Calculation example: CJ2L10-45

- Basic weight: 24 (ø10)
- Additional weight: 4/15 stroke
- Cylinder stroke: 45 stroke
- Mounting bracket weight: 8 (Axial foot)
- $24 + 4/15 \times 45 + 8 = 44\text{g}$

## With Air Cushion

**CJ2** | Mounting | Bore size | Stroke | **A** | Port location on head cover

• With air cushion

With covers on both sides equipped with the cushion function, the cylinder absorbs the impact during high-speed operation.



## Clean Series

**10-CJ2** | Mounting | Bore size | Stroke | Port location on head cover

• Clean series

The rod section of actuator is reinforced with the double-seal structure. The air cylinder can be incorporated in the system which directly discharges the external leak from the clean room through the relief port.



### Specifications

Action	Double acting/Single rod	
Bore size	ø6, ø10, ø16	
Max. operating pressure	0.7MPa	
Min. operating pressure	ø6	0.14MPa
	ø10, ø16	0.08MPa
Cushion	Rubber bumper (standard)	
Standard stroke	Same as the standard (Refer to p.1.3-3)	
Auto switch	Possible to be mounted	
Mounting	Basic, Axial foot, Front flange	

### Construction

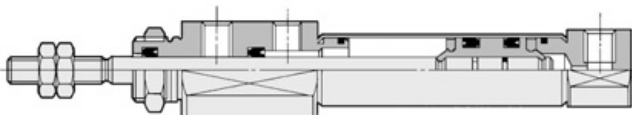

### Specifications

Action	Double acting/Single rod
Lubrication	Non-lube
Bore size	ø10, ø16
Max. operating pressure	0.7MPa
Min. operating pressure	0.1MPa
Piston speed	50 to 1000mm/s
Mounting	Basic, Axial foot, Front flange, Double clevis

### Cushion Mechanism

Bore size (mm)	Effective cushion length (mm)	Allowable kinetic energy (J)
10	9.4	0.07J
16	9.4	0.18J

\* Refer to p.1.3-6 for the construction.

## Copper Free

**20-CJ2** | Mounting | Bore size | Stroke | Port location on head cover

• Copper free

To eliminate influences of copper ions or halogen ions during CRT manufacturing processes, copper and fluorine materials are not used as component parts.



### Specifications

Action	Double acting/Single rod	
Bore size	ø6, ø10, ø16	
Max. operating pressure	0.7MPa	
Min. operating pressure	ø6	0.12MPa
	ø10, ø16	0.06MPa
Cushion	Rubber bumper (standard)	
Standard stroke	Same as the standard (Refer to p.1.3-3)	
Auto switch	Possible to be mounted	
Mounting	Basic, Axial foot, Front flange, Double clevis (Except for ø6)	

### Construction

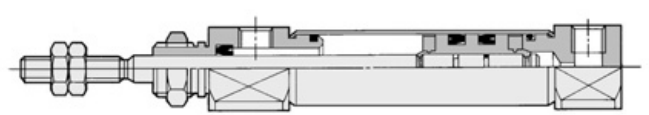

CJ1

CJP

**CJ2**

CM2

C85

CG1

MB

C95

CA1

CS1

# Series CJ2

Construction (The cylinder cannot be disassembled.)

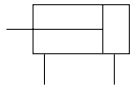

CJ2□6-R

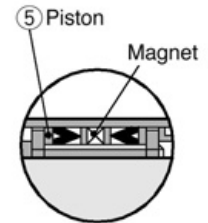
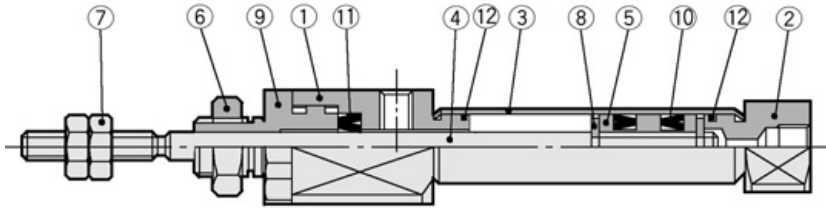

Piston construction in case of auto switches equipped

CJ2□10, CJ2□16

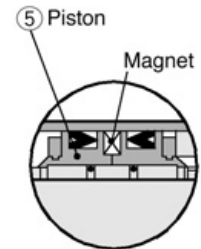
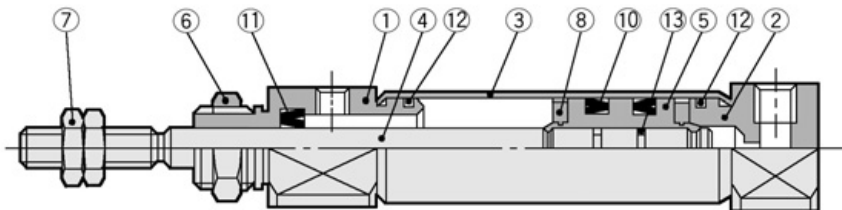

Piston construction in case of auto switches equipped

With air cushion

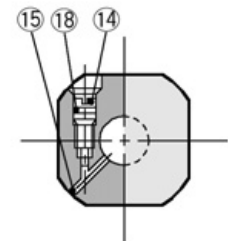
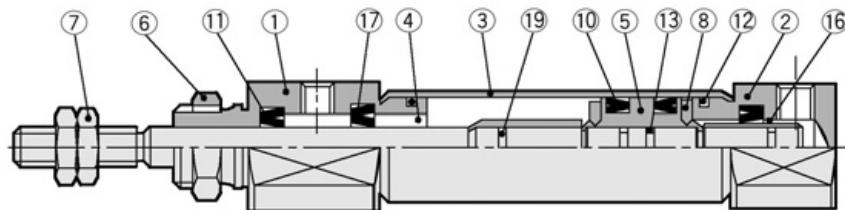

## Component Parts

No.	Description	Material	Note
①	Rod cover	Aluminum alloy	White anodized
②	Head cover	Aluminum alloy	White anodized
③	Cylinder tube	Stainless steel	
④	Piston rod	Stainless steel	
⑤	Piston	Brass	
⑥	Mounting nut	Brass	Nickel plated
⑦	Rod end nut	Rolled steel	Nickel plated
⑧	Bumper	Urethane	
⑨*	Packing retainer	Aluminum alloy	White anodized
⑩	Piston seal	NBR	
⑪	Rod packing	NBR	
⑫	Tube gasket	NBR	
⑬	Piston gasket	NBR	

\* Only for ø6 cylinder

## With Air Cushion

No.	Description	Material	Note
⑭	Cushion needle	Stainless steel	
⑮	Steel ball	Bearing steel	
⑯	Cushion ring	Brass	
⑰	Check seal	NBR	
⑱	Needle seal	NBR	
⑲	Cushion ring gasket	NBR	

# Standard: Double Acting Single Rod *Series CJ2*

Basic (B)



CJ2B Bore size Stroke Port location on head cover

CJ2B6

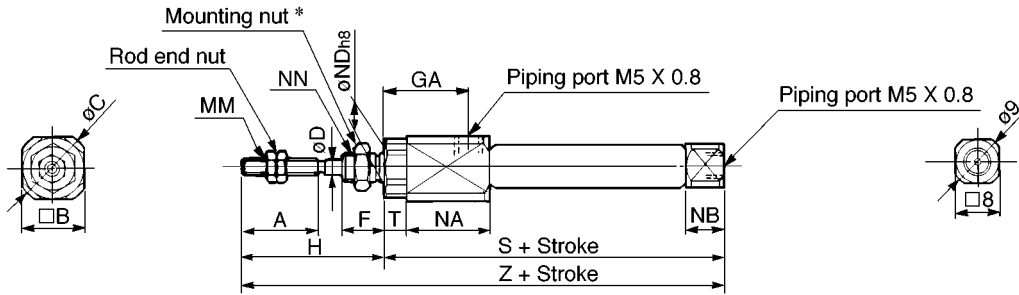

CJ2B10, 16

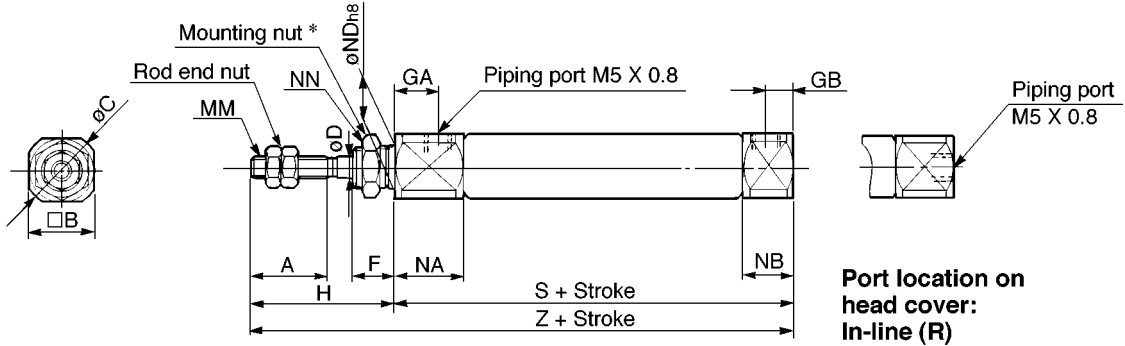

- CJ1
- CJP
- CJ2**
- CM2
- C85
- CG1
- MB
- C95
- CA1
- CS1

With air cushion: CJ2B Bore size Stroke A Port location on head cover

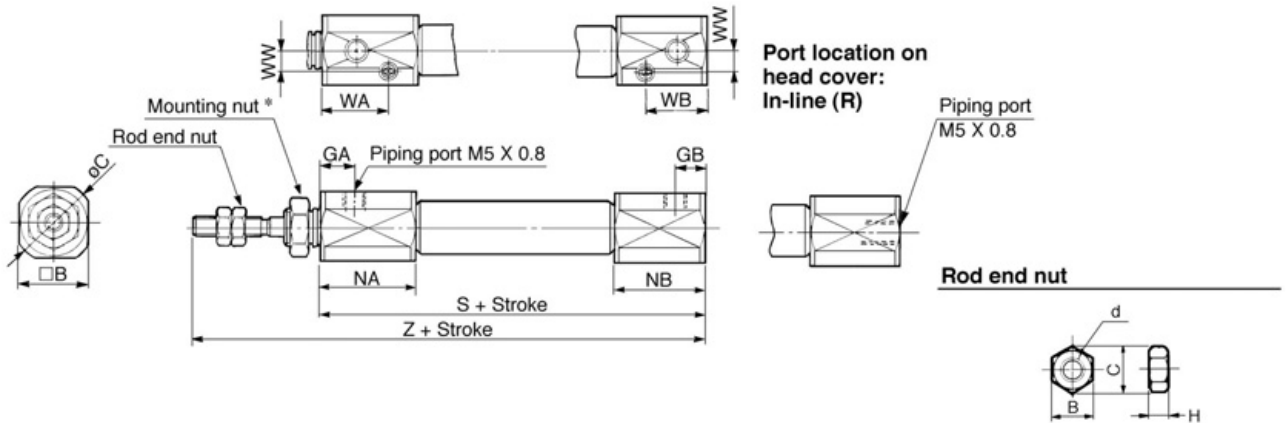

Material: Iron

Part No.	Bore	B	C	d	H
NTJ-006A	6	5.5	6.4	M3 X 0.5	2.4
NTJ-010A	10	7	8.1	M4 X 0.7	3.2
NTJ-015A	16	8	9.2	M5 X 0.8	4

\* Refer to p.1.3-12 for details of the mounting nut.

Bore	A	B	C	D	F	GA	GB	H	MM	NA	NB	NDh8	NN	S	T	Z
6	15	12	14	3	8	14.5	—	28	M3 X 0.5	16	7	6 <sup>0</sup> <sub>-0.018</sub>	M6 X 1.0	49	3	77
10	15	12	14	4	8	8	5	28	M4 X 0.7	12.5	9.5	8 <sup>0</sup> <sub>-0.022</sub>	M8 X 1.0	46	—	74
16	15	18	20	5	8	8	5	28	M5 X 0.8	12.5	9.5	10 <sup>0</sup> <sub>-0.022</sub>	M10 X 1.0	47	—	75

With air cushion/Dimensions not mentioned in the below table are the same as the above table. (mm)

Bore	B	C	GA	GB	NA	NB	WA	WB	WW	S	Z
10	15	17	7.5	6.5	21	20	14.5	13.5	4.5	65	93
16	18	20	7.5	6.5	21	20	14.5	13.5	5.5	66	94



Basic With air cushion  
 CJ2B6.....SCJ26, #1  
 CJ2B10.....SCJ210, #1 SCJ210, #2  
 CJ2B16.....SCJ216, #1 SCJ216, #2

\* The data shows auto switch styles.  
 Please delete the unnecessary parts.

# Series CJ2

Axial Foot (L)



CJ2L Bore size Stroke Port location on head cover

## CJ2L6

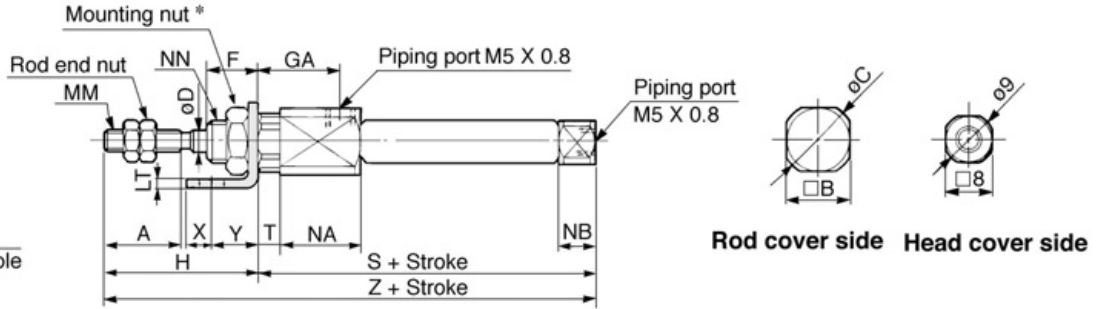
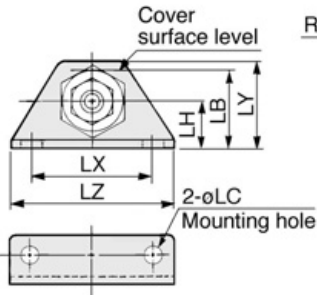

## CJ2L10, 16

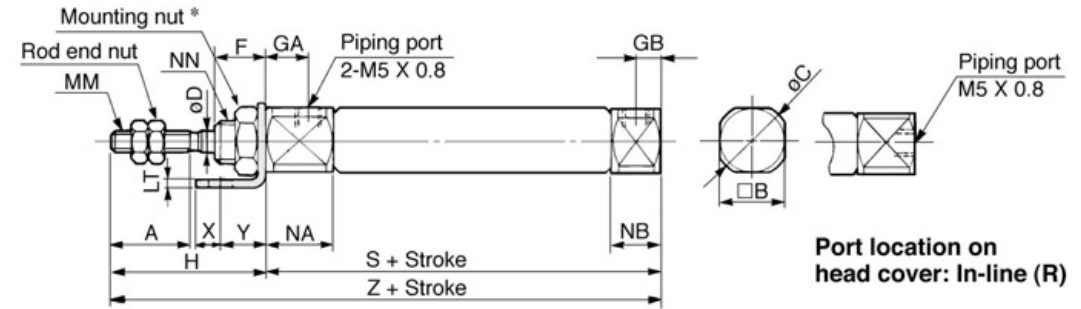
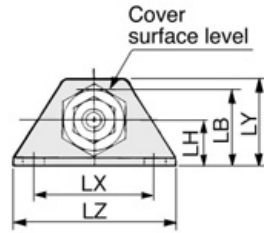

With air cushion: CJ2L Bore size Stroke A Port location on head cover

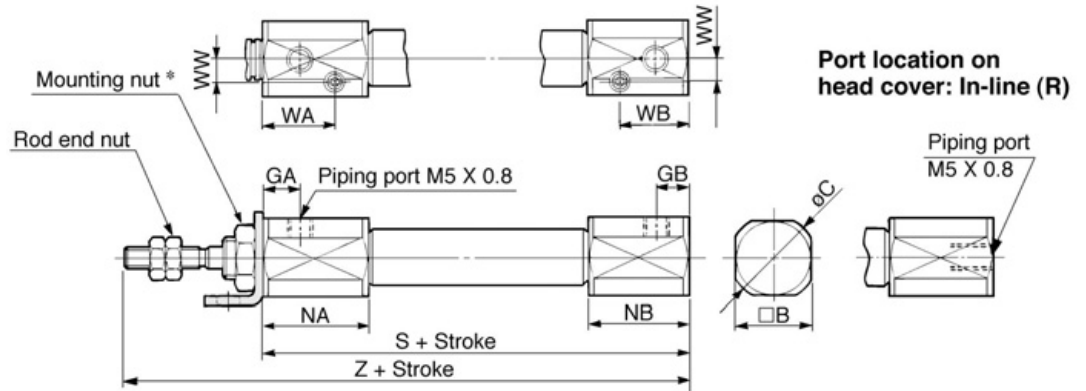
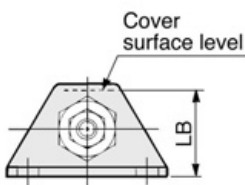

### Rod end nut

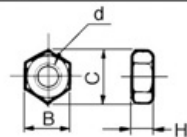

Material: Iron

Part No.	Bore	B	C	d	H
NTJ-006A	6	5.5	6.4	M3 X 0.5	2.4
NTJ-010A	10	7	8.1	M4 X 0.7	3.2
NTJ-015A	16	8	9.2	M5 X 0.8	4

\* Refer to p.1.3-12 for details of the mounting nut.

Bore	A	B	C	D	F	GA	GB	H	LB	LC	LH	LT	LX	LY	LZ	MM	NA	NB	NN	S	T	X	Y	Z
6	15	12	14	3	8	14.5	—	28	15	4.5	9	1.6	24	16.5	32	M3 X 0.5	16	7	M6 X 1.0	49	3	5	7	77
10	15	12	14	4	8	8	5	28	15	4.5	9	1.6	24	16.5	32	M4 X 0.7	12.5	9.5	M8 X 1.0	46	—	5	7	74
16	15	18	20	5	8	8	5	28	23	5.5	14	2.3	33	25	42	M5 X 0.8	12.5	9.5	M10 X 1.0	47	—	6	9	75

With air cushion/Dimensions not mentioned in the below table are the same as the above table. (mm)

Bore	B	C	GA	GB	LB	NA	NB	WA	WB	WW	S	Z
10	15	17	7.5	6.5	16.5	21	20	14.5	13.5	4.5	65	93
16	18	20	7.5	6.5	23	21	20	14.5	13.5	5.5	66	94



Basic	With foot	With air cushion
CJ2L6.....SCJ26, #1	SCJ26, #1, #3	—
CJ2L10.....SCJ210, #1	SCJ210, #1, #3	SCJ210, #2, #3
CJ2L16.....SCJ216, #1	SCJ216, #1, #3	SCJ216, #2, #3

\* The data shows auto switch styles.

Please delete the unnecessary parts.



# Standard: Double Acting Single Rod *Series CJ2*

Front Flange (F)



CJ2F Bore size Stroke Port location on head cover

## CJ2F6

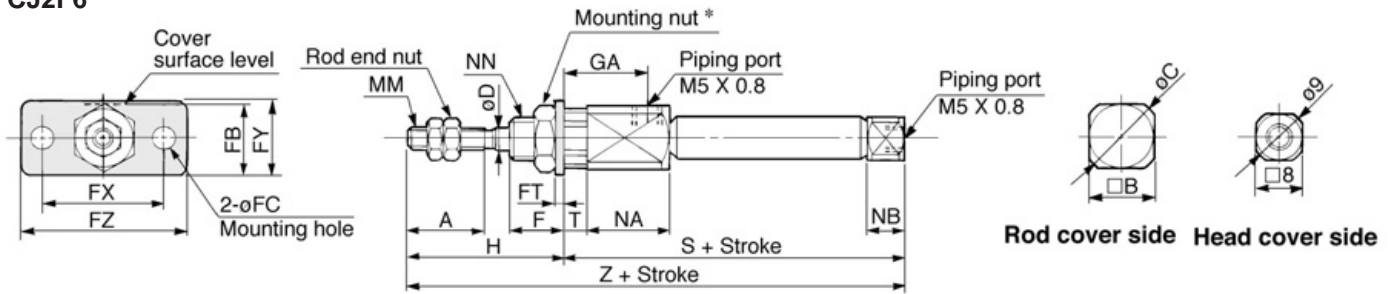

## CJ2F10, 16

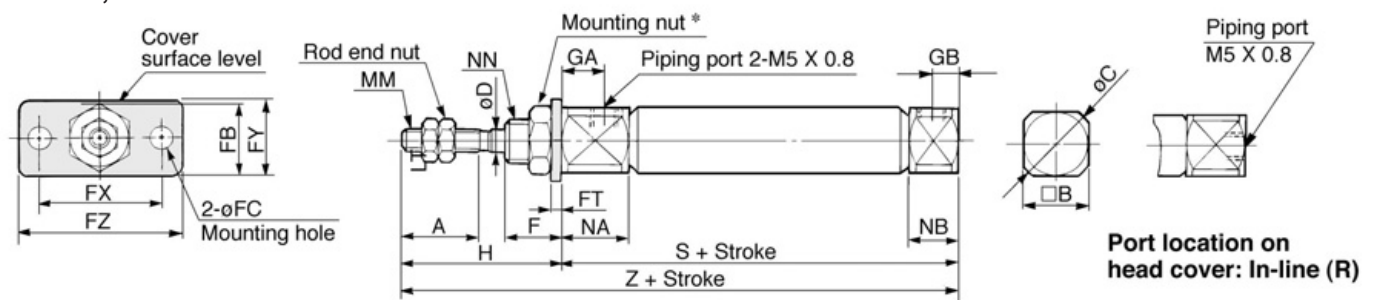

With air cushion: CJ2F Bore size Stroke A Port location on head cover

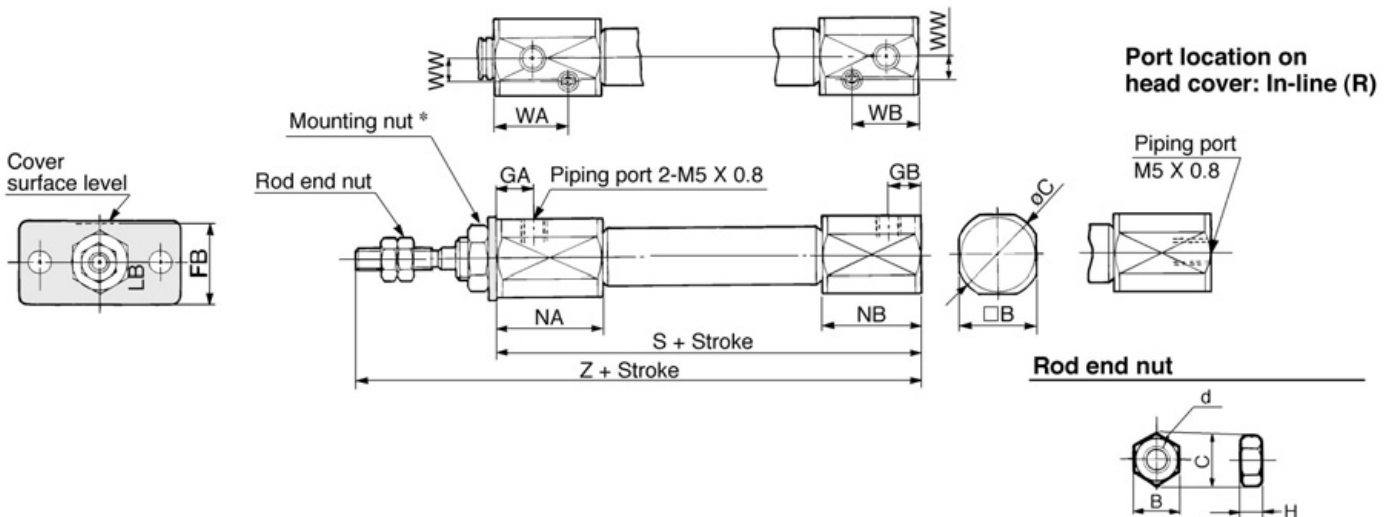

Material: Iron

Part No.	Bore	B	C	d	H
NTJ-006A	6	5.5	6.4	M3 X 0.5	2.4
NTJ-010A	10	7	8.1	M4 X 0.7	3.2
NTJ-015A	16	8	9.2	M5 X 0.8	4

\* Refer to p.1.3-12 for details of the mounting nut.

Bore	A	B	C	D	F	FB	FC	FT	FX	FY	FZ	GA	GB	H	MM	NA	NB	NN	S	T	Z
6	15	12	14	3	8	13	4.5	1.6	24	14	32	14.5	—	28	M3 X 0.5	16	7	M6 X 1.0	49	3	77
10	15	12	14	4	8	13	4.5	1.6	24	14	32	8	5	28	M4 X 0.7	12.5	9.5	M8 X 1.0	46	—	74
16	15	18	20	5	8	19	5.5	2.3	33	20	42	8	5	28	M5 X 0.8	12.5	9.5	M10 X 1.0	47	—	75

With air cushion/Dimensions not mentioned in the below table are the same as the above table. (mm)

Bore	B	C	FB	GA	GB	NA	NB	WA	WB	WW	S	Z
10	15	17	14.5	7.5	6.5	21	20	14.5	13.5	4.5	65	93
16	18	20	19	7.5	6.5	21	20	14.5	13.5	5.5	66	94



Basic	Font flange	With air cushion
CJ2F6.....SCJ26, #1	SCJ26, #1, #4	—
CJ2F10.....SCJ210, #1	SCJ210, #1, #4	SCJ210, #2, #4
CJ2F16.....SCJ216, #1	SCJ216, #1, #4	SCJ216, #2, #4

\* The data shows auto switch styles.

Please delete the unnecessary parts.

# Series CJ2

## Double Clevis (D)



CJ2D Bore size Stroke

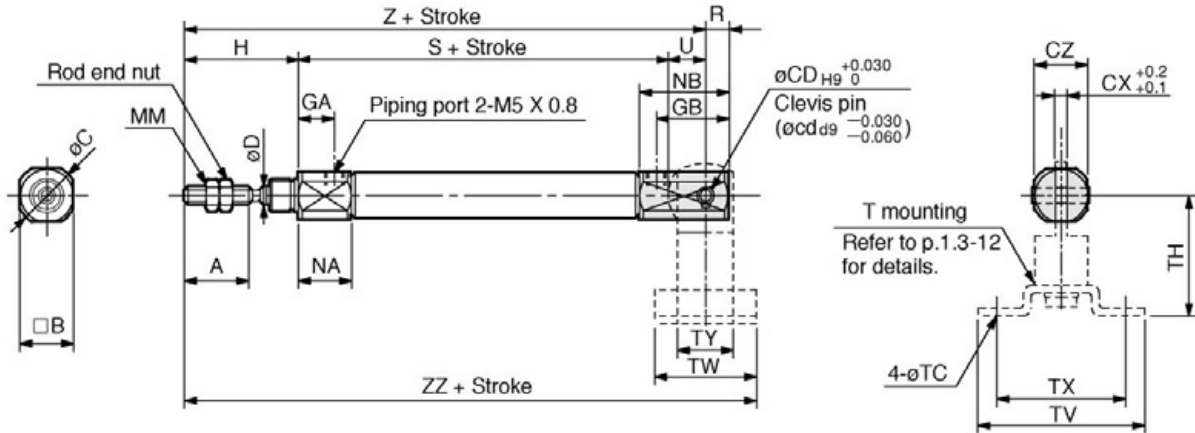

\* Clevis pins and set rings are attached.

With air cushion: CJ2D Bore size Stroke A

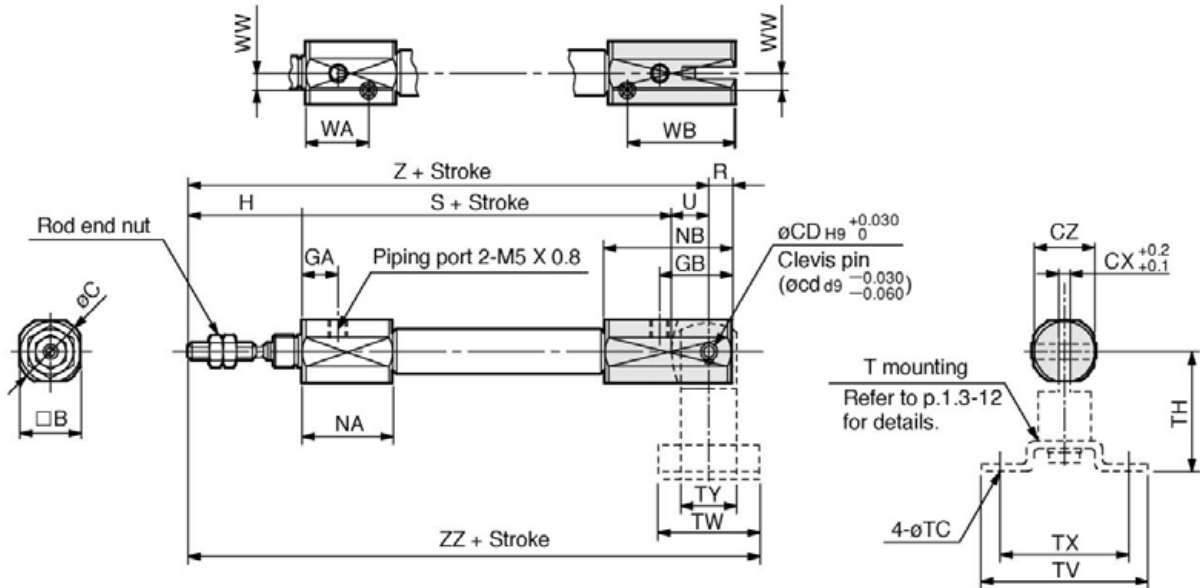

\* Clevis pins and set rings are attached.

### Rod end nut

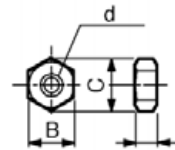

Material: Iron

Part No.	Bore	B	C	d	H
NTJ-010A	10	7	8.1	M4 X 0.7	3.2
NTJ-015A	16	8	9.2	M5 X 0.8	4

Bore	A	B	C	CD (cd)	CX	CZ	D	GA	GB	H	MM	NA	NB	R	S	U	Z	ZZ
10	15	12	14	3.3	3.2	12	4	8	18	28	M4 X 0.7	12.5	22.5	5	46	8	82	93
16	15	18	20	5	6.5	18	5	8	23	28	M5 X 0.8	12.5	27.5	8	47	10	85	99

### T mounting dimensions (mm)

Bore	TC	TH	TV	TW	TX	TY
10	4.5	29	40	22	32	12
16	5.5	35	48	28	38	16

With air cushion/Dimensions not mentioned in the below table are the same as the above table. (mm)

Bore	B	C	CZ	GA	GB	NA	NB	S	WA	WB	WW	Z	ZZ
10	15	17	15	7.5	19.5	21	33	65	14.5	26.5	4.5	101	112
16	18	20	18	7.5	24.5	21	38	66	14.5	31.5	5.5	104	118



Double clevis

CJ2D10 ..... SCJ210, #5

CJ2D16 ..... SCJ216, #5

\* The data shows auto switch styles.

Please delete the unnecessary parts.

## Auto Switch Mounting Position

### Reed Switch <Band mounting> D-C7/C8

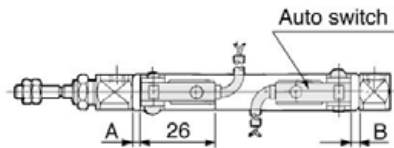
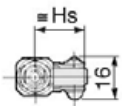

### D-C73C/C80C

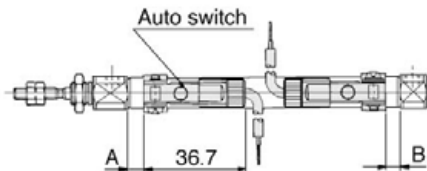
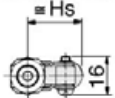

### Solid State Switch <Band mounting>

( ) : D-H7LF  
D-H7□  
D-H7□W  
D-H7BAL  
D-H7□F

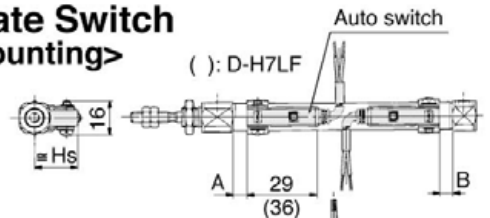

### D-H7C

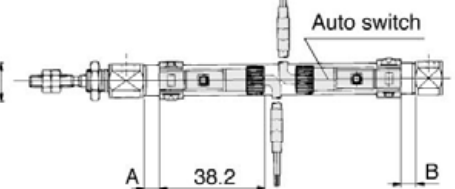
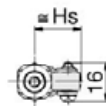

### <Rail mounting>

#### D-A7/A8

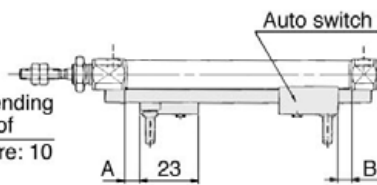
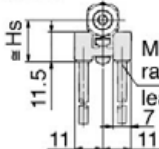

#### D-A7□H/A80H

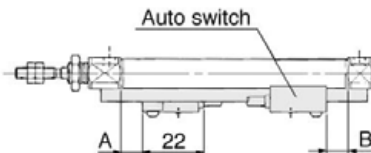
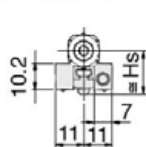

#### D-A73C/A80C

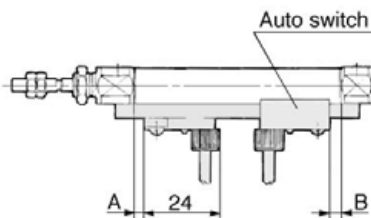
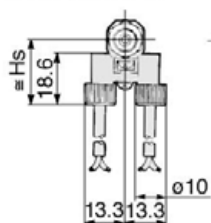

#### D-A79W

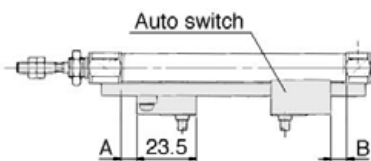
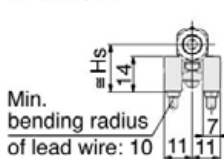

### <Rail mounting>

#### D-F7/J7 D-F7□W/J79W D-F7□F/F7BAL

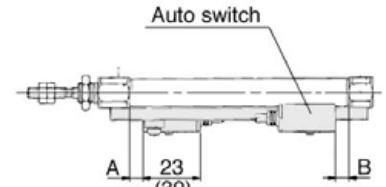
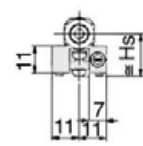

#### D-F7□V/F7□WV

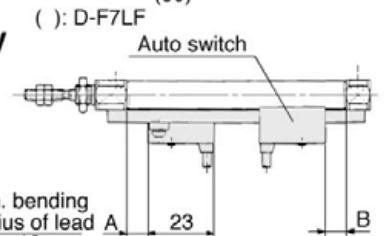
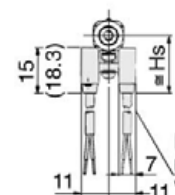

#### D-J79C

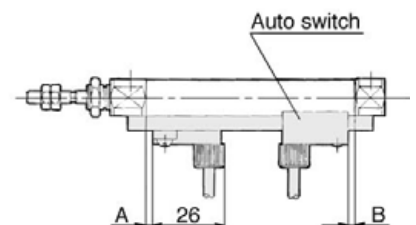
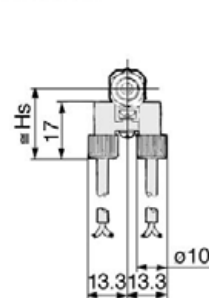

## Auto Switch Mounting Position

Auto switch model	D-C7 D-C8 D-C73C D-C80C		D-H7□ D-H7C		D-H7□W D-H7BAL D-H7□F		D-A7/A8		D-A7□H/A80H D-A73C/A80C D-F7/J7 D-F7□V D-J79C		D-F7BAL D-F7□W D-F7□F D-J79W D-F7□WV		D-A79W	
	A	B	A	B	A	B	A	B	A	B	A	B	A	B
Bore 6	2 (8.5)	2 (0.5)	1 (7.5)	1 (0)	—	—	—	—	—	—	—	—	—	—
Bore 10	2.5	2.5	1.5	1.5	0	0	3	3	3.5	3.5	7.5	7.5	0.5	0.5
Bore 16	3	3	2	2	0.5	0.5	3.5	3.5	4	4	8	8	1	1

## Auto Switch Mounting Height

Auto switch model	D-C7/C8 D-H7□/H7□W D-H7□F D-H7BAL	D-C73C D-C80C	D-H7C	D-A7 D-A8	D-A7□H/A80H D-F7/J7 D-F7□W/J79W D-F7BAL/F7□F	D-A73C D-A80C	D-F7□V D-F7□WV	D-J79C	D-A79W
Bore	Hs	Hs	Hs	Hs	Hs	Hs	Hs	Hs	Hs
Bore 6	15	17.5	18	—	—	—	—	—	—
Bore 10	17	19.5	20	16.5	17.5	23.5	20	23	19
Bore 16	20.5	23	23.5	19.5	20.5	26.5	23	26	22

\* ( ) in the table: In case of double rod style, series CJ2W.

CJ1

CJP

**CJ2**

CM2

C85

CG1

MB

C95

CA1

CS1

# Series CJ2



## Accessory Dimensions

(mm)

### Single knuckle joint

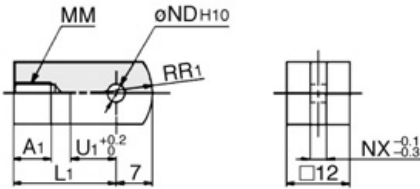

Material: Rolled steel

Part No.	Bore	A1	L1	MM	ND <sup>H10</sup>	NX	R1	U1
I-J010B	10	8	21	M4 X 0.7	33 <sup>+0.048</sup> <sub>0</sub>	3.1	8	9
I-J016B	16	8	25	M5 X 0.8	5 <sup>+0.048</sup> <sub>0</sub>	6.4	12	14

### Clevis pin

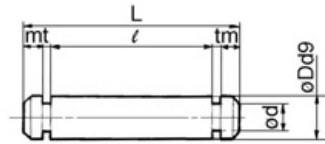

Material: Stainless steel

Part No.	Bore	Dd9	d	L	l	m	t	Set ring
CD-J010	10	33 <sup>-0.030</sup> <sub>-0.060</sub>	3	15.2	12.2	1.2	0.3	C 3.2
CD-Z015	16	5 <sup>-0.030</sup> <sub>-0.060</sub>	4.8	22.7	18.3	1.5	0.7	C 5
CD-JA010*	10	33 <sup>-0.030</sup> <sub>-0.060</sub>	3	18.2	15.2	1.2	0.3	C 3.2

\* For ø10 double clevis style, with air cushion and built-in speed controller

### Knuckle pin

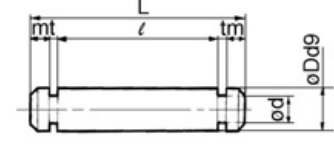

Material: Stainless steel

Part No.	Bore	Dd9	d	L	l	m	t	Set ring
IY-J010	10	33 <sup>-0.030</sup> <sub>-0.060</sub>	3	16.2	12.2	1.7	0.3	C 3.2
IY-J015	16	5 <sup>-0.030</sup> <sub>-0.060</sub>	4.8	16.6	12.2	1.5	0.7	C 5

### Double knuckle joint

\* Knuckle pins and set rings are attached.

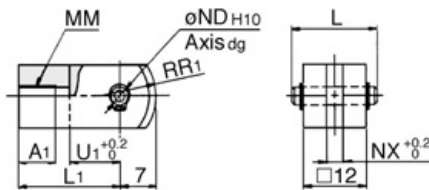

Material: Rolled steel

Part No.	Bore	A1	L	L1	MM
Y-J010B	10	8	16.2	21	M4 X 0.7
Y-J016B	16	11	16.6	21	M5 X 0.8

Part No.	ND <sup>d9</sup>	ND <sup>H10</sup>	NX	R1	U1
Y-J010B	33 <sup>-0.030</sup> <sub>-0.060</sub>	33 <sup>+0.048</sup> <sub>0</sub>	3.2	8	10
Y-J016B	5 <sup>-0.030</sup> <sub>-0.060</sub>	5 <sup>+0.048</sup> <sub>0</sub>	6.5	12	10

### Mounting nut

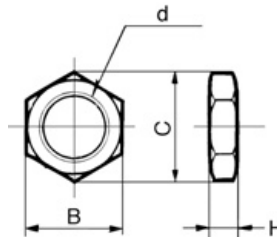

Material: Brass

Part No.	Bore	B	C	d	H
SNJ-006B	6	8	9.2	M6 X 1.0	4
SNJ-010B	10	11	12.7	M8 X 1.0	4
SNJ-016B	16	14	16.2	M10 X 1.0	4
SNKJ-016B*	16	17	19.6	M12 X 1.0	4

\* For ø16 non-rotating style.  
(Use SNJ-016B for ø10 non-rotating style.)

### Rod end nut

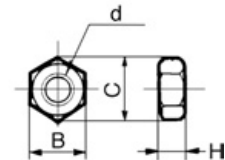

Material: Iron

Part No.	Bore	B	C	d	H
NTJ-006A	6	5.5	6.4	M3 X 0.5	2.4
NTJ-010A	10	7	8.1	M4 X 0.7	3.2
NTJ-015A	16	8	9.2	M5 X 0.8	4

### T bracket

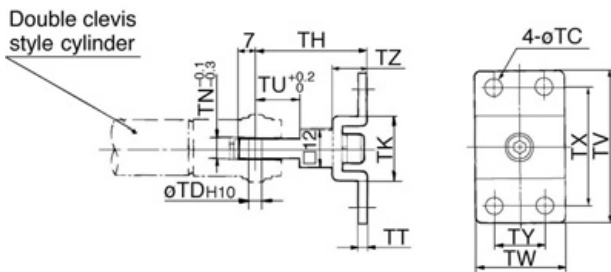

Part No.	Bore	TC	TD <sup>H10</sup>	TH	TK	TN	TT	TU	TV	TW	TX	TY	TZ
CJ-T010B	10	4.5	3.3 <sup>+0.048</sup> <sub>0</sub>	29	18	3.1	2	9	40	22	32	12	8
CJ-T016B	16	5.5	5 <sup>+0.048</sup> <sub>0</sub>	35	20	6.4	2.3	14	48	28	38	16	10

### Rod end cap

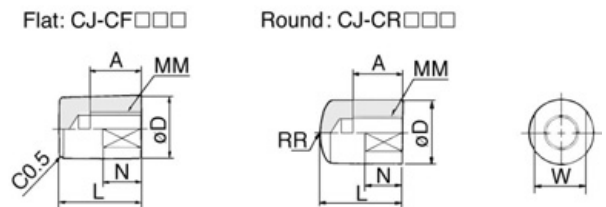

Material: Iron

Part No.		Bore	A	D	L	MM	N	R	W
Flat	Round								
CJ-CF006	CJ-CR006	6	6	8	11	M3 X 0.5	5	8	6
CJ-CF010	CJ-CR010	10	8	10	13	M4 X 0.7	6	10	8
CJ-CF016	CJ-CR016	16	10	12	15	M5 X 0.8	7	12	10



Accessory: SCJ2 [Bore size] #11

# Standard: Double Acting Double Rod

# Series CJ2W



ø6, ø10, ø16

## How to Order

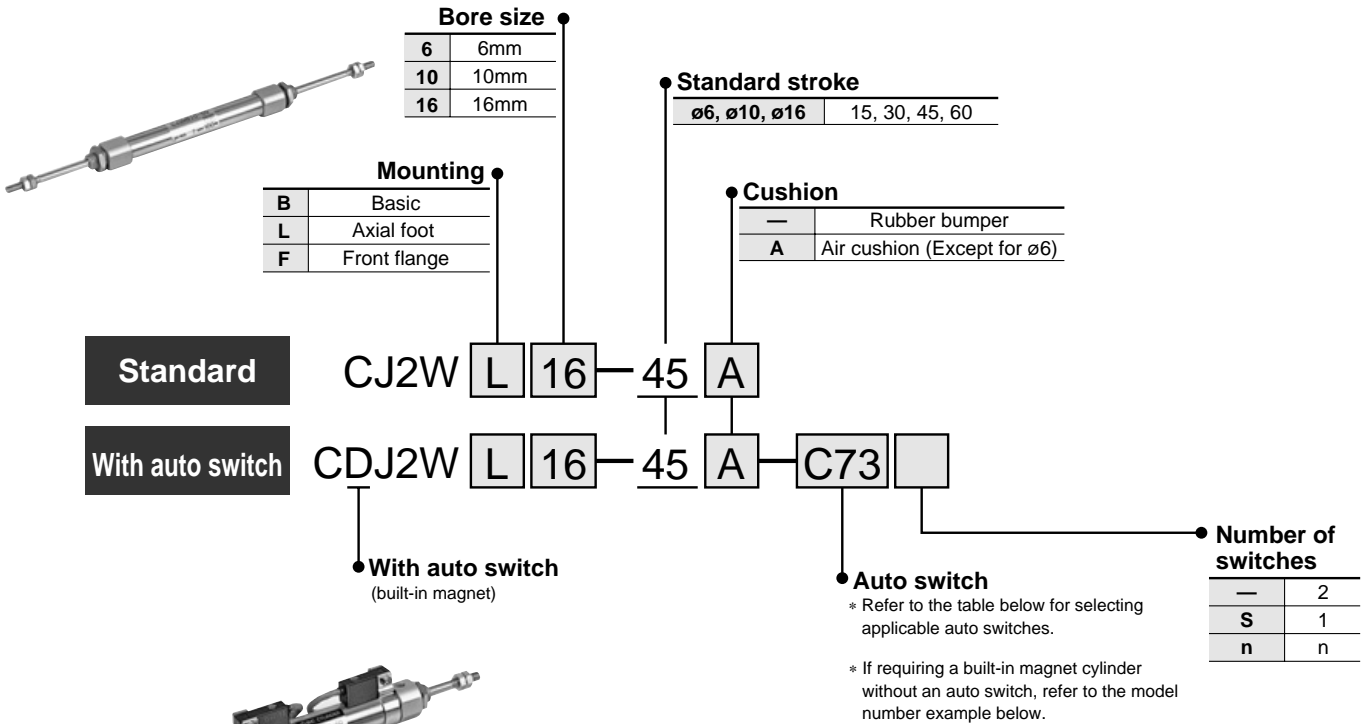

- CJ1
- CJP
- CJ2**
- CM2
- C85
- CG1
- MB
- C95
- CA1
- CS1

### Applicable Auto Switches/Refer to p.5.3-2 for further information on auto switch.

Style	Special function	Electrical entry	Indicator	Wiring (Output)	Load voltage		Auto switch model**		Lead wire*				Applicable load				
					DC	AC	Band (ø6, ø10, ø16)	Rail (ø10, ø16) Perp. In-line	0.5 (-)	3 (L)	5 (Z)	None (N)					
Reed switch	—	Grommet	Yes	3 wire (NPN)	—	5V	—	C76	—	A76H	●	●	—	—	IC	Relay PLC	
				2 wire	—	—	200V	—	A72	A72H	●	●	—	—	—		—
					12V	100V	C73	A73	A73H	●	●	●	—	—	—		
					5V, 12V	≤100V	C80	A80	A80H	●	●	—	—	—	—		
					12V	—	C73C	A73C	—	●	●	●	●	—	—		
				5V, 12V	≤24V	C80C	A80C	—	●	●	●	●	—	—			
Diagnostic indication (2 color)	Grommet	Yes	—	—	—	A79W	—	—	●	●	—	—	—				
Solid state switch	—	Grommet	Yes	3 wire (NPN)	5V, 12V	—	H7A1	F7NV	F79	●	●	○	—	IC	Relay PLC		
				3 wire (PNP)	—	—	H7A2	F7PV	F7P	●	●	○	—				
		Connector	2 wire	12V	—	H7B	F7BV	J79	●	●	○	—					
			2 wire	—	H7C	J79C	—	●	●	●	●	—					
	Diagnostic indication (2 color)	Grommet	Yes	3 wire (NPN)	5V, 12V	—	H7NW	F7NWV	F79W	●	●	○	—	IC			
				3 wire (PNP)	—	—	H7PW	—	F7PW	●	●	○	—				
				2 wire	12V	—	H7BW	F7BWV	J79W	●	●	○	—				
				2 wire	12V	—	H7BA	—	F7BA	—	●	○	—				
				3 wire (NPN)	5V, 12V	—	—	—	F7NT	—	●	○	—				
				4 wire (NPN)	—	—	H7NF	—	F79F	●	●	○	—				
—	—	—	H7LF	—	F7LF	●	●	○	—								

### Part No. of Cylinder with Built-in Magnet

Symbol "-A" (rail mounting) or "-B" (band mounting) should be suffixed to the part No. of the cylinder with auto switch.

Ex.	Rail mounting	CDJ2WB16-60-A
	Band mounting	CDJ2WB10-45-B

\* Lead wire length 0.5m..... e.g.) C73C 5m.....Z e.g.) C73CZ  
3m.....L C73CL None.....N C73CN

\* Solid state switches marked with "○" are manufactured upon receipt of order.

\*\* "D-A79W" cannot be mounted on bore size ø10 cylinder with air cushion.

\*\* "D-H7□W", "D-H7BA" and "D-H7□F" cannot be mounted on bore size ø6 cylinder.

# Series CJ2W

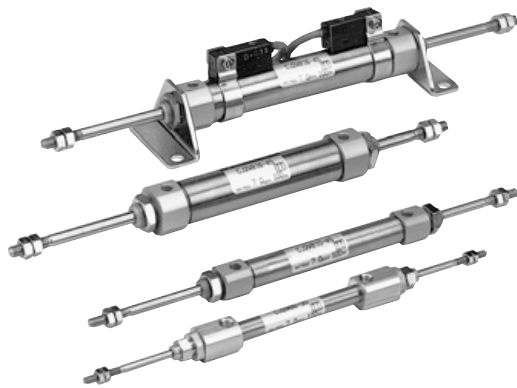

## Specifications

Action	Double acting/Double rod	
Fluid	Air	
Proof pressure	1.05MPa	
Max. operating pressure	0.7MPa	
Min. operating pressure	ø6	0.15MPa
	ø10, ø16	0.1MPa
Ambient and fluid temperature	Without auto switch: -10°C to 70°C, With auto switch: -10°C to 60°C*	
Cushion	Rubber bumper/Air cushion	
Lubrication	Non-lube	
Thread tolerance	JIS class 2	
Stroke tolerance	+1.0 0	
Piston speed	50 to 750mm/s	
Allowable kinetic energy	ø6	0.012J
	ø10	0.035J
	ø16	0.090J

\* No freezing

## JIS Symbol

Double acting/Double rod

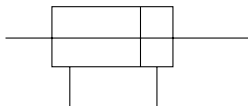

**Order Made** Made to Order

Refer to p.5.4-1 for made to order products of series CJ2W.

## ⚠ Precautions

Be sure to read before handling. Refer to p.0-39 to 0-46 for Safety Instructions and common precautions.

## ⚠ Caution

### Mounting

- During installation, secure the rod cover and tighten by applying an appropriate tightening force to the retaining nut or to the rod cover body. If the head cover is secured or the head cover body is tightened, the cover could rotate, leading to a deviation.
- Tighten the retaining screws to an appropriate tightening torque within the range given below.  
ø6: 2.1 to 2.5Nm, ø10: 5.9 to 6.4Nm, ø16: 10.8 to 11.8Nm
- To remove and install the snap ring for the knuckle pin or the clevis pin, use an appropriate pair of pliers (tool for installing a C type snap ring). In particular, use a pair of ultra-mini pliers such as the Super Tool CSM-07A for removing and installing the snap rings on the ø10 cylinder.
- In the case of auto switch rail mounting, do not remove the rail that is mounted. Because the retaining screws extend into the cylinder, this could lead to an air leak.

## Standard Stroke

(mm)

Bore size	Standard stroke
6, 10, 16	15, 30, 45, 60

## Minimum Strokes for Auto Switch Mounting

Mounting	Auto switch model	Number of switches	Min. stroke (mm)	
Band mounting (ø6) (ø10) (ø16)	D-C7 D-C8	2 (same surface)	50	
		2 (different surfaces)	15	
		1	10	
	D-H7□ D-H7□W <sup>(1)</sup> D-H7BAL <sup>(1)</sup> D-H7NF <sup>(1)</sup>	2 (same surface)	60	
		2 (different surfaces)	15	
		1	10	
	D-C73C D-C80C D-H7C	2 (same surface)	65	
		2 (different surfaces)	15	
		1	10	
	Rail mounting (ø10) (ø16)	D-H7LF <sup>(1)</sup>	2 (same surface)	65
			2 (different surfaces)	25
			1	15
D-A7/A8 D-A7□H/A80H D-A73C/A80C		2	10	
		1	5	
		D-F7 D-J79 D-F7□V D-J79C	2	5
1	5			
D-A79W D-F7□W D-J79W D-F7BAL D-F7□WV D-F79F	2		15	
	1	10		
	D-F7LF	2	15	
1		15		

Note 1) Cannot be mounted on ø6 cylinder.

# Standard: Double Acting Double Rod *Series CJ2W*

## Mounting Accessories/Refer to p.1.3-12 details.

Mounting		Basic	Foot	Flange
Standard	Mounting nut	●	●	●
	Rod end nut	●	●	●
Option	Single knuckle joint	●	●	●
	Double knuckle joint*	●	●	●

\* Double clevis or double knuckle joint is packaged with knuckle pins and set rings.

## Mounting Bracket Part No.

Mounting bracket	Bore size (mm)		
	6	10	16
Foot	CJ-L006B	CJ-L010B	CJ-L016B
Flange	CJ-F006B	CJ-F010B	CJ-F016B

## Auto Switch Mounting Bracket Part No. (Band mounting)

Bore size (mm)	Bracket part No.	Note
6	BJ2-006	Common use to all of D-C7, C8 and D-H7
10	BJ2-010	
16	BJ2-016	

Note) A set of stainless steel mounting screws "BBA4" is attached. (A switch mounting band is not attached. Please order the band separately.)  
 "BBA4" screws are used for D-C7/C8/H7.  
 "D-H7BAL" switch is set on the cylinder with the screws above when shipped.  
 Also, when a switch only is shipped, "BBA4" screws are attached.

## With Air Cushion

**CJ2W** **Mounting** **Bore size** **Stroke** **A**  
 With air cushion ●

With covers on both sides equipped with the cushion function, the cylinder absorbs the impact during high-speed operation.



## Specifications

Action	Double acting/Double rod
Lubrication	Non-lube
Bore size (mm)	ø10, ø16
Max. operating pressure	0.7MPa
Min. operating pressure	0.1MPa
Piston speed	50 to 1000mm/s
Mounting	Basic, Foot, Flange

## Cushion Mechanism

Bore size mm	Effective cushion length (mm)	Allowable kinetic energy (J)
10	9.4	0.07J
16	9.4	0.18J

\* Refer to p.1.3-16 for the construction.

## Weight

Bore size (mm)		6	10	16
Basic weight*		27	35	70
Additional weight for each 15 of stroke		3	6	9
Mounting bracket weight	Foot	16	16	40
	Flange	5	5	15

\* This basic weight includes weights of mounting nut and rod end nut.

Calculation example)

### CJ2WL10-45

- Basic weight: 35 (ø10)
- Additional weight: 6/15 stroke
- Cylinder stroke: 45 stroke
- Mounting bracket weight: 16 (Foot)  
35+6/15 X 45+16=69g
- Refer to p.1.3-4 for weight of the accessory.

## Theoretical Force

Refer to the "Double acting cylinder" in Theoretical Force Table 1 of Technical data 3 on p.5.6-7  
 In the case of the double rod style, the force at IN side will be its theoretical force.

## Copper Free

**20-CJ2W** **Mounting** **Bore size** **Stroke**  
 Copper free ●

To eliminate influences of copper ions or halogen ions during CRT manufacturing processes, copper and fluorine materials are not used as component parts.



## Specifications

Action	Double acting/Double rod	
Bore size (mm)	ø6, ø10, ø16	
Max. operating pressure	0.7MPa	
Min. operating pressure	ø6	0.15MPa
	ø10, ø16	0.1MPa
Cushion	Rubber	
Standard stroke (mm)	15, 30, 45, 60mm	
Auto switch	Possible to be mounted	
Mounting	Basic, Foot, Flange	

CJ1

CJP

CJ2

CM2

C85

CG1

MB

C95

CA1

CS1

# Series CJ2W

## Clean Series

10-CJ2W Mounting Bore size Stroke

• Clean series

The rod section of actuator is reinforced with the double-seal structure. The air cylinder can be incorporated in the system which directly discharges the external leak from the clean room through the relief port.

### Specifications

Action	Double acting/Double rod
Bore size	ø10, ø16
Max. operating pressure	0.7MPa
Min. operating pressure	0.1MPa
Cushion	Rubber bumper
Standard stroke	Same as the standard (Refer to p.1.3-14)
Auto switch	Possible to be mounted
Mounting	Basic, Axial foot, Front flange

## Construction

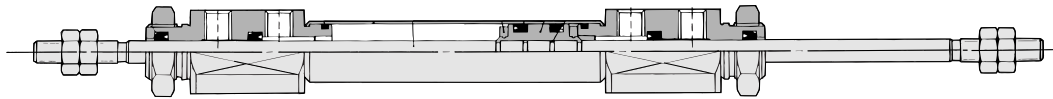

### Construction (The cylinder cannot be disassembled.)

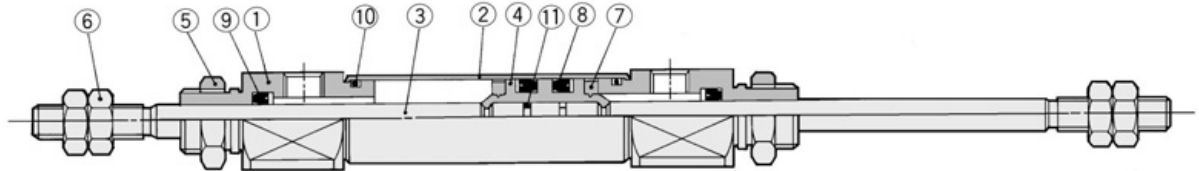
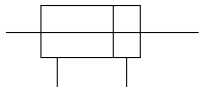

With air cushion

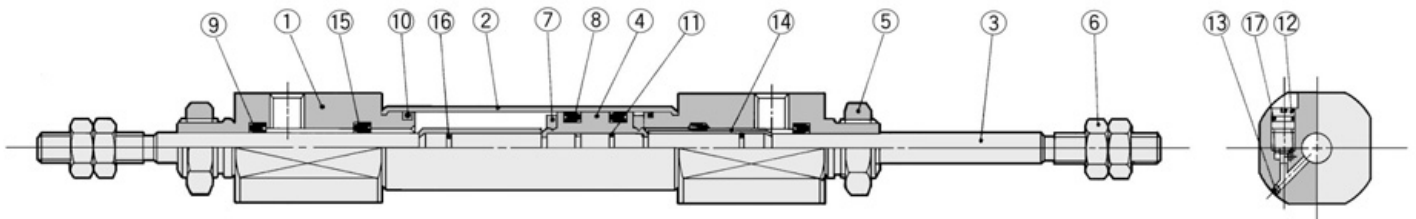

### Component Parts

No.	Description	Material	Note
①	Rod cover	Aluminum alloy	White anodized
②	Cylinder tube	Stainless steel	
③	Piston rod	Stainless steel	
④	Piston	Brass	
⑤	Mounting nut	Brass	Nickel plated
⑥	Rod end nut	Rolled steel	Nickel plated
⑦	Bumper	Urethane	
⑧	Piston seal	NBR	
⑨	Rod seal	NBR	
⑩	Tube gasket	NBR	
⑪	Piston gasket	NBR	

### For Air Cushion Style

No.	Description	Material	Note
⑫	Cushion needle	Stainless steel	
⑬	Steel ball	Bearing steel	
⑭	Cushion ring	Brass	
⑮	Check seal	NBR	
⑯	Cushion ring gasket	NBR	
⑰	Needle seal	NBR	



# Standard: Double Acting Double Rod *Series CJ2W*

Basic (B) 

CJ2WB

CJ2WB6  
Rod cover

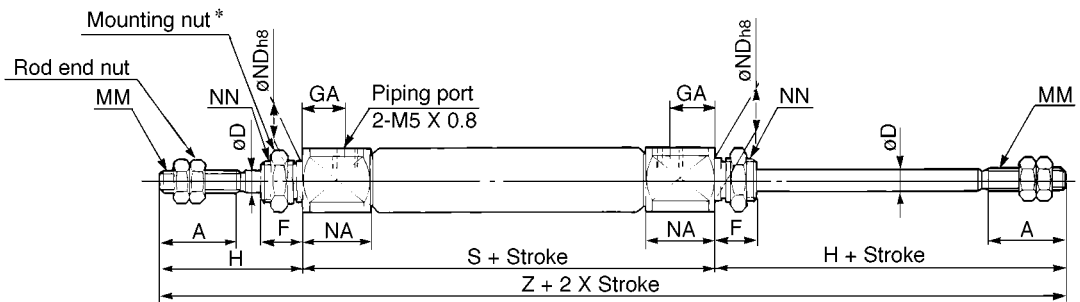
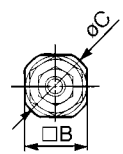
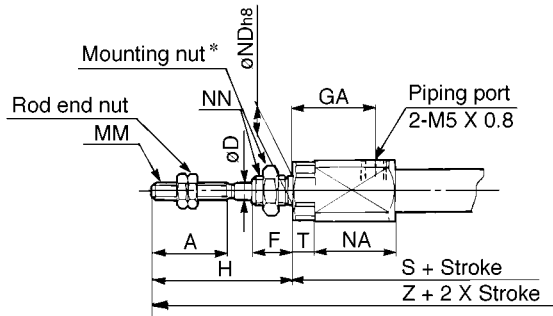
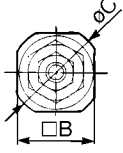

- CJ1
- CJP
- CJ2**
- CM2
- C85
- CG1
- MB
- C95
- CA1
- CS1

With air cushion: CJ2WB

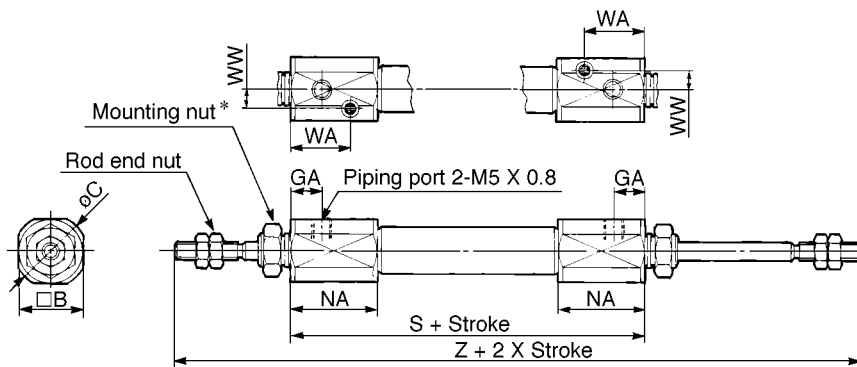

Rod end nut

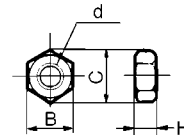

Material: Iron

Part No.	Bore size	B	C	d	H
NTJ-006A	6	5.5	6.4	M3 X 0.5	2.4
NTJ-010A	10	7	8.1	M4 X 0.7	3.2
NTJ-015A	16	8	9.2	M5 X 0.8	4

\* Refer to p.1.3-12 for details of the mounting nut.

Bore	A	B	C	D	F	GA	H	MM	NA	ND h8	NN	S*	T	Z*
6	15	12	14	3	8	14.5	28	M3 X 0.5	16	6 <sup>0</sup> <sub>-0.018</sub>	M6 X 1.0	61 (66)	3	117 (122)
10	15	12	14	4	8	8	28	M4 X 0.7	12.5	8 <sup>0</sup> <sub>-0.022</sub>	M8 X 1.0	49	—	105
16	15	18	20	5	8	8	28	M5 X 0.8	12.5	10 <sup>0</sup> <sub>-0.022</sub>	M10 X 1.0	50	—	106

With air cushion/Dimensions not mentioned in the below table are the same as the above table.

Bore	B	C	GA	NA	WA	WW	S	Z
10	15	17	7.5	21	14.5	4.5	66	122
16	18	20	7.5	21	14.5	5.5	67	123



Basic  
 CJ2WB6.....SCJ26, #6  
 CJ2WB10.....SCJ210, #6  
 CJ2WB16.....SCJ216, #6

\* The data shows auto switch styles.  
 Please delete the unnecessary parts.

# Series CJ2W



CJ2WL Bore size Stroke

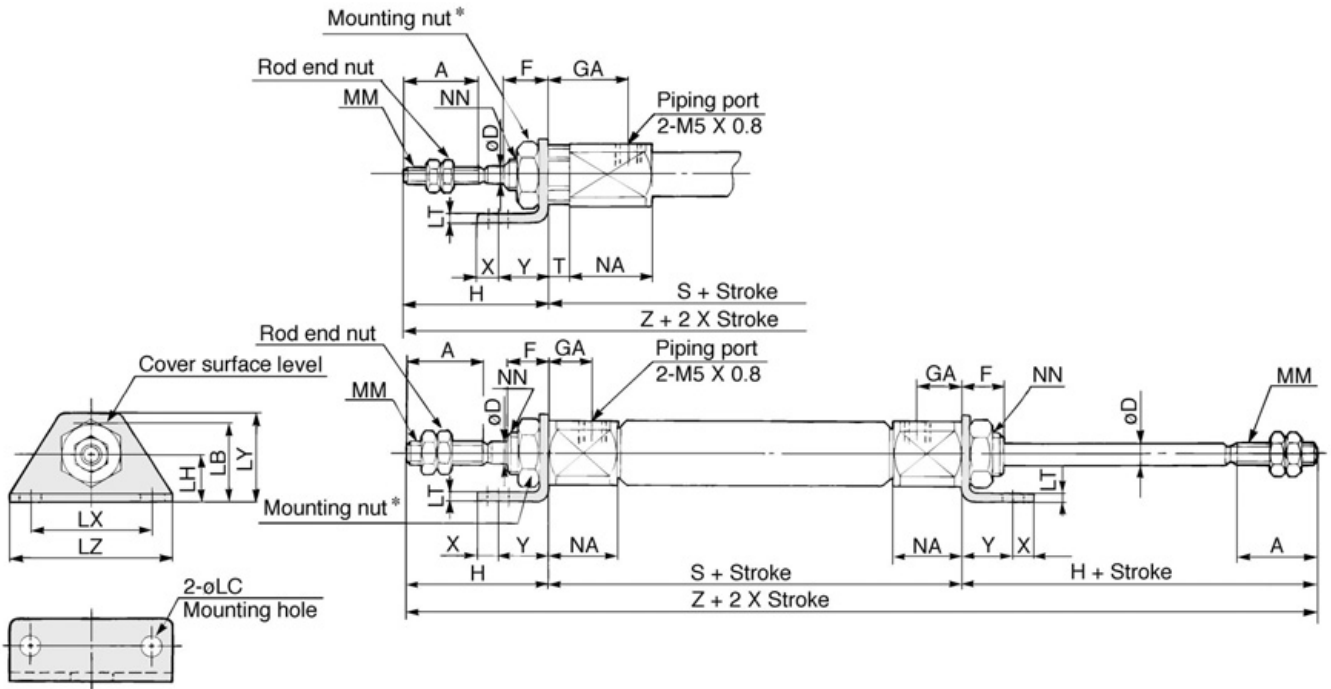

With air cushion: CJ2WL Bore size Stroke A

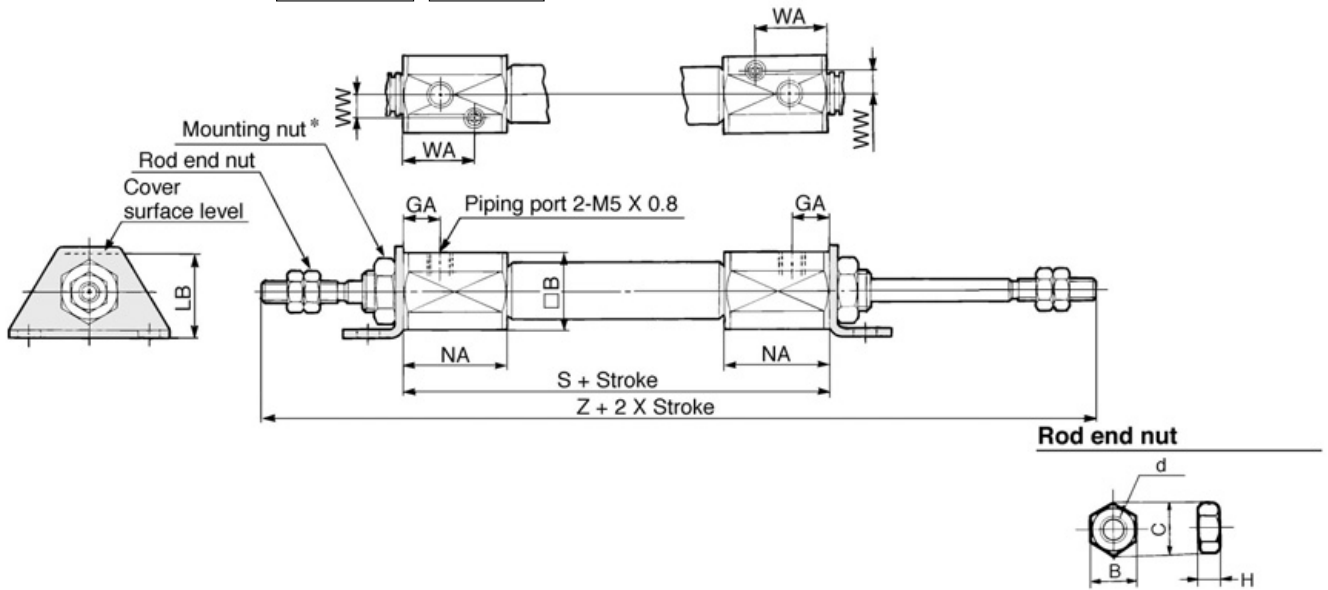

Material: Iron

Part No.	Bore	B	C	d	H
NTJ-006A	6	5.5	6.4	M3 X 0.5	2.4
NTJ-010A	10	7	8.1	M4 X 0.7	3.2
NTJ-015A	16	8	9.2	M5 X 0.8	4

\* Refer to p.1.3-12 for details of the mounting nut.

Bore	A	D	F	GA	H	LB	LC	LH	LT	LX	LY	LZ	MM	NA	NN	S*	T	X	Y	Z*
6	15	3	8	14.5	28	15	4.5	9	1.6	24	16.5	32	M3 X 0.5	16	M6 X 1.0	61 (66)	3	5	7	117 (122)
10	15	4	8	8	28	15	4.5	9	1.6	24	16.5	32	M4 X 0.7	12.5	M8 X 1.0	49	—	5	7	105
16	15	5	8	8	28	23	5.5	14	2.3	33	25	42	M5 X 0.8	12.5	M10 X 1.0	50	—	6	9	106

With air cushion / Dimensions not mentioned in the below table are the same as the above table.

Bore	B	GA	LB	NA	WA	WW	S	Z
10	15	7.5	16.5	21	14.5	4.5	66	122
16	18	7.5	23	21	14.5	5.5	67	123

\* ( ) in S or Z dimensions: With auto switch



Basic With foot  
 CJ2WL6.....SCJ26, #6 SCJ26, #6, #3  
 CJ2WL10.....SCJ210, #6 SCJ210, #6, #3  
 CJ2WL16.....SCJ216, #6 SCJ216, #6, #3

\* The data shows auto switch styles.  
 Please delete the unnecessary parts.

# Standard: Double Acting Double Rod *Series CJ2W*



CJ2WF Bore size Stroke

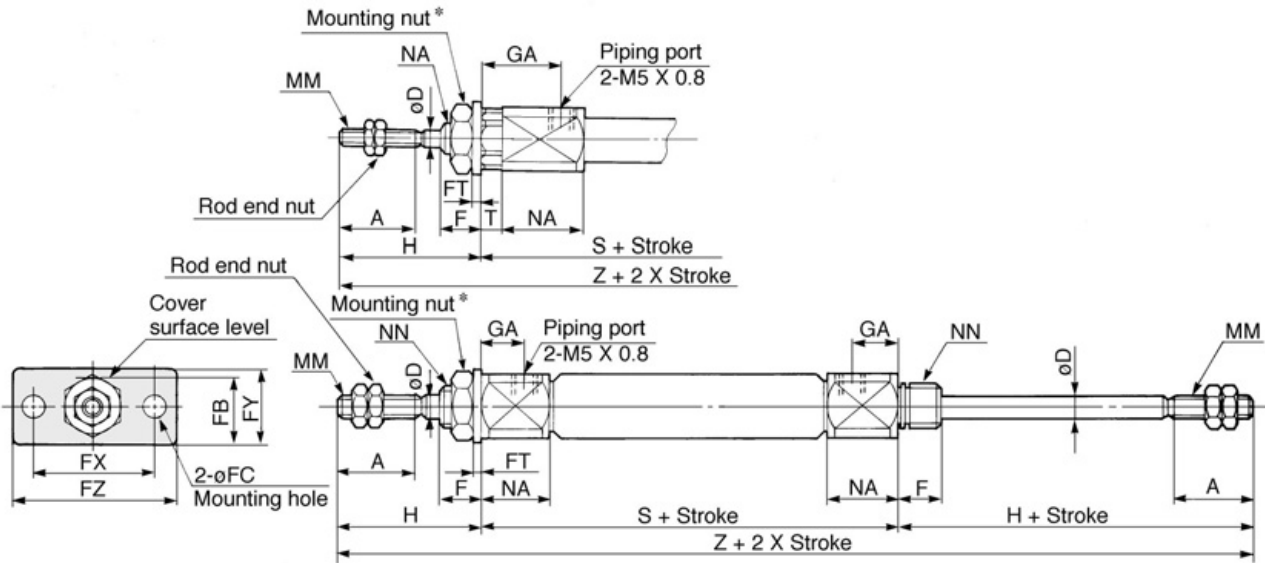

- CJ1
- CJP
- CJ2**
- CM2
- C85
- CG1
- MB
- C95
- CA1
- CS1

With air cushion: CJ2WF Bore size Stroke A

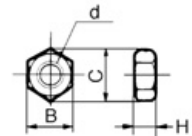
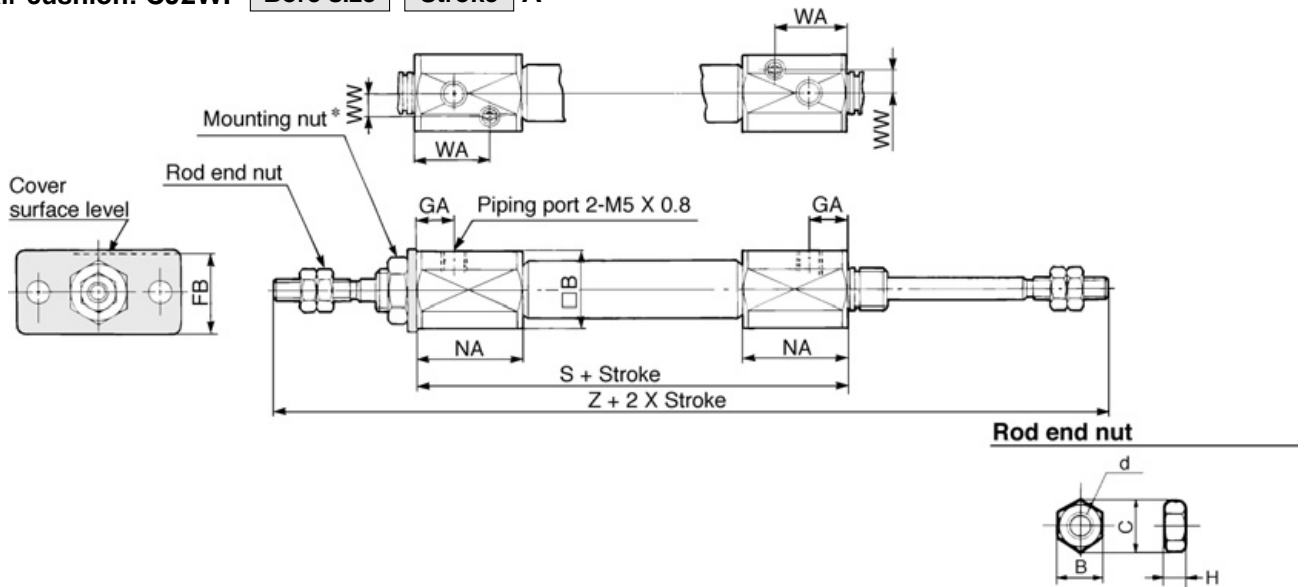

Material: Iron

Part No.	Bore	B	C	d	H
NTJ-006A	6	5.5	6.4	M3 X 0.5	2.4
NTJ-010A	10	7	8.1	M4 X 0.7	3.2
NTJ-015A	16	8	9.2	M5 X 0.8	4

\* Refer to p.1.3-12 for details of the mounting nut.

Bore	A	D	F	FB	FC	FT	FX	FY	FZ	GA	H	MM	NA	NN	S*	T	Z*
6	15	3	8	13	4.5	1.6	24	14	32	14.5	28	M3 X 0.5	16	M6 X 1.0	61 (66)	3	117 (122)
10	15	4	8	13	4.5	1.6	24	14	32	8	28	M4 X 0.7	12.5	M8 X 1.0	49	—	105
16	15	5	8	19	5.5	2.3	33	20	42	8	28	M5 X 0.8	12.5	M10 X 1.0	50	—	106

With air cushion / Dimensions not mentioned in the below table are the same as the above table.

Bore	B	FB	GA	NA	WA	WW	S	Z
10	15	14.5	7.5	21	14.5	4.5	66	122
16	18	19	7.5	21	14.5	5.5	67	123



Basic Flange  
 CJ2WF6.....SCJ26, #6 SCJ26, #6, #4  
 CJ2WF10.....SCJ210, #6 SCJ210, #6, #4  
 CJ2WF16.....SCJ216, #6 SCJ216, #6, #4

\* The data shows auto switch styles.  
 Please delete the unnecessary parts.

# Standard: Single Acting Spring Return/Extend

# Series CJ2



ø6, ø10, ø16

## How to Order

Spring extend

Spring return

**Bore size**

6	6mm
10	10mm
16	16mm

**Standard stroke**

ø6	15, 30, 45, 60
ø10	15, 30, 45, 60
ø16	15, 30, 45, 60, 75, 100, 125, 150

**Mounting**

B	Basic
L	Axial foot
F	Front flange
D	Double clevis (Except for ø6)

**Action**

S	Single acting/Spring return
T	Single acting/Spring extend

**Standard**

CJ2 L 16 45 S R

**With auto switch**

CDJ2 L 16 45 S R C73

**With auto switch**  
Built-in magnet

**Port location on head cover**

Bore		ø6	ø10, ø16
Symbol		—	Perpendicular
R		In-line	In-line

\* Refer to p.1.3-4 for the configuration.  
\* Not applicable to single acting/spring extend style (T).

**Auto switch**

\* Refer to the table below for selecting applicable auto switches.

—	2
S	1
n	n

\* If requiring a built-in-magnet cylinder without an auto switch, refer to the model number example below.

### Applicable Auto Switches/Refer to p.5.3-2 for further information on auto switch.

Style	Special function	Electrical entry	Indicator	Wiring (Output)	Load voltage		Auto switch model		Lead wire*				Applicable load								
					DC	AC	Band (ø6, ø10, ø16)	Rail (ø10, ø16)	0.5 (-)	3 (L)	5 (Z)	None (N)	IC	Relay PLC							
Reed switch	—	Grommet	Yes	3 wire (NPN)	—	5V	—	C76	—	A76H	●	●	—	—	IC	—					
								—	—	A72	A72H	●	●	—	—	—	—				
								—	200V	—	A73	A73H	●	●	●	—	—	—			
								12V	100V	C80	A80	A80H	●	●	—	—	IC	Relay PLC			
								5V, 12V	≤100V	—	C73C	A73C	—	—	●	●	●		—		
								12V	—	—	C80C	A80C	—	—	●	●	●		—		
5V, 12V	≤24V	—	—	A79W	—	—	●	●	—	—											
Solid state switch	—	Grommet	Yes	3 wire (NPN)	5V, 12V	—	H7A1	F7NV	F79	●	●	○	—	IC	Relay PLC						
							H7A2	F7PV	F7P	●	●	○	—	—							
							—	—	H7B	F7BV	J79	●	●	○		—					
							12V	—	H7C	J79C	—	●	●	●		—					
							Connector	No	2 wire	24V	5V, 12V	—	H7NW	F7NWV		F79W	●	●	○	—	IC
													H7PW	—		F7PW	●	●	○	—	—
		H7BW	F7BWV	J79W	●	●							○	—		—					
		12V	—	H7BA	—	F7BA							—	●		○	—				
		Grommet	Yes	3 wire (NPN)	5V, 12V	—							—	—		F7NT	—	●	○	—	IC
													—	—		F79F	●	●	○	—	—
		Grommet	No	2 wire	24V	5V, 12V	—	H7LF	—	F7LF	●	●	○	—		—					
								—	—	—	—	—	—	—		—					
—	—							—	—	—	—	—	—	—							
—	—							—	—	—	—	—	—	—							
—	—							—	—	—	—	—	—	—							
—	—							—	—	—	—	—	—	—							

\* Lead wire length 0.5m..... e.g.) C73C 5m.....Z e.g.) C73CZ  
3m.....L C73CL None.....N C73CN

\* Solid state switches marked with "○" are manufactured upon receipt of order.

### Part No. of Cylinder with Built-in Magnet

Symbol "-A" (rail mounting) or "-B" (band mounting) should be suffixed to the part No. of the cylinder with auto switch.

Ex.	Rail mounting	CDJ2B16-60S-A
	Band mounting	CDJ2B10-45S-B

# Standard: Single Acting Spring Return/Extend *Series CJ2*

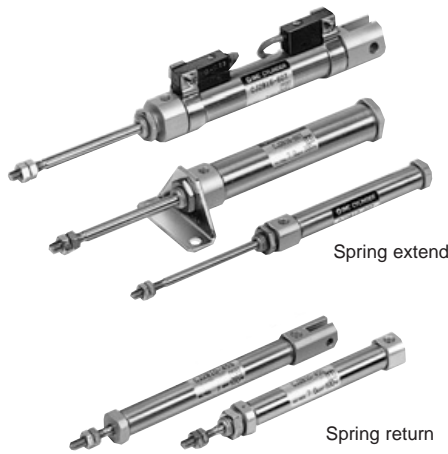

## JIS symbol

Single acting/  
Spring return

Single acting/  
Spring extend

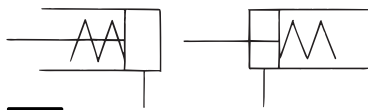

**Order Made** Made to Order

Refer to p.5.4-1 for made to order products of series CJ2 single acting style.

## ⚠ Precautions

Be sure to read before handling. Refer to p.0-39 to 0-46 for Safety Instructions and common precautions.

### ⚠ Caution

#### Mounting

- ① During installation, secure the rod cover and tighten by applying an appropriate tightening force to the retaining nut or to the rod cover body. If the head cover is secured or the head cover body is tightened, the cover could rotate, leading to a deviation.
- ② Tighten the retaining screws to an appropriate tightening torque within the range given below.  
 $\phi 6$ : 2.1 to 2.5Nm,  $\phi 10$ : 5.9 to 6.4Nm,  $\phi 16$ : 10.8 to 11.8Nm
- ③ In the case of the single acting cylinder, do not operate it in such a way that a load would be applied during the retraction of the piston rod of the spring return style, or during the extension of the piston rod of the spring extend style. The spring that is built into the cylinder provides only enough force to retract the piston rod. Thus, if a load is applied, the piston rod will not be able to retract to the end of the stroke.
- ④ In the case of the single acting cylinder, a breather hole is provided in the cover surface. Make sure not to block this hole during installation, as this could lead to a malfunction.
- ⑤ To remove and install the snap ring for the knuckle pin or the clevis pin, use an appropriate pair of pliers (tool for installing a C type snap ring). In particular, use a pair of ultra-mini pliers such as the Super Tool CSM-07A for removing and installing the snap rings on the  $\phi 10$  cylinder.
- ⑥ In the case of the auto switch rail mounting, do not remove the rail that is mounted. Because the retaining screws extend into the cylinder, this could lead to an air leak.

## Specifications

Action	Single acting/Spring return	Single acting/Spring extend
Fluid	Air	
Proof pressure	1.05MPa	
Max. operating pressure	0.7MPa	
Min. operating pressure	$\phi 6$	0.2MPa
	$\phi 10, \phi 16$	0.15MPa
Ambient and fluid temperature	Without auto switch: $-10^{\circ}\text{C}$ to $70^{\circ}\text{C}$ , With auto switch: $-10^{\circ}\text{C}$ to $60^{\circ}\text{C}^*$	
Cushion	Rubber bumper	
Lubrication	Non-lube	
Thread tolerance	JIS class 2	
Stroke tolerance	$+1.0$ $0$	
Piston speed	50 to 750mm/s	
Allowable kinetic energy	$\phi 6$	0.012J
	$\phi 10$	0.035J
	$\phi 16$	0.090J

\* No freezing

## Standard Stroke (mm)

Bore size	Standard stroke
<b>6</b>	15, 30, 45, 60
<b>10</b>	15, 30, 45, 60
<b>16</b>	15, 30, 45, 60, 75, 100, 125, 150

## Spring Force (N)

Bore size (mm)	Retracted position	Extended position
<b>6</b>	3.72	1.77
<b>10</b>	6.86	3.53
<b>16</b>	14.2	6.86

## Minimum Strokes for Auto Switch Mounting

Mounting	Auto switch model	Number of switches	Min. stroke (mm)	
Band mounting $\phi 6$ $\phi 10$ $\phi 16$	D-C7 D-C8	2 (same surface)	50	
		2 (different surfaces)	15	
		1	10	
	D-H7□ D-H7□W <sup>(1)</sup> D-H7BAL <sup>(1)</sup> D-H7NF <sup>(1)</sup>	2 (same surface)	60	
		2 (different surfaces)	15	
		1	10	
		D-C73C D-C80C D-H7C	2 (same surface)	65
	2 (different surfaces)		15	
	1		10	
	D-H7LF <sup>(1)</sup>	2 (same surface)	65	
		2 (different surfaces)	25	
		1	15	
Rail mounting $\phi 10$ $\phi 16$		D-A7/A8 D-A7□H/A80H D-A73C/A80C	2	10
			1	5
	D-F7 D-J79 D-F7□V D-J79C		2	5
		1	5	
		D-A79W D-F7□W D-J79W D-F7BAL D-F7□WV D-F79F	2	15
	1		10	
				2
	1		15	

Note 1) Cannot be mounted on  $\phi 6$  cylinder.

CJ1

CJP

**CJ2**

CM2

C85

CG1

MB

C95

CA1

CS1

# Series CJ2

## Weight/Spring Return (S) (g)

Bore size (mm)		6	10	16
Basic weight*	15 Stroke	11	28	63
	30 Stroke	16	35	80
	45 Stroke	18	44	102
	60 Stroke	23	53	124
	75 Stroke	—	—	145
	100 Stroke	—	—	188
	125 Stroke	—	—	224
Mounting bracket weight	150 Stroke	—	—	250
	Axial foot	8	8	20
	Front flange	5	5	15
	Double clevis** (with pins)	—	4	10

\* This basic weight includes weights of mounting nut and rod end nut.

\*\* The mounting nut is not attached to the double clevis, so the mounting nut weight is already reduced.

Calculation example) CJ2L10-45S

• Basic weight: ..... 44 (ø10-45 stroke)

• Mounting bracket weight: ..... 8 (Axial foot)  
44+8=52g

## Weight/Spring Extend (T) (g)

Bore size (mm)		6	10	16
Basic weight*	15 Stroke	17	28	64
	30 Stroke	21	34	80
	45 Stroke	23	43	100
	60 Stroke	27	51	121
	75 Stroke	—	—	140
	100 Stroke	—	—	178
	125 Stroke	—	—	212
Mounting bracket weight	150 Stroke	—	—	236
	Axial foot	8	8	20
	Front flange	5	5	15
	Double clevis** (with pins)	—	4	10

\* This basic weight includes weights of mounting nut and rod end nut.

\*\* The mounting nut is not attached to the double clevis, so the mounting nut weight is already reduced.

Calculation example) CJ2L10-45T

• Basic weight: ..... 43 (ø10-45 stroke)

• Mounting bracket weight: ..... 8 (Axial foot)  
43+8=52g

## Mounting Bracket Part No.

Mounting bracket	Bore size (mm)		
	6	10	16
Foot	CJ-L006B	CJ-L010B	CJ-L016B
Flange	CJ-F006B	CJ-F010B	CJ-F016B
T bracket*	—	CJ-T010B	CJ-T016B

\* T bracket is used with double clevis (D).

## Auto Switch Mounting Bracket Part No. (Band mounting)

Bore size (mm)	Bracket part No.	Note
6	BJ2-006	Common use to all of D-C7, C8 and D-H7
10	BJ2-010	
16	BJ2-016	



Note) A set of stainless steel mounting screws "BBA4" is attached. (A switch mounting band is not attached. Please order the band separately.) "BBA4" screws are used for D-C7/C8/H7. "D-H7BAL" switch is set on the cylinder with the screws above when shipped. Also, when a switch only is shipped, "BBA4" screws are attached.

## Mounting Accessories/Refer to p.1.3-12 for details.

Mounting		Basic	Axial foot	Front flange	Double clevis*
Standard	Mounting nut	●	●	●	—
	Rod end nut	●	●	●	●
	Clevis pin	—	—	—	●
Option	Single knuckle joint	●	●	●	●
	Double knuckle joint*	●	●	●	●
	T bracket	—	—	—	●

\* Double clevis or double knuckle joint are packaged with pins and set rings. Refer to p.1.3-4 for the accessory weight.

## Theoretical Force

Refer to the "Single acting/spring return cylinder" in Theoretical Force Table 1 of Technical data 3 on p.5.6-7. In the case of the spring extend style, the force at OUT side will be the ending force of the spring return, and that at the IN side will be the amount of the IN side force of the double acting style cylinder from which the beginning force of the spring return has been subtracted.

## Copper Free

20-CJ2 **Mounting** **Bore size** — **Stroke** **Action** **Port location on head cover**

### • Copper free

To eliminate influences of copper ions or halogen ions during CRT manufacturing processes, copper and fluorine materials are not used as component parts.

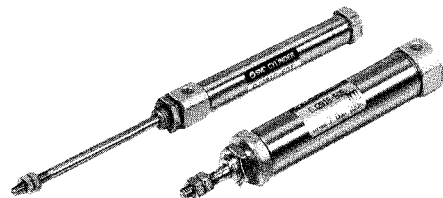

## Specifications

Action	Single acting/Spring return	Single acting/Spring extend
Bore size (mm)	ø6, ø10, ø16	
Max. operating pressure	0.7MPa	
Min. operating pressure	ø6	0.2MPa
	ø10, ø16	0.15MPa
Cushion	Rubber bumper	
Standard stroke (mm)	Same as the standard (Refer to p.1.3-21.)	
Auto switch	Possible to be mounted	
Mounting	Basic, Axial foot, Front flange, Double clevis (Except for ø6)	

# Standard: Single Acting Spring Return/Extend **Series CJ2**

## Construction (The cylinder cannot be disassembled.)

### Single acting/Spring return

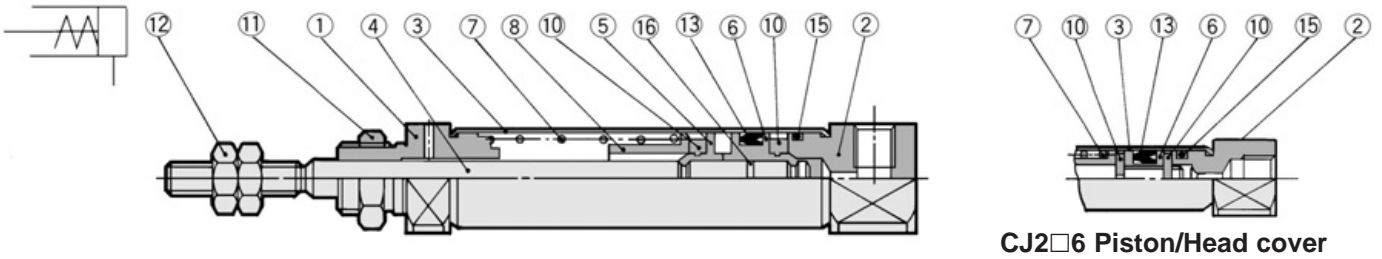

### Single acting/Spring extend

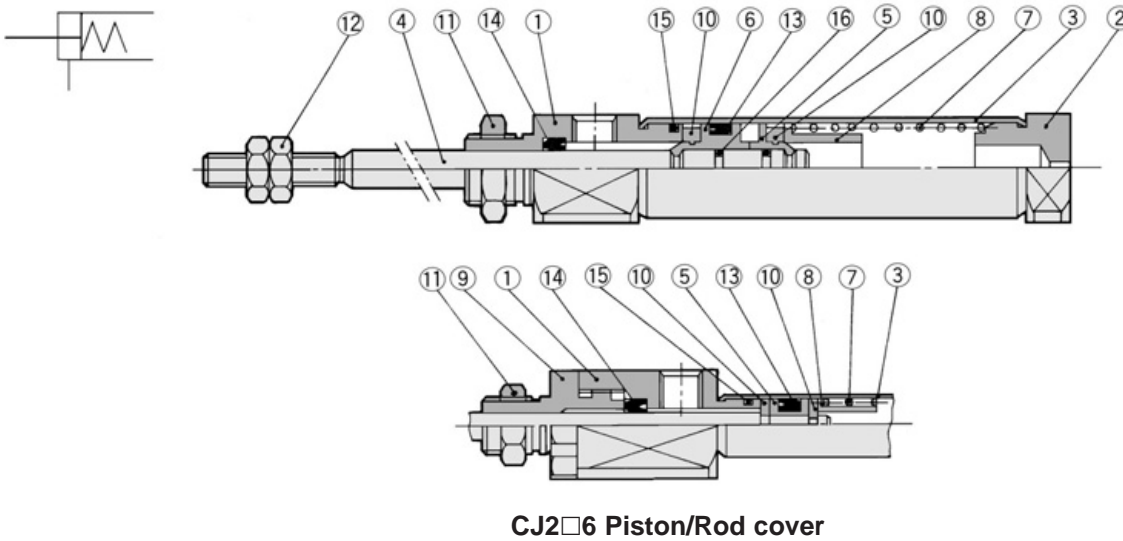

- CJ1
- CJP
- CJ2**
- CM2
- C85
- CG1
- MB
- C95
- CA1
- CS1

### Component Parts

No.	Description	Material	Note
①	Rod cover	Aluminum alloy	White anodized
②	Head cover	Aluminum alloy	White anodized
③	Cylinder tube	Stainless steel	
④	Piston rod	Stainless steel	
⑤	Piston A	Brass	
⑥	Piston B	Brass	
⑦	Return spring	Piano wire	
⑧	Spring seat	Brass	

No.	Description	Material	Note
⑨	Packing retainer	Aluminum alloy	White anodized (ø6 spring extend)
⑩	Bumper	Urethane	
⑪	Mounting nut	Brass	Nickel plated
⑫	Rod end nut	Rolled steel	Nickel plated
⑬	Piston seal	NBR	
⑭	Rod seal	NBR	
⑮	Tube gasket	NBR	
⑯	Piston gasket	NBR	

# Series CJ2

## Single Acting/Spring Return: Basic (B)



CJ2B Bore size — Stroke S Port location on head cover

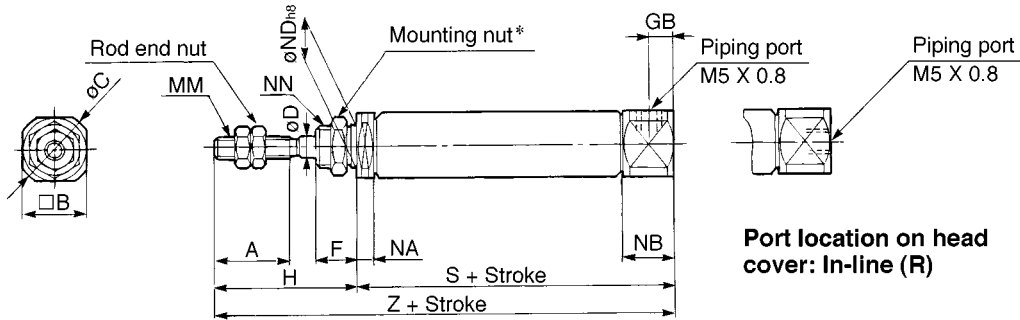

\* Refer to p.1.3-12 for details of the mounting nut.

Bore	A	B	C	D	F	GB	H	MM	NA	NB	ND h8	NN	S*								Z*							
													5 to 15st	16 to 30st	31 to 45st	46 to 60st	61 to 75st	76 to 100st	101 to 125st	126 to 150st	5 to 15st	16 to 30st	31 to 45st	46 to 60st	61 to 75st	76 to 100st	101 to 125st	126 to 150st
6	15	8	9	3	8	—	28	M3 X 0.5	3	7	6 <sup>0</sup> <sub>-0.018</sub>	M6 X 1.0	34.5 (39.5)	43.5 (48.5)	47.5 (52.5)	61.5 (66.5)	—	—	—	—	62.5 (67.5)	71.5 (76.5)	75.5 (80.5)	89.5 (94.5)	—	—	—	—
10	15	12	14	4	8	5	28	M4 X 0.7	5.5	9.5	8 <sup>0</sup> <sub>-0.022</sub>	M8 X 1.0	45.5	53	65	77	—	—	—	—	73.5	81	93	105	—	—	—	—
16	15	18	20	5	8	5	28	M5 X 0.8	5.5	9.5	10 <sup>0</sup> <sub>-0.022</sub>	M10 X 1.0	45.5	54	66	78	84	108	126	138	73.5	82	94	106	112	136	154	166

\* ( ) in S or Z dimensions: With auto switch

## Single Acting/Spring Return: Axial Foot (L)

CJ2L Bore size — Stroke S Port location on head cover

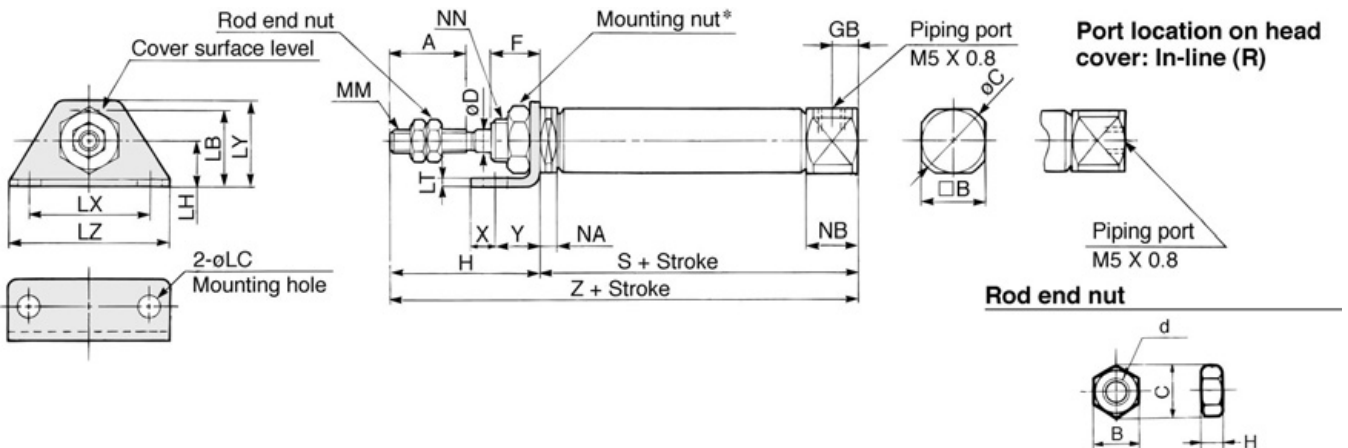

\* Refer to p.1.3-12 for details of the mounting nut.

Bore	A	B	C	D	F	GB	H	LB	LC	LH	LX	LY	LZ	MM	NA	NB	NN	X	Y	S*								Z*								
																				5 to 15st	16 to 30st	31 to 45st	46 to 60st	61 to 75st	76 to 100st	101 to 125st	126 to 150st	5 to 15st	16 to 30st	31 to 45st	46 to 60st	61 to 75st	76 to 100st	101 to 125st	126 to 150st	
6	15	8	9	3	8	—	28	13	4.5	9	1.6	24	16.5	32	M3 X 0.5	3	7	M6 X 1.0	5	7	34.5 (39.5)	43.5 (48.5)	47.5 (52.5)	61.5 (66.5)	—	—	—	—	62.5 (67.5)	71.5 (76.5)	75.5 (80.5)	89.5 (94.5)	—	—	—	—
10	15	12	14	4	8	5	28	15	4.5	9	1.6	24	16.5	32	M4 X 0.7	5.5	9.5	M8 X 1.0	5	7	45.5	53	65	77	—	—	—	—	73.5	81	93	105	—	—	—	—
16	15	18	20	5	8	5	28	23	5.5	14	2.3	33	25	42	M5 X 0.8	5.5	9.5	M10 X 1.0	6	9	45.5	54	66	78	84	108	126	138	73.5	82	94	106	112	136	154	166

Material: Iron

Part No.	Bore	B	C	d	H
NTJ-006A	6	5.5	6.4	M3 X 0.5	2.4
NTJ-010A	10	7	8.1	M4 X 0.7	3.2
NTJ-015A	16	8	9.2	M5 X 0.8	4

\* ( ) in S or Z dimensions: With auto switch



Basic With foot  
 CJ2B6.....SCJ26, #7 SCJ26, #7, #3  
 CJ2B10.....SCJ210, #7 SCJ210, #7, #3  
 CJ2B16.....SCJ216, #7 SCJ216, #7, #3

\* The data shows auto switch styles.  
 Please delete the unnecessary parts.



# Standard: Single Acting Spring Return/Extend **Series CJ2**

## Single Acting/Spring Return: Front Flange (F)



**CJ2F** Bore size — Stroke S Port location on head cover

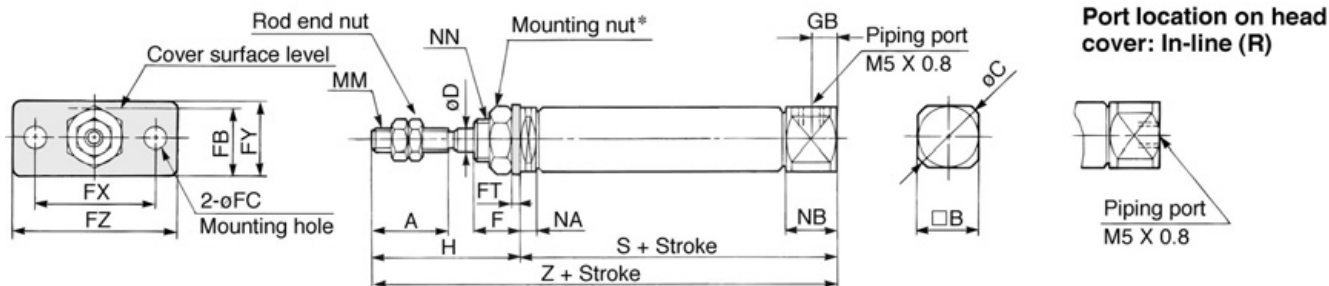

\* Refer to p01.3-12 for details of the mounting nut.

Bore	A	B	C	D	F	FB	FC	FT	FX	FY	FZ	GB	H	MM	NA	NB	NN	S*								Z*							
																		5 to 15st	16 to 30st	31 to 45st	46 to 60st	61 to 75st	76 to 100st	101 to 125st	126 to 150st	5 to 15st	16 to 30st	31 to 45st	46 to 60st	61 to 75st	76 to 100st	101 to 125st	126 to 150st
6	15	8	9	3	8	11	4.5	1.6	24	14	32	—	28	M3 X 0.5	3	7	M6 X 1.0	34.5 (39.5)	43.5 (48.5)	47.5 (52.5)	61.5 (66.5)	—	—	—	—	62.5 (67.5)	71.5 (76.5)	75.5 (80.5)	89.5 (94.5)	—	—	—	—
10	15	12	14	4	8	13	4.5	1.6	24	14	32	5	28	M4 X 0.7	5.5	9.5	M8 X 1.0	45.5	53	65	77	—	—	—	—	73.5	81	93	105	—	—	—	—
16	15	18	20	5	8	19	5.5	2.3	33	20	42	5	28	M5 X 0.8	5.5	9.5	M10 X 1.0	45.5	54	66	78	84	108	126	138	73.5	82	94	106	112	136	154	166

\*( ) in S or Z dimensions: With auto switch

## Single Acting/Spring Return: Double Clevis (D)

**CJ2D** Bore size — Stroke S

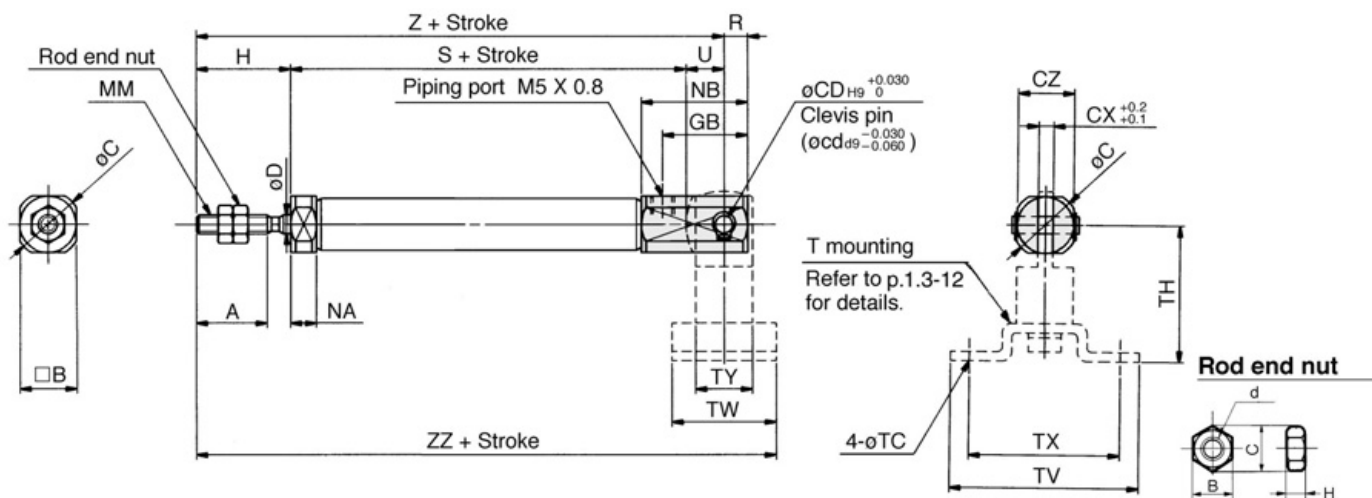

\* Clevis pins and set rings are attached.

Material: Iron

Part No.	Bore	B	C	d	H
NTJ-006A	6	5.5	6.4	M3 X 0.5	2.4
NTJ-010A	10	7	8.1	M4 X 0.7	3.2
NTJ-015A	16	8	9.2	M5 X 0.8	4

Bore	A	B	C	CD (cd)	CX	CZ	D	GB	H	MM	NA	NB	R	U	S								Z							
															5 to 15st	16 to 30st	31 to 45st	46 to 60st	61 to 75st	76 to 100st	101 to 125st	126 to 150st	5 to 15st	16 to 30st	31 to 45st	46 to 60st	61 to 75st	76 to 100st	101 to 125st	126 to 150st
10	15	12	14	3.3	3.2	12	4	18	20	M4 X 0.7	5.5	22.5	5	8	45.5	53	65	77	—	—	—	—	73.5	81	93	105	—	—	—	—
16	15	18	20	5	6.5	18	5	23	20	M5 X 0.8	5.5	27.5	8	10	45.5	54	66	78	84	108	126	138	75.5	84	96	108	114	138	156	168

Bore	ZZ							
	5 to 15st	16 to 30st	31 to 45st	46 to 60st	61 to 75st	76 to 100st	101 to 125st	126 to 150st
10	84.5	92	104	116	—	—	—	—
16	89.5	98	110	122	128	152	170	182

### T mounting dimensions

Bore size	TC	TH	TV	TW	TX	TU
10	4.5	29	40	22	32	12
16	5.5	35	48	28	38	16

Basic With flange  
 CJ2F6.....SCJ26, #7 SCJ26, #7, #4  
 CJ2F10.....SCJ210, #7 SCJ210, #7, #4  
 CJ2F16.....SCJ216, #7 SCJ216, #7, #4

\* The data shows auto switch styles.  
 Please delete the unnecessary parts.

# Series CJ2

## Single Acting/Spring Extend: Basic (B)

CJ2B Bore size — Stroke T

CJ2B6

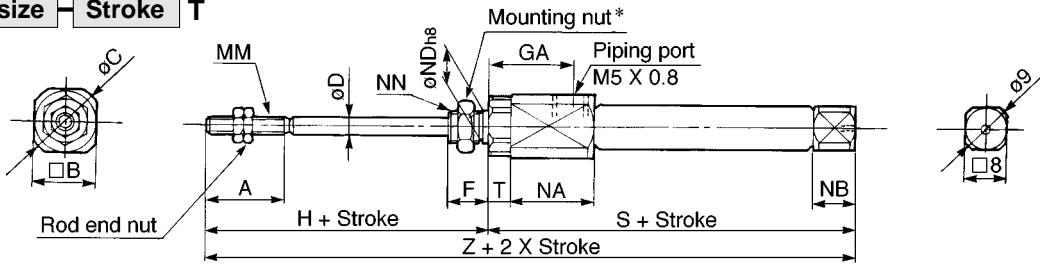

CJ2B10, 16

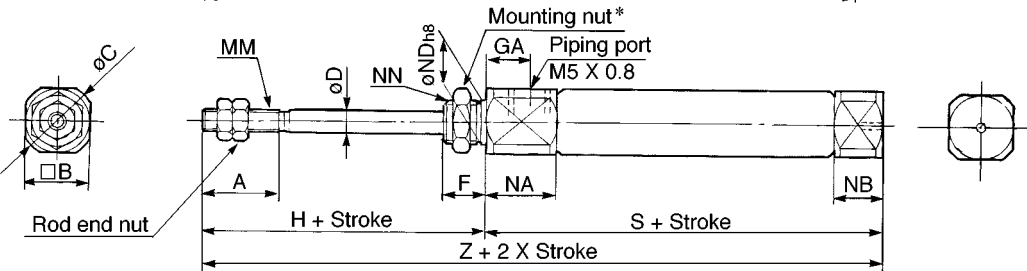

\* Refer to p.1.3-12 for details of the mounting nut.

Bore	A	B	C	D	F	GA	H	MM	NN	NA	NB	ND h8	T	S*												Z*					
														5 to 15st	16 to 30st	31 to 45st	46 to 60st	61 to 75st	76 to 100st	101 to 125st	126 to 150st	5 to 15st	16 to 30st	31 to 45st	46 to 60st	61 to 75st	76 to 100st	101 to 125st	126 to 150st		
6	15	12	14	3	8	14.5	28	M3 X 0.5	M6 X 1.0	16	3	6 <sup>0</sup> <sub>-0.018</sub>	3	46.5 (51.5)	55.5 (60.5)	59.5 (64.5)	73.5 (78.5)	—	—	—	—	74.5 (79.5)	83.5 (88.5)	87.5 (92.5)	101.5 (106.5)	—	—	—	—		
10	15	12	14	4	8	8	28	M4 X 0.7	M8 X 1.0	12.5	5.5	8 <sup>0</sup> <sub>-0.022</sub>	—	48.5	56	68	80	—	—	—	—	76.5	84	96	108	—	—	—	—		
16	15	18	20	5	8	8	28	M5 X 0.8	M10 X 1.0	12.5	5.5	10 <sup>0</sup> <sub>-0.022</sub>	—	48.5	57	69	81	87	111	129	141	76.5	85	97	109	115	139	157	169		

\* ( ) in S or Z dimensions: With auto switch

## Single Acting/Spring Extend: Axial Foot (L)

CJ2L Bore size — Stroke T

CJ2L6

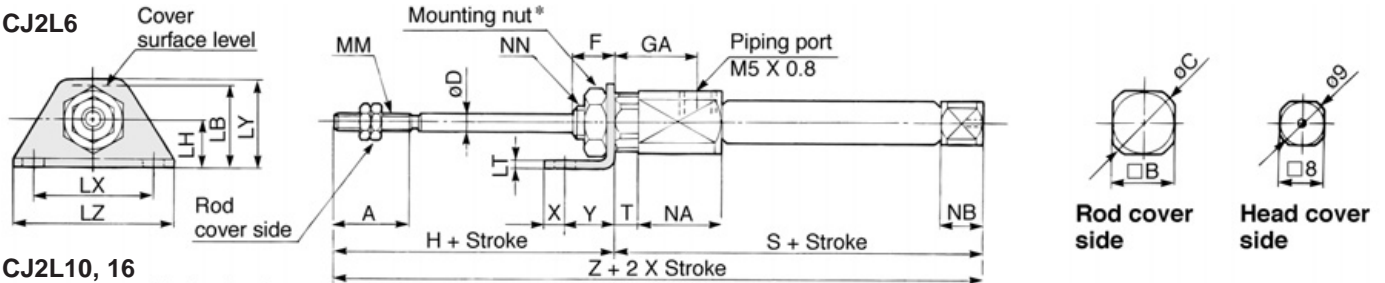

CJ2L10, 16

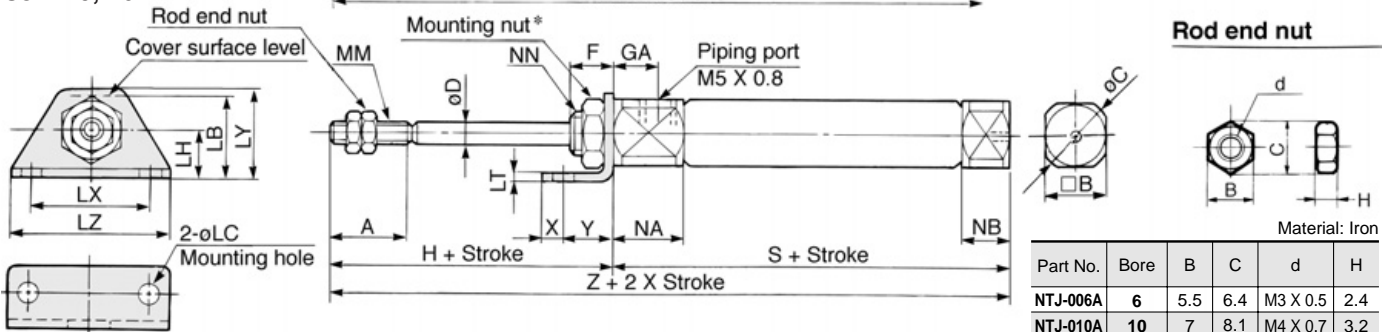

\* Refer to p.1.3-12 for details of the mounting nut.

Bore	A	B	C	D	F	GA	H	LB	LC	LH	LT	LX	LY	LZ	MM	NA	NB	NN	T	X	Y	S*												Z*					
																						5 to 15st	16 to 30st	31 to 45st	46 to 60st	61 to 75st	76 to 100st	101 to 125st	126 to 150st	5 to 15st	16 to 30st	31 to 45st	46 to 60st	61 to 75st	76 to 100st	101 to 125st	126 to 150st		
6	15	12	14	3	8	14.5	28	15	4.5	9	1.6	24	16.5	32	M3 X 0.5	16	3	M6 X 1.0	3	5	7	46.5 (51.5)	55.5 (60.5)	59.5 (64.5)	73.5 (78.5)	—	—	—	—	74.5 (79.5)	83.5 (88.5)	87.5 (92.5)	101.5 (106.5)	—	—	—	—		
10	15	12	14	4	8	8	28	15	4.5	9	1.6	24	16.5	32	M4 X 0.7	12.5	5.5	M8 X 1.0	—	5	7	48.5	56	68	80	—	—	—	—	76.5	84	96	108	—	—	—	—		
16	15	18	20	5	8	8	28	23	5.5	14	2.3	33	25	42	M5 X 0.8	12.5	5.5	M10 X 1.0	—	6	9	48.5	57	69	81	87	111	129	141	76.5	85	97	109	115	139	157	169		

\* ( ) in S or Z dimensions: With auto switch



Basic With foot  
 CJ2B6.....SCJ26, #8 SCJ26, #8, #3  
 CJ2B10.....SCJ210, #8 SCJ210, #8, #3  
 CJ2B16.....SCJ216, #8 SCJ216, #8, #3

\* The data shows auto switch equipped styles.  
 Please delete the unnecessary parts.

# Standard: Single Acting Spring Return/Extend *Series CJ2*



## Single Acting/Spring Extend: Front Flange (F)

**CJ2F** Bore size — Stroke T

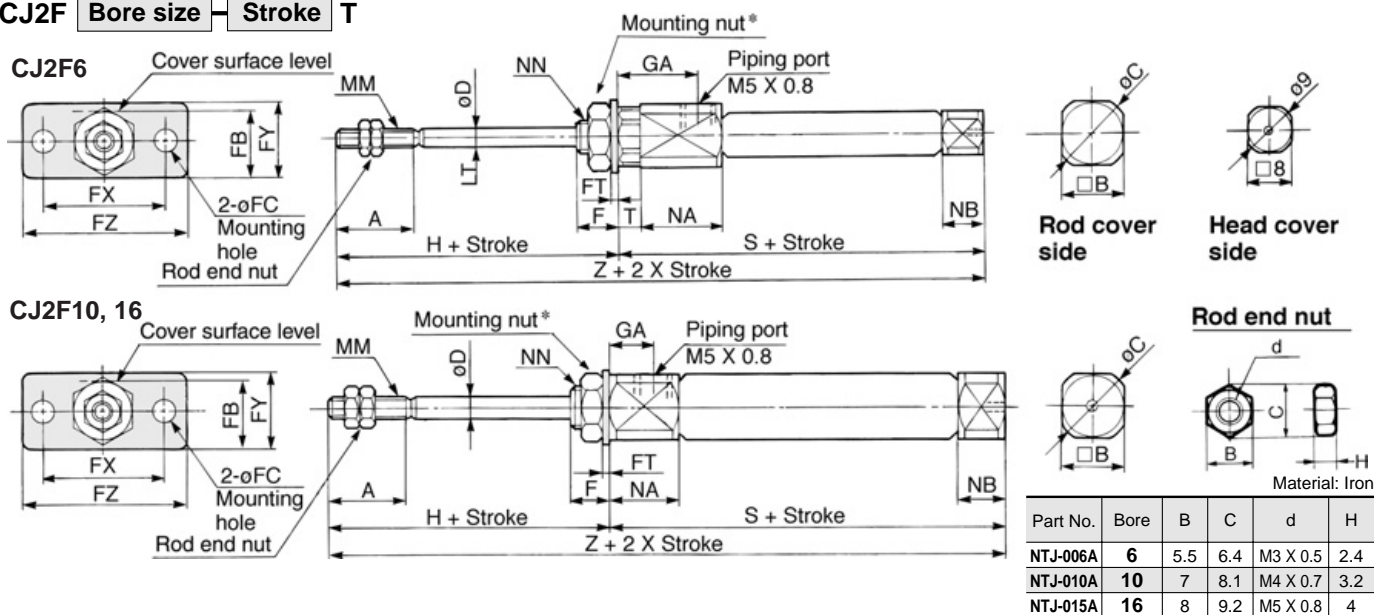

\* Refer to p.1.3-12 for details of the mounting nut.

Bore	A	B	C	D	F	FB	FC	FT	FX	FY	FZ	GA	H	MM	NA	NB	NN	T	S*								Z*							
																			5 to 15st	16 to 30st	31 to 45st	46 to 60st	61 to 75st	76 to 100st	101 to 125st	126 to 150st	5 to 15st	16 to 30st	31 to 45st	46 to 60st	61 to 75st	76 to 100st	101 to 125st	126 to 150st
6	15	12	14	3	8	13	4.5	1.6	24	14	32	14.5	28	M3 X 0.5	16	3	M6 X 1.0	3	46.5 (51.5)	55.5 (60.5)	59.5 (64.5)	73.5 (78.5)	—	—	—	—	74.5 (79.5)	83.5 (88.5)	87.5 (92.5)	101.5 (106.5)	—	—	—	—
10	15	12	14	4	8	13	4.5	1.6	24	14	32	8	28	M4 X 0.7	12.5	5.5	M8 X 1.0	—	48.5	56	68	80	—	—	—	—	76.5	84	96	108	—	—	—	—
16	15	18	20	5	8	19	5.5	2.3	33	20	42	8	28	M5 X 0.8	12.5	5.5	M10 X 1.0	—	48.5	57	69	81	87	111	129	141	76.5	85	97	109	115	139	157	169

\* ( ) in S or Z dimensions: With auto switch

## Single Acting/Spring Extend: Double Clevis (D)

**CJ2D** Bore size — Stroke T

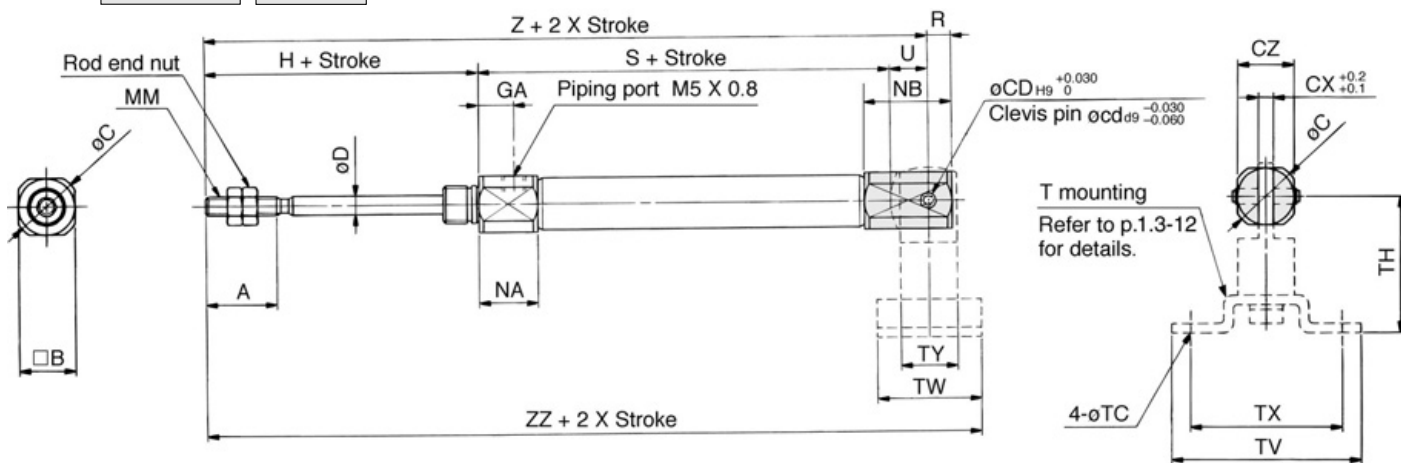

\* Clevis pins and set rings are attached.

Bore	A	B	C	CD (cd)	CX	CZ	D	GA	H	MM	NA	NB	R	U	S								Z							
															5 to 15st	16 to 30st	31 to 45st	46 to 60st	61 to 75st	76 to 100st	101 to 125st	126 to 150st	5 to 15st	16 to 30st	31 to 45st	46 to 60st	61 to 75st	76 to 100st	101 to 125st	126 to 150st
10	15	12	14	3.3	3.2	12	4	8	28	M4 X 0.7	12.5	18.5	5	8	48.5	56	68	80	—	—	—	—	84.5	92	104	116	—	—	—	—
16	15	18	20	5	6.5	18	5	8	28	M5 X 0.8	12.5	23.5	8	10	48.5	57	69	81	87	111	129	141	86.5	95	107	119	125	149	167	179

Bore	ZZ							
	5 to 15st	16 to 30st	31 to 45st	46 to 60st	61 to 75st	76 to 100st	101 to 125st	126 to 150st
10	95.5	103	115	127	—	—	—	—
16	100.5	109	121	133	139	163	181	193

### T mounting dimensions

Bore size	TC	TH	TV	TW	TX	TY
10	4.5	29	40	22	32	12
16	5.5	35	48	28	38	16

Basic With flange  
 CJ2F6.....SCJ26, #8 SCJ26, #8, #4  
 CJ2F10.....SCJ210, #8 SCJ210, #8, #4  
 CJ2F16.....SCJ216, #8 SCJ216, #8, #4

\* The data shows auto switch equipped styles.  
 Please delete the unnecessary parts.

# Series CDJ2

## Auto Switch Mounting Position: Single Acting/Spring Return (S)

### Reed Switch <Band mounting> D-C7/C8

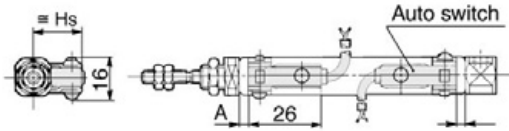

### D-C73C/C80C

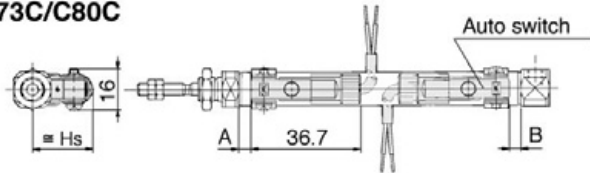

### <Rail mounting> D-A7/A8

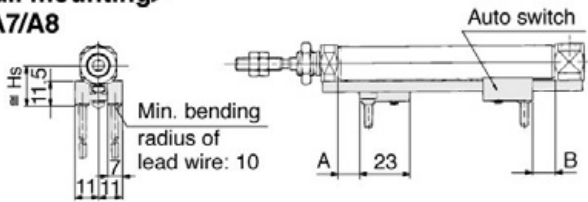

### D-A79W

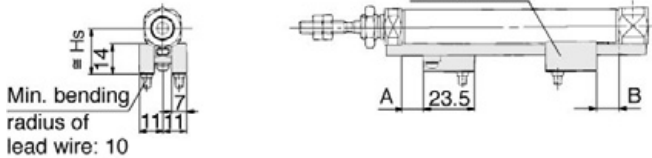

### D-A7□H/A80H

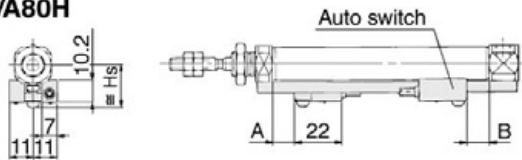

### D-A73C/A80C

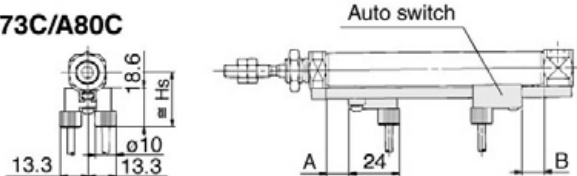

### Solid State Switch <Band mounting> D-H7□/H7□W/H7BAL D-H7□F

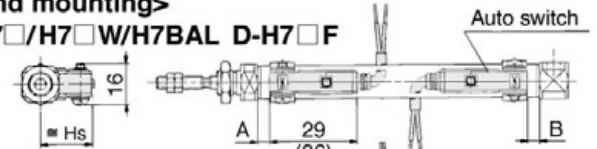

### D-H7C

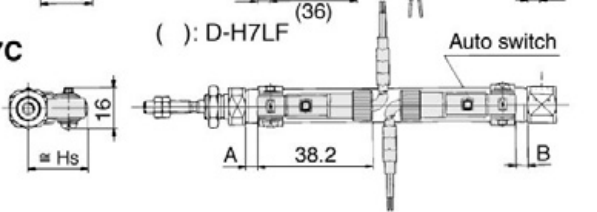

### <Rail mounting> D-F7/J7/D-F7□W/D-J79W

### D-F7□F/D-F7BAL

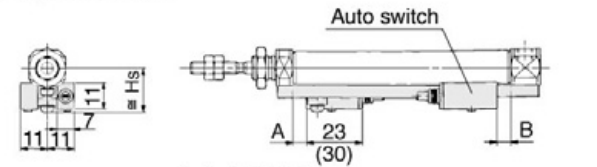

### D-F7□V/D-F7□WV

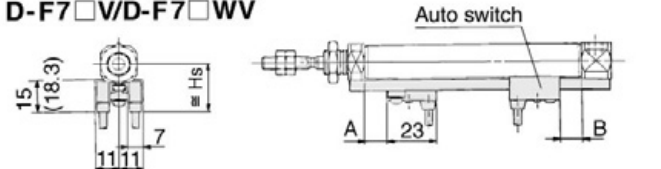

### D-J79C

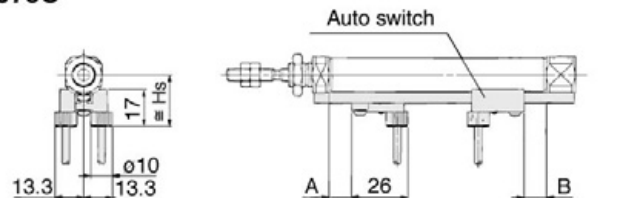

### Auto Switch Mounting Position/Spring Return

Auto switch model	Bore (mm)	A dimensions								B
		10 to 15 <sup>st</sup>	16 to 30 <sup>st</sup>	31 to 45 <sup>st</sup>	46 to 60 <sup>st</sup>	61 to 75 <sup>st</sup>	76 to 100 <sup>st</sup>	101 to 125 <sup>st</sup>	126 to 150 <sup>st</sup>	
D-C7/C8	6	8.5	17.5	21.5	35.5	—	—	—	—	2.0
D-C73C	10	9.0	16.5	28.5	40.5	—	—	—	—	2.5
D-C80C	16	8.5	17.0	29.0	41.0	47	71	89	101	3.0
D-H7□	6	7.5	16.5	20.5	34.5	—	—	—	—	1.0
D-H7C	10	8.0	15.5	27.5	39.5	—	—	—	—	1.5
	16	7.5	16.0	28.0	40.0	46	70	88	100	2.0
D-H7□W	6	6.0	15.0	19.0	33.0	—	—	—	—	0
D-H7□F	10	6.5	14.0	26.0	38.0	—	—	—	—	0
D-H7BAL	16	6.0	14.5	26.5	38.5	44.5	68.5	86.5	98.5	0.5
D-A7/A8	10	9.5	17.0	29.0	41.0	—	—	—	—	—
	16	9	17.5	29.5	41.5	47.5	71.5	89.5	101.5	3.5
D-A73C/A80C	10	10.0	17.5	29.5	41.5	—	—	—	—	3.5
D-F7/J7	16	9.5	18.0	30.0	42.0	48	72	90	102	4.0
D-A7□H/A80H	10	10.5	18.0	30.0	42.0	—	—	—	—	4.0
D-F7□V/J79C	16	10.0	18.5	30.5	42.5	48.5	72.5	90.5	102.5	4.5
D-F7□WV	10	14.0	21.5	33.5	45.5	—	—	—	—	7.5
D-F7BAL/F7□W	16	13.5	22.0	34.0	46.0	52	76	94	106	8.0
D-F7□F/J79W	10	7.0	14.5	26.5	38.5	—	—	—	—	0.5
D-A79W	16	6.5	15.0	27.0	39.0	45	69	87	99	1.0

### Auto Switch Mounting Height (mm)

Auto switch model	Bore (mm)	≡ HS
D-C7/C8	6	15.0
D-H7□/H7□W	10	17.0
D-H7□F/H7BAL	16	20.5
D-C73C	6	17.5
D-C80C	10	19.5
	16	23.0
D-H7C	6	18.0
	10	20.0
	16	23.5
D-A7	10	16.5
D-A8	16	19.5
D-A7□H/A80H	10	17.5
D-F7/J7	16	20.5
D-F7□W/J79W	10	23.5
D-F7BAL/F7□F	16	26.5
D-A73C/A80C	10	23.5
	16	26.5
D-F7□V	10	20.0
D-F7□WV	16	23.0
	10	23.0
D-J79C	16	26.0
	10	19.0
D-A79W	16	22.0

## Auto Switch Mounting Position: Single Acting/Spring Extend (T)

### Reed Switch <Band mounting> D-C7/C8

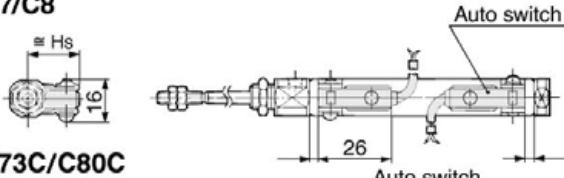

### D-C73C/C80C

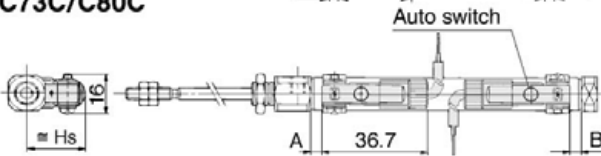

### Solid State Switch <Band mounting> D-H7□/H7□W/H7BAL/H7□F

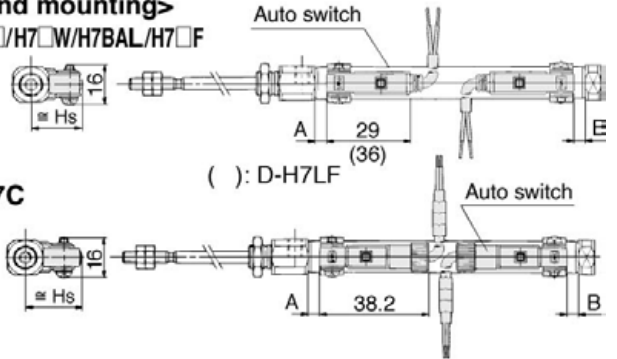

### D-H7C

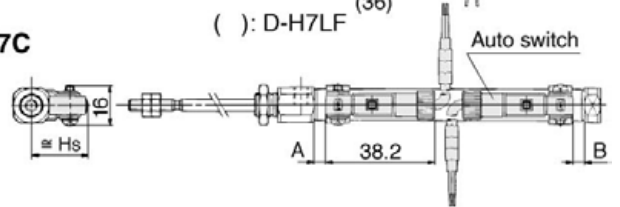

### <Rail mounting> D-A7/A8

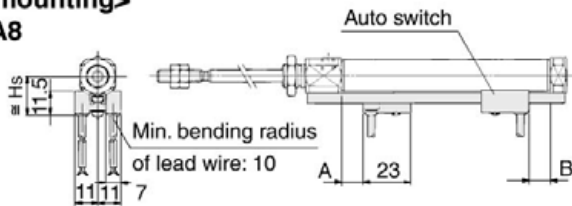

### D-A79W

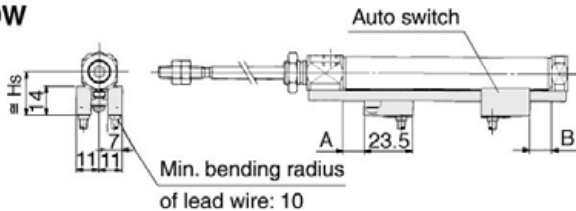

### D-A73C/A80C

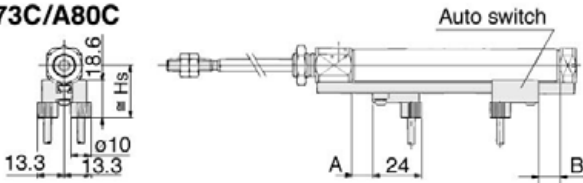

### D-A7□H/A80H

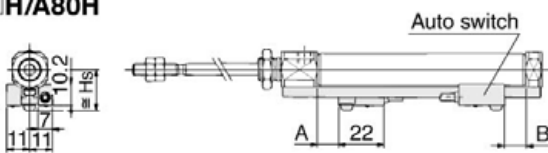

### <Rail mounting> D-F7/J7/D-F7□W/D-J79W D-F7□F/D-F7BAL

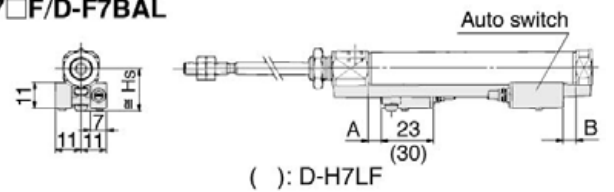

### D-F7□V/D-F7□WV

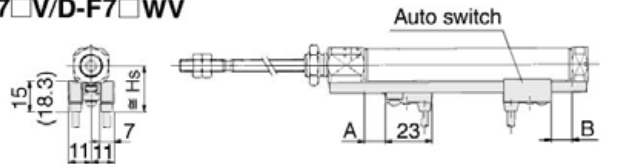

### D-J79C

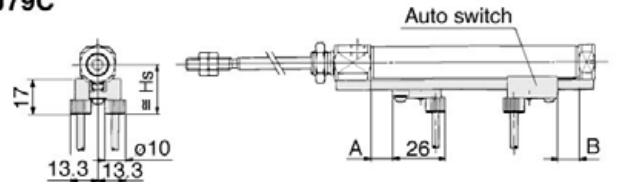

### Auto Switch Mounting Height (mm)

Auto switch model	Bore (mm)	≅ HS
D-C7/C8	6	15.0
D-H7□/H7□W	10	17.0
D-H7□F/H7BAL	16	20.5
D-C73C	6	17.5
D-C80C	10	19.5
	16	23.0
D-H7C	6	18.0
	10	20.0
	16	23.5
D-A7	10	16.5
D-A8	16	19.5
D-A7□H/A80H	10	17.5
D-F7/J7		
D-F7□W/J79W	16	20.5
D-F7BAL/F7□F		
D-A73C	10	23.5
D-A80C	16	26.5
D-F7□V	10	20.0
D-F7□WV	16	23.0
	10	23.0
D-J79C	16	26.0
	10	19.0
D-A79W	16	22.0

### Auto Switch Mounting Position/Spring Extend

Auto switch model	Bore (mm)	A	B dimensions (mm)								
			All stroke	10 to 15 <sup>St</sup>	16 to 30 <sup>St</sup>	31 to 45 <sup>St</sup>	46 to 60 <sup>St</sup>	61 to 75 <sup>St</sup>	76 to 100 <sup>St</sup>	101 to 125 <sup>St</sup>	126 to 150 <sup>St</sup>
D-C7/C8	6	2.0	8.5	17.5	21.5	35.5	—	—	—	—	
D-C73C	10	2.5	9.0	16.5	28.5	40.5	—	—	—	—	
D-C80C	16	3.0	8.5	17.0	29.0	41.0	47	71	89	101	
D-H7□	6	1.0	7.5	16.5	20.5	34.5	—	—	—	—	
D-H7C	10	1.5	8.0	15.5	27.5	39.5	—	—	—	—	
	16	2.0	7.5	16.0	28.0	40.0	46	70	88	100	
D-H7□W	6	0	6.0	15.0	19.0	33.0	—	—	—	—	
D-H7□F	10	0	6.5	14.0	26.0	38.0	—	—	—	—	
D-H7BAL	16	0.5	6.0	14.5	26.5	38.5	44.5	68.5	86.5	98.5	
D-A7/A8	10	3.0	9.5	17.0	29.0	41.0	—	—	—	—	
	16	3.5	9.0	17.5	29.5	41.5	47.5	71.5	87.5	101.5	
D-A73C/A80C	10	3.5	10.0	17.5	29.5	41.5	—	—	—	—	
D-F7/J7											
D-A7□H/A80H	16	4.0	9.5	18.0	30.0	42.0	48	72	90	102	
D-F7□V/J79C											
D-F7□WV	10	4.0	10.5	18.0	30.0	42.0	—	—	—	—	
	16	4.5	10.0	18.5	30.5	42.5	48.5	72.5	90.5	102.5	
D-F7BAL/F7□W	10	7.5	14.0	21.5	33.5	45.5	—	—	—	—	
D-F7□F/J79W	16	8.0	13.5	22.0	34.0	46.0	52	76	94	106	
D-A79W	10	0.5	7.0	14.5	26.5	38.5	—	—	—	—	
	16	1.0	6.5	15.0	27.0	39.0	45	69	87	99	

# Non-rotating Rod: Double Acting Single Rod

# Series CJ2K

ø10, ø16

## How to Order

**Bore size**

10	10mm
16	16mm

**Mounting**

B	Basic
L	Axial foot
F	Front flange
D	Double clevis

**Standard stroke (mm)**

ø10	15, 30, 45, 60, 75, 100, 125, 150
ø16	15, 30, 45, 60, 75, 100, 125, 150, 175, 200

**Standard**  
CJ2K L 16 60

**With auto switch**  
CDJ2K L 16 60 C73

**With auto switch (Built-in magnet)**

**Port location on head cover**

Symbol	Port location
—	Perpendicular
R	In-line

\* Refer to p.1.3-31 for the configuration.

**Auto switch**

\* Refer to the table below for selecting applicable auto switches.

\* If requiring a built-in-magnet cylinder without an auto switch, refer to the model number example below.

**Number of switches**

—	2
S	1
n	n

### Applicable Auto Switches/Refer to p.5.3-2 for further information on auto switch.

Style	Special function	Electrical entry	Indicator	Wiring (Output)	Load voltage		Auto switch model**		Lead wire* (m)				Applicable load					
					DC	AC	Band	Rail		0.5 (-)	3 (L)	5 (Z)	None (N)	IC	Relay PLC			
Reed switch	—	Grommet	Yes	3 wire (NPN)	—	5V	—	C76	—	A76H	●	●	—			—	Relay PLC	
					—	—	200V	—	A72	A72H	●	●	—	—				
				2 wire	12V	100V	C73	A73	A73H	●	●	●	—	—				
					5V, 12V	≤100V	C80	A80	A80H	●	●	—	—	IC				
					12V	—	C73C	A73C	—	●	●	●	●	—				
					5V, 12V	≤24V	C80C	A80C	—	●	●	●	●	IC				
Diagnostic indication (2 color)	Grommet	Yes	—	—	—	A79W	—	●	●	—	—	—						
Solid state switch	—	Grommet	Yes	3 wire (NPN)	5V, 12V	—	H7A1	F7NV	F79	●	●	○	—	Relay PLC				
				3 wire (PNP)			H7A2	F7PV	F7P	●	●	○	—					
				2 wire	12V	—	H7B	F7BV	J79	●	●	○	—					
					—	—	H7C	J79C	—	●	●	●	●		—			
				Diagnostic indication (2 color)	Grommet	Yes	3 wire (NPN)	5V, 12V	—	H7NW	F7NWV	F79W	●		●	○	—	Relay PLC
							3 wire (PNP)			H7PW	—	F7PW	●		●	○	—	
	2 wire	12V	—				H7BW	H7BWV	J79W	●	●	○	—					
		—	—				H7BA	—	F7BA	—	●	○	—					
	Water resistant (2 color)	Grommet	Yes				3 wire (NPN)	5V, 12V	—	—	—	F7NT	—	●	○	—	IC	
	With timer						—			—	F7NF	—	F79F	●	●	○		
	With diagnostic output (2 color)	Grommet	Yes	4 wire (NPN)	5V, 12V	—	H7LF	—	F7LF	●	●	○	—	—				
	Latch with diagnostic output (2 color)			—	—	—	—	—	—	—	—	—	—					

\* Lead wire length 0.5m..... e.g.) C73C 5m.....Z e.g.) C73CZ  
3m.....L C73CL None.....N C73CN

\* Solid state switches marked with "○" are manufactured upon receipt of order.

\*\* "D-A79W" cannot be mounted on bore size ø10 cylinder with air cushion.

### Part No. of Cylinder with Built-in Magnet

Symbol "A" (rail mounting) or "B" (band mounting) should be suffixed to the part No. of the cylinder with auto switch.

Ex.	Rail mounting	CDJ2KB16-60-A
	Band mounting	CDJ2KB10-45-B

# Non-rotating Rod: Double Acting Single Rod *Series CJ2K*

A cylinder in which the rod does not rotate because of its hexagonal shape.

## Non-rotating accuracy

ø10: ±1.5°, ø16: ±1°

Can operate without lubrication.

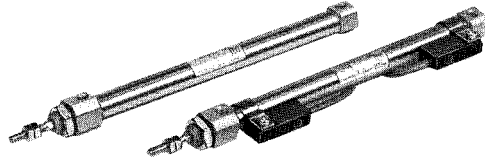

## JIS symbol

Double acting/Single rod

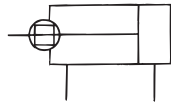

## Port Location on Head Cover

Either perpendicular to the cylinder axis or in-line with the cylinder axis is available for basic style.

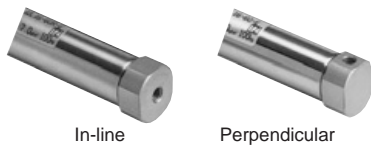

## ⚠ Precautions

Be sure to read before handling. Refer to p.0-39 to 0-46 for Safety Instructions and common precautions.

## ⚠ Caution

### Mounting

- ① During installation, secure the rod cover and tighten by applying an appropriate tightening force to the retaining nut or to the rod cover body. If the head cover is secured or the head cover body is tightened, the cover could rotate, leading to a deviation.
- ② Tighten the retaining screws to an appropriate tightening torque within the range given below.  
ø10: 10.8 to 11.8Nm, ø16: 20 to 21Nm
- ③ In the case of the non-rotating cylinder, do not operate it in such a way that rotational torque would be applied to the piston rod. If rotational torque is applied, the non-rotating guide will become deformed, thus affecting the non-rotating accuracy.
- ④ To screw a bracket or a nut onto the threaded portion at the tip of the piston rod by placing a wrench over the parallel section of the piston rod, make sure to retract the piston rod entirely, and use the portion of the rod that protrudes. To tighten, take precautions to prevent the tightening torque from being applied to the non-rotating guide.
- ⑤ To remove and install the snap ring for the knuckle pin or the clevis pin, use an appropriate pair of pliers (tool for installing a C type snap ring). In particular, use a pair of ultra-mini pliers such as the Super Tool CSM-07A for removing and installing the snap rings on the ø10 cylinder.
- ⑥ In the case of the auto switch rail mounting, do not remove the rail that is mounted. Because the retaining screws extend into the cylinder, this could lead to an air leak.

## Specifications

Action	Double acting/Single rod	
Fluid	Air	
Proof pressure	1.05MPa	
Max. operating pressure	0.7MPa	
Min. operating pressure	0.06MPa	
Ambient and fluid temperature	Without auto switch: -10°C to 70°C, With auto switch: -10°C to 60°C*	
Cushion	Rubber bumper	
Lubrication	Non-lube	
Thread tolerance	JIS class 2	
Stroke tolerance	+1.0 0	
Non-rotating accuracy	ø10	±1.5°
	ø16	±1°
Mounting	Basic, Axial foot, Front flange, Double clevis	
Piston speed	50 to 750mm/s	
Allowable kinetic energy	ø10	0.035J
	ø16	0.090J

\* No freezing

## Standard Stroke

Bore size	Standard stroke (mm)
10	15, 30, 45, 60, 75, 100, 125, 150
16	15, 30, 45, 60, 75, 100, 125, 150, 175, 200

## Minimum Strokes for Auto Switches Mounting

• Refer to p.1.3-3.

## Mounting Accessories/Refer to p.1.3-12 for details.

Mounting		Basic	Axial foot	Front flange	Double clevis*
Standard	Mounting nut	●	●	●	—
	Rod end nut	●	●	●	●
	Clevis pin	—	—	—	●
Option	Single knuckle joint	●	●	●	●
	Double knuckle joint*	●	●	●	●
	T bracket	—	—	—	●

\* Double clevis or double knuckle joint is packaged with pins and rings.

CJ1

CJP

CJ2

CM2

C85

CG1

MB

C95

CA1

CS1

# Series CJ2K

## Weight

(g)

Bore size (mm)		10	16
Basic weight*		24	55
Additional weight for each 15 of stroke		4	6.5
Mounting bracket weight	Axial foot	20	20
	Front flange	15	15
	Double clevis** (with pins)	4	10

\* This basic weight includes weights of mounting nut and rod end nut.

\*\* The mounting nut is not attached to the double clevis style, so the mounting nut weight is already reduced.

Calculation example: CJ2KL10-45

- Basic weight: 24 (ø10)
- Additional weight: 4/15 stroke
- Cylinder stroke: 45 stroke
- Mounting bracket weight: 20 (Axial foot)  
24+4/15 X 45+20=56g

## ⚠ Caution

### Handling

#### <Mounting>

• Avoid using the air cylinder in such a way that rotational torque would be applied to the piston rod because this will deform the non-rotating guide, thus affecting the non-rotating accuracy. Refer to the table below for the approximate values of the allowable range of rotational torque.

Allowable rotational torque Nm	ø10	ø16
	0.02	0.04

- Operate the cylinder in such a way that the load to the piston rod is always applied in the axial direction.
- To screw a bracket onto the threaded portion at the tip of the piston rod, make sure to retract the piston rod entirely, and place a wrench over the flat portion of the rod that protrudes. To tighten, take precautions to prevent the tightening torque from being applied to the non-rotating guide.

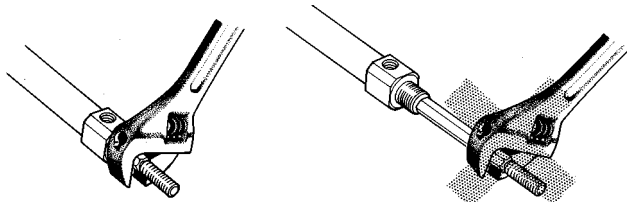

## Construction (The cylinder cannot be disassembled.)

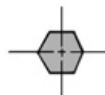
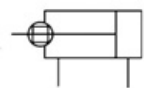

Rod cross section

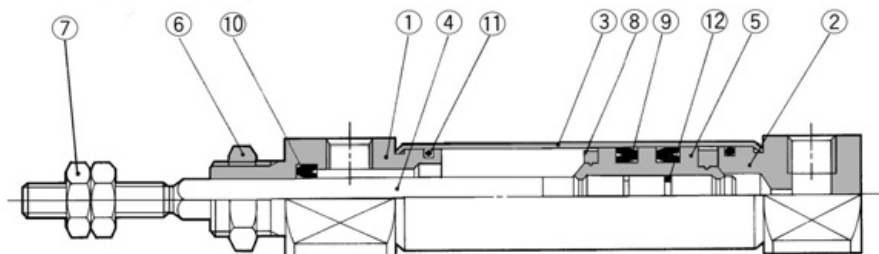

## Component Parts

No.	Description	Material	Note
①	Rod cover	Aluminum alloy	White anodized
②	Head cover	Aluminum alloy	White anodized
③	Cylinder tube	Stainless steel	
④	Piston rod	Stainless steel	
⑤	Piston	Brass	
⑥	Mounting nut	Brass	Nickel plated

## Mounting Bracket Part No.

Mounting bracket	Bore size (mm)	
	10	16
Foot	CJ-L016B	CJK-L016B
Flange	CJ-F016B	CJK-F016B
T bracket*	CJ-T010B	CJ-T016B

\* T bracket is used with double clevis (D).

## Auto Switch Mounting Bracket Part No. (Band mounting)

Bore size (mm)	Bracket part No.	Note
10	BJ2-010	Common use to all of D-C7, C8 and D-H7
16	BJ2-016	

## Copper Free

20-CJ2K **Mounting** **Bore size** **Stroke** **Port location on head cover**

- Copper free

To eliminate influences of copper ions or halogen ions during CRT manufacturing processes, copper and fluorine materials are not used as component parts.

## Specifications

Action	Double acting/Single rod	
Max. operating pressure	0.7MPa	
Min. operating pressure	0.06MPa	
Cushion	Rubber bumper (standard)	
Rod non-rotating accuracy	ø10	±1.5°
	ø16	±1°
Standard stroke (mm)	Same as the standard (Refer to p.1.3-31.)	
Auto switch	Possible to be mounted	
Mounting	Basic, Axial foot, Front flange, Double clevis	

Note) A set of stainless steel mounting screws "BBA4" is attached. (A switch mounting band is not attached. Please order the band separately.) "BBA4" screws are used for D-C7/C8/H7. "D-H7BAL" switch is set on the cylinder with the screws above when shipped. Also, when a switch only is shipped, "BBA4" screws are attached.



# Non-rotating Rod: Double Acting Single Rod *Series CJ2K*

## Basic (B)

**CJ2KB** Bore size Stroke Port location on head cover

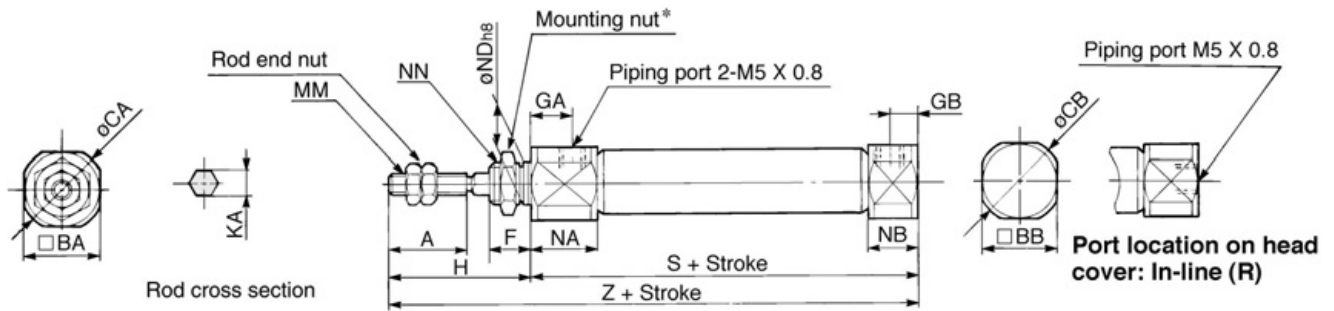

\* Refer to p.1.3-12 for details of the mounting nut. (SNJ-016B for  $\varnothing 10$ , SNKJ-016B for  $\varnothing 16$ )

Bore	A	BA	BB	CA	CB	F	GA	GB	H	KA	MM	NA	NB	NDh8	NN	S	Z
10	15	15	12	17	14	8	8	5	28	4.2	M4 X 0.7	12.5	9.5	10 <sup>0</sup> <sub>-0.022</sub>	M10 X 1.0	46	74
16	15	18	18	20	20	8	8	5	28	5.2	M5 X 0.8	12.5	9.5	12 <sup>0</sup> <sub>-0.027</sub>	M12 X 1.0	47	75

## Axial Foot (L)

**CJ2KL** Bore size Stroke Port location on head cover

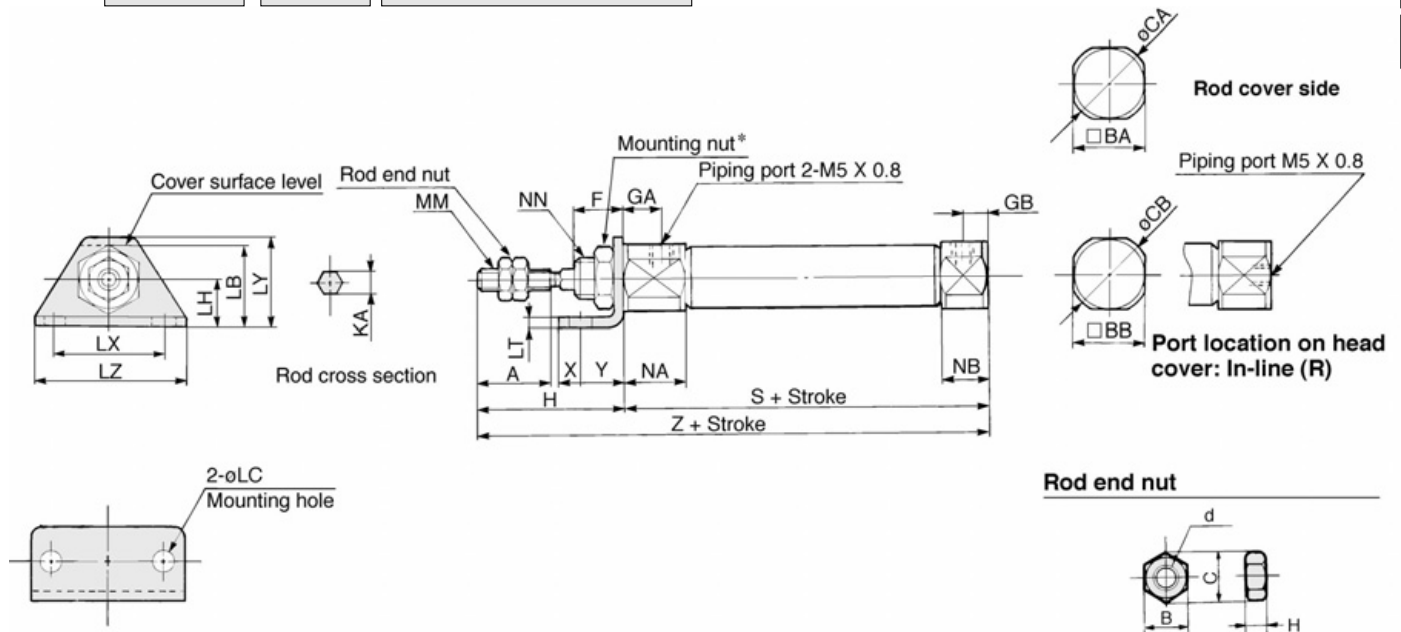

Material: Iron

Part No.	Bore	B	C	d	H
NTJ-010A	10	7	8.1	M4 X 0.7	3.2
NTJ-015A	16	8	9.2	M5 X 0.8	4

\* Refer to p.1.3-12 for details of the mounting nut. (SNJ-016B for  $\varnothing 10$ , SNKJ-016B for  $\varnothing 16$ )

Bore	A	BA	BB	CA	CB	F	GA	GB	H	KA	LB	LC	LH	LT	LX	LY	LZ	MM	NA	NB	NN	X	Y	S	Z
10	15	15	12	17	14	8	8	5	28	4.2	21.5	5.5	14	2.3	33	25	42	M4 X 0.7	12.5	9.5	M10 X 1.0	6	9	46	74
16	15	18	18	20	20	8	8	5	28	5.2	23	5.5	14	2.3	33	25	42	M5 X 0.8	12.5	9.5	M12 X 1.0	6	9	47	75

# Series CJ2K

## Front Flange (F)

CJ2KF Bore size Stroke Port location on head cover

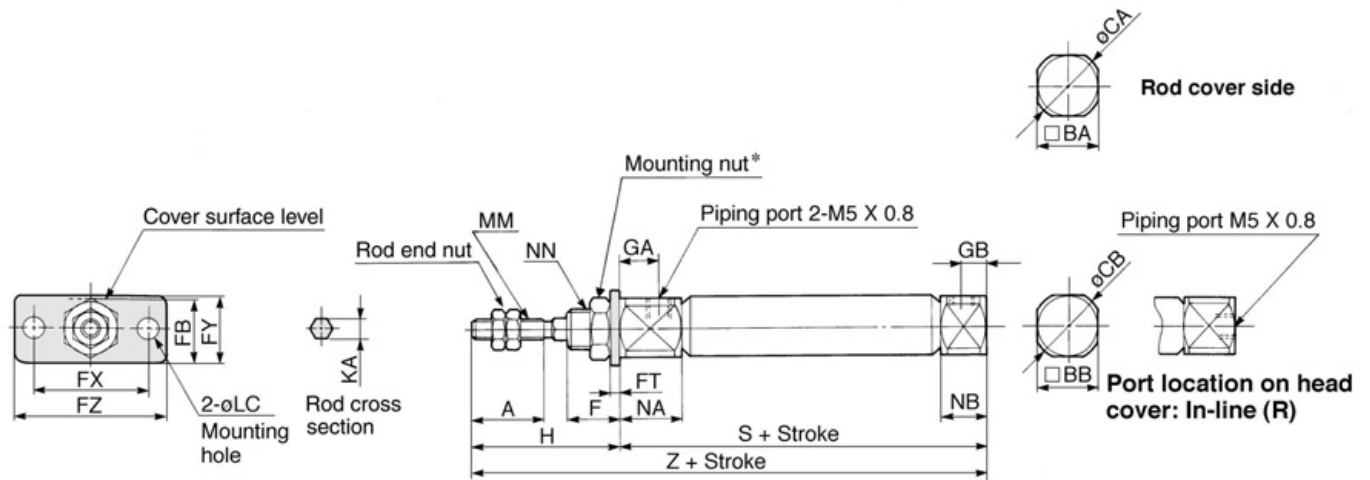

\* Refer to p.1.3-12 for details of the mounting nut. (SNJ-016B for  $\phi 10$ , SNKJ-016B for  $\phi 16$ )

Bore	A	BA	BB	CA	CB	F	FB	FC	FT	FX	FY	FZ	GA	GB	H	KA	MM	NA	NB	NN	S	Z
10	15	15	12	17	14	8	17.5	5.5	2.3	33	20	42	8	5	28	4.2	M4 X 0.7	12.5	9.5	M10 X 1.0	46	74
16	15	18	18	20	20	8	19	5.5	2.3	33	20	42	8	5	28	5.2	M5 X 0.8	12.5	9.5	M12 X 1.0	47	75

## Double Clevis (D)

CJ2KD Bore size Stroke

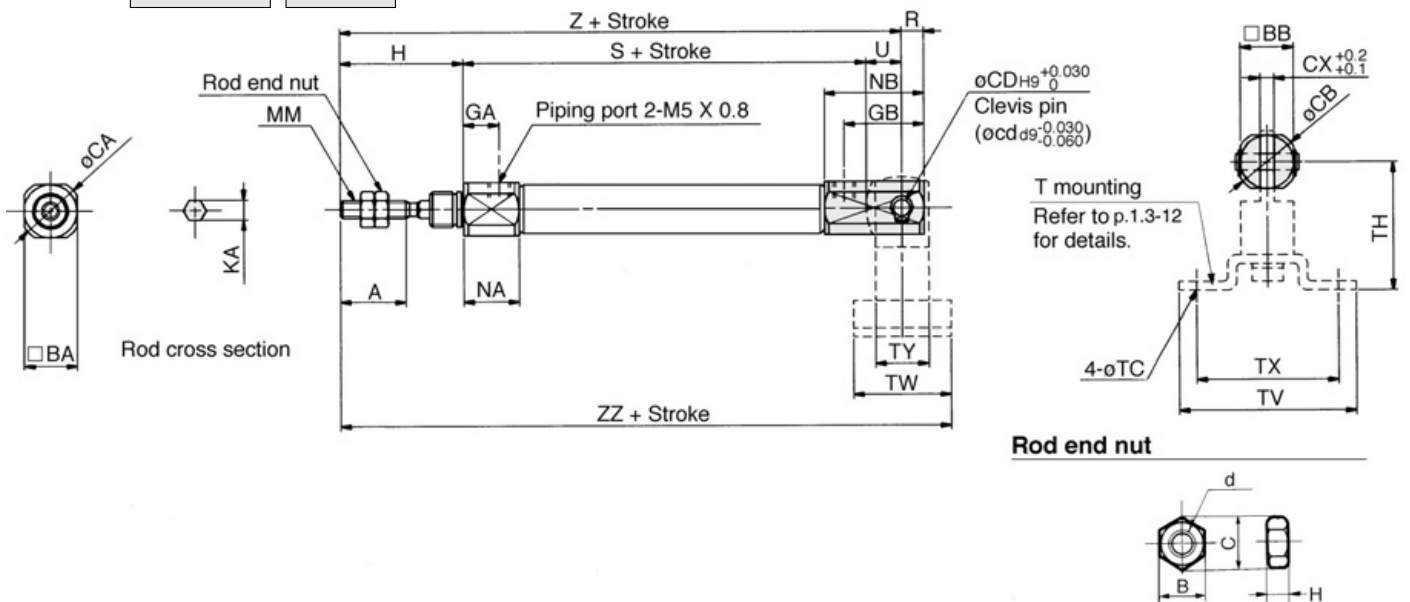

\* Clevis pins and set rings are attached.

Bore	A	BA	BB	CA	CB	CD(cd)	CX	GA	GB	H	KA	MM	NA	NB	R	S	U	Z	ZZ
10	15	15	12	17	14	3.3	3.2	8	18	28	4.2	M4 X 0.7	12.5	22.5	5	46	8	82	93
16	15	18	18	20	20	5	6.5	8	23	28	5.2	M5 X 0.8	12.5	27.5	8	47	10	85	99

### T mounting dimensions (mm)

Bore	TC	TH	TV	TW	TX	TY
10	4.5	29	40	22	32	12
16	5.5	35	48	28	38	16

Material: Iron

Part No.	Bore	B	C	d	H
NTJ-010A	10	7	8.1	M4 X 0.7	3.2
NTJ-015A	16	8	9.2	M5 X 0.8	4

# Non-rotating Rod: Single Acting Spring Return/Extend

# Series CJ2K

ø10, ø16

## How to Order

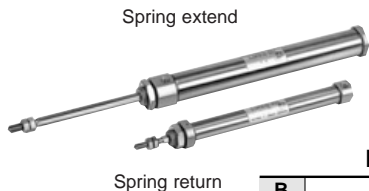

Bore size	
10	10mm
16	16mm

Mounting	
B	Basic
L	Axial foot
F	Front flange
D	Double clevis

Standard stroke (mm)	
ø10	15, 30, 45, 60
ø16	15, 30, 45, 60, 75, 100, 125, 150

Action	
S	Single acting/Spring return
T	Single acting/Spring extend

**Standard**

**With auto switch**

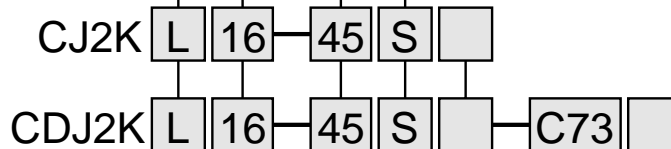

With auto switch  
(Built-in magnet)

Port location on head cover	
Symbol	Port location on head cover
—	Perpendicular
R	In-line

\* Refer to p.1.3-31 for the configuration.  
\* Not applicable to single acting/spring extend (T).

Number of switches	
—	2
S	1
n	n

\* Refer to the table below for selecting applicable auto switches.  
\* If requiring a built-in-magnet cylinder without an auto switch, refer to the model number example below.

- CJ1
- CJP
- CJ2**
- CM2
- C85
- CG1
- MB
- C95
- CA1
- CS1

### Applicable Auto Switches/Refer to p.5.3-2 for further information on auto switch.

Style	Special function	Electrical entry	Indicator	Wiring (Output)	Load voltage		Auto switch model**		Lead wire* (m)				Applicable load										
					DC	AC	Band	Rail		0.5 (-)	3 (L)	5 (Z)		None (N)									
								Perp.	In-line														
Reed switch	—	Grommet	Yes	3 wire (NPN)	—	5V	—	C76	—	A76H	●	●	—	—	IC								
											24V	—	—	—		—	●	●	—	—			
																	12V	100V	C73	A73	A73H	●	●
		Connector	No	2 wire	24V	—	5V, 12V ≤100V	—	C80	A80	A80H	●	●	—	—	IC							
												12V	—	C73C	A73C		—	●	●	●	●		
												5V, 12V ≤24V	—	C80C	A80C		—	●	●	●	●		
Diagnostic indication (2 color)	—	Grommet	Yes	—	—	—	—	A79W	—	—	●	●	—	—									
Solid state switch	—	Grommet	Yes	3 wire (NPN)	5V, 12V	—	H7A1	F7NV	F79	●	●	○	—	IC									
										3 wire (PNP)	—	—	—		—	●	●	○	—				
																12V	—	H7A2	F7PV	F7P	●	●	○
		Connector	No	2 wire	24V	—	12V	—	H7B	F7BV	J79	●	●	○	—	Relay PLC							
												—	—	H7C	J79C		—	●	●	●	●		
												5V, 12V	—	H7NW	F7NWV		F79W	●	●	○	—		
	Diagnostic indication (2 color)	Yes	Grommet	Yes	3 wire (NPN)	5V, 12V	—	H7PW	—	F7PW	●	●	○	—	IC								
											3 wire (PNP)	—	—	—		—	●	●	○	—			
																	12V	—	H7BW	H7BWV	J79W	●	●
	Water resistant (2 color)	No	Grommet	No	2 wire	24V	—	H7BA	—	F7BA	—	●	○	—	—								
											With timer	—	—	—		—	—	—	F7NT	—	●	○	—
																	5V, 12V	—	H7NF	—	F79F	●	●
With diagnostic output (2 color)	No	Grommet	No	4 wire (NPN)	—	—	H7LF	—	F7LF	●	●	○	—	—									
										Latch with diagnostic output (2 color)	—	—	—		—	—	—	—	—	—	—		
																—	—	—	—	—	—	—	—

\* Lead wire length 0.5m..... e.g.) C73C 5m.....Z e.g.) C73CZ  
3m.....L C73CL None.....N C73CN

\* Solid state switches marked with "○" are manufactured upon receipt of order.

\*\* "D-A79W" cannot be mounted on bore size ø10 cylinder with air cushion.

### Part No. of Cylinder with Built-in Magnet

Symbol "A" (rail mounting) or "B" (band mounting) should be suffixed to the part No. of the cylinder with auto switch.

Ex.	Mounting	Part No.
—	Rail mounting	CDJ2KB16-60S-A
—	Band mounting	CDJ2KB10-45S-B

# Series CJ2K

A cylinder in which the rod does not rotate because of its hexagonal shape.

## Non-rotating accuracy

ø10: ±1.5°, ø16: ±1°

Can operate without lubrication.

Auto switch can also be mounted.

It can be equipped with auto switches to simplify the detection of the stroke position of the cylinder.

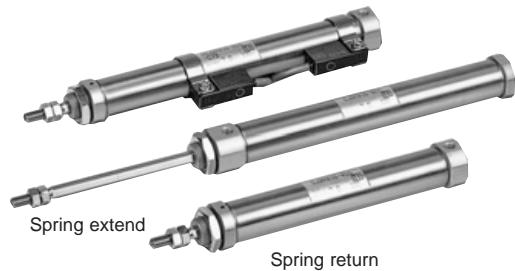

## JIS symbol

Single acting/  
Spring return

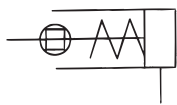

Single acting/  
Spring extend

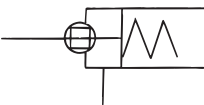

## Precautions

Be sure to read before handling.  
Refer to p.0-39 to 0-46 for Safety  
Instructions and common precautions.

## Caution

### Mounting

- ① During installation, secure the rod cover and tighten by applying an appropriate tightening force to the retaining nut or to the rod cover body. If the head cover is secured or the head cover body is tightened, the cover could rotate, leading to a deviation.
- ② Tighten the retaining screws to an appropriate tightening torque within the range given below.  
ø10: 10.8 to 11.8Nm, ø16: 20 to 21Nm
- ③ In the case of the single acting cylinder, do not operate it in such a way that a load would be applied during the retraction of the piston rod of the spring return style, or during the extension of the piston rod of the spring extend style. The spring that is built into the cylinder provides only enough force to retract the piston rod. Thus, if a load is applied, the piston rod will not be able to retract to the end of the stroke.
- ④ In the case of the single acting cylinder, a breather hole is provided in the cover surface. Make sure not to block this hole during installation, as this could lead to a malfunction.
- ⑤ In the case of the non-rotating cylinder, do not operate it in such a way that rotational torque would be applied to the piston rod. If rotational torque is applied, the non-rotating guide will become deformed, thus affecting the non-rotating accuracy. (Refer to p.1.3-32.)
- ⑥ To screw a bracket or a nut onto the threaded portion at the tip of the piston rod by placing a wrench over the parallel section of the piston rod, make sure to retract the piston rod entirely, and use the portion of the rod that protrudes. To tighten, take precautions to prevent the tightening torque from being applied to the non-rotating guide. (Refer to p.1.3-32.)
- ⑦ To remove and install the snap ring for the knuckle pin or the clevis pin, use an appropriate pair of pliers (tool for installing a C snap ring). In particular, use a pair of ultra-mini pliers such as the Super Tool CSM-07A for removing and installing the snap rings on the ø10 cylinder.
- ⑧ In the case of auto switch rail mounting, do not remove the rail that is mounted. Because the retaining screws extend into the cylinder, this could lead to an air leak.

## Specifications

Action	Single acting/Spring return	Single acting/Spring extend
Fluid	Air	
Proof pressure	1.05MPa	
Max. operating pressure	0.7MPa	
Min. operating pressure	0.15MPa	
Ambient and fluid temperature	Without auto switch: -10°C to 70°C, With auto switch: -10°C to 60°C*	
Cushion	Rubber bumper (Standard equipment)	
Lubrication	Non-lube	
Thread tolerance	JIS class 2	
Stroke tolerance	+1.0 0	
Non-rotating accuracy	ø10	±1.5°
	ø16	±1°
Piston speed	50 to 750mm/s	
Allowable kinetic energy	ø10	0.035J
	ø16	0.090J

\* No freezing

## Standard Stroke

(mm)

Bore size	Standard stroke
10	15, 30, 45, 60
16	15, 30, 45, 60, 75, 100, 125, 150

## Spring Force

(N)

Bore size (mm)	Extended position	Retracted position
10	6.86	3.53
16	14.2	6.86

## Minimum Strokes for Auto Switches Mounting

- Refer to p.1.3-3.

## Mounting Accessories/Refer to p.1.3-12 for details.

Mounting		Basic	Axial foot	Front flange	Double clevis*
Standard	Mounting nut	●	●	●	—
	Rod end nut	●	●	●	●
	Clevis pin	—	—	—	●
Option	Single knuckle joint	●	●	●	●
	Double knuckle joint*	●	●	●	●
	T bracket	—	—	—	●

\* Double clevis or double knuckle joint is packaged with pins and rings.



## Made to Order

Refer to p.5.4-1 for made to order products of series CJ2K.

# Non-rotating Rod: Single Acting Spring Return/Extend *Series CJ2K*

## Weight/Spring Return ( ): Spring extend (g)

	Bore size (mm)		
	10	16	
Basic weight**	15 Stroke	28 (28)	63 (64)
	30 Stroke	35 (34)	80 (80)
	45 Stroke	44 (43)	102 (100)
	60 Stroke	53 (51)	124 (121)
	75 Stroke	—	145 (140)
	100 Stroke	—	188 (178)
	125 Stroke	—	224 (212)
	150 Stroke	—	250 (236)
Mounting bracket weight	Axial foot	20	20
	Front flange	15	15
	Double clevis* (with pins)	4	10

\*\* This basic weight includes weights of mounting nut and rod end nut.

\* The mounting nut is not attached to the double clevis style, so the mounting nut weight is already reduced.

Calculation example: CJ2KL10-45S

• Basic weight:.....44 (ø10-45 stroke)

• Mounting bracket weight:.....20 (Axial foot)  
44 + 20 = 64g

## Mounting Bracket Part No.

Mounting bracket	Bore size (mm)	
	10	16
Foot	CJ-L016B	CJK-L016B
Flange	CJ-F016B	CJK-F016B
T bracket*	CJ-T010B	CJ-T016B

\* T mounting is used with double clevis (D).

## Copper Free

**20-CJ2K** Mounting Bore size Stroke Action Port location on head cover

• Copper free

To eliminate influences of copper ions or halogen ions during CRT manufacturing processes, copper and fluorine materials are not used as component parts.

## Specifications

Action	Single acting/Spring return, Spring extend
Fluid	Air
Bore size (mm)	ø10, ø16
Max. operating pressure	0.7MPa
Min. operating pressure	0.15MPa
Cushion	Rubber bumper (standard equipment)
Rod non-rotating accuracy	ø10: ±1.5°, ø16: ±1°
Standard stroke (mm)	Same as the standard (Refer to p.1.3-36.)
Auto switch	Possible to be mounted
Mounting	Basic, Axial foot, Front flange, Double clevis

## Auto Switch Mounting Bracket Part No. (Band mounting)

Bore size (mm)	Bracket part No.	Note
10	BJ2-010	Common use to all of D-C7, C8 and D-H7
16	BJ2-016	



Note) A set of stainless steel mounting screws "BBA4" is attached. (A switch mounting band is not attached. Please order the band separately.) "BBA4" screws are used for D-C7/C8/H7. "D-H7BAL" switch is set on the cylinder with the screws above when shipped.

## Construction (The cylinder cannot be disassembled.)

### Single acting/Spring return

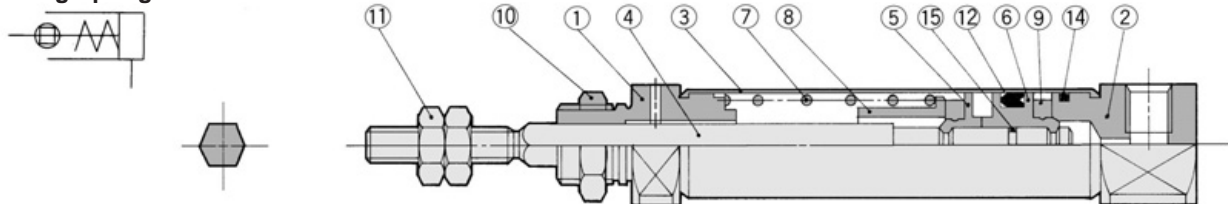

### Single acting/Spring extend

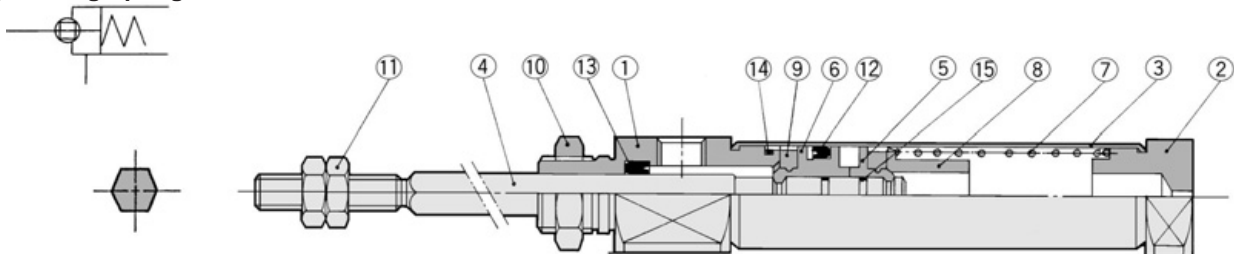

## Component Parts

No.	Description	Material	Note
①	Rod cover	Aluminum alloy	White anodized
②	Head cover	Aluminum alloy	White anodized
③	Cylinder tube	Stainless steel	
④	Piston rod	Stainless steel	
⑤	Piston A	Brass	
⑥	Piston B	Brass	
⑦	Return spring	Piano wire	
⑧	Spring seat	Brass	

No.	Description	Material	Note
⑨	Bumper	Urethane	
⑩	Mounting nut	Brass	Nickel plated
⑪	Rod end nut	Rolled steel	Nickel plated
⑫	Piston seal	NBR	
⑬	Rod seal	NBR	
⑭	Tube gasket	NBR	
⑮	Piston gasket	NBR	

# Series CJ2K

## Single Acting/Spring Return: Basic (B)

CJ2KB   S

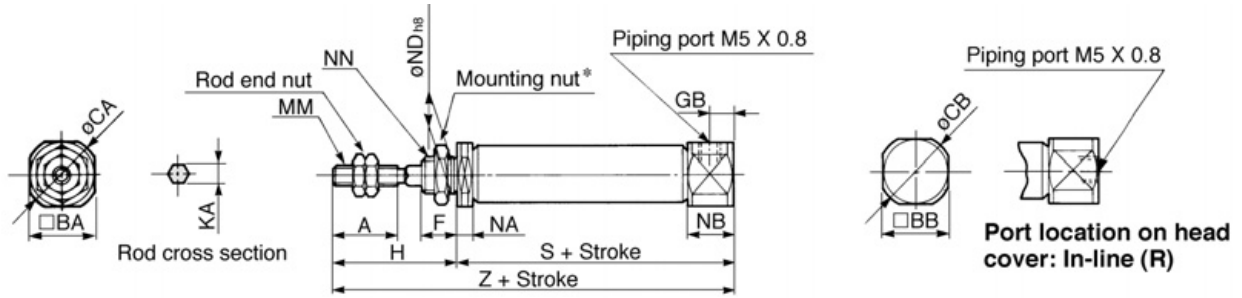

\* Refer to p.1.3-12 for details of the mounting nut. (SNJ-016B for  $\phi 10$ , SNKJ-016B for  $\phi 16$ ) (mm)

Bore	A	BA	BB	CA	CB	F	GB	H	KA	MM	NA	NB	NDh8	NN
10	15	15	12	17	14	8	5	28	4.2	M4 X 0.7	5.5	9.5	10 <sub>-0.022</sub>	M10 X 1.0
16	15	18	18	20	20	8	5	28	5.2	M5 X 0.8	5.5	9.5	12 <sub>-0.027</sub>	M12 X 1.0

### Dimensions by stroke

Bore	Symbol	S								Z							
		Stroke	5 to 15	16 to 30	31 to 45	46 to 60	61 to 75	76 to 100	101 to 125	126 to 150	5 to 15	16 to 30	31 to 45	46 to 60	61 to 75	76 to 100	101 to 125
10		45.5	53	65	77	—	—	—	—	73.5	81	93	105	—	—	—	—
16		45.5	54	66	78	84	108	126	138	73.5	82	94	106	112	136	154	166

## Single Acting/Spring Return: Axial Foot (L)

CJ2KL   S

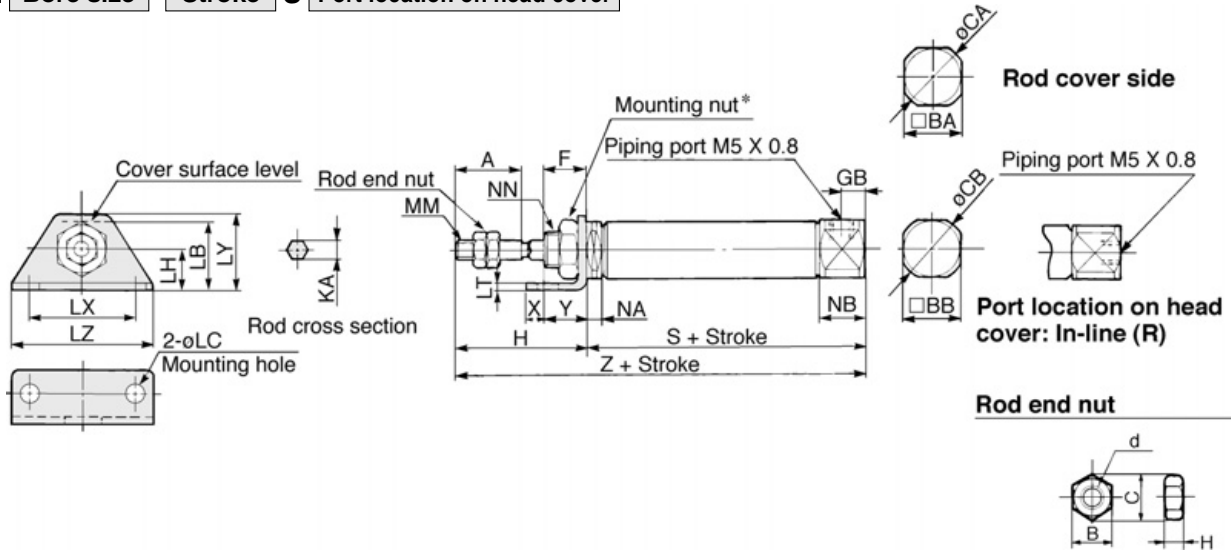

Part No.	Bore	B	C	Material: Iron	
				d	H
NTJ-010A	10	7	8.1	M4 X 0.7	3.2
NTJ-015A	16	8	9.2	M5 X 0.8	4

\* Refer to p.1.3-12 for details of the mounting nut. (SNJ-016B for  $\phi 10$ , SNKJ-016B for  $\phi 16$ ) (mm)

Bore	A	BA	BB	CA	CB	F	GB	H	KA	LB	LC	LH	LT	LX	LY	LZ	MM	NA	NB	NN	X	Y
10	15	15	12	17	14	8	5	28	4.2	21.5	5.5	14	2.3	33	25	42	M4 X 0.7	5.5	9.5	M10 X 1.0	6	9
16	15	18	18	20	20	8	5	28	5.2	23	5.5	14	2.3	33	25	42	M5 X 0.8	5.5	9.5	M12 X 1.0	6	9

### Dimensions by stroke

Bore	Symbol	S								Z							
		Stroke	5 to 15	16 to 30	31 to 45	46 to 60	61 to 75	76 to 100	101 to 125	126 to 150	5 to 15	16 to 30	31 to 45	46 to 60	61 to 75	76 to 100	101 to 125
10		45.5	53	65	77	—	—	—	—	73.5	81	93	105	—	—	—	—
16		45.5	54	66	78	84	108	126	138	73.5	82	94	106	112	136	154	166

# Non-rotating Rod: Single Acting Spring Return/Extend *Series CJ2K*

## Single Acting/Spring Return: Front Flange (F)

CJ2KF   S

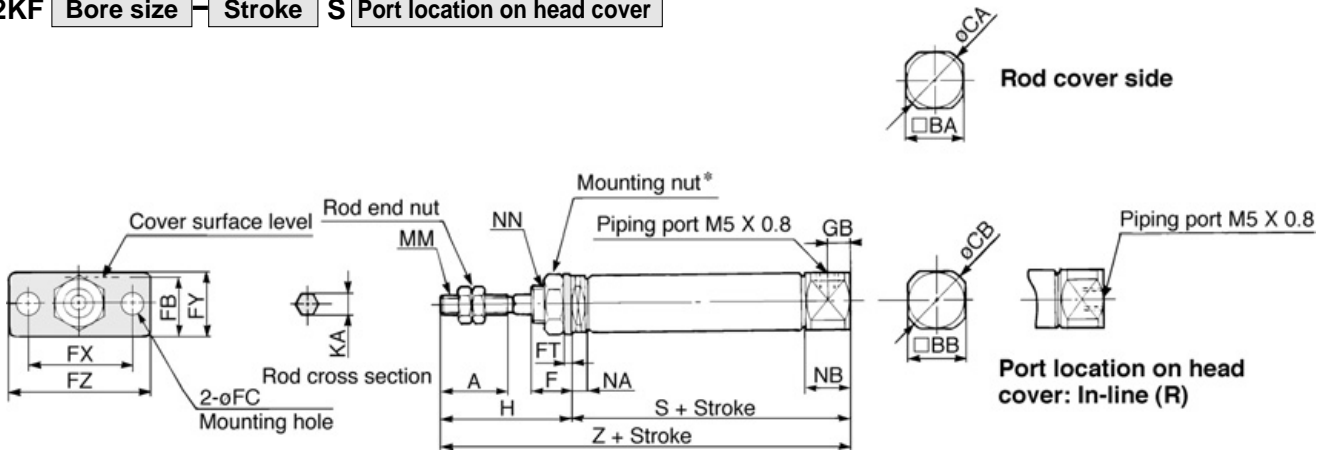

\* Refer to p.1.3-12 for details of the mounting nut. (SNJ-016B for ø10, SNKJ-016B for ø16) (mm)

Bore	A	BA	BB	CA	CB	F	FB	FC	FT	FX	FY	FZ	GB	H	KA	MM	NA	NB	NN
10	15	15	12	17	14	8	17.5	5.5	2.3	33	20	42	5	28	4.2	M4 X 0.7	5.5	9.5	M10 X 1.0
16	15	18	18	20	20	8	19	5.5	2.3	33	20	42	5	28	5.2	M5 X 0.8	5.5	9.5	M12 X 1.0

### Dimensions by stroke

Bore	Symbol Stroke	S								Z							
		5 to 15	16 to 30	31 to 45	46 to 60	61 to 75	76 to 100	101 to 125	126 to 150	5 to 15	16 to 30	31 to 45	46 to 60	61 to 75	76 to 100	101 to 125	126 to 150
10		45.5	53	65	77	—	—	—	—	73.5	81	93	105	—	—	—	—
16		45.5	54	66	78	84	108	126	138	73.5	82	94	106	112	136	154	166

## Single Acting/Spring Return: Double Clevis (D)

CJ2KD   S

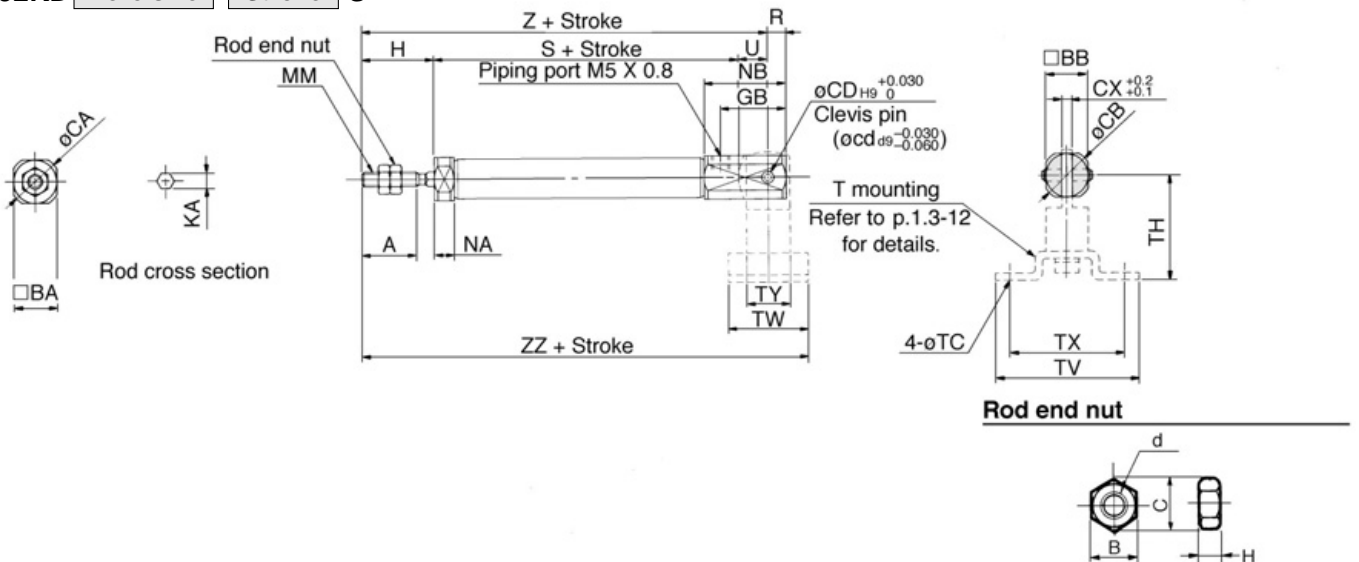

\* Clevis pins and set rings are attached.

Bore	A	BA	BB	CA	CB	CD(cd)	CX	GB	H	KA	MM	NA	NB	R	U
10	15	12	12	14	14	3.3	3.2	18	20	4.2	M4 X 0.7	5.5	22.5	5	8
16	15	18	18	20	20	5	6.5	23	20	5.2	M5 X 0.8	5.5	27.5	8	10

Material: Iron

Part No.	Bore	B	C	d	H
NTJ-010A	10	7	8.1	M4 X 0.7	3.2
NTJ-015A	16	8	9.2	M5 X 0.8	4

### Dimensions by stroke

Bore	Symbol Stroke	S								Z								ZZ							
		5 to 15	16 to 30	31 to 45	46 to 60	61 to 75	76 to 100	101 to 125	126 to 150	5 to 15	16 to 30	31 to 45	46 to 60	61 to 75	76 to 100	101 to 125	126 to 150	5 to 15	16 to 30	31 to 45	46 to 60	61 to 75	76 to 100	101 to 125	126 to 150
10		45.5	53	65	77	—	—	—	—	73.5	81	93	105	—	—	—	—	84.5	92	104	116	—	—	—	—
16		45.5	54	66	78	84	108	126	138	75.5	84	96	108	114	138	156	168	89.5	98	110	122	128	152	170	182

### T mounting dimensions

Bore	TC	TH	TV	TW	TX	TY
10	4.5	29	40	22	32	12
16	5.5	35	48	28	38	16

# Series CJ2K

## Single Acting/Spring Extend: Basic (B)

CJ2KB   T

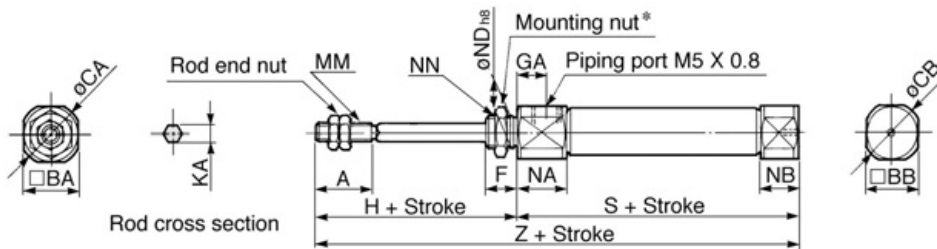

\* Refer to p.1.3-12 for details of the mounting nut. (SNJ-016B for ø10, SNKJ-016B for ø16) (mm)

Bore	A	BA	BB	CA	CB	F	GA	H	KA	MM	NA	NB	NDh8	NN
10	15	15	12	17	14	8	8	28	4.2	M4 X 0.7	12.5	5.5	10 <sub>-0.022</sub>	M10 X 1.0
16	15	18	18	20	20	8	8	28	5.2	M5 X 0.8	12.5	5.5	12 <sub>-0.027</sub>	M12 X 1.0

### Dimensions by stroke

Bore	Symbol Stroke	S								Z							
		5 to 15	16 to 30	31 to 45	46 to 60	61 to 75	76 to 100	101 to 125	126 to 150	5 to 15	16 to 30	31 to 45	46 to 60	61 to 75	76 to 100	101 to 125	126 to 150
10		48.5	56	68	80	—	—	—	—	76.5	84	96	108	—	—	—	—
16		48.5	57	69	81	87	111	129	141	76.5	85	97	109	115	139	157	169

## Single Acting/Spring Extend: Axial Foot (T)

CJ2KL   T

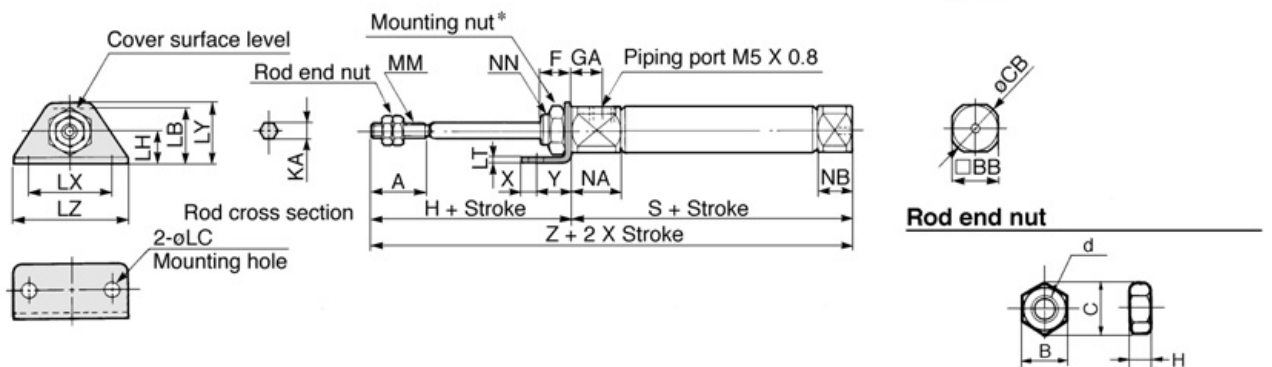

Material: Iron

Part No.	Bore	B	C	d	H
NTJ-010A	10	7	8.1	M4 X 0.7	3.2
NTJ-015A	16	8	9.2	M5 X 0.8	4

\* Refer to p.1.3-12 for details of the mounting nut. (SNJ-016B for ø10, SNKJ-016B for ø16) (mm)

Bore	A	BA	BB	CA	CB	F	GA	H	KA	LB	LC	LH	LT	LX	LY	LZ	MM	NA	NB	NN	X	Y
10	15	15	12	17	14	8	8	28	4.2	21.5	5.5	14	2.3	33	25	42	M4 X 0.7	12.5	5.5	M10 X 1.0	6	9
16	15	18	18	20	20	8	8	28	5.2	23	5.5	14	2.3	33	25	42	M5 X 0.8	12.5	5.5	M12 X 1.0	6	9

### Dimensions by stroke

Bore	Symbol Stroke	S								Z							
		5 to 15	16 to 30	31 to 45	46 to 60	61 to 75	76 to 100	101 to 125	126 to 150	5 to 15	16 to 30	31 to 45	46 to 60	61 to 75	76 to 100	101 to 125	126 to 150
10		48.5	56	68	80	—	—	—	—	76.5	84	96	108	—	—	—	—
16		48.5	57	69	81	87	111	129	141	76.5	85	97	109	115	139	157	169



# Non-rotating Rod: Single Acting Spring Return/Extend *Series CJ2K*

## Single Acting/Spring Extend: Front Flange (F)

CJ2KF Bore size Stroke T

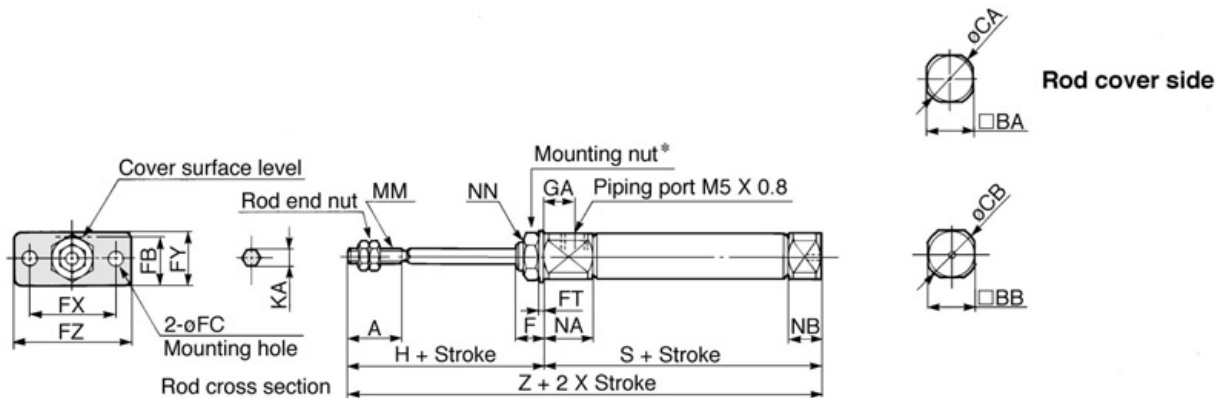

\* Refer to p.1.3-12 for details of the mounting nut. (SNJ-016B for ø10, SNKJ-016B for ø16) (mm)

Bore	A	BA	BB	CA	CB	F	FB	FC	FT	FX	FY	FZ	GA	H	KA	MM	NA	NB	NN
10	15	15	12	17	14	8	17.5	5.5	2.3	33	20	42	8	28	4.2	M4 X 0.7	12.5	5.5	M10 X 1.0
16	15	18	18	20	20	8	19	5.5	2.3	33	20	42	8	28	5.2	M5 X 0.8	12.5	5.5	M12 X 1.0

### Dimensions by stroke

Bore	Symbol	S								Z							
		5 to 15	16 to 30	31 to 45	46 to 60	61 to 75	76 to 100	101 to 125	126 to 150	5 to 15	16 to 30	31 to 45	46 to 60	61 to 75	76 to 100	101 to 125	126 to 150
10	Stroke	48.5	56	68	80	-	-	-	-	76.5	84	96	108	-	-	-	-
16	Stroke	48.5	57	69	81	87	111	129	141	76.5	85	97	109	115	139	157	169

## Single Acting/Spring Extend: Double Clevis (D)

CJ2KD Bore size Stroke T

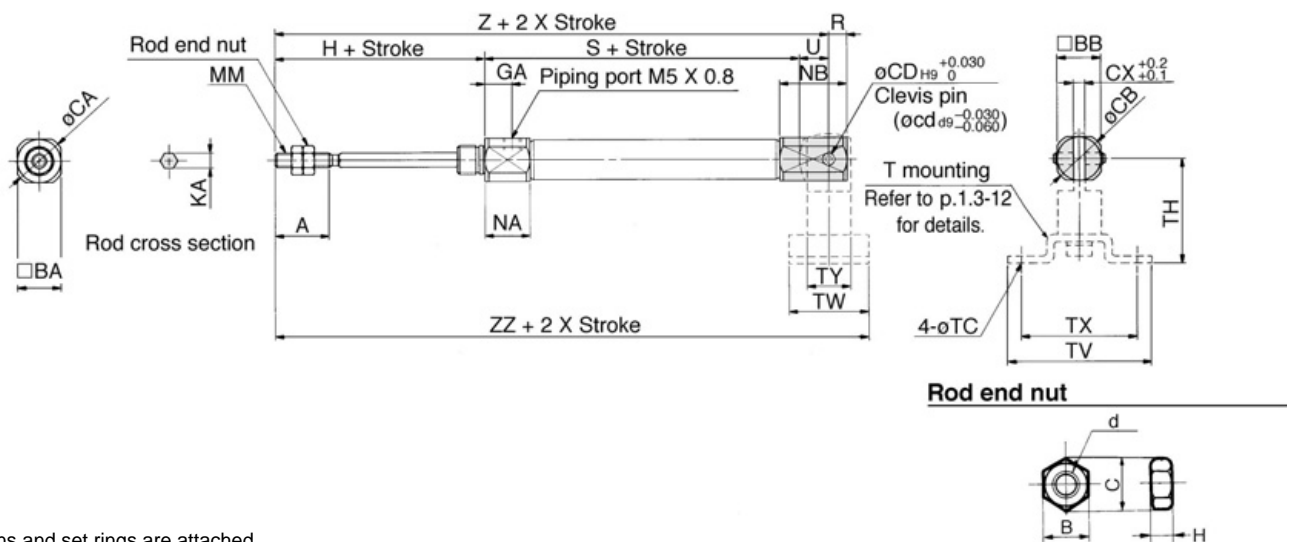

\* Clevis pins and set rings are attached.

(mm)

Bore	A	BA	BB	CA	CB	CD(cd)	CX	GA	H	KA	MM	NA	NB	R	U
10	15	15	12	17	14	3.3	3.2	8	28	4.2	M4 X 0.7	12.5	18.5	5	8
16	15	18	18	20	20	5	6.5	8	28	5.2	M5 X 0.8	12.5	23.5	8	10

Material: Iron

Part No.	Bore	B	C	d	H
NTJ-010A	10	7	8.1	M4 X 0.7	3.2
NTJ-015A	16	8	9.2	M5 X 0.8	4

### Dimensions by stroke

Bore	Symbol	S								Z								ZZ							
		5 to 15	16 to 30	31 to 45	46 to 60	61 to 75	76 to 100	101 to 125	126 to 150	5 to 15	16 to 30	31 to 45	46 to 60	61 to 75	76 to 100	101 to 125	126 to 150	5 to 15	16 to 30	31 to 45	46 to 60	61 to 75	76 to 100	101 to 125	126 to 150
10	Stroke	48.5	56	68	80	-	-	-	-	84.5	92	104	116	-	-	-	-	95.5	103	115	127	-	-	-	-
16	Stroke	48.5	57	69	81	87	111	129	141	86.5	95	107	119	125	149	167	179	100.5	109	121	133	139	163	181	193

### T mounting dimensions

Bore	TC	TH	TV	TW	TX	TY
10	4.5	29	40	22	32	12
16	5.5	35	48	28	38	16

# Built-in Speed Controller: Double Acting Single Rod

## Series CJ2Z



ø10, ø16

### How to Order

**Bore size**

10	10mm
16	16mm

**Mounting**

B	Basic
L	Axial foot
F	Front flange
D	Double clevis

**Standard stroke (mm)**

ø10	15, 30, 45, 60, 75, 100, 125, 150
ø16	15, 30, 45, 60, 75, 100, 125, 150, 175, 200

**Standard** CJ2Z L 16 60

**With auto switch** CDJ2Z L 16 60 C73

**Band mounting**

**Rail mounting**

**With auto switch**  
(Built-in magnet)

**Port location on head cover**

Symbol	Port location
—	Perpendicular
R	In-line

\* Refer to p.1.3-43 for the configuration.

**Auto switch**

\* Refer to the table below for selecting applicable auto switches.

\* If requiring a built-in-magnet cylinder without an auto switch, refer to the model number example below.

**Number of switches**

—	2
S	1
n	n

### Applicable Auto Switches/Refer to p.5.3-2 for further information on auto switch.

Style	Special function	Electrical entry	Indicator	Wiring (Output)	Load voltage		Auto switch model**		Lead wire* (m)				Applicable load									
					DC	AC	Band	Rail		0.5 (-)	3 (L)	5 (Z)	None (N)	IC	Relay PLC							
								Perp.	In-line													
Reed switch	—	Grommet	Yes	3 wire (NPN)	—	5V	—	C76	—	A76H	●	●	—	—	IC	—						
								—	—	200V	—	A72	A72H	●	●	—	—	—				
								Connector	No	2 wire	24V	5V, 12V	≤100V	C80	A80	A80H	●	●	—	—	IC	Relay PLC
												12V	—	C73C	A73C	—	●	●	●	●	—	
												5V, 12V	≤24V	C80C	A80C	—	●	●	●	●	—	
—	—	—	—	A79W	—	●	●	—	—	—												
Solid state switch	—	Grommet	Yes	3 wire (NPN)	5V, 12V	—	H7A1	F7NV	F79	●	●	○	—	IC	Relay PLC							
				3 wire (PNP)			H7A2	F7PV	F7P	●	●	○	—									
				Connector			No	2 wire	H7B	F7BV	J79	●	●	○		—						
									H7C	J79C	—	●	●	●		●	—					
									H7NW	F7NWV	F79W	●	●	○		—						
		Grommet	No	2 wire	24V	5V, 12V	—	H7PW	—	F7PW	●	●	○	—	IC							
						3 wire (NPN)	H7BW	H7BWV	J79W	●	●	○	—									
						3 wire (PNP)	—	—	—	—	—	—	—	—								
						Water resistant (2 color)	H7BA	—	F7BA	—	●	○	—	—								
						With timer	—	—	F7NT	—	●	○	—	—								
Grommet	Yes	3 wire (NPN)	5V, 12V	—	H7NF	—	F79F	●	●	○	—	IC										
					With diagnostic output (2 color)	H7LF	—	F7LF	●	●	○	—										
					Latch with diagnostic output (2 color)	—	—	—	—	—	—	—	—									

### Part No. of Cylinder with Built-in Magnet

Symbol "-A" (rail mounting) or "-B" (band mounting) should be suffixed to the part No. of the cylinder with auto switch.

Ex.	Rail mounting	CDJ2ZB16-60-A
	Band mounting	CDJ2ZB10-45-B

\* Lead wire length 0.5m..... e.g.) C73C 5m.....Z e.g.) C73CZ  
3m.....L C73CL None.....N C73CN

\* Solid state switches marked with "○" are manufactured upon receipt of order.

\*\* "D-A79W" cannot be mounted on bore size ø10 cylinder with air cushion.

# Built-in Speed Controller: Double Acting Single Rod *Series CJ2Z*

## Space saving air cylinder with built-in speed controller

Auto switch available



## JIS symbol

Double acting/single rod

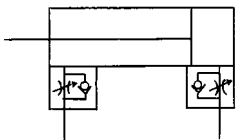

## Port Location on Head Cover

Either perpendicular to the cylinder axis or in-line with the cylinder axis is available for basic style.



In-line



Perpendicular

## ⚠ Precautions

Refer to p.1.3-3 before handling.

## Specifications

Action	Double acting/Single rod	
Fluid	Air	
Proof pressure	1.05MPa	
Max. operating pressure	0.7MPa	
Min. operating pressure	0.06MPa	
Ambient and fluid temperature	Without auto switch: -10°C to 70°C, With auto switch: -10°C to 60°C*	
Cushion	Rubber bumper (Standard equipment)	
Lubrication	Non-lube	
Thread tolerance	JIS class 2	
Stroke tolerance	+1.0 0	
Speed controller	Built-in	
Mounting	Basic, Axial foot, Front flange, Double clevis	
Piston speed	50 to 750mm/s	
Allowable kinetic energy	ø10	0.035J
	ø16	0.090J

\* No freezing

## Standard Stroke

Bore size	Standard stroke (mm)
10	15, 30, 45, 60, 75, 100, 125, 150
16	15, 30, 45, 60, 75, 100, 125, 150, 175, 200

## Minimum Strokes for Auto Switches Mounting

•Refer to p.1.3-3.

## Mounting Accessories/Refer to p.1.3-12 for details.

Mounting		Basic	Axial foot	Front flange	Double clevis*
Standard	Mounting nut	●	●	●	—
	Rod end nut	●	●	●	●
	Clevis pin	—	—	—	●
Option	Single knuckle joint	●	●	●	●
	Double knuckle joint*	●	●	●	●
	T bracket	—	—	—	●

\* Double clevis or double knuckle joint are packaged with pins and rings.

CJ1

CJP

CJ2

CM2

C85

CG1

MB

C95

CA1

CS1

# Series CJ2Z

## Weight

(g)

Bore size (mm)		10	16
Basic weight*		40	73
Additional weight for each 15 of stroke		4	6.5
Mounting bracket weight	Axial foot	8	20
	Front flange	5	15
	Double clevis** (with pins)	4	10

\* This basic weight includes weights of mounting nut and rod end nut.

\*\* The mounting nut is not attached to the double clevis style, so the mounting nut weight is already reduced.

Calculation example: CJ2ZL10-45

- Basic weight: 40 (ø10)
  - Additional weight: 4/15 stroke
  - Cylinder stroke: 45 stroke
  - Mounting bracket weight: 8 (Axial foot)
- $44+4/15 \times 45+8=60g$

## Mounting Bracket Part No.

Mounting bracket	Bore size (mm)	
	10	16
Foot	CJ-L010B	CJ-L016B
Flange	CJ-F010B	CJ-F016B
T bracket*	CJ-T010B	CJ-T016B

\* T bracket is used with double clevis (D).

## Auto Switch Mounting Bracket Part No. (Band mounting)

Bore size (mm)	Bracket part No.	Note
10	BJ2-010	Common use to all of D-C7, C8 and D-H7
16	BJ2-016	



Note) A set of stainless steel mounting screws "BBA4" is attached. (A switch mounting band is not attached. Please order the band separately.) "BBA4" screws are used for D-C7/C8/H7. "D-H7BAL" switch is set on the cylinder with the screws above when shipped. Also, when a switch only is shipped, "BBA4" screws are attached.

## Copper Free

20-CJ2Z    Mounting    Bore size    Stroke    Port location on head cover

• Copper free

To eliminate influences of copper ions or halogen ions during CRT manufacturing processes, copper and fluorine materials are not used as component parts.



## Specifications

Action	Double acting/Single rod
Bore size (mm)	ø10, ø16
Max. operating pressure	0.7MPa
Min. operating pressure	0.06MPa
Cushion	Rubber bumper (standard equipment)
Standard stroke (mm)	Same as the standard (Refer to p.1.3-43.)
Auto switch	Possible to be mounted
Mounting	Basic, Axial foot, Front flange, Double clevis

## Construction (The cylinder cannot be disassembled)

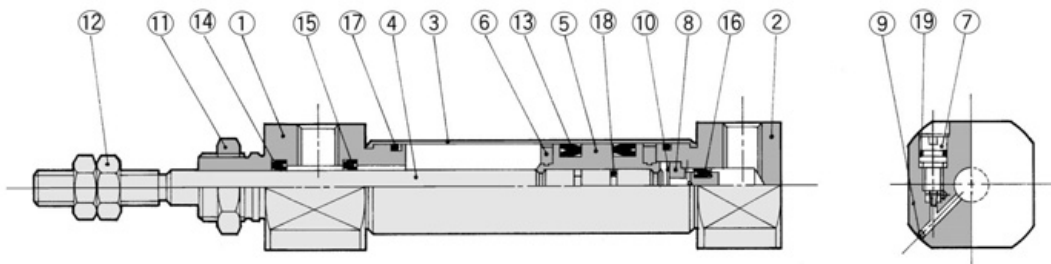
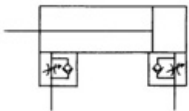

## Component Parts

No.	Description	Material	Note
①	Rod cover	Aluminum alloy	White anodized
②	Head cover	Aluminum alloy	White anodized
③	Cylinder tube	Stainless steel	
④	Piston rod	Stainless steel	
⑤	Piston	Brass	
⑥	Bumper	Urethane	
⑦	Speed controller needle	Stainless steel	
⑧	Check packing sleeve	Brass	
⑨	Steel ball	Bearing steel	
⑩	Retaining ring	Carbon tool steel	Black zinc chromated

No.	Description	Material	Note
⑪	Mounting nut	Brass	Nickel plated
⑫	Rod end nut	Rolled steel	Nickel plated
⑬	Piston seal	NBR	
⑭	Rod seal	NBR	
⑮	Check seal A	NBR	
⑯	Check seal B	NBR	
⑰	Tube gasket	NBR	
⑱	Piston gasket	NBR	
⑲	Needle seal	NBR	

# Built-in Speed Controller: Double Acting Single Rod *Series CJ2Z*

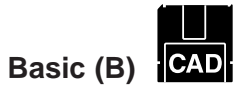

CJ2ZB

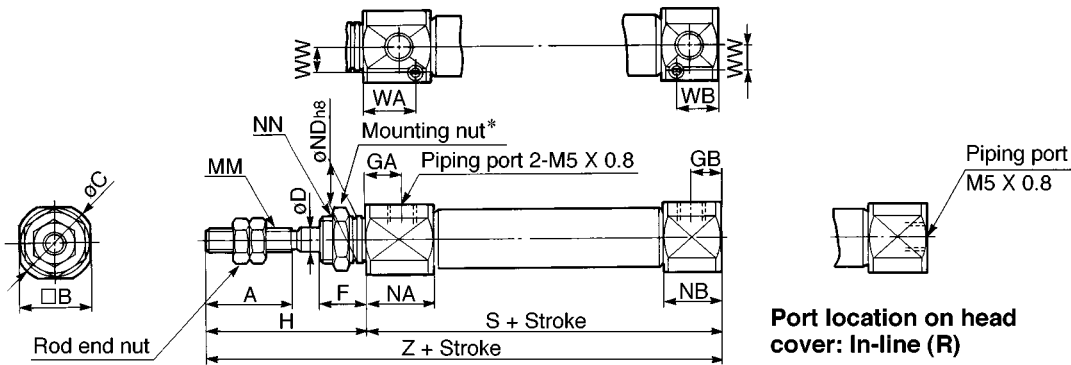

\* Refer to p.1.3-12 for details of the mounting nut.

Bore	A	B	C	D	F	GA	GB	H	MM	NA	NB	NDh8	NN	WA	WB	WW	S	Z
10	15	15	17	4	8	7.5	6.5	28	M4 X 0.7	21	18	8 <sup>0</sup> <sub>-0.022</sub>	M8 X 1.0	14.5	13.5	4.5	63	91
16	15	18	20	5	8	7.5	6.5	28	M5 X 0.8	21	18	10 <sup>0</sup> <sub>-0.022</sub>	M10 X 1.0	14.5	13.5	5.5	64	92

## Axial Foot (L)

CJ2ZL

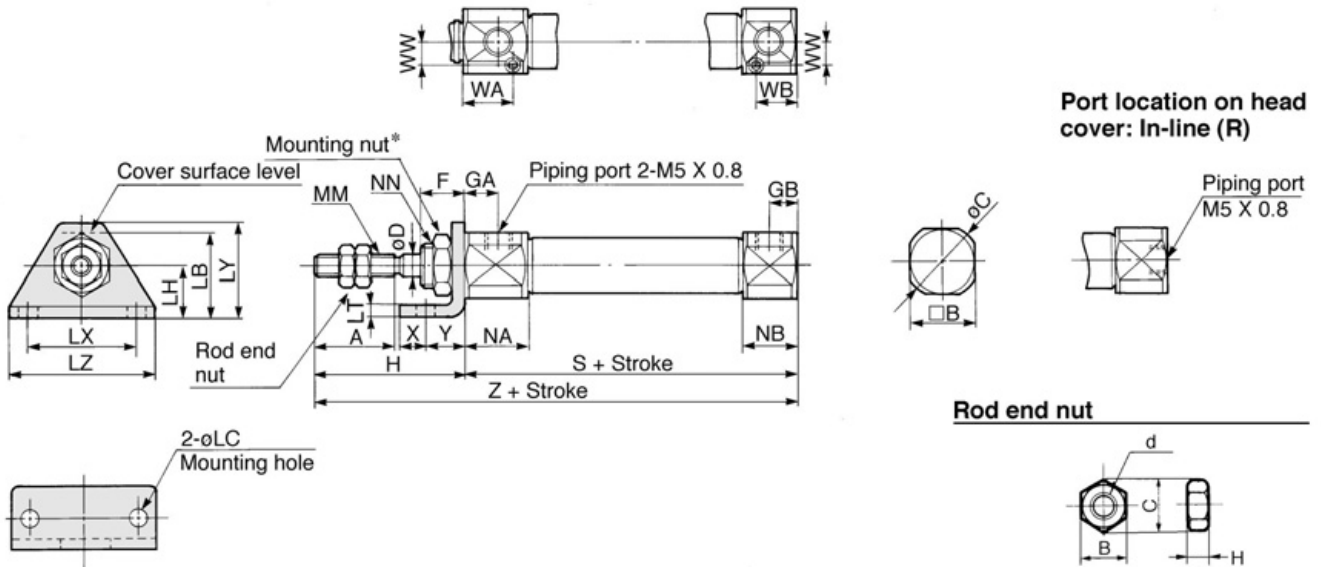

Material: Iron

Part No.	Bore	B	C	d	H
NTJ-010A	10	7	8.1	M4 X 0.7	3.2
NTJ-015A	16	8	9.2	M5 X 0.8	4

\* Refer to p.1.3-12 for details of the mounting nut.

Bore	A	B	C	D	F	GA	GB	H	LB	LC	LH	LT	LX	LY	LZ	MM	NA	NB	NN	S	WA	WB	WW	X	Y	Z
10	15	15	17	4	8	7.5	6.5	28	16.5	4.5	9	1.6	24	16.5	32	M4 X 0.7	21	18	M8 X 1.0	63	14.5	13.5	4.5	5	7	91
16	15	18	20	5	8	7.5	6.5	28	23	5.5	14	2.3	33	25	42	M5 X 0.8	21	18	M10 X 1.0	64	14.5	13.5	5.5	6	9	92



Basic                      Foot  
 CJ2Z□10 ..... SCJ210, #9      SCJ210, #9, #3  
 CJ2Z□16 ..... SCJ216, #9      SCJ216, #9, #3

\* The data shows auto switch styles.  
 Please delete the unnecessary parts.

# Series CJ2Z

## Front Flange (F)



CJ2ZF Bore size Stroke Port location on head cover

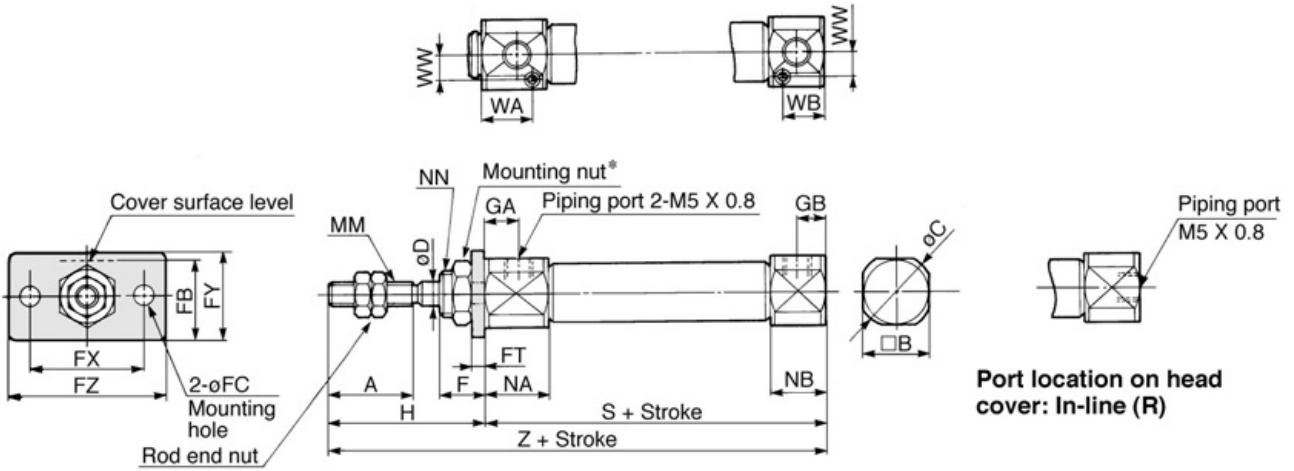

\* Refer to p.1.3-12 for details of the mounting nut.

Bore	A	B	C	D	F	FB	FC	FT	FX	FY	FZ	GA	GB	H	MM	NA	NB	NN	WA	WB	WW	S	Z
10	15	15	17	4	8	14.5	4.5	1.6	24	14	32	7.5	6.5	28	M4 X 0.7	21	18	M8 X 1.0	14.5	13.5	4.5	63	91
16	15	18	20	5	8	19	5.5	2.3	33	20	42	7.5	6.5	28	M5 X 0.8	21	18	M10 X 1.0	14.5	13.5	5.5	64	92

## Double Clevis (D)

CJ2ZD Bore size Stroke

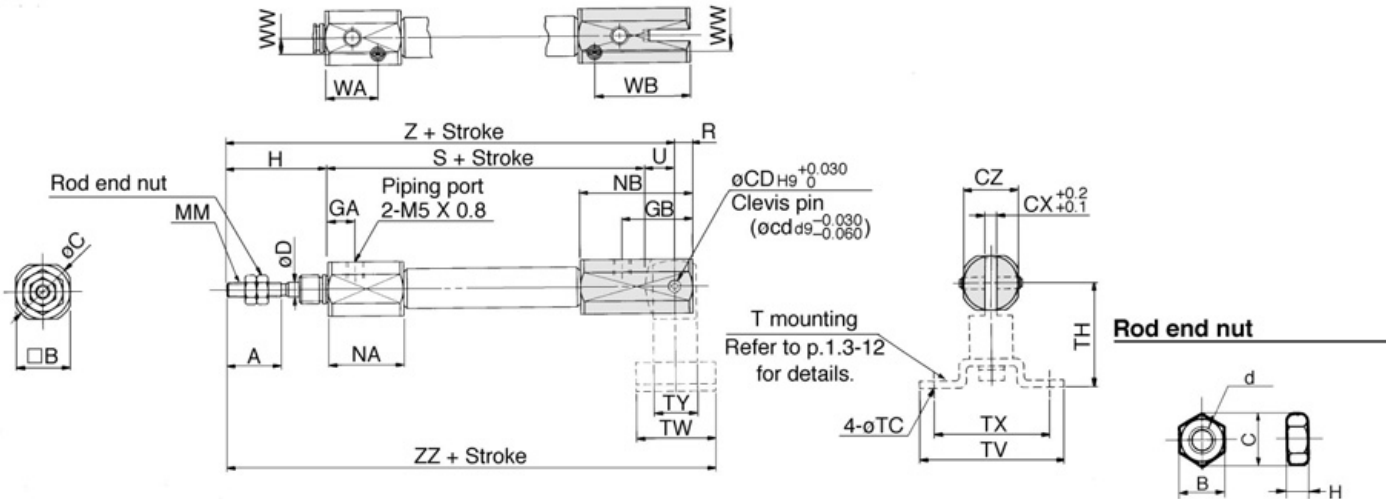

Material: Iron

Part No.	Bore	B	C	d	H
NTJ-010A	10	7	8.1	M4 X 0.7	3.2
NTJ-015A	16	8	9.2	M5 X 0.8	4

\* Clevis pins and set rings are attached.

Bore	A	B	C	CD(ct)	CX	CZ	D	GA	GB	H	MM	NA	NB	R	S	U	WA	WB	WW	Z	ZZ
10	15	15	17	3.3	3.2	15	4	7.5	19.5	28	M4 X 0.7	21	31	5	63	8	14.5	26.5	4.5	99	110
16	15	18	20	5	6.5	18	5	7.5	24.5	28	M5 X 0.8	21	36	8	64	10	14.5	31.5	5.5	102	116

## T mounting dimensions

(mm)

Bore	TC	TH	TV	TW	TX	TY
10	4.5	29	40	22	32	12
16	5.5	35	48	28	38	16



Basic Flange Double clevis  
 CJ2Z□10 ..... SCJ210, #9 SCJ210, #9, #4  
 CJ2Z□16 ..... SCJ216, #9 SCJ216, #9, #4

\* The data shows auto switch equipped styles.  
 Please delete the unnecessary parts.

# Built-in Speed Controller: Double Acting Double Rod

# Series CJ2ZW

ø10, ø16

## How to Order

**Bore size**

10	10mm
16	16mm

**Mounting**

B	Basic
L	Axial foot
F	Front flange

**Standard stroke (mm)**

ø10	15, 30, 45, 60
ø16	15, 30, 45, 60

**Standard**  
CJ2ZW L 16 45

**With auto switch**  
CDJ2ZW L 16 45 C73

**With auto switch (Built-in magnet)**

**Auto switch**

—	2
S	1
n	n

\* Refer to the table below for selecting applicable auto switches.  
\* If requiring a built-in-magnet cylinder without an auto switch, refer to the model number example below.

- CJ1
- CJP
- CJ2**
- CM2
- C85
- CG1
- MB
- C95
- CA1
- CS1

### Applicable Auto Switches/Refer to p.5.3-2 for further information on auto switch.

Style	Special function	Electrical entry	Indicator	Wiring (Output)	Load voltage		Auto switch model**			Lead wire* (m)				Applicable load			
					DC	AC	Band	Rail		0.5 (→)	3 (L)	5 (Z)	None (N)	IC	PLC		
								Perp.	In-line								
Reed switch	—	Grommet	Yes	3 wire (NPN)	5V	—	C76	—	A76H	●	●	—	—	—	—	—	
					—	200V	—	A72	A72H	●	●	—	—	—	—		
					12V	100V	C73	A73	A73H	●	●	●	—	—	—		
		Connector	No	2 wire	24V	5V, 12V	≤100V	C80	A80	A80H	●	●	—	—	—	IC	Relay PLC
						12V	—	C73C	A73C	—	●	●	●	●	—	—	
						5V, 12V	≤24V	C80C	A80C	—	●	●	●	●	—	—	
Diagnostic indication (2 color)	—	Grommet	Yes	—	—	A79W	—	—	●	●	—	—	—	—			
Solid state switch	—	Grommet	No	3 wire (NPN)	5V, 12V	—	H7A1	F7NV	F79	●	●	○	—	—	IC		
							H7A2	F7PV	F7P	●	●	○	—	—	—		
		Connector	No	2 wire	12V	—	H7B	F7BV	J79	●	●	○	—	—	—		
							H7C	J79C	—	●	●	●	●	—	—		
	Diagnostic indication (2 color)	Grommet	Yes	2 wire	24V	5V, 12V	—	H7NW	F7NWV	F79W	●	●	○	—	—	IC	
								H7PW	—	F7PW	●	●	○	—	—	—	
								H7BW	H7BWV	J79W	●	●	○	—	—	—	
								H7BA	—	F7BA	—	●	○	—	—	—	
	Water resistant (2 color)	—	Grommet	No	2 wire	12V	—	—	—	F7NT	—	●	○	—	—		
	With timer	—						—	F7NT	—	●	○	—	—			
	With diagnostic output (2 color)	—	Grommet	Yes	3 wire (NPN)	5V, 12V	—	H7NF	—	F79F	●	●	○	—	—	IC	
	Latch with diagnostic output (2 color)	—						—	F79F	●	●	○	—	—			
—	—	Grommet	No	4 wire (NPN)	—	—	H7LF	—	F7LF	●	●	○	—	—			
—	—						—	F7LF	●	●	○	—	—				

### Part No. of Cylinder with Built-in Magnet

Symbol "-A" (rail mounting) or "-B" (band mounting) should be suffixed to the part No. of the cylinder with auto switch.

Ex.	Rail mounting	CDJ2ZWB16-60-A
	Band mounting	CDJ2ZWB10-45-B

\* Lead wire length 0.5m..... e.g.) C73C 5m.....Z e.g.) C73CZ  
3m.....L C73CL None.....N C73CN

\* Solid state switches marked with "○" are manufactured upon receipt of order.

\*\* "D-A79W" cannot be mounted on bore size ø10 cylinder with air cushion.

# Series CJ2ZW

## Space saving air cylinder with built-in speed controller



### Specifications

Action	Double acting/Double rod	
Fluid	Air	
Proof pressure	1.05MPa	
Max. operating pressure	0.7MPa	
Min. operating pressure	0.1MPa	
Ambient and fluid temperature	Without auto switch: -10°C to 70°C, With auto switch: -10°C to 60°C*	
Cushion	Rubber bumper	
Lubrication	Non-lube	
Thread tolerance	JIS class 2	
Stroke tolerance	+1.0 0	
Speed controller	Built-in	
Mounting	Basic, Axial foot, Front flange	
Piston speed	50 to 750mm/s	
Allowable kinetic energy	ø10	0.035J
	ø16	0.090J

\* No freezing

### Minimum Strokes for Auto Switch Mounting

• Refer to p.1.3-3.

### Standard Stroke (mm)

Bore size	Standard stroke
10	15, 30, 45, 60
16	15, 30, 45, 60

### JIS symbol

Double acting/Double rod

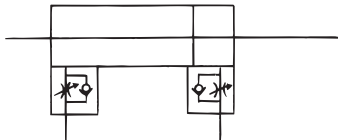

### Mounting Accessories/Refer to p.1.3-12 for details.

Mounting		Basic	Axial foot	Front flange
Standard	Mounting nut	●	●	●
	Rod end nut	●	●	●
Option	Single knuckle joint	●	●	●
	Double knuckle joint*	●	●	●

\* Double clevis or double knuckle joint are packaged with pins and rings.

## ⚠ Precautions

Refer to p.1.3-14 before  
handling.

### Mounting Bracket Part No.

Bracket	Bore size (mm)	
	10	16
Foot	CJ-L010B	CJ-L016B
Flange	CJ-F010B	CJ-F016B

### Auto Switch Mounting Bracket Part No. (Band mounting)

Bore size (mm)	Bracket part No.	Note
10	BJ2-010	Common use to all of D-C7, C8 and D-H7
16	BJ2-016	



# Built-in Speed Controller: Double Acting Double Rod *Series CJ2ZW*

## Weight

(g)

Bore size (mm)	<b>10</b>	<b>16</b>
Basic weight*	50	85
Additional weight for each 15 of stroke	6	9
Mounting bracket weight	Axial foot	16
	Front flange	5
		15

\* This basic weight includes weight of rod end nut.

Calculation example:

CJ2ZWL10-45

- Basic weight ..... 50 (ø10)
- Additional weight ..... 6/15 stroke
- Cylinder stroke ..... 45 stroke
- Mounting bracket weight ..... 16 (Axial foot)  
50+6/15 X 45+16=84g

## Copper Free

20-CJ2WZ **Mounting** **Bore size** **Stroke** **Port location on head cover**

•Copper free

To eliminate influences of copper ions or halogen ions during CRT manufacturing processes, copper and fluorine materials are not used as component parts.



## Specifications

Action	Double acting/Double rod
Bore size (mm)	ø10, ø16
Max. operating pressure	0.7MPa
Min. operating pressure	0.1MPa
Cushion	Rubber bumper
Standard stroke (mm)	15, 30, 45, 60
Auto switch	Possible to be mounted
Mounting	Basic, Axial foot, Front flange

CJ1

CJP

**CJ2**

CM2

C85

CG1

MB

C95

CA1

CS1

## Construction (The cylinder cannot be disassembled.)

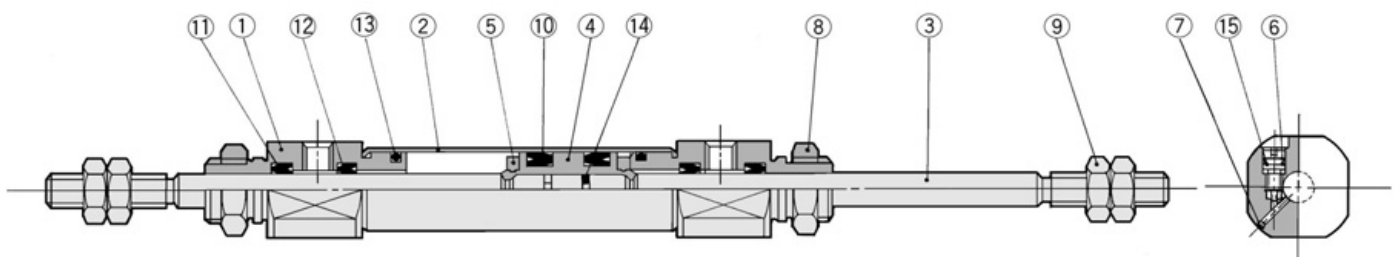
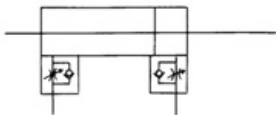

## Component Parts

No.	Description	Material	Note
①	Rod cover	Aluminum alloy	White anodized
②	Cylinder tube	Stainless steel	
③	Piston rod	Stainless steel	
④	Piston	Brass	
⑤	Bumper	Urethane	
⑥	Speed controller needle	Stainless steel	
⑦	Steel ball	Bearing steel	
⑧	Mounting nut	Brass	Nickel plated

No.	Description	Material	Note
⑨	Rod end nut	Rolled steel	Nickel plated
⑩	Piston seal	NBR	
⑪	Rod seal	NBR	
⑫	Check seal	NBR	
⑬	Tube gasket	NBR	
⑭	Piston gasket	NBR	
⑮	Needle seal	NBR	

# Series CJ2ZW

## Basic (B)

CJ2ZWB Bore size Stroke

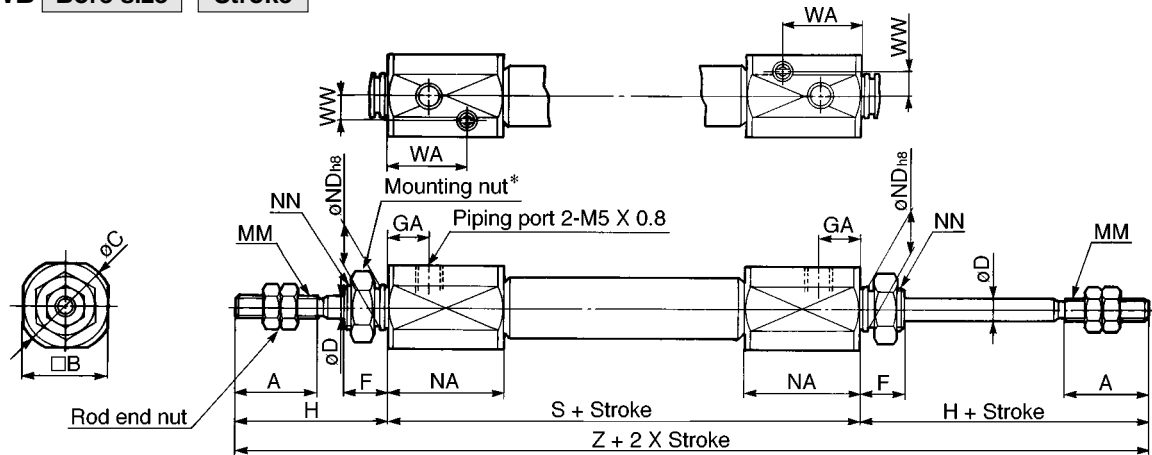

\* Refer to p.1.3-12 for details of the mounting nut.

Bore	A	B	C	D	F	GA	H	MM	NA	NDh8	NN	S	WA	WW	Z
10	15	15	17	4	8	7.5	28	M4 X 0.7	21	8 <sub>-0.022</sub>	M8 X 1.0	66	14.5	4.5	122
16	15	18	20	5	8	7.5	28	M5 X 0.8	21	10 <sub>-0.022</sub>	M10 X 1.0	67	14.5	5.5	123

## Axial Foot (L)

CJ2ZWL Bore size Stroke

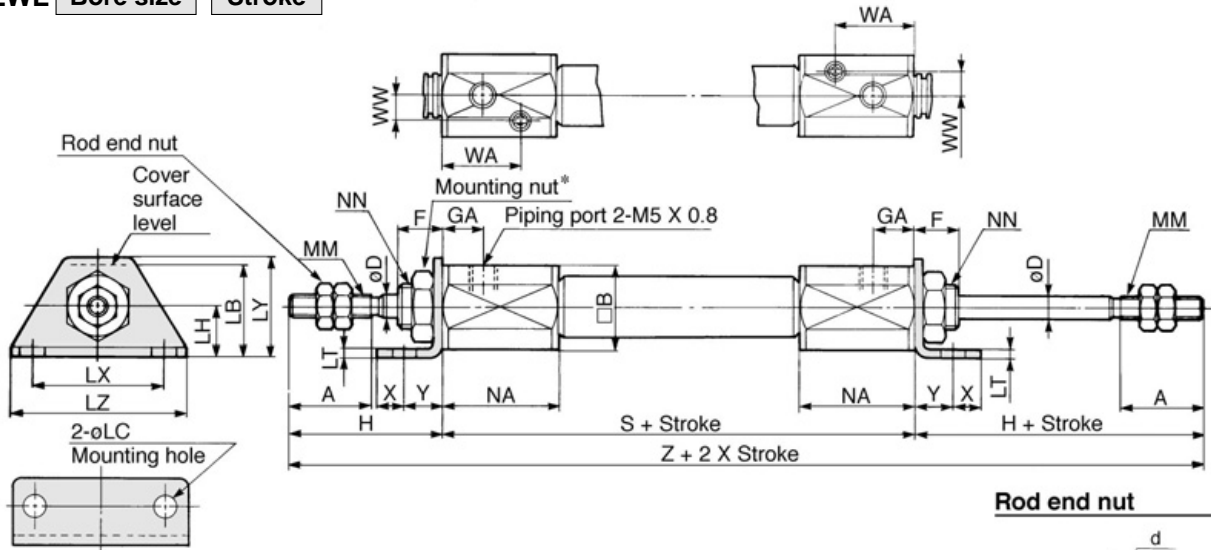

Rod end nut

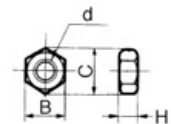

Material: Iron

Part No.	Bore	B	C	d	H
NTJ-010A	10	7	8.1	M4 X 0.7	3.2
NTJ-015A	16	8	9.2	M5 X 0.8	4

\* Refer to p.1.3-12 for details of the mounting nut.

Bore	A	B	D	F	LB	LC	LH	LT	LX	LY	LZ	GA	H	MM	NA	NN	S	WA	WW	X	Y	Z
10	15	15	4	8	16.5	4.5	9	1.6	24	16.5	32	7.5	28	M4 X 0.7	21	M8 X 1.0	66	14.5	4.5	5	7	122
16	15	18	5	8	23	5.5	14	2.3	33	25	42	7.5	28	M5 X 0.8	21	M10 X 1.0	67	14.5	5.5	6	9	123

# Built-in Speed Controller: Double Acting Double Rod *Series CJ2ZW*

## Front Flange (F)

CJ2ZWF Bore size Stroke

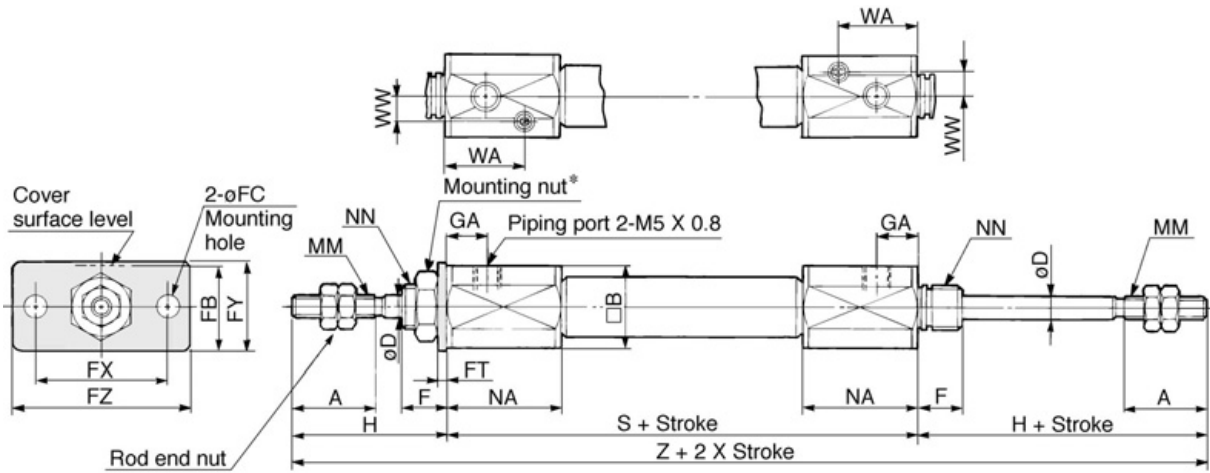

### Rod end nut

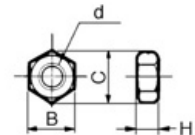

Material: Iron

Part No.	Bore	B	C	d	H
NTJ-010A	10	7	8.1	M4 X 0.7	3.2
NTJ-015A	16	8	9.2	M5 X 0.8	4

\* Refer to p.1.3-12 for details of the mounting nut.

Bore	A	B	D	F	FB	FC	FT	FX	FY	FZ	GA	H	MM	NA	NN	S	WA	WW	Z
10	15	15	4	8	14.5	4.5	1.6	24	14	32	7.5	28	M4 X 0.7	21	M8 X 1.0	66	14.5	4.5	122
16	15	18	5	8	19	5.5	2.3	33	20	42	7.5	28	M5 X 0.8	21	M10 X 1.0	67	14.5	5.5	123

(mm)

- CJ1
- CJP
- CJ2**
- CM2
- C85
- CG1
- MB
- C95
- CA1
- CS1

# Low Friction: Double Acting Single Rod

## Series CJ2Q



ø10, ø16

### How to Order

**Bore size**

10	10mm
16	16mm

**Mounting**

B	Basic
L	Axial foot
F	Front flange
D	Double clevis

**Standard stroke (mm)**

ø10	15, 30, 45, 60, 75, 100, 125, 150
ø16	15, 30, 45, 60, 75, 100, 125, 150, 175, 200

**Standard**  
CJ2Q L 16 — 60

**With auto switch**  
CDJ2Q L 16 — 60 — C73

**With auto switch (Built-in magnet)**

**Port location on head cover**

Symbol	Port location
—	Perpendicular
R	In-line

\* Refer to p.1.3-54 for the configuration.

**Auto switch**

- \* Refer to the table below for selecting applicable auto switches.
- \* If requiring a built-in magnet cylinder without an auto switch, refer to the model number example below.

**Number of switches**

—	2
S	1
n	n

**Band mounting**

**Rail mounting**

### Applicable Auto Switches/Refer to p.5.3-2 for further information on auto switch.

Style	Special function	Electrical entry	Indicator	Wiring (Output)	Load voltage		Auto switch model			Lead wire* (m)				Applicable load	
					DC	AC	Band	Rail		0.5 (-)	3 (L)	5 (Z)	None (N)		
Reed switch	—	Grommet	Yes	3 wire (NPN)	—	5V	—	C76	—	A76H	●	●	—	—	IC
				2 wire		12V	100V	C73	A73	A73H	●	●	●	—	—
						5V, 12V	≤100V	C80	A80	A80H	●	●	—	—	IC
						12V	—	C73C	A73C	—	●	●	●	●	—
						5V, 12V	≤24V	C80C	A80C	—	●	●	●	●	IC
Diagnostic indication (2 color)	Grommet	Yes	—	—	—	—	A79W	—	—	●	●	—	—	—	
Solid state switch	—	Grommet	Yes	3 wire (NPN)	5V, 12V	—	—	H7A1	F7NV	F79	●	●	○	—	IC
				3 wire (PNP)				H7A2	F7PV	F7P	●	●	○	—	—
				2 wire				12V	—	H7B	F7BV	J79	●	●	○
	—	—	H7C		J79C	—	●	●	●	●	—				
	Diagnostic indication (2 color)	Grommet	Yes	3 wire (NPN)	5V, 12V	—	24V	H7NW	F7NWV	F79W	●	●	○	—	IC
				3 wire (PNP)				H7PW	—	F7PW	●	●	○	—	—
				2 wire				H7BW	H7BWV	J79W	●	●	○	—	—
								—	—	F7BA	—	●	○	—	—
	Water resistant (2 color)	Grommet	Yes	2 wire	12V	—	—	—	—	F7NT	—	●	○	—	IC
	With timer			3 wire (NPN)				5V, 12V	—	—	F7NT	—	●	○	—
	With diagnostic output (2 color)			4 wire (NPN)					H7NF	—	F79F	●	●	○	—
Latch with diagnostic output (2 color)	—	—	—	—	—	—	H7LF	—	F7LF	●	●	○	—	—	

### Part No. of Cylinder with Built-in Magnet

Symbol “-A” (rail mounting) or “-B” (band mounting) should be suffixed to the part No. of the cylinder with auto switch.

Ex.	Rail mounting	CDJ2QB16-60-A
	Band mounting	CDJ2QB10-45-B

\* Lead wire length 0.5m..... e.g.) C73C 5m.....Z e.g.) C73CZ  
3m.....L C73CL None.....N C73CN

\* Solid state switches marked with “○” are manufactured upon receipt of order.

# Low Friction Style: Double Acting Single Rod *Series CJ2Q*

**Specially designed to keep friction of the piston to a minimum. Suitable for contact-pressure control requiring smooth operation at low pressures.**

## Low Friction

Min. operating pressure: 0.03MPa



## Application Example

The low friction cylinder should be used with precision regulator (e.g. Series IR).

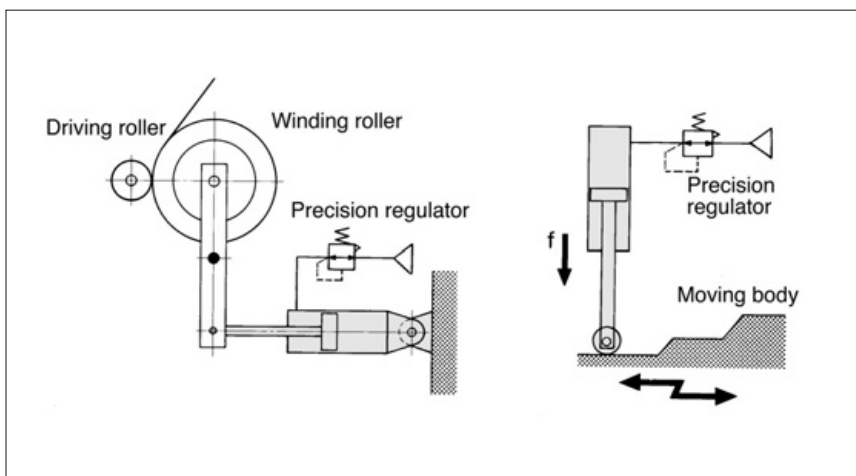

## Specifications

Action	Double acting/Single rod	
Fluid	Air	
Proof pressure	1.05MPa	
Max. operating pressure	0.7MPa	
Min. operating pressure	0.03MPa	
Ambient and fluid temperature	Without auto switch: -10°C to 70°C, With auto switch: -10°C to 60°C*	
Cushion	Rubber bumper	
Lubrication	Non-lube	
Thread tolerance	JIS class 2	
Stroke tolerance	+1.0 0	
Bore size (mm)	ø10, ø16	
Mounting	Basic, Axial foot, Front flange, Double clevis	
Piston speed	50 to 750mm/s	
Allowable kinetic energy	ø10	0.035J
	ø16	0.090J

\* No freezing

## JIS symbol

Double acting/Single rod

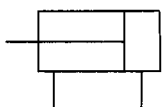

## ⚠ Precautions

**Refer to p.0-39 to 0-46 before handling.**

## Minimum Stroke for Auto Switch Mounting

•Refer to p.1.3-3.

## Standard Stroke (mm)

Bore size	Standard stroke
10	15, 30, 45, 60, 75, 100, 125, 150
16	15, 30, 45, 60, 75, 100, 125, 150, 175, 200

CJ1

CJP

**CJ2**

CM2

C85

CG1

MB

C95

CA1

CS1

# Series CJ2Q

## Mounting Accessories/Refer to p.1.3-12 for details.

Mounting		Basic	Axial foot	Front flange	Double clevis*
Standard	Mounting nut	●	●	●	—
	Rod end nut	●	●	●	●
	Clevis pin	—	—	—	●
Option	Single knuckle joint	●	●	●	●
	Double knuckle joint*	●	●	●	●
	T bracket	—	—	—	●

\* Double clevis or double knuckle joint are packaged with pins and rings.

## Mounting Bracket Part No.

Mounting bracket	Bore size (mm)	
	10	16
Foot	CJ-L010B	CJ-L016B
Flange	CJ-F010B	CJ-F016B
T bracket*	CJ-T010B	CJ-T016B

\* T bracket is used with double clevis (D).

## Auto Switch Mounting Bracket Part No. (Band mounting)

Bore size (mm)	Bracket part No.	Note
10	BJ2-010	Common use to all of D-C7, C8 and D-H7
16	BJ2-016	



Note) A set of stainless steel mounting screws "BBA4" is attached. (A switch mounting band is not attached. Please order the band separately.) "BBA4" screws are used for D-C7/C8/H7. "D-H7BAL" switch is set on the cylinder with the screws above when shipped. Also, when a switch only is shipped, "BBA4" screws are attached.

## Port Location on Head Cover

Either perpendicular to the cylinder axis or in-line with the cylinder axis is available for basic style.



In-line



Perpendicular

## Sliding Resistance at the Low Friction Side

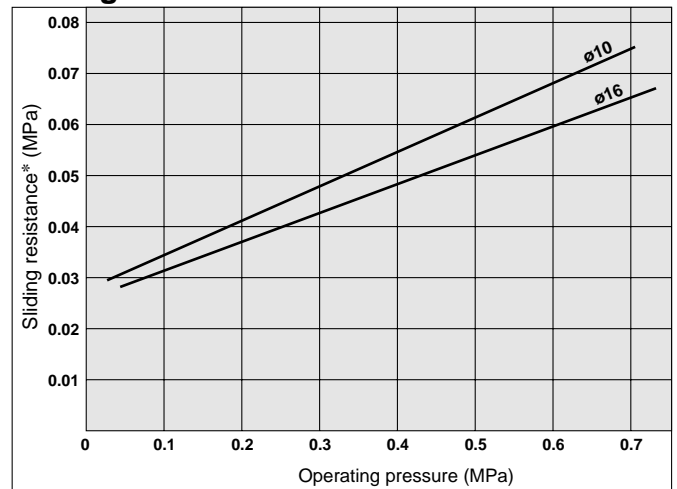

\* Converted to cylinder operating pressure.

## Weight

(g)

Bore size (mm)		10	16
Basic weight*		24	55
Additional weight for each 15 of stroke		4	6.5
Mounting bracket weight	Axial foot	8	20
	Front flange	5	15
	Double clevis** (with pins)	4	10

\* This basic weight includes weights of mounting nut and rod end nut.

\*\* The mounting nut is not attached to the double clevis style, so the mounting nut weight is already reduced.

Calculation example) CJ2QL10-45

- Basic weight ..... 24 (ø10)
  - Additional weight ..... 4/15 stroke
  - Cylinder stroke ..... 45 stroke
  - Mounting bracket weight ..... 8 (Axial foot)
- 24+4/15 X 45+8=44g

# Low Friction Style: Double Acting Single Rod *Series CJ2Q*

Construction (The cylinder cannot be disassembled.)

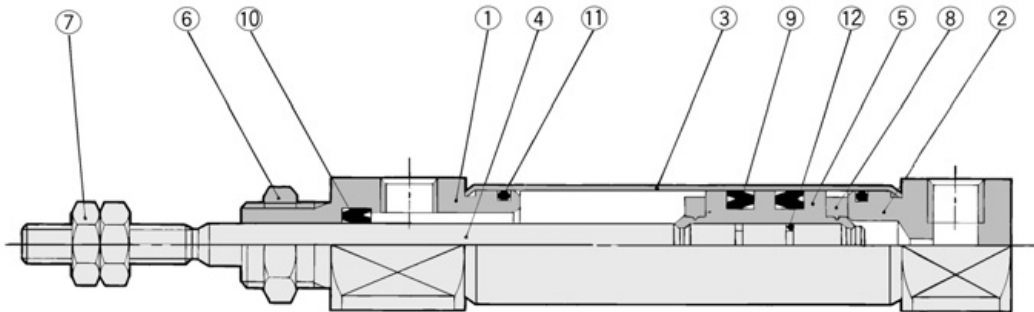
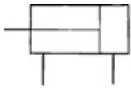

## Component Parts

No.	Description	Material	Note
①	Rod cover	Aluminum alloy	White anodized
②	Head cover	Aluminum alloy	White anodized
③	Cylinder tube	Stainless steel	
④	Piston rod	Stainless steel	
⑤	Piston	Brass	
⑥	Mounting nut	Brass	Nickel plated

No.	Description	Material	Note
⑦	Rod end nut	Rolled steel	Nickel plated
⑧	Bumper	Urethane	
⑨	Piston seal	NBR	
⑩	Rod seal	NBR	
⑪	Tube gasket	NBR	
⑫	Piston gasket	NBR	

CJ1

CJP

**CJ2**

CM2

C85

CG1

MB

C95

CA1

CS1

## Basic Style (B)

**CJ2QB** **Bore size** **Stroke** **Port location on head cover**

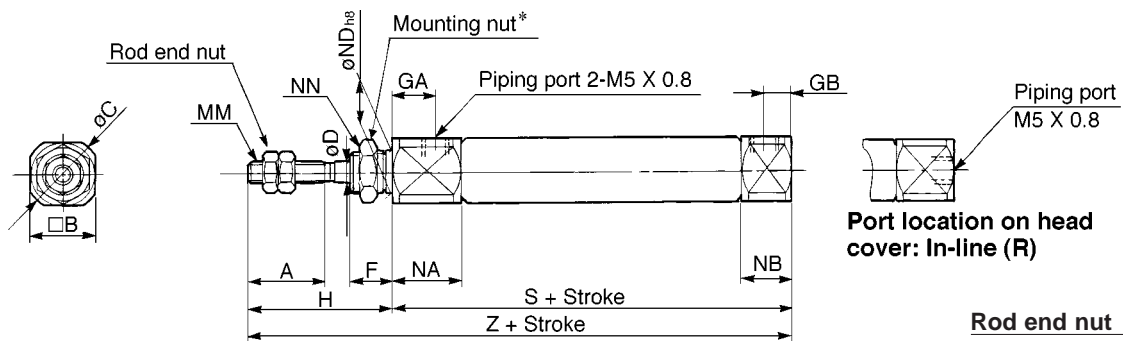

Rod end nut

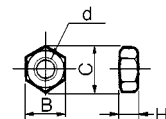

Material: Iron

Part No.	Bore	B	C	d	H
NTJ-010A	10	7	8.1	M4 X 0.7	3.2
NTJ-015A	16	8	9.2	M5 X 0.8	4

\* Refer to p.1.3-12 for details of the mounting nut.

(mm)

Bore	A	B	C	D	F	GA	GB	H	MM	NA	NB	ND	NN	S	Z
10	15	12	14	4	8	8	5	28	M4 X 0.7	12.5	9.5	8 <sup>0</sup> <sub>-0.022</sub>	M8 X 1.0	46	74
16	15	18	20	5	8	8	5	28	M5 X 0.8	12.5	9.5	10 <sup>0</sup> <sub>-0.022</sub>	M10 X 1.0	47	75

Refer to p.1.3-8 to 1.3-10 for dimensions of each mounting bracket.

	Basic	Foot	Front flange	Double clevis
JT2Q□10	SCJ210, #1	SCJ210, #1, #3	SCJ210, #1, #9	SCJ210, #5
JT2Q□16	SCJ216, #1	SCJ216, #1, #3	SCJ216, #1, #9	SCJ216, #5

\* The data shows auto switch equipped styles.

Please delete the unnecessary parts.

# Direct Mount: Double Acting Single Rod

## Series CJ2R



ø10, ø16

### How to Order

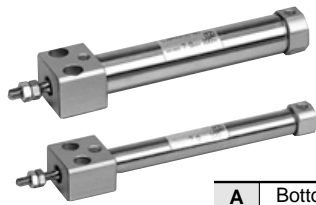

Bore size	
10	10mm
16	16mm

Mounting	
A	Bottom mounting

Standard stroke (mm)	
ø10	15, 30, 45, 60, 75, 100, 125, 150
ø16	15, 30, 45, 60, 75, 100, 125, 150, 175, 200

**Standard**  
**With auto switch**

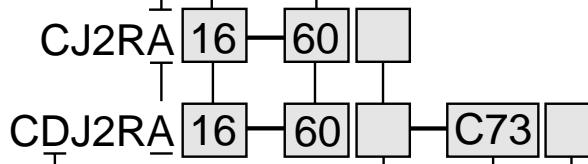

With auto switch  
(Built-in magnet)

Port location on head cover	
Symbol	Port location
—	Perpendicular
R	In-line

\* Refer to p.1.3-58 for the configuration.

Auto switch

\* Refer to the table below for selecting applicable auto switches.

\* If requiring a built-in magnet cylinder without an auto switch, refer to the model number example below.

Number of switches

—	2
S	1
n	n

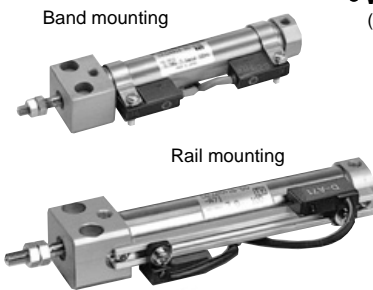

### Applicable Auto Switches/ Refer to p.5.3-2 for further information on auto switch.

Style	Special function	Electrical entry	Indicator	Wiring (Output)	Load voltage		Auto switch model		Lead wire* (m)				Applicable load																
					DC	AC	Band	Rail		0.5 (-)	3 (L)	5 (Z)		None (N)															
Reed switch	—	Grommet	Yes	3 wire (NPN)	—	5V	—	C76	—	A76H	●	●	—	—	IC														
											24V	—	A72	A72H		●	●	—	—										
																12V	100V	C73	A73	A73H	●	●	●	—					
																					5V, 12V	≤100V	C80	A80	A80H	●	●	—	—
																12V	—	C73C	A73C	—						●	●	●	●
																					5V, 12V	≤24V	C80C	A80C	—	●	●	●	●
Grommet	Yes	—	A79W	—	●	●	—	—																					
					Solid state switch	—	Grommet	Yes	3 wire (NPN)	5V, 12V	—	H7A1	F7NV	F79	●	●	○	—	IC										
3 wire (PNP)	—	H7A2	F7PV	F7P											●	●	○	—											
															2 wire	12V	—	H7B		F7BV	J79	●	●	○	—				
																						H7C	J79C	—	●	●	●	●	
															Connector	Yes	24V	5V, 12V		—	—			H7NW	F7NWV	F79W	●	●	○
																						3 wire (PNP)	—				H7PW	—	F7PW
							H7BW	H7BWV	J79W	●	●	○	—																
2 wire	12V	—	H7BA	—						F7BA	—	●	○	—															
							—	—	F7NT		—	●	○	—															
3 wire (NPN)	5V, 12V	—	H7NF	—						F79F	●	●	○	—															
							4 wire (NPN)	—	H7LF		—	F7LF	●	●	○	—													

### Part No. of Cylinder with Built-in Magnet

Symbol "A" (rail mounting) or "B" (band mounting) should be suffixed to the part No. of the cylinder with auto switch.

Ex.	Mounting	Part No.
	Rail mounting	CDJ2RA16-60-A
	Band mounting	CDJ2RA10-45-B

\* Lead wire length 0.5m.....— e.g.) C73C 5m.....Z e.g.) C73CZ  
3m.....L C73CL None.....N C73CN

\* Solid state switches marked with "○" are manufactured upon receipt of order.



# Direct Mount: Double Acting Single Rod *Series CJ2R*

**Square rod cover makes direct contact mounting possible.**

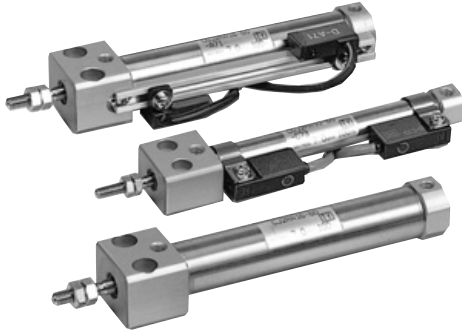

## Specifications

Action	Double acting/Single rod	
Fluid	Air	
Proof pressure	1.05MPa	
Max. operating pressure	0.7MPa	
Min. operating pressure	0.06MPa	
Ambient and fluid temperature	Without auto switch: -10°C to 70°C, With auto switch: -10°C to 60°C*	
Cushion	Rubber bumper	
Lubrication	Non-lube	
Thread tolerance	JIS class 2	
Stroke tolerance	+1.0 0	
Bore size (mm)	ø10, ø16	
Mounting	Bottom mounting	
Piston speed	50 to 750mm/s	
Allowable kinetic energy	ø10	0.035J
	ø16	0.090J

\* No freezing

## Standard Stroke

Bore size	Standard stroke (mm)
10	15, 30, 45, 60, 75, 100, 125, 150
16	15, 30, 45, 60, 75, 100, 125, 150, 175, 200

## JIS symbol

Double acting/Single rod

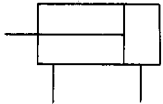

## ⚠ Precautions

Refer to p.1.3-3 before handling.

## Minimum Strokes for Auto Switches Mounting

Mounting	Auto switch model	Number of switches	Min. stroke (mm)
Band mounting	D-C7 D-C8	2 (same surface)	50
		2 (different surfaces)	15
		1	15
	D-H7□ D-H7□W D-H7BAL D-H7NF	2 (same surface)	60
		2 (different surfaces)	20
		1	20
		D-C73C D-C80C D-H7C	2 (same surface)
	2 (different surfaces)		15
	1		15
	D-H7LF	2 (same surface)	65
		2 (different surfaces)	25
		1	25
Rail mounting	D-A7/A8 D-A73C/A80C	2	10
		1	5
	D-F7□V D-J79C	2	5
		1	5
	D-A79W D-F7□WV	2	15
		1	10
	D-F7□, J79, D-F79F, D-A7□H, A80H D-F7□W, J79W D-F7BAL	2	15
		1	15
	D-F7LF	2	25
1		25	

## Accessory/Refer to p.1.3-12 for details.

Standard	Rod end nut
Option	Single knuckle joint, Double knuckle joint*

\* Double knuckle joint is packaged with pins and rings.

CJ1

CJP

**CJ2**

CM2

C85

CG1

MB

C95

CA1

CS1

# Series CJ2R

## Weight

Bore size (mm)	10	16
Basic weight*	36	71.5
Additional weight for each 15 of stroke	4	6.5

\* This basic weight includes weights of rod end nut.

Calculation example) CJ2RA10-45

- Basic weight: ..... 36 (ø10)
- Additional weight: .... 4/15 stroke
- Cylinder stroke: ..... 45 stroke  
36+4/15 X 45=48g

## Port Location on the Head Cover

Either perpendicular to the cylinder axis or in-line with the cylinder axis is available for basic style. (ø6 is available only as in-line style.)



In-line



Perpendicular

## Auto Switch Mounting Bracket Part No.(Band mounting)

Bore size (mm)	Bracket part No.	Note
10	BJ2-010	Common use to all of D-C7, C8 and D-H7
16	BJ2-016	



Note) A set of stainless steel mounting screws "BBA4" is attached. (A switch mounting band is not attached. Please order the band separately.) "BBA4" screws are used for D-C7/C8/H7. "D-H7BAL" switch is set on the cylinder with the screws above when shipped. Also, when a switch only is shipped, "BBA4" screws are attached.

## Clean Series

10-CJ2RA **Mounting** **Bore size** **Stroke** **Port location on head cover**

### Clean series

The rod section of actuator is reinforced with the double-seal structure. The air cylinder can be incorporated in the system which directly discharges the external leak from the clean room through the relief port.

## Specifications

Action	Double acting/Single rod
Bore size (mm)	ø10, ø16
Max. operating pressure	0.7MPa
Min. operating pressure	0.08MPa
Cushion	Rubber bumper
Standard stroke (mm)	Same as the standard (Refer to p.1.3-57.)
Auto switch	Possible to be mounted
Mounting	Rear pivot mounting

## Construction

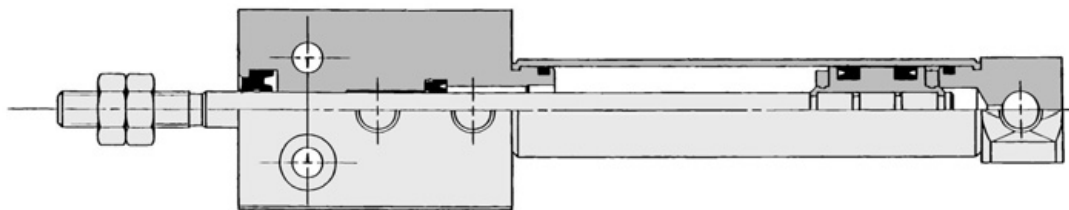

# Direct Mount: Double Acting Single Rod *Series CJ2R*

Construction (The cylinder cannot be disassembled.)

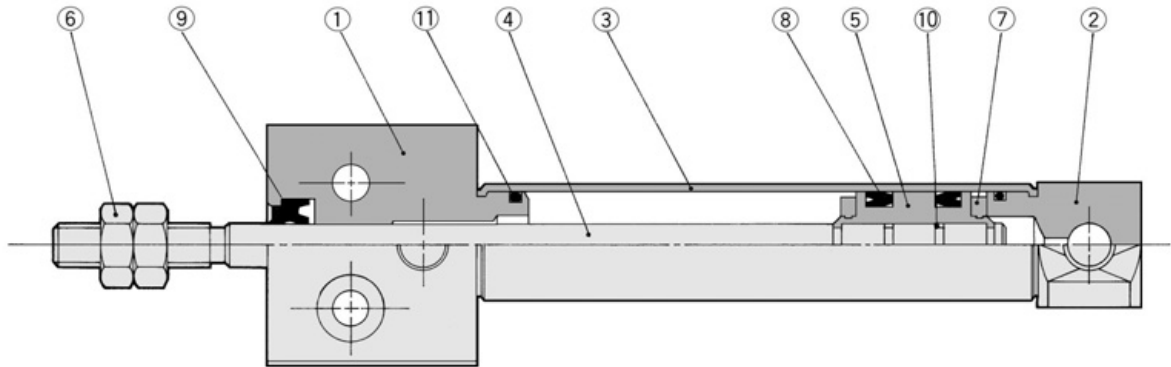
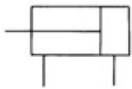

- CJ1
- CJP
- CJ2**
- CM2
- C85
- CG1
- MB
- C95
- CA1
- CS1

## Component Parts

No.	Description	Material	Note
①	Rod cover	Aluminum alloy	White anodized
②	Head cover	Aluminum alloy	White anodized
③	Cylinder tube	Stainless steel	
④	Piston rod	Stainless steel	
⑤	Piston	Brass	
⑥	Rod end nut	Rolled steel	Nickel plated

No.	Description	Material	Note
⑦	Bumper	Urethane	
⑧	Piston seal	NBR	
⑨	Rod seal	NBR	
⑩	Piston gasket	NBR	
⑪	Tube gasket	NBR	

## Bottom Mounting

CJ2RA **Bore size** **Stroke** **Port location on head cover**

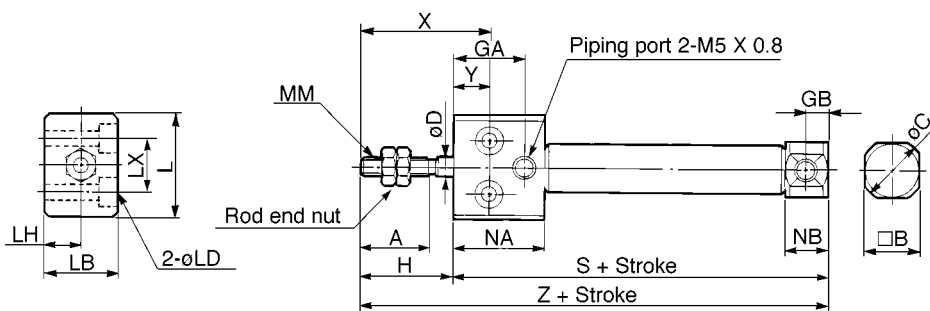

### Port location on head cover: In-line (R)

Piping port M5 X 0.8

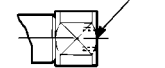

### Rod end nut

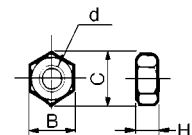

Material: Iron

Part No.	Bore	B	C	d	H
NTJ-010A	10	7	8.1	M4 X 0.7	3.2
NTJ-015A	16	8	9.2	M5 X 0.8	4

Bore	A	B	C	D	GA	GB	H	L	LB	LD	LH	LX	MM	NA	NB	X	Y	S	Z
<b>10</b>	15	12	14	4	16	5	20	23	16	ø3.5, ø6.5 Depth of counter bore: 4	8	12	M4 X 0.7	20.5	9.5	28	8	54	74
<b>16</b>	15	18	20	5	16	5	20	26	20	ø4.5, ø8 Depth of counter bore: 5	10	16	M5 X 0.8	20.5	9.5	28	8	55	75

(mm)



Rear pivot  
 CJ2RA10 ..... SCJ210, #10  
 CJ2RA16 ..... SCJ216, #10

\* The data shows auto switch styles.  
 Please delete the unnecessary parts.

# Series CDJ2R

## Auto Switch Mounting Position

### Reed Switch <Band mounting> D-C7/C8

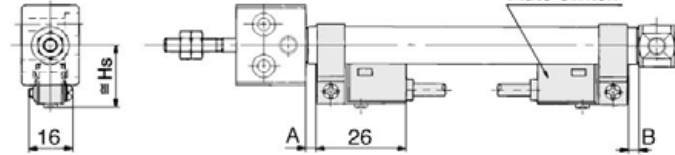

### Solid State Switch <Band mounting> D-H7□/H7□W/H7BAL/H7□F

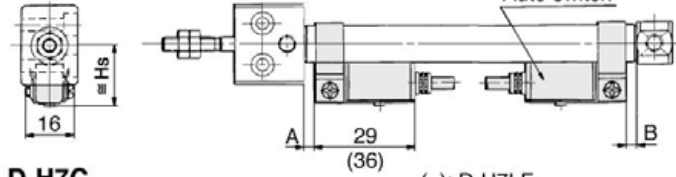

### D-C73C/C80C

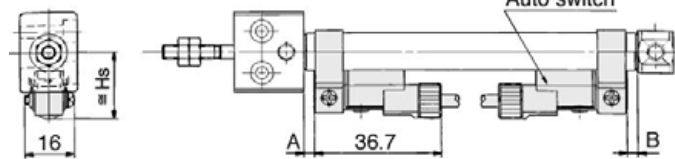

### D-H7C

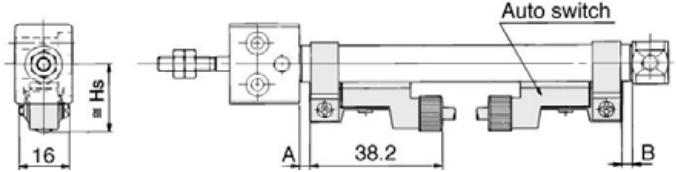

( ): D-H7LF

### <Rail mounting> D-A7/A8

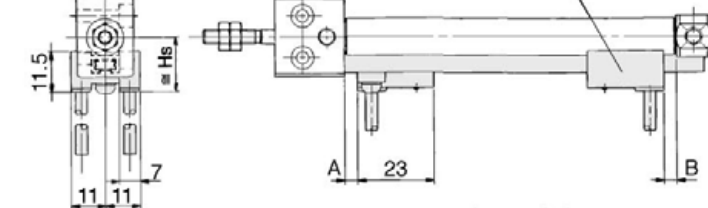

### <Rail mounting> D-F7/J7 D-F7□W/J79W D-F7□F/F7BAL

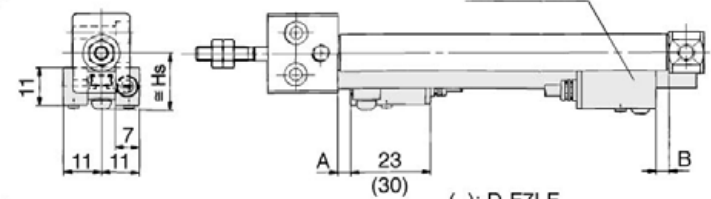

### D-A7□H/A80H

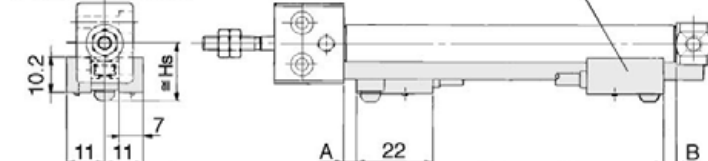

### D-F7□V/F7□VW

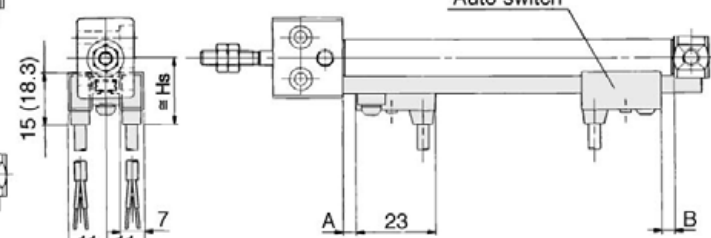

( ): D-F7LF

### D-A73C/A80C

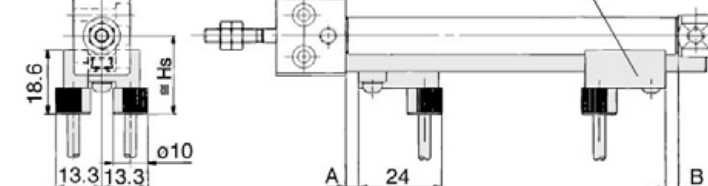

### D-J79C

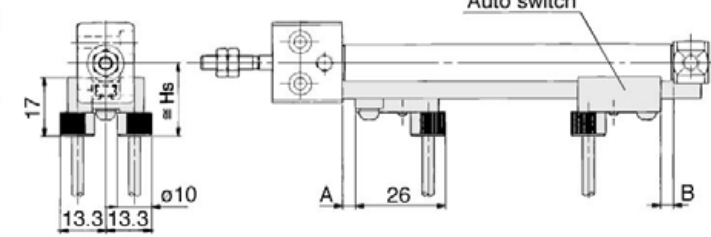

### D-A79W

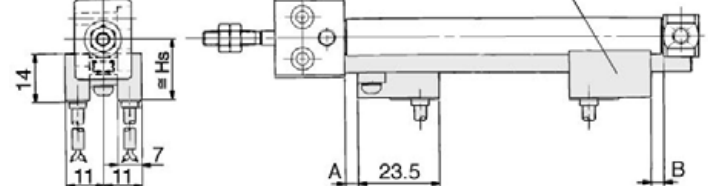

## Auto Switch Mounting Position

Auto switch model	D-C7 D-C8 D-C73C D-C80C		D-H7□ D-H7C		D-H7□W D-H7BAL D-H7□F		D-A7 D-A8		D-A7□H/A80H D-A73C/A80C D-F7/J7 D-J79C D-F7□V		D-F7□W D-F7BAL D-F7□F D-J79W D-F7□VW		D-A79W	
	A	B	A	B	A	B	A	B	A	B	A	B	A	B
Bore size 10	2.5	2.5	1.5	1.5	0	0	3	3	3.5	3.5	7.5	7.5	0.5	0.5
Bore size 16	3	3	2	2	0.5	0.5	3.5	3.5	4	4	8	8	1	1

## Auto Switch Mounting Height

Auto switch model	D-C7/C8 D-H7□/H7□W D-H7□F D-H7BAL	D-C73C D-C80C	D-H7C	D-A7 D-A8	D-A7□H/A80H D-F7/J7 D-F7□W/J79W D-F7BAL/F7□F	D-A73C D-A80C	D-F7□V D-F7□VW	D-J79C	D-A79W
Bore size	Hs	Hs	Hs	Hs	Hs	Hs	Hs	Hs	Hs
10	17	19.5	20	16.5	17.5	23.5	20	23	19
16	20.5	23	23.5	19.5	20.5	26.5	23	26	22

# Direct Mount: Single Acting Spring Return/Extend

# Series CJ2R

ø10, ø16

## How to Order

**Standard**  
CJ2RA 16-45 S

**With auto switch**  
CDJ2RA 16-45 S C73

**Bore size**

10	10mm
16	16mm

**Standard stroke (mm)**

ø10	15, 30, 45, 60
ø16	15, 30, 45, 60, 75, 100, 125, 150

**Mounting**

A	Bottom mounting
---	-----------------

**Action**

S	Single acting/Spring Return
T	Single acting/Spring Extend

**Port location on head cover**

Symbol	Port location
—	Perpendicular
R	In-line

**Number of switches**

—	2
S	1
n	n

**With auto switch (Built-in magnet)**

**Auto switch**

- \* Refer to the table below for selecting applicable auto switches.
- \* If requiring a built-in magnet cylinder without an auto switch, refer to the model number example below.

- CJ1
- CJP
- CJ2**
- CM2
- C85
- CG1
- MB
- C95
- CA1
- CS1

### Applicable Auto Switches/Refer to p.5.3-2 for further information on auto switch.

Style	Special function	Electrical entry	Indicator	Wiring (Output)	Load voltage		Auto switch model		Lead wire* (m)				Applicable load											
					DC	AC	Band	Rail		0.5 (-)	3 (L)	5 (Z)	None (N)	IC	Relay PLC									
								Perp.	In-line															
Reed switch	—	Grommet	Yes	3 wire (NPN)	—	5V	—	C76	—	A76H	●	●	—	—	IC	—								
											2 wire	24V	—	—			200V	—	A72	A72H	●	●	—	—
													12V	100V			C73	A73	A73H	●	●	●	—	
												5V, 12V	≤100V	C80			A80	A80H	●	●	—	—		
													12V	—			C73C	A73C	—	●	●	●	●	
											5V, 12V	≤24V	C80C	A80C			—	●	●	●	●			
—	—	—	A79W	—	●	●	—	—																
Solid state switch	—	Grommet	Yes	3 wire (NPN)	—	5V, 12V	—	H7A1	F7NV	F79	●	●	○	—	IC	—								
											3 wire (PNP)	H7A2	F7PV	F7P			●	●	○	—				
												2 wire	12V	—			H7B	F7BV	J79	●	●	○	—	
		Connector		24V				5V, 12V	≤100V	H7C	J79C		—	●			●	●	●					
								3 wire (NPN)	5V, 12V	H7NW	F7NWV	F79W	●	●			○	—						
										3 wire (PNP)	H7PW	—	F7PW	●			●	○	—					
	Diagnostic indication (2 color)	Grommet	Yes	2 wire	12V	—	5V, 12V	—	H7BW	H7BWV	J79W	●	●	○	—									
									Water resistant (2 color)	H7BA	—	F7BA	—	●	○	—								
														With timer	—	—	F7NT	—	●	○	—			
									With diagnostic output (2 color)	5V, 12V	H7NF	—	F79F		●	●	○	—						
											Latch with diagnostic output (2 color)	—	H7LF	—	F7LF	●	●	○	—					

### Part No. of Cylinder with Built-in Magnet

Symbol “-A” (rail mounting) or “-B” (band mounting) should be suffixed to the part No. of the cylinder with auto switch.

Ex.	Rail mounting	CDJ2RA16-60S-A
	Band mounting	CDJ2RA10-45S-B

\* Lead wire length 0.5m..... e.g.) C73C 5m.....Z e.g.) C73CZ  
3m.....L C73CL None.....N C73CN

\* Solid state switches marked with “○” are manufactured upon receipt of order.

# Series CJ2R

**Square rod cover makes direct contact mounting possible.**

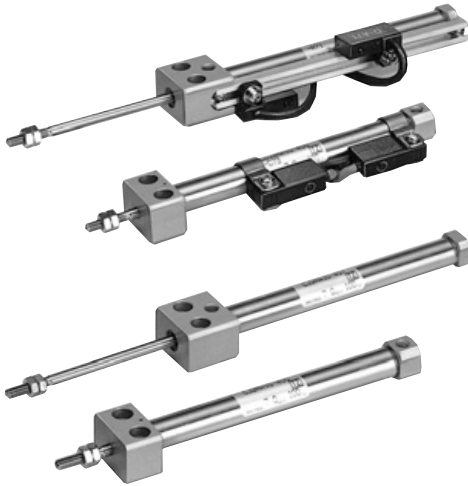

## JIS symbol

Single acting/  
Spring return

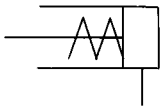

Single acting/  
Spring extend

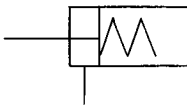

## ⚠ Precautions

**Refer to p.1.3-21 before handling.**

## Specifications

Action	Single acting/Spring return	Single acting/Spring extend
Fluid	Air	
Proof pressure	1.05MPa	
Max. operating pressure	0.7MPa	
Min. operating pressure	0.15MPa	
Ambient and fluid temperature	Without auto switch: -10°C to 70°C, With auto switch: -10°C to 60°C*	
Cushion	Rubber bumper	
Lubrication	Non-lube	
Thread tolerance	JIS class 2	
Stroke tolerance	+1.0 0	
Bore size (mm)	ø10, ø16	
Mounting	Bottom mounting	
Piston speed	50 to 750mm/s	
Allowable kinetic energy	ø10	0.035J
	ø16	0.090J

\* No freezing

## Standard Stroke

Bore size	Standard stroke (mm)
10	15, 30, 45, 60
16	15, 30, 45, 60, 75, 100, 125, 150

## Minimum Stokes for Auto Switch Mounting

•Refer to p.1.3-57.

## Accessory/Refer to p.1.3-12 for details.

Standard	Rod end nut
Option	Single knuckle joint, Double knuckle joint*

\* Double knuckle joint is packaged with pins and rings.

## Auto Switch Mounting Bracket Part No. (Band mounting)

Bore size (mm)	Bracket part No.	Note
10	BJ2-010	Common use to all of D-C7, C8 and D-H7
16	BJ2-016	



Note) A set of stainless steel mounting screws "BBA4" is attached. (A switch mounting band is not attached. Please order the band separately.) "BBA4" screws are used for D-C7/C8/H7. "D-H7BAL" switch is set on the cylinder with the screws above when shipped. Also, when a switch only is shipped, "BBA4" screws are attached.

## Spring Force

Bore size (mm)	Spring Force (N)	
	Retracted side	Extended side
10	6.86	3.53
16	14.2	6.86

# Direct Mount: Single Acting Spring Return/Extend *Series CJ2R*

## Weight

### Spring Return

Bore size (mm)		ø10	ø16
Weight*	15 Stroke	38	73
	30 Stroke	45	90
	45 Stroke	54	112
	60 Stroke	63	134
	75 Stroke	—	155
	100 Stroke	—	198
	125 Stroke	—	234
	150 Stroke	—	260

\* This weight includes weight of rod end nut.

### Spring Extend

Bore size (mm)		ø10	ø16
Weight*	15 Stroke	44	78
	30 Stroke	50	94
	45 Stroke	59	114
	60 Stroke	67	135
	75 Stroke	—	154
	100 Stroke	—	192
	125 Stroke	—	226
	150 Stroke	—	250

\* This weight includes weight of rod end nut.

## Construction (The cylinder cannot be disassembled.)

### CJ2RA□-□S

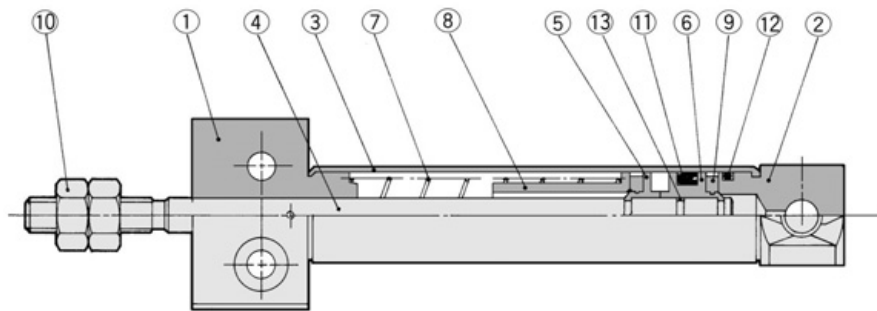
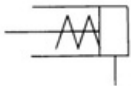

### CJ2RA□-□T

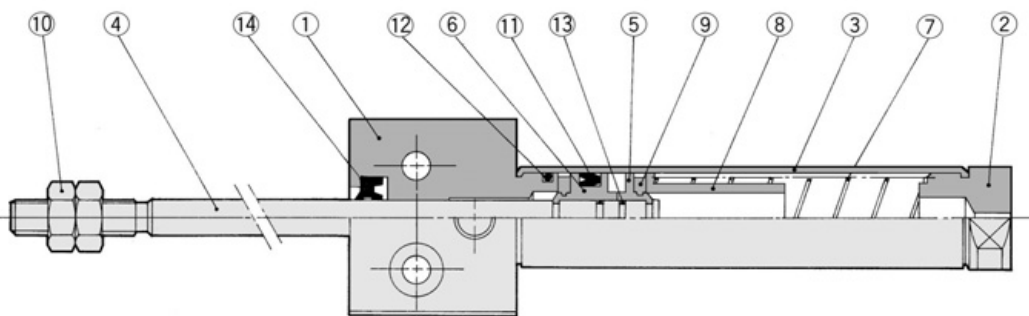
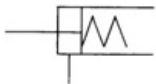

## Component Parts

No.	Description	Material	Note
①	Rod cover	Aluminum alloy	White anodized
②	Head cover	Aluminum alloy	White anodized
③	Cylinder tube	Stainless steel	
④	Piston rod	Stainless steel	
⑤	Piston A	Brass	
⑥	Piston B	Brass	
⑦	Return spring	Piano wire	

No.	Description	Material	Note
⑧	Spring seat	Brass	
⑨	Bumper	Urethane	
⑩	Rod end nut	Rolled steel	Nickel plated
⑪	Piston seal	NBR	
⑫	Tube gasket	NBR	
⑬	Piston gasket	NBR	
⑭	Rod seal	NBR	

CJ1

CJP

**CJ2**

CM2

C85

CG1

MB

C95

CA1

CS1

# Series CJ2R

## Single Acting/Bottom Mounting

Spring return/CJ2RA **Bore size** **Stroke** **S** **Port location on head cover**

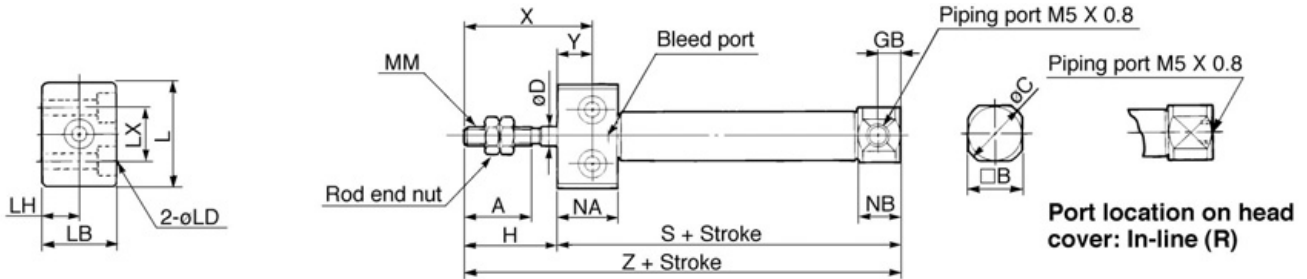

Spring extend/CJ2RA **Bore size** **Stroke** **T**

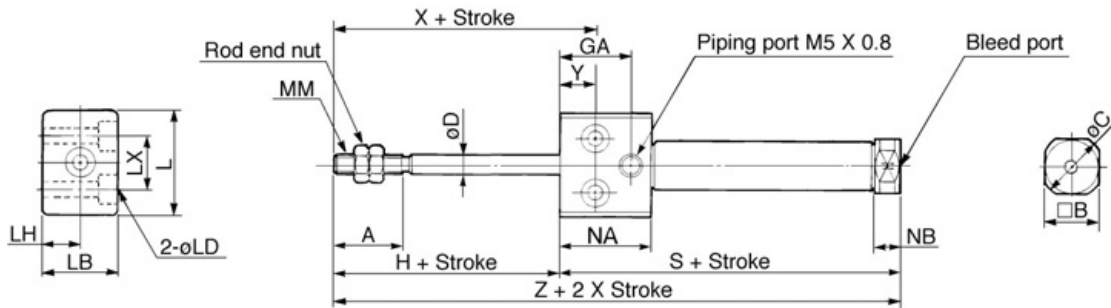

Rod end nut

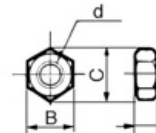

Material: Iron

Part No.	Bore	B	C	d	H
NTJ-010A	10	7	8.1	M4 X 0.7	3.2
NTJ-015A	16	8	9.2	M5 X 0.8	4

Bore	A	B	C	D	GB	H	L	LB	LD	LH	LX	MM	NA	NB	X	Y
10	15	12	14	4	5	20	23	16	ø3.5, ø6.5 Depth of counter bore: 4	8	12	M4 X 0.7	13.5	9.5	28	8
16	15	18	20	5	5	20	26	20	ø4.5, ø8 Depth of counter bore: 5	10	16	M5 X 0.8	13.5	9.5	28	8

### Dimensions by stroke/Spring return

Symbol Stroke	S								Z							
	5 to 15	16 to 30	31 to 45	46 to 60	61 to 75	76 to 100	101 to 125	126 to 150	5 to 15	16 to 30	31 to 45	46 to 60	61 to 75	76 to 100	101 to 125	126 to 150
10	53.5	61	73	85	—	—	—	—	73.5	81	93	105	—	—	—	—
16	53.5	62	74	86	92	116	134	146	73.5	82	94	106	112	136	154	166

### Dimensions by stroke/Spring extend (Dimensions not mentioned in the below table are the same as the above table.)

Bore	GA	NA	NB	S								Z							
				5 to 15	16 to 30	31 to 45	46 to 60	61 to 75	76 to 100	101 to 125	126 to 150	5 to 15	16 to 30	31 to 45	46 to 60	61 to 75	76 to 100	101 to 125	126 to 150
10	16	20.5	5.5	56.5	64	76	88	—	—	—	—	76.5	84	96	108	—	—	—	—
16	16	20.5	5.5	56.5	65	77	89	95	119	137	149	76.5	85	97	109	115	139	157	169



# Non-rotating Rod/Direct Mount: Double Acting Single Rod

# Series CJ2RK



ø10, ø16

## How to Order

**Bore size**

10	10mm
16	16mm

**Standard stroke (mm)**

ø10	15, 30, 45, 60, 75, 100, 125, 150
ø16	15, 30, 45, 60, 75, 100, 125, 150, 175, 200

**Mounting**

A	Bottom mounting
---	-----------------

**Standard**  
CJ2RKA 16-60

**With auto switch**  
CDJ2RKA 16-60-C73

**With auto switch (built-in magnet)**

**Port location on head cover**

Symbol	Port location
—	Perpendicular
R	In-line

\* Refer to p.1.3-67 for the configuration.

**Auto switch**

- \* Refer to the table below for selecting applicable auto switches.
- \* If requiring a built-in-magnet cylinder without an auto switch, refer to the model number example below.

**Number of switches**

—	2
S	1
n	n

- CJ1
- CJP
- CJ2**
- CM2
- C85
- CG1
- MB
- C95
- CA1
- CS1

### Applicable Auto Switches/Refer to p.5.3-2 for further information on auto switch.

Style	Special function	Electrical entry	Indicator	Wiring (Output)	Load voltage		Auto switch model		Lead wire* (m)				Applicable load													
					DC	AC	Band	Rail		0.5 (-)	3 (L)	5 (Z)	None (N)	IC	Relay PLC											
								Perp.	In-line																	
Reed switch	—	Grommet	Yes	3 wire (NPN)	—	5V	—	C76	—	A76H	●	●	—	—	IC	—										
											24V	2 wire	5V, 12V ≤100V	C73	A73	A73H	●	●	●	—	—	—				
																	12V	—	C73C	A73C	—	●	●	●	●	—
																						5V, 12V ≤24V	—	C80C	A80C	—
																	—	—	—	A79W	—					
											Solid state switch	—	Grommet	Yes	3 wire (NPN)	5V, 12V						—	H7A1	F7NV	F79	●
24V	3 wire (PNP)	—	H7A2	F7PV	F7P	●	●	○	—	—																
						12V	—	H7B	F7BV	J79							●	●	○	—	—					
																	—	—	H7C	J79C	—					●
24V	3 wire (NPN)	5V, 12V	H7NW	F7NWV	F79W	●	●	○	—	—																
						3 wire (PNP)	—	H7PW	—	F7PW							●	●	○	—	—					
																	2 wire	12V	—	H7BW	H7BWV					J79W
						—	—	—	H7BA	—																
24V	3 wire (NPN)	5V, 12V	—	—	F7NT												—	●	○	—	—					
						4 wire (NPN)	—	—	H7NF	—							F79F	●	●	○	—					—
											—	—	—	H7LF	—	F7LF		●	●	○	—	—				

### Part No. of Cylinder with Built-in Magnet

Symbol “-A” (rail mounting) or “-B” (band mounting) should be suffixed to the part No. of the cylinder with auto switch.

Ex.	Mounting	Part No.
	Rail mounting	CDJ2RKA16-60-A
	Band mounting	CDJ2RKA10-45-B

\* Lead wire length 0.5m.....— e.g.) C73C 5m.....-Z e.g.) C73CZ  
3m.....-L C73CL None.....-N C73CN

\* Solid state switches marked with “○” are manufactured upon receipt of order.

# Series CJ2RK

## Non-rotating rod with hexagon rod.

### High non-rotating accuracy

ø10: ±1.5°, ø16: ±1°

Auto switch can be mounted to detect the cylinder stroke position.

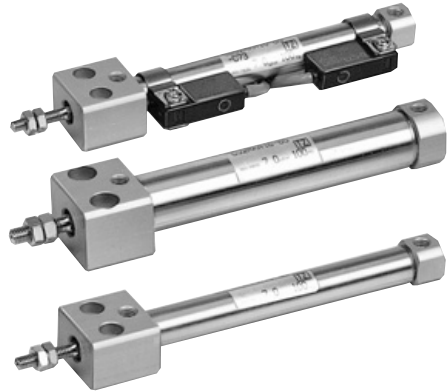

### JIS symbol

Double acting/Single rod

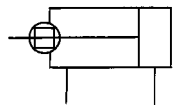

## ⚠ Precautions

Refer to p.0-39 to 0-46 before handling.

## Specifications

Action	Double acting/Single rod	
Fluid	Air	
Proof pressure	1.05MPa	
Max. operating pressure	0.7MPa	
Min. operating pressure	0.06MPa	
Ambient and fluid temperature	Without auto switch: -10°C to 70°C, With auto switch: -10°C to 60°C*	
Cushion	Rubber bumper	
Lubrication	Non-lube	
Thread tolerance	JIS class 2	
Stroke tolerance	+1.0 0	
Non-rotating accuracy	ø10: ±1.5°, ø16: ±1°	
Mounting	Bottom mounting	
Piston speed	50 to 750mm/s	
Allowable kinetic energy	ø10	0.035J
	ø16	0.090J

\* No freezing

## Standard Stroke

(mm)

Bore size	Standard stroke
10	15, 30, 45, 60, 75, 100, 125, 150
16	15, 30, 45, 60, 75, 100, 125, 150, 175, 200

## Minimum Strokes for Auto Switch Mounting

•Refer to p.1.3-57.

## Accessory/Refer to p.1.3-12 for details.

Standard	Rod end nut
Option	Single knuckle joint, Double knuckle joint*

\* Double knuckle joint is packaged with pins and rings.

# Non-rotating Rod/Direct Mount: Double Acting Single Rod *Series CJ2RK*

## Weight

Bore size (mm)	10	16
Basic weight*	36	71.5
Additional weight for each 15 of stroke	4	6.5

\* This basic weight includes weight of rod end nut.

Calculation example: CJ2RKA10-45

- Basic weight: ..... 36 (ø10)
  - Additional weight: ..... 4/15 stroke
  - Cylinder stroke: ..... 45 stroke
- $36 + 4/15 \times 45 = 48g$

## Port Location on Head Cover

Either perpendicular to the cylinder axis or in-line with the cylinder axis is available for basic.



In-line



Perpendicular

## Auto Switch Mounting Bracket Part No. (Band mounting)

Bore size (mm)	Bracket part No.	Note
10	BJ2-010	Common use to all of D-C7, C8 and D-H7
16	BJ2-016	

Note) A set of stainless steel mounting screws "BBA4" is attached. (A switch mounting band is not attached. Please order the band separately.) "BBA4" screws are used for D-C7/C8/H7. "D-H7BAL" switch is set on the cylinder with the screws above when shipped. Also, when a switch only is shipped, "BBA4" screws are attached.

## ⚠ Caution

### Precautions on handling

#### <Mounting>

• Avoid using the air cylinder in such a way that rotational torque would be applied to the piston rod because this will deform the non-rotating guide, thus affecting the non-rotating accuracy. Refer to the table below for the approximate values of the allowable range of rotational torque.

Allowable rotational torque (Nm)	ø10	ø16
	0.02	0.04

- Operate the cylinder in such a way that the load to the piston rod is always applied in the axial direction.
- To screw a bracket onto the threaded portion at the tip of the piston rod, make sure to retract the piston rod entirely, and place a wrench over the flat portion of the rod that protrudes. To tighten, take precautions to prevent the tightening torque from being applied to the non-rotating guide.

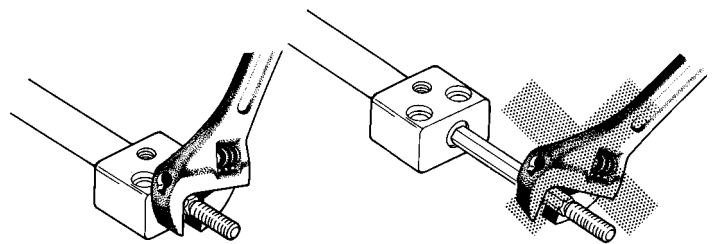

CJ1

CJP

CJ2

CM2

C85

CG1

MB

C95

CA1

CS1

## Construction (The cylinder cannot be disassembled.)

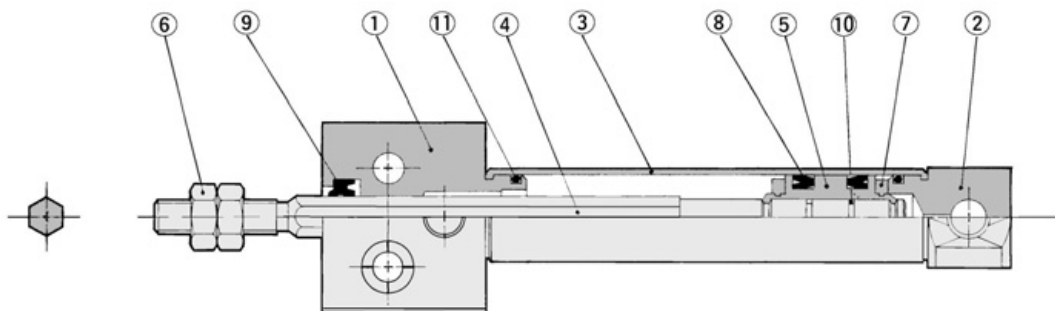
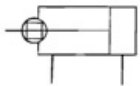

## Component Parts

No.	Description	Material	Note
①	Rod cover	Aluminum alloy	White anodized
②	Head cover	Aluminum alloy	White anodized
③	Cylinder tube	Stainless steel	
④	Piston rod	Stainless steel	
⑤	Piston	Brass	
⑥	Rod end nut	Rolled steel	Nickel plated

No.	Description	Material	Note
⑦	Bumper	Urethane	
⑧	Piston seal	NBR	
⑨	Rod seal	NBR	
⑩	Piston gasket	NBR	
⑪	Tube gasket	NBR	

# Series CJ2RK

Bottom Mounting



CJ2RKA **Bore size** **Stroke** **Port location on head cover**

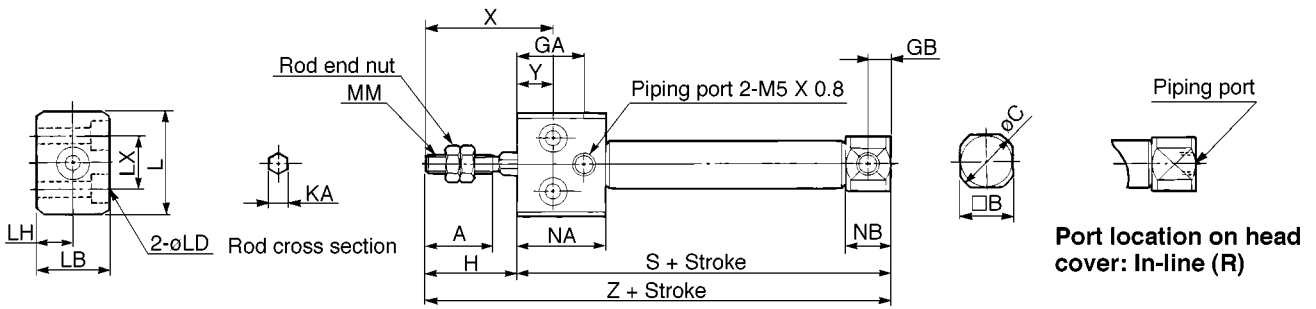

## Rod end nut

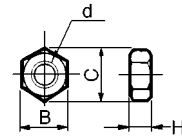

Material: Iron

Part No.	Bore size	B	C	d	H
NTJ-010A	10	7	8.1	M4 X 0.7	3.2
NTJ-015A	16	8	9.2	M5 X 0.8	4

Bore	A	B	C	GA	GB	H	KA	L	LB	LD	LH	LX	MM	NA	NB	X	Y	S	Z
10	15	12	14	16	5	20	4.2	23	16	ø3.5, ø6.5 Depth of counter bore: 4	8	12	M4 X 0.7	20.5	9.5	28	8	54	74
16	15	18	20	16	5	20	5.2	26	20	ø4.5, ø8 Depth of counter bore: 5	10	16	M5 X 0.8	20.5	9.5	28	8	55	75

(mm)



Bottom mounting  
 CJ2RKA10 ..... SCJ210, #10  
 CJ2RKA16 ..... SCJ216, #10

\* The data shows auto switch styles.  
 Please delete the unnecessary parts.

# Non-rotating Rod/Direct Mount: Single Acting Spring Return/Extend

## Series CJ2RK

ø10, ø16

### How to Order

**Standard**  
CJ2RKA 16-45 S

**With auto switch**  
CDJ2RKA 16-45 S C73

**Bore size**

10	10mm
16	16mm

**Standard stroke (mm)**

ø10	15, 30, 45, 60
ø16	15, 30, 45, 60, 75, 100, 125, 150

**Mounting**

A	Bottom mounting
---	-----------------

**Action**

S	Single acting/Spring return
T	Single acting/Spring extend

**Port location on head cover**

Symbol	Port location
—	Perpendicular
R	In-line

**Number of switches**

—	2
S	1
n	n

**Auto switch**

- \* Refer to the table below for selecting applicable auto switches.
- \* If requiring a built-in magnet cylinder without an auto switch, refer to the model number example below.

**With auto switch (built-in magnet)**

\* Refer to p.1.3-67 for the configuration.  
\* Not applicable to single acting/spring extend (T).

- CJ1
- CJP
- CJ2**
- CM2
- C85
- CG1
- MB
- C95
- CA1
- CS1

### Applicable Auto Switches/Refer to p.5.3-2 for further information on auto switch.

Style	Special function	Electrical entry	Indicator	Wiring (Output)	Load voltage		Auto switch model			Lead wire* (m)				Applicable load																							
					DC	AC	Band	Rail		0.5 (-)	3 (L)	5 (Z)	None (N)	IC	Relay PLC																						
Reed switch	—	Grommet	Yes	3 wire (NPN)	—	5V	—	C76	—	A76H	●	●	—			—	IC	—																			
											24V	—	A72	A72H	●	●			—	—																	
															12V	100V			C73	A73	A73H	●	●	●	—												
																						5V, 12V	≤100V	C80	A80	A80H	●	●	—	—							
																											12V	—	C73C	A73C	—	●	●	●	●		
																																5V, 12V	≤24V	C80C	A80C	—	●
—	—	A79W	—	●	●	—	—																														
				Solid state switch	—	Grommet	Yes	3 wire (NPN)	5V, 12V	—	H7A1	F7NV	F79	●			●	○																			—
														3 wire (PNP)	—	H7A2	F7PV	F7P	●	●	○																—
																			2 wire	12V	—	H7B	F7BV	J79	●	●											○
																									3 wire (NPN)	5V, 12V	—	H7C	J79C	—	●						●
																															3 wire (PNP)	—	H7NW	F7NWV	F79W	●	●
24V	—	H7PW	—																																	F7PW	●
				2 wire	12V	—	H7BW	H7BWV	J79W	●	●	○	—																								
										Water resistant (2 color)	Grommet	Yes	2 wire	12V	—	H7BA	—	F7BA																			—
																			With timer	—	—	—	—	F7NT													—
																									With diagnostic output (2 color)	5V, 12V	—	H7NF	—	F79F							●
																															Latch with diagnostic output (2 color)	—	—	H7LF	—		F7LF

### Part No. of Cylinder with Built-in Magnet

Symbol "A" (rail mounting) or "B" (band mounting) should be suffixed to the part No. of the cylinder with auto switch.

Ex.	Rail mounting	CDJ2RKA16-60S-A
	Band mounting	CDJ2RKA10-45S-B

\* Lead wire length 0.5m.....— e.g.) C73C 5m.....Z e.g.) C73CZ  
3m.....L C73CL None.....N C73CN

\* Solid state switches marked with "○" are manufactured upon receipt of order.

# Series CJ2RK

## Non-rotating rod with hexagon rod.

### High non-rotating accuracy

ø10: ±1.5°, ø16: ±1°

### No lubrication required

Auto switch can be mounted to detect the cylinder stroke position.



## JIS symbol

Single acting/  
Spring return

Single acting/  
Spring extend

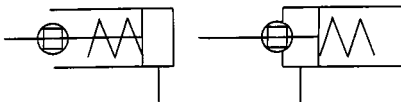

## ⚠ Precautions

Refer to p.1.3-36 before handling.

## Specifications

Action	Single acting/Spring return	Single acting/Spring extend
Fluid	Air	
Proof pressure	1.05MPa	
Max. operating pressure	0.7MPa	
Min. operating pressure	0.15MPa	
Ambient and fluid temperature	Without auto switch: -10°C to 70°C, With auto switch: -10°C to 60°C*	
Cushion	Rubber bumper	
Lubrication	Non-lube	
Thread tolerance	JIS class 2	
Stroke tolerance	+1.0 0	
Non-rotating accuracy	ø10: ±1.5°, ø16: ±1°	
Mounting	Bottom mounting	
Bore size (mm)	ø10, ø16	
Piston speed	50 to 750mm/s	
Allowable kinetic energy	ø10	0.035J
	ø16	0.090J

\* No freezing

## Standard Stroke

(mm)

Bore size	Standard stroke
10	15, 30, 45, 60
16	15, 30, 45, 60, 75, 100, 125, 150

## Minimum Strokes for Auto Switch Mounting

- Refer to p.1.3-57.

## Accessory/Refer to p.1.3-12 for details.

Standard	Rod end nut
Option	Single knuckle joint, Double knuckle joint*

\* Double knuckle joint is packaged with pins and rings.

## Auto Switch Mounting Bracket Part No. (Band mounting)

Bore size (mm)	Bracket part No.	Note
10	BJ2-010	Common use to all of D-C7, C8 and D-H7
16	BJ2-016	



Note) A set of stainless steel mounting screws "BBA4" is attached. (A switch mounting band is not attached. Please order the band separately.) "BBA4" screws are used for D-C7/C8/H7. "D-H7BAL" switch is set on the cylinder with the screws above when shipped. Also, when a switch only is shipped, "BBA4" screws are attached.

## Spring Force

(N)

Bore size (mm)	Retracted side	Extended side
10	6.86	3.53
16	14.2	6.86

# Non-rotating Rod/Direct Mount: Double Acting Spring Return/Extend *Series CJ2R*

## Weight

### Spring Return

Bore size (mm)		(g)	
		ø10	ø16
Weight*	15 Stroke	38	73
	30 Stroke	45	90
	45 Stroke	54	112
	60 Stroke	63	134
	75 Stroke	—	155
	100 Stroke	—	198
	125 Stroke	—	234
	150 Stroke	—	260

\* This weight includes weight of rod end nut.

### Spring Extend

Bore size (mm)		(g)	
		ø10	ø16
Weight*	15 Stroke	44	78
	30 Stroke	50	94
	45 Stroke	59	114
	60 Stroke	67	135
	75 Stroke	—	154
	100 Stroke	—	192
	125 Stroke	—	226
	150 Stroke	—	250

\* This weight includes weight of rod end nut.

## Construction (The cylinder cannot be disassembled.)

### Single acting/Spring return

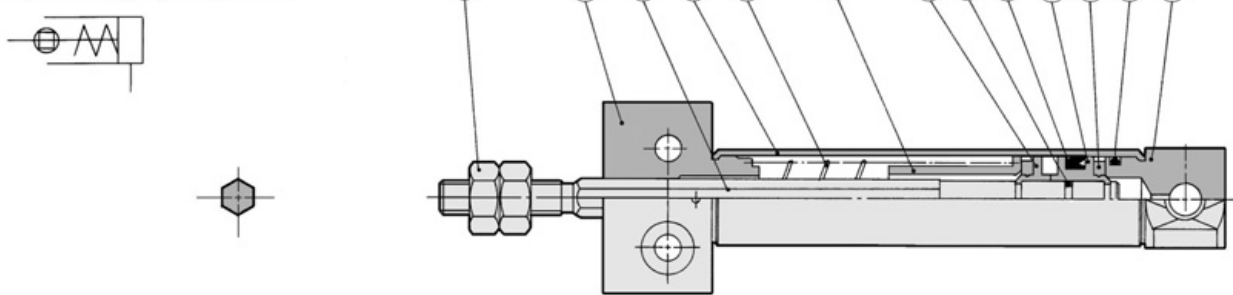

### Single acting/Spring extend

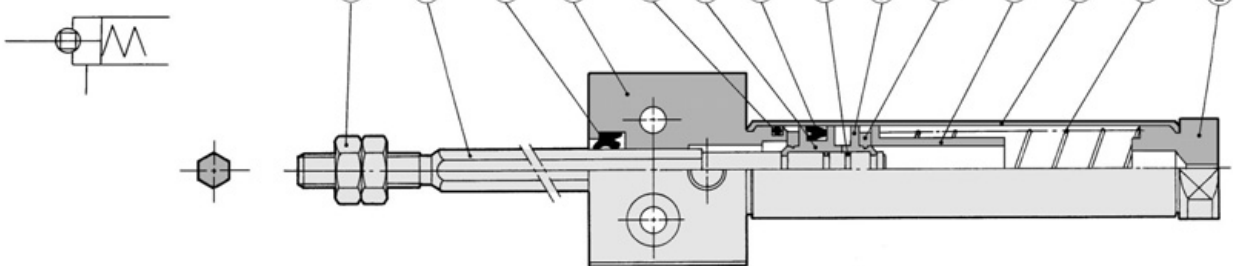

## Component Parts

No.	Description	Material	Note
①	Rod cover	Aluminum alloy	White anodized
②	Head cover	Aluminum alloy	White anodized
③	Cylinder tube	Stainless steel	
④	Piston rod	Stainless steel	
⑤	Piston A	Brass	
⑥	Piston B	Brass	
⑦	Return spring	Piano wire	
⑧	Spring seat	Brass	

No.	Description	Material	Note
⑨	Bumper	Urethane	
⑩	Rod end nut	Rolled steel	Nickel plated
⑪	Piston seal	NBR	
⑫	Tube gasket	NBR	
⑬	Piston gasket	NBR	
⑭	Rod seal	NBR	

CJ1

CJP

CJ2

CM2

C85

CG1

MB

C95

CA1

CS1

# Series CJ2RK

## Single Acting/Bottom Mounting

Spring return/CJ2RK **Bore size** **Stroke** **S** **Port location on head cover**

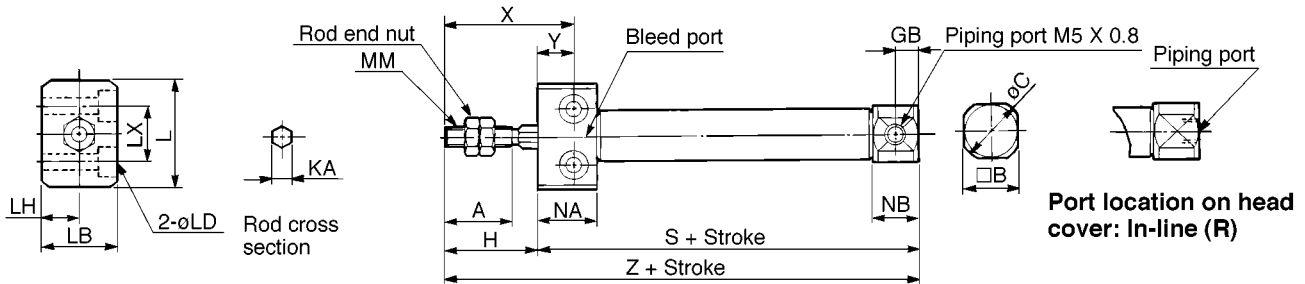

Spring extend/CJ2RK **Bore size** **Stroke** **T**

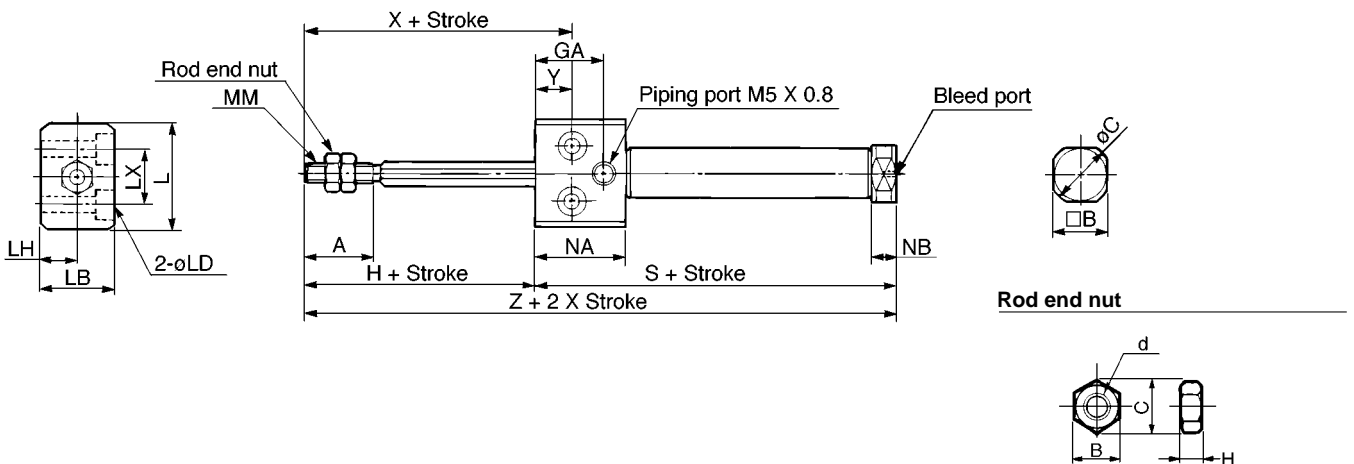

Material: Iron

Part No.	Bore	B	C	d	H
NTJ-010A	10	7	8.1	M4 X 0.7	3.2
NTJ-015A	16	8	9.2	M5 X 0.8	4

Bore	A	B	C	GB	H	KA	L	LB	LD	LH	LX	MM	NA	NB	X	Y
10	15	12	14	5	20	4.2	23	16	ø3.5, ø6.5 Depth of counter bore: 4	8	12	M4 X 0.7	13.5	9.5	28	8
16	15	18	20	5	20	5.2	26	20	ø4.5, ø8 Depth of counter bore: 5	10	16	M5 X 0.8	13.5	9.5	28	8

### Dimensions by stroke/Spring return

Symbol Stroke	S								Z							
	5 to 15	16 to 30	31 to 45	46 to 60	61 to 75	76 to 100	101 to 125	126 to 150	5 to 15	16 to 30	31 to 45	46 to 60	61 to 75	76 to 100	101 to 125	126 to 150
10	53.5	61	73	85	—	—	—	—	73.5	81	93	105	—	—	—	—
16	53.5	62	74	86	92	116	134	146	73.5	82	94	106	112	136	154	166

### Dimensions by stroke/Spring extend (Dimensions not mentioned in the below table are the same as the above table.)

Bore	GA	NA	NB	S								Z							
				5 to 15	16 to 30	31 to 45	46 to 60	61 to 75	76 to 100	101 to 125	126 to 150	5 to 15	16 to 30	31 to 45	46 to 60	61 to 75	76 to 100	101 to 125	126 to 150
10	16	20.5	5.5	56.5	64	76	88	—	—	—	—	76.5	84	96	108	—	—	—	—
16	16	20.5	5.5	56.5	65	77	89	95	119	137	149	76.5	85	97	109	115	139	157	169



# World Wide SMC Support...

**North American Branch Offices** For a branch office near you call: 1-800-SMC-SMC1 (762-7621)

**SMC Pneumatics Inc. (Atlanta)**  
1440 Lakes Parkway, Suite 600  
Lawrenceville, GA 30043  
Tel: (770) 624-1940  
FAX: (770) 624-1943

**SMC Pneumatics Inc. (Cleveland)**  
2305 East Aurora Rd., Unit A-3  
Twinsburg, OH 44087  
Tel: (330) 963-2727  
FAX: (330) 963-2730

**SMC Pneumatics Inc. (Milwaukee)**  
16850 W. Victor Road  
New Berlin, WI 53151  
Tel: (414) 827-0080  
FAX: (414) 827-0092

**SMC Pneumatics Inc. (Richmond)**  
5377 Glen Alden Drive  
Richmond, VA 23231  
Tel: (804) 222-2762  
FAX: (804) 222-5221

**SMC Pneumatics Inc. (Austin)**  
2324-D Ridgepoint Drive  
Austin, TX 78754  
Tel: (512) 926-2646  
FAX: (512) 926-7055

**SMC Pneumatics Inc. (Columbus)**  
3687 Corporate Drive  
Columbus, OH 43231  
Tel: (614) 895-9765  
FAX: (614) 895-9780

**SMC Pneumatics Inc. (Mnpls.)**  
990 Lone Oak Road, Suite 162  
Eagan, MN 55121  
Tel: (651) 688-3490  
FAX: (651) 688-9013

**SMC Pneumatics Inc. (Rochester)**  
245 Summit Point Drive  
Henrietta, NY 14467  
Tel: (716) 321-1300  
FAX: (716) 321-1865

**SMC Pneumatics Inc. (Boston)**  
Zero Centennial Drive  
Peabody, MA 01960  
Tel: (978) 326-3600  
Fax: (978) 326-3700

**SMC Pneumatics Inc. (Dallas)**  
12801 N. Stemmons Frwy, Ste. 815  
Dallas, TX 75234  
Tel: (972) 406-0082  
FAX: (972) 406-9904

**SMC Pneumatics Inc. (Nashville)**  
5000 Linbar Drive, Suite 297  
Nashville, TN 37211  
Tel: (615) 331-0020  
FAX: (615) 331-9950

**SMC Pneumatics Inc. (S.F.)**  
85 Nicholson Lane  
San Jose, CA 95134  
Tel: (408) 943-9600  
FAX: (408) 943-9111

**SMC Pneumatics Inc. (Charlotte)**  
5029-B West W.T. Harris Blvd.  
Charlotte, NC 28269  
Tel: (704) 597-9292  
FAX: (704) 596-9561

**SMC Pneumatics Inc. (Detroit)**  
2990 Technology Drive  
Rochester Hills, MI 48309  
Tel: (248) 299-0202  
FAX: (248) 293-3333

**SMC Pneumatics Inc. (Newark)**  
3434 US Hwy. 22 West, Ste. 110  
Somerville, NJ 08876  
Tel: (908) 253-3241  
FAX: (908) 253-3452

**SMC Pneumatics Inc. (St. Louis)**  
4130 Rider Trail North  
Earth City, MO 63045  
Tel: (314) 209-0080  
FAX: (314) 209-0085

**SMC Pneumatics Inc. (Chicago)**  
27725 Diehl Road  
Warrenville, IL 60555  
Tel: (630) 393-0080  
FAX: (630) 393-0084

**SMC Pneumatics Inc. (Houston)**  
9001 Jameel, Suite 180  
Houston, TX 77040  
Tel: (713) 460-0762  
FAX: (713) 460-1510

**SMC Pneumatics Inc. (Phoenix)**  
2001 W. Melinda Lane  
Phoenix, AZ 85027  
Tel: (623) 492-0908  
FAX: (623) 492-9493

**SMC Pneumatics Inc. (Tampa)**  
8507-H Benjamin Road  
Tampa, FL 33634  
Tel: (813) 243-8350  
FAX: (813) 243-8621

**SMC Pneumatics Inc. (Cincinnati)**  
4598 Olympic Blvd.  
Erlanger, KY 41018  
Tel: (606) 647-5600  
FAX: (606) 647-5609

**SMC Pneumatics Inc. (L.A.)**  
14191 Myford Road  
Tustin, CA 92780  
Tel: (714) 669-1701  
FAX: (714) 669-1715

**SMC Pneumatics Inc. (Portland)**  
14107 N.E. Airport Way  
Portland, OR 97230  
Tel: (503) 252-9299  
FAX: (503) 252-9253

**SMC Pneumatics Inc. (Tulsa)**  
10203 A East 61st Street  
Tulsa, OK 74146  
Tel: (918) 252-7820  
FAX: (918) 252-9511

**Europe**  
ENGLAND  
**SMC Pneumatics (U.K.) Ltd.**  
GERMANY  
**SMC Pneumatik GmbH**  
ITALY  
**SMC Italia SpA**  
FRANCE  
**SMC Pneumatique SA**  
HOLLAND  
**SMC Controls BV**  
SWEDEN  
**SMC Pneumatics Sweden AB**  
SWITZERLAND  
**SMC Pneumatik AG**  
AUSTRIA  
**SMC Pneumatik GmbH**  
SPAIN  
**SMC España, S.A.**  
IRELAND  
**SMC Pneumatics (Ireland) Ltd.**  
**Asia**  
JAPAN

**SMC Corporation**  
KOREA  
**SMC Pneumatics Korea Co., Ltd.**  
CHINA  
**SMC (China) Co., Ltd.**  
HONG KONG  
**SMC Pneumatics (Hong Kong) Ltd.**  
SINGAPORE  
**SMC Pneumatics (S.E.A.) Pte. Ltd.**  
PHILIPPINES  
**SMC Pneumatics (Philippines), Inc.**  
MALAYSIA  
**SMC Pneumatics (S.E.A.) Sdn. Bhd.**  
TAIWAN  
**SMC Pneumatics (Taiwan) Co., Ltd.**  
THAILAND  
**SMC Thailand Ltd.**  
INDIA  
**SMC Pneumatics (India) Pvt., Ltd.**  
**North America**  
CANADA  
**SMC Pneumatics (Canada) Ltd.**  
MEXICO  
**SMC Pneumatics (Mexico) S.A. de C.V.**

**South America**  
ARGENTINA  
**SMC Argentina S.A.**  
CHILE  
**SMC Pneumatics (Chile) Ltda.**

**Oceania**  
AUSTRALIA  
**SMC Pneumatics (Australia) Pty. Ltd.**  
NEW ZEALAND  
**SMC Pneumatics (N.Z.) Ltd.**

## SMC offers the same quality and engineering expertise in many other pneumatic components

**Valves**  
Directional Control Valves  
Manual Valves  
Mufflers  
Exhaust Cleaners  
Quick Exhaust Valves

**Valves**  
Proportional Valves  
Mechanical Valves  
Miniature Valves  
Fluid Valves

**Cylinders/Actuators**  
Compact Cylinders  
Miniature Cylinders  
Rodless Cylinders  
Rotary Actuators  
Pneumatic Grippers

**Vacuum**  
Vacuum Ejectors  
Vacuum Accessories  
**Instrumentation**  
Pneumatic Positioners  
Pneumatic Transducers

**Air Preparation Equipment**  
Filters-Regulators-Lubricators  
Coalescing Filters  
Micro Mist Separators  
**Fittings**  
Air Fittings

## SMC Pneumatics Inc.

P.O. Box 26640, Indianapolis, IN 46226  
Tel: (317) 899-4440 • FAX: (317) 899-3102