

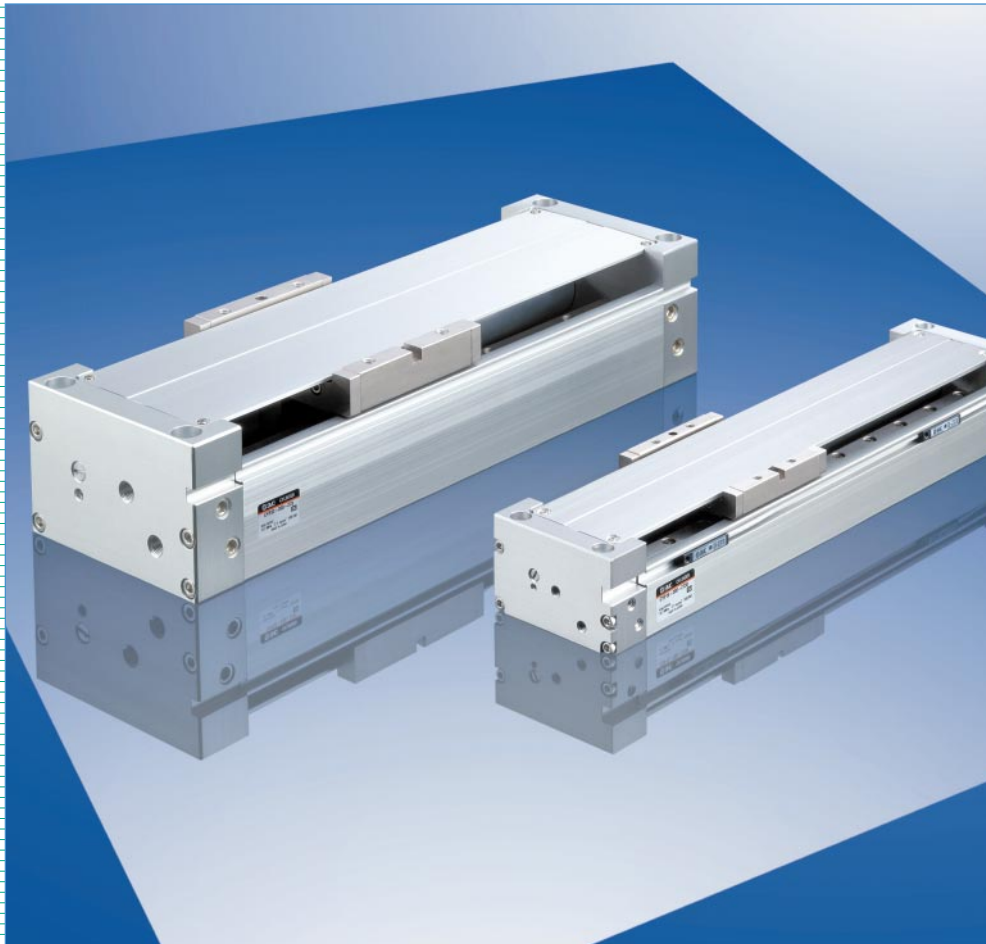

Clean Room Rodless Cylinder
CYP Series

ø15, ø32



- Magnetically Coupled Cylinder w/Guide
- Shock-Free Cushioning Structure
- Low Particulate Generation
- Cleaned, Assembled & Double Packaged in a Clean Room

Low particle generation: 1/20 (compared to previous series)

- High cleanliness is achieved with **non-contact construction** of the cylinder tube exterior and a **stainless steel linear guide (specially treated)**.
- Particle generation has been reduced to 1/20 compared to series 12-CY1B (previous SMC product) even without vacuum suction.

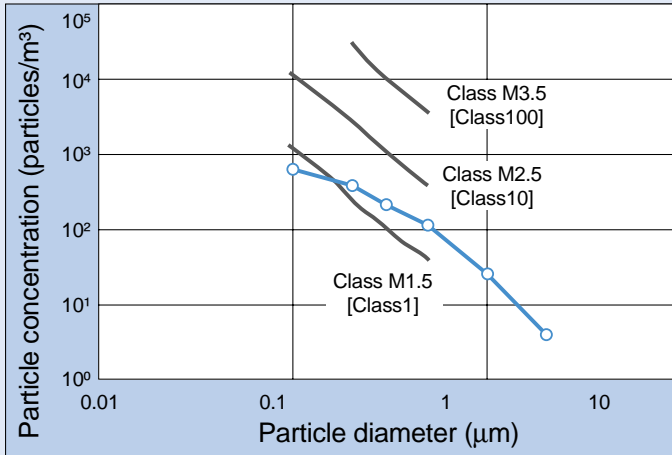

- Note 1) This chart indicates the level of cleanliness inside the measurement chamber.
 Note 2) The vertical axis shows the number of particles per unit volume (1m³) of air which are no smaller than the particle size shown on the horizontal axis.
 Note 3) The gray lines show the upper concentration limit of the cleanliness class based on Fed.Std.209E-1992.
 Note 4) The plots indicate the 95% upper reliability limit value for time series data up to 500 thousand operation cycles. (Cylinder: CYP32-200, Work piece weight: 5kg, Average speed: 2000mm/s)
 Note 5) The data above provide a guide for selection but is not guaranteed.

Long strokes (Max. 700mm)

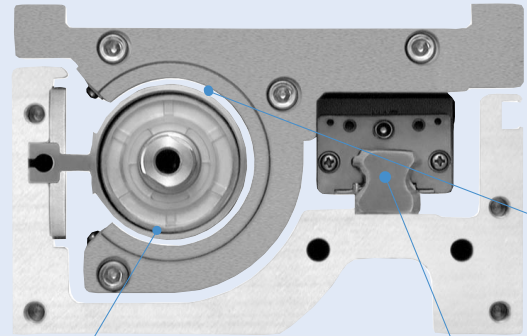

Stainless steel linear guide (specially treated)

The specially treated linear guide achieves low particulate generation, high linearity and high precision.

Non-contact construction

There is no particulate generation from sliding, because the construction avoids contact between the cylinder tube's exterior surface and the slide table's interior surface.

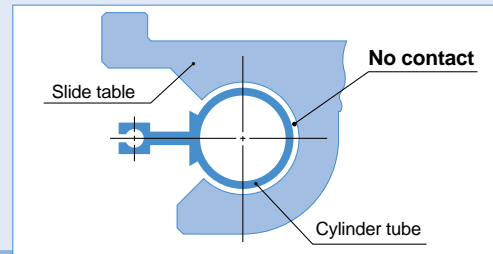

Piping port variations provide a high degree of freedom

Piping port positions can be selected to accommodate the installation.

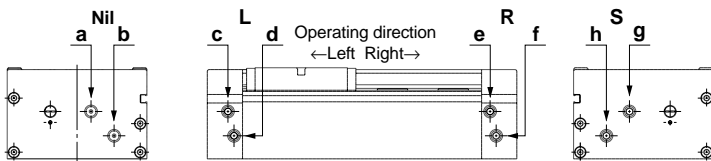

Note) Plugs are installed in ports other than those indicated for the model.

Model	Nil		L		R		S	
Piping port position	a	b	c	d	e	f	g	h
Operating direction	Right	Left	Right	Left	Right	Left	Right	Left

Cleaned, assembled and double packaged in a clean room

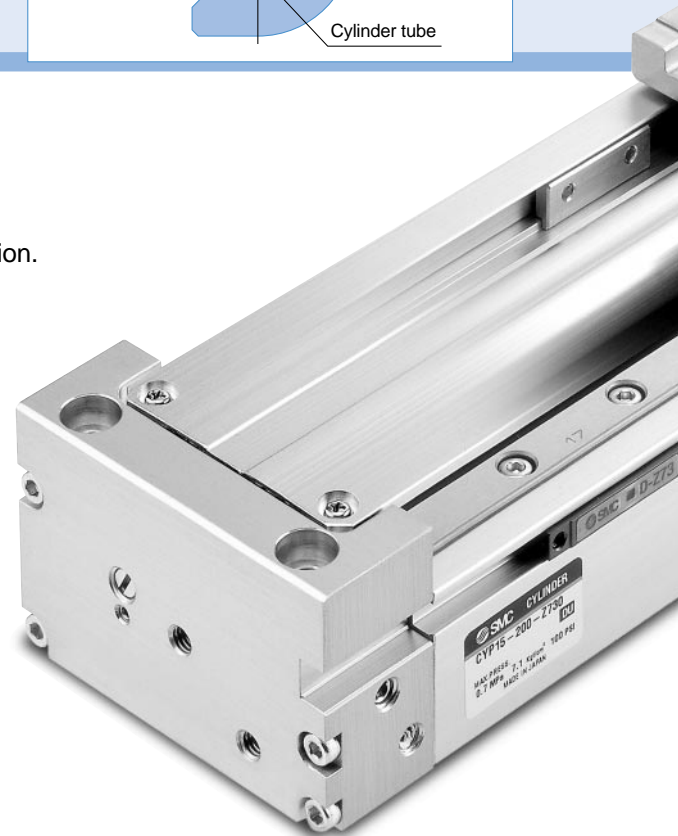

magnetically coupled rodless cylinder that can be used for transfer in clean environments

Special cylinder tube

A special cylinder tube is employed using extruded aluminum material. Even long strokes are not subject to deflection because of direct attachment to the cylinder body, and non-contact construction is achieved through combination with a linear guide.



Shock-free

A **sine cushion** is used at the end of the stroke. Smooth acceleration and deceleration are possible at 0.5G or less.

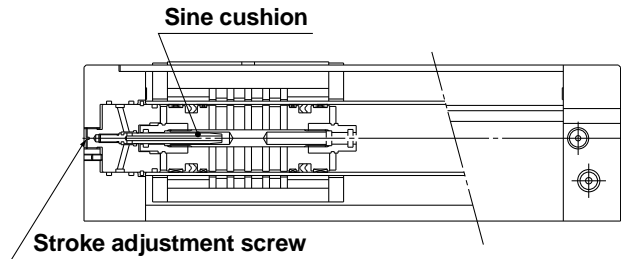

Stroke adjustment

The **stroke adjustment screw** allows fine control of the stroke ($\pm 1\text{mm}$ on each side)

Variations

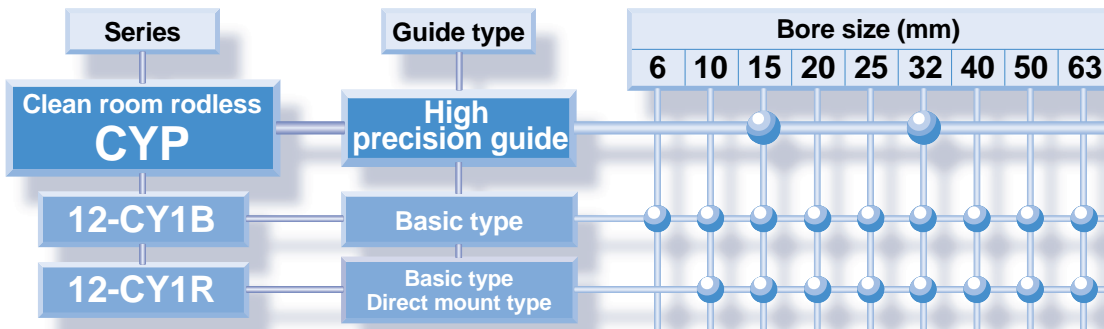

How to Order

CYP 15-200-□-Z73-□

Clean room rodless cylinder

Cylinder bore size

15	15mm
32	32mm

Standard stroke

Bore size (mm)	Standard stroke (mm)
15, 32	100, 150, 200, 250, 300, 350 400, 450, 500, 600, 700

Note 1) Consult SMC if the maximum stroke is exceeded.
Note 2) Intermediate strokes are available as a special order.

Number of auto switches

Nil	2 pcs.
S	1 pc.
n	"n" pcs.

Type of auto switch

Nil	Without auto switch
-----	---------------------

Select auto switches from the table below.

Piping port position

Nil	a	b	c	d	e	f	g	h
	Operating direction: Right		Operating direction: Left		Operating direction: Right		Operating direction: Left	
L	Operating direction: Right		Operating direction: Left		Operating direction: Right		Operating direction: Left	
R	Operating direction: Right		Operating direction: Left		Operating direction: Right		Operating direction: Left	
S	Operating direction: Right		Operating direction: Left		Operating direction: Right		Operating direction: Left	

Piping port position

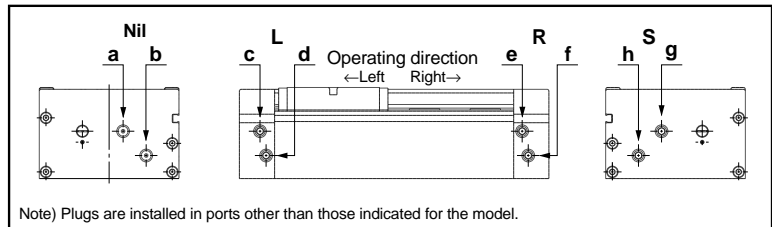

Applicable auto switches

Type	Special function	Electrical entry	Indicator light	Wiring (output)	Load voltage		Auto switch models		Lead wire length (mm)*			Applicable loads		Detailed specifications	
					DC	AC	Electrical entry direction	In-line	0.5 (Nil)	3 (L)	5 (Z)				
Reed switch	—	Grommet	Yes	3 wire	—	5V	—	—	Z76	●	●	—	IC circuit	Relay, PLC	P.8
				2 wire	24V	12V	100V	—	Z73	●	●	●	—		
				—	5V, 12V	100V or less	—	Z80	●	●	—	IC circuit			
Solid state switch	Diagnostic indication (2 color indicator)	Grommet	Yes	3 wire (NPN)	24V	5V, 12V	—	Y69A	Y59A	●	●	○	IC circuit	Relay, PLC	P.9
				3 wire (PNP)				Y7PV	Y7P	●	●	○	IC circuit		
				2 wire				Y69B	Y59B	●	●	○	—		
				3 wire (NPN)				Y7NWV	Y7NW	●	●	○	IC circuit		
				3 wire (PNP)				Y7PWV	Y7PW	●	●	○	IC circuit		
				2 wire				Y7BWV	Y7BW	●	●	○	—		

* Lead wire length symbols: 0.5m Nil (Example) Y69B
 3m L Y69BL
 5m Z Y69BZ

** Auto switches marked with a "O" symbol are produced upon receipt of order.



Specifications

Bore size (mm)	15	32
Fluid	Air and inert gases	
Action	Double acting	
Proof pressure	0.5MPa (72 psi)	
Operating pressure range	0.05 to 0.3MPa (7 to 43 psi)	
Ambient and fluid temperature	-10 to 60°C (14° to 140°F)	
Piston speed	50 to 300mm/s (2 to 11.8 in/s)	
Lubrication	Non-lube	
Stroke adjustment	±1mm on each side (±2mm total)	
Cushion	Sine cushion (Air cushion)	
Port size	M5 x 0.8 (10-32 nominal)	Rc 1/8

Weights

Model	Standard stroke (mm)										
	100	150	200	250	300	350	400	450	500	600	700
CYP15	1.2 (2.6)	1.4 (3.1)	1.6 (3.5)	1.7 (3.7)	1.9 (4.2)	2.0 (4.4)	2.2 (4.9)	2.4 (5.3)	2.5 (5.5)	2.8 (6.2)	3.2 (7.1)
CYP32	4.2 (9.3)	4.6 (10.1)	5.0 (11.0)	5.5 (12.1)	5.9 (13.0)	6.3 (13.9)	6.7 (14.8)	7.1 (15.7)	7.5 (16.5)	8.3 (18.3)	9.1 (20.1)

kg (lb)

1in = 25.4mm

Magnet Holding Force

Bore size (mm ²)	Magnet holding force N (lbf)
15	59 (13.3)
32	268 (60.2)

Theoretical Output

Bore size (mm)	Piston area (mm ²)	Operating pressure MPa (psi)		
		0.1(14.5)	0.2 (29)	0.3 (43.5)
15	176	18 (4.0)	35 (7.9)	53 (11.9)
32	804	80 (181.0)	161 (36.2)	241 (54.2)

1in = 25.4mm

Construction

CYP15

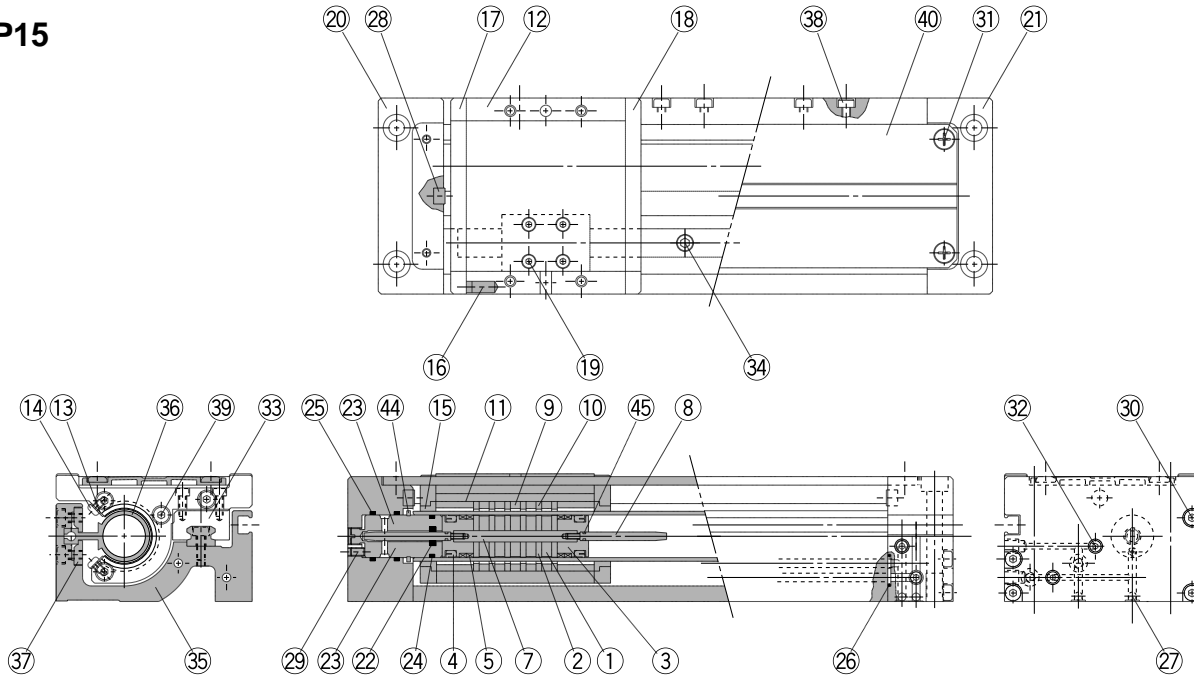

CYP32

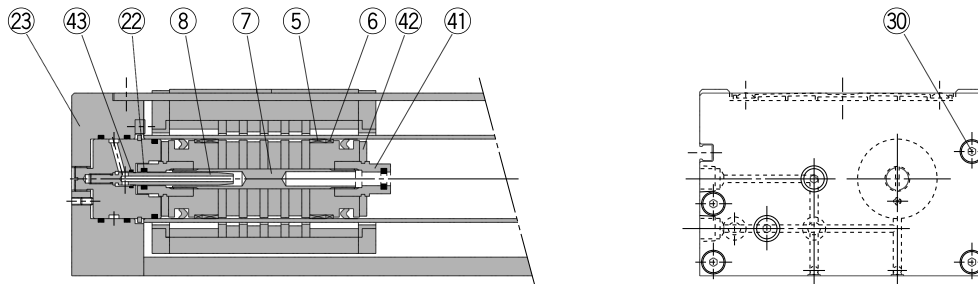

Parts list

No.	Description	Material	Note
1	Magnet A	Rare earth magnet	
2	Piston side yoke	Rolled steel plate	Zinc chromated
3	Piston	Brass/Aluminum alloy	ø15: Electroless nickel plated, ø32: Chromated
4	Piston seal	NBR	
5	Wear ring A	Special resin	
6	Wear ring	Special resin	
7	Shaft	Stainless steel	
8	Cushion ring	Stainless steel/Brass	ø15: Electroless nickel plated
9	Magnet B	Rare earth magnet	
10	External slider side yoke	Rolled steel	Electroless nickel plated
11	External spacer	Aluminum alloy	Electroless nickel plated
12	Slide table	Aluminum alloy	Electroless nickel plated
13	Insertion guide plate	Stainless steel	
14	Round head Phillips screw	Carbon steel	Nickel plated
15	Hold spacer	Aluminum alloy	Electroless nickel plated
16	Magnet	Rare earth magnet	
17	Side plate A	Aluminum alloy	Electroless nickel plated
18	Side plate B	Aluminum alloy	Electroless nickel plated
19	Hexagon socket head cap screw	Chrome molybdenum steel	Nickel plated
20	Plate A	Aluminum alloy	Clear hard anodized
21	Plate B	Aluminum alloy	Clear hard anodized
22	Cushion seal	NBR	

No.	Description	Material	Note
23	Inner cover	Aluminum alloy	Clear hard anodized
24	Cylinder tube gasket	NBR	
25	O-ring	NBR	
26	O-ring	NBR	
27	Steel ball	Carbon steel	
28	Bumper	Polyurethane	
29	Hexagon socket head set screw	Chrome molybdenum steel	Nickel plated
30	Hexagon socket head cap screw	Chrome molybdenum steel	Nickel plated
31	Round head Phillips screw	Stainless steel	Nickel plated
32	Hexagon socket head plug	Chrome molybdenum steel	Nickel plated
33	Linear guide	Stainless steel	
34	Hexagon socket head cap screw	Chrome molybdenum steel	Nickel plated
35	Body	Aluminum alloy	Clear hard anodized
36	Cylinder tube	Aluminum alloy	Hard anodized
37	Tube attaching bracket	Aluminum alloy	Clear hard anodized
38	Hexagon socket head cap screw	Chrome molybdenum steel	Nickel plated
39	Hexagon socket head cap screw	Chrome molybdenum steel	Nickel plated
40	Top cover	Aluminum alloy	Clear hard anodized
41	Cushion seal holder	Aluminum alloy	Chromated
42	Bumper	Urethane	CYP32 only
43	O-ring	NBR	
44	C type snap ring for shaft	Carbon tool steel	
45	O-ring	NBR	

Dimensions (mm)

1 in = 25.4mm

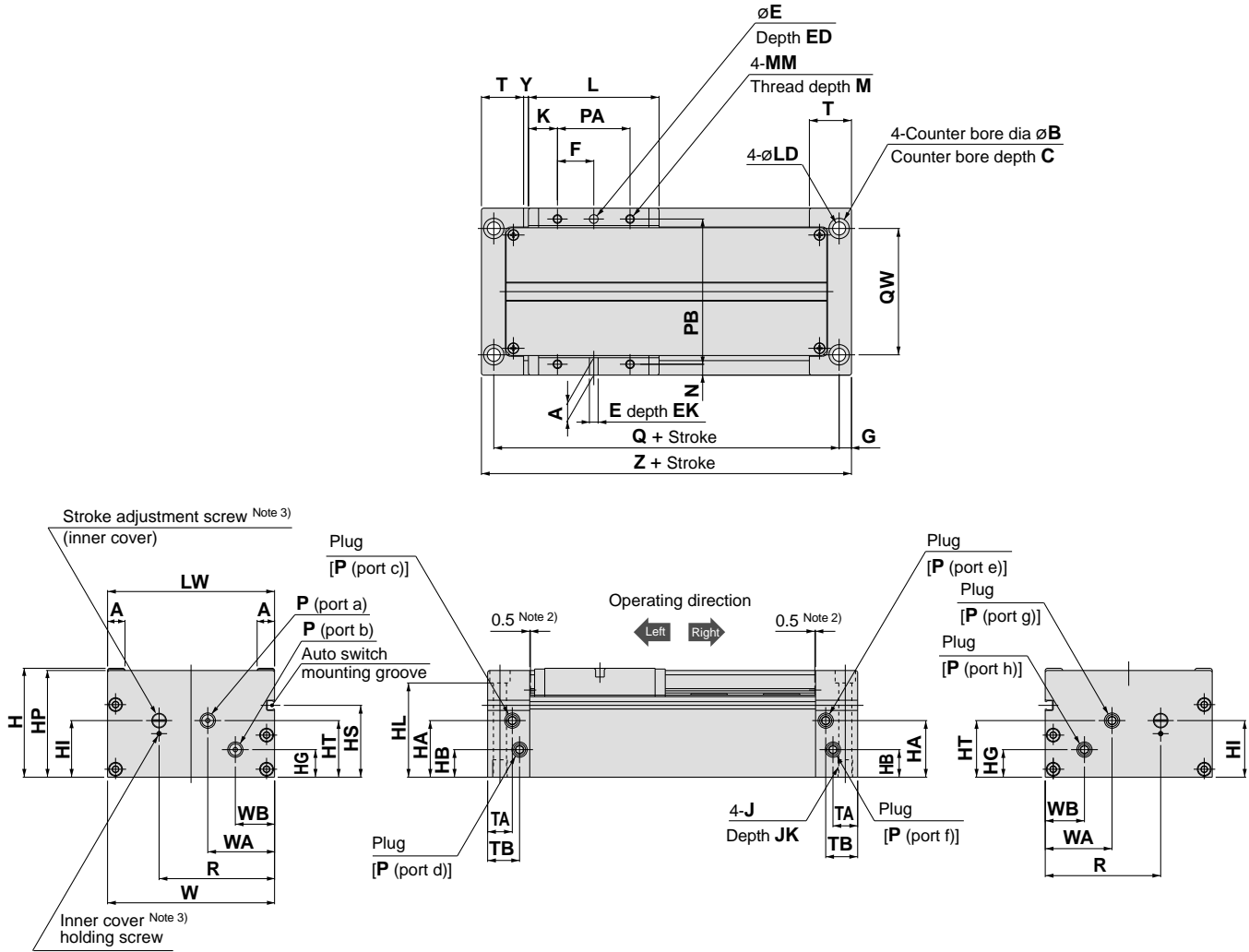

(mm)

Model	A	B	C	E	ED	EK	F	G	H	HA	HB	HG	HI	HL	HP	HS	HT	J	JK	K
CYP15	8	9.5	5.4	4H9 ^{+0.030} ₀	9.5	4	12.5	6.5	45	19.5	8.5	8.5	23	38.6	44	27	19.5	M6 x 1	10	21
CYP32	12	14	8.6	6H9 ^{+0.030} ₀	13	6	25	8.5	75	39	19	19	39	64.9	73.5	49.5	39	M10 x 1.5	12	20

Model	L	LD	LW	MM	M	N	P	PA	PB	Q	QW	R	T	TA	TB	W	WA	WB	Y	Z
CYP15	67	5.6	69	M4 x 0.7	6	4.5	M5 x 0.8	25	60	105	48	45	23	13	18	69	32	17	2.5	118
CYP32	90	8.6	115	M6 x 1	8	7.5	Rc 1/8	50	100	138	87	79.5	29	17	22	115	46	27	3.5	155

Note 1) These dimension drawings indicate the case of piping port position "Nil".

Note 2) These dimensions indicate the protruding portion of the bumper.

Note 3) Refer to "Specific Product Precautions [Cushion Effect (Sine Cushion) and Stroke Adjustment] on page 22.

Auto Switch Common Specifications

Type	Reed switch	Solid state switch
Leakage current	None	3 wire: 100μA or less, 2 wire: 0.8mA or less
Operating time	1.2ms	1ms or less
Impact resistance	300m/s ² {30.6G}	1000m/s ² {102G}
Insulation resistance	50MΩ or more at 500VDC (between lead wire and case)	
Withstand voltage	1500VAC for 1 min. (between lead wire and case)	1000VAC for 1 min. (between lead wire and case)
Ambient temperature	-10 to 60°C (14° to 140°F)	
Enclosure	IEC529 standard IP67, JISC0920 watertight construction	

Lead Wire Length

Lead wire length indication

(example)

D-Z73 L

Lead wire length

Nil	0.5m
L	3m
Z	5m

Note 1) Lead wire length Z: 5m applicable auto switch
 Reed: D-Z73
 Solid state: All types are produced upon receipt of order (standard availability).

Auto Switch Hysteresis

Hysteresis is the distance from the position at which piston movement activates an auto switch to the position at which reverse movement turns the switch OFF. This hysteresis is included in part of the operating range (one side).

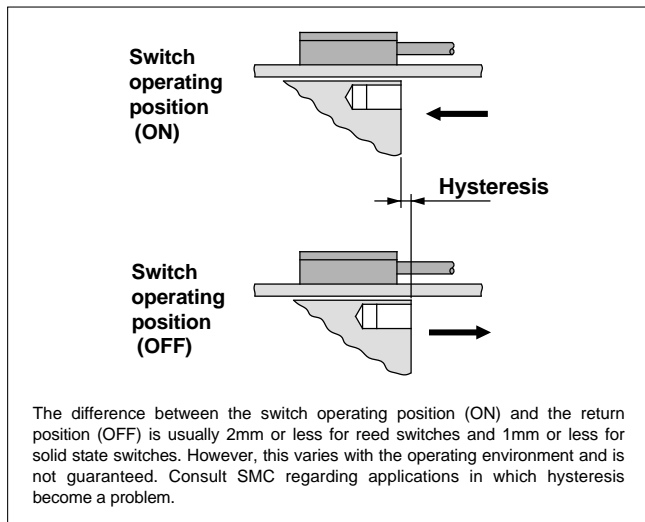

Contact Protection Boxes/CD-P11, CD-P12

D-Z7 and D-Z8 type switches do not have internal contact protection circuits.

1. The operating load is an induction load.
2. The length of wiring to the load is 5m or more.
3. The load voltage is 100VAC.

A contact protection box should be used in any of the above situations.

Contact protection box specifications

Part no.	CD-P11		CD-P12
Load voltage	100VAC or less	200VAC	24VDC
Maximum load current	25mA	12.5mA	50mA

* Lead wire length.....Switch connection side 0.5m
 Load connection side 0.5m



Contact protection box internal circuits

Lead wire colors inside () are those prior to conformity with IEC standards.

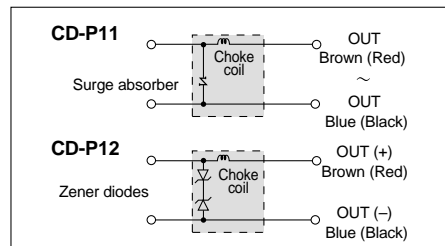

Contact protection box/Dimensions

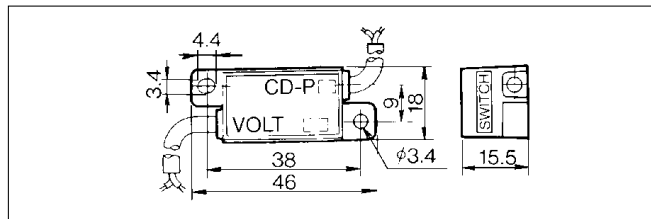

Contact Protection Box/Connection

To connect a switch unit to a contact protection box, connect the lead wire from the side of the contact protection box marked SWITCH to the lead wire coming out of the switch unit.

Furthermore, the switch unit should be kept as close as possible to the contact protection box, with a lead wire length of no more than 1 meter between them.

Basic Wiring

Solid state 3 wire, NPN

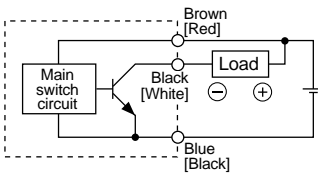

(Power supplies for switch and load are separate.)

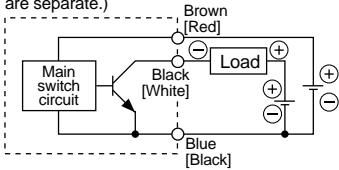

Solid state 3 wire, PNP

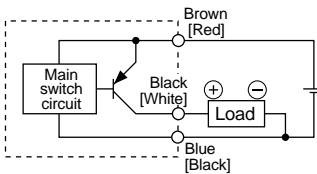

2 wire <Solid state>

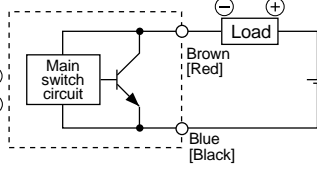

2 wire <Reed switch>

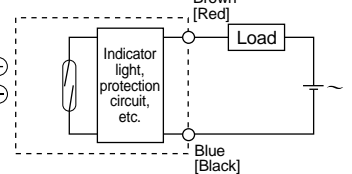

Examples of Connection to PLC

Sink input specifications

3 wire, NPN

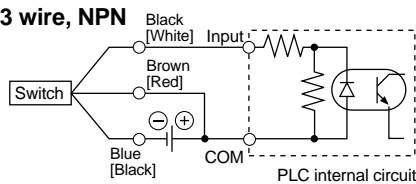

2 wire

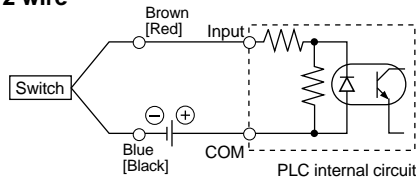

Source input specifications

3 wire, PNP

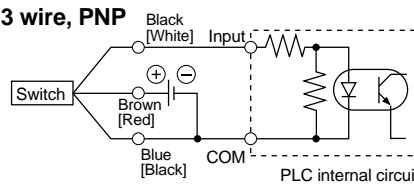

2 wire

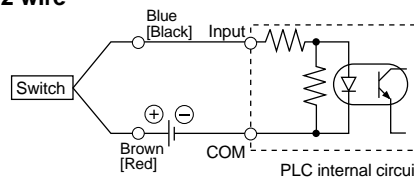

Connect according to the applicable PLC input specifications, as the connection method will vary depending on the PLC input specifications.

Connection Examples for AND (Series) and OR (Parallel)

3 wire

AND connection for NPN output (using relays)

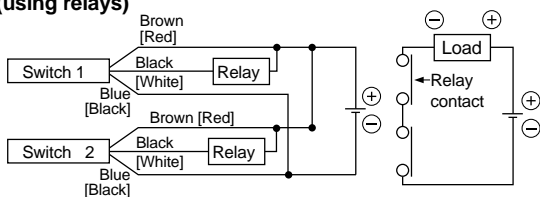

AND connection for NPN output (performed with switches only)

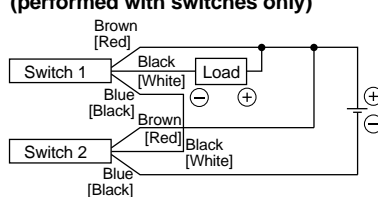

OR connection for NPN output

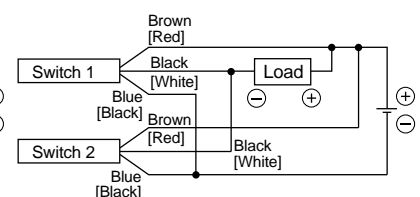

The indicator lights will light up when both switches are turned ON.

2 wire with 2 switch AND connection

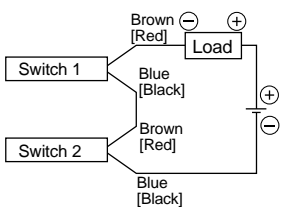

When two switches are connected in series, a load may malfunction because the load voltage will decline when in the ON state. The indicator lights will light up if both of the switches are in the ON state.

$$\begin{aligned} \text{Load voltage at ON} &= \frac{\text{Power supply voltage}}{\text{Residual voltage}} \times 2 \text{ pcs.} \\ &= 24\text{V} - 4\text{V} \times 2 \text{ pcs.} \\ &= 16\text{V} \end{aligned}$$

Example: Power supply is 24VDC
Voltage decline in switch is 4V

2 wire with 2 switch OR connection

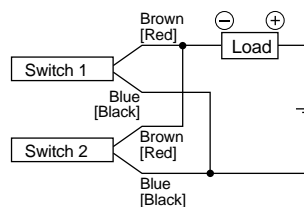

<Solid state>
When two switches are connected in parallel, malfunction may occur because the load voltage will increase when in the OFF state.

<Reed switch>
Because there is no current leakage, the load voltage will not increase when turned OFF. However, depending on the number of switches in the ON state, the indicator lights may sometimes get dim or not light up, because of dispersion and reduction of the current flowing to the switches.

$$\begin{aligned} \text{Load voltage at OFF} &= \frac{\text{Leakage current}}{\text{Load impedance}} \times 2 \text{ pcs.} \times \text{Load impedance} \\ &= 1\text{mA} \times 2 \text{ pcs.} \times 3\text{k}\Omega \\ &= 6\text{V} \end{aligned}$$

Example: Load impedance is 3kΩ
Leakage current from switch is 1mA

Auto Switches/Proper Mounting Position for Stroke End Detection

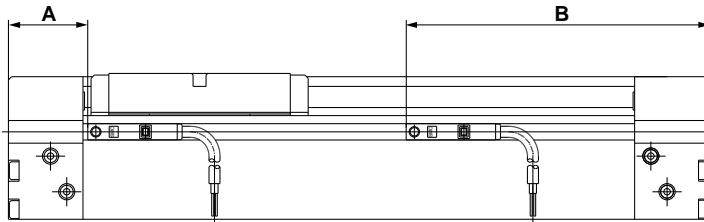

Auto Switch Operating Range

Auto switch model	Cylinder model	
	D-Z7□ D-Z80	D-Y7□W D-Y7□WV D-Y5□ D-Y6□ D-Y7P D-Y7PV
CYP15	6.5 mm	2.5 mm
CYP32	9.5 mm	3 mm

Note) Operating ranges are standards including hysteresis, and are not guaranteed. (variations on the order of ±30%)

Large variations may occur depending on the surrounding environment.

1in = 25.4mm

Proper auto switch mounting position

Auto switch model	A			B		
	D-Z7□ D-Z80	D-Y7□W D-Y7□WV	D-Y5□ D-Y6□ D-Y7P D-Y7PV	D-Z7□ D-Z80	D-Y7□W D-Y7□WV	D-Y5□ D-Y6□ D-Y7P D-Y7PV
CYP15	24.5 mm			93.5 mm		
CYP32	33 mm			122 mm		

Auto Switch Mounting

When mounting auto switches, they should be inserted into the cylinder's switch groove from the direction shown in the drawing on the right. After setting in the mounting position, use a flat head watchmakers screw driver to tighten the set screw which is included.

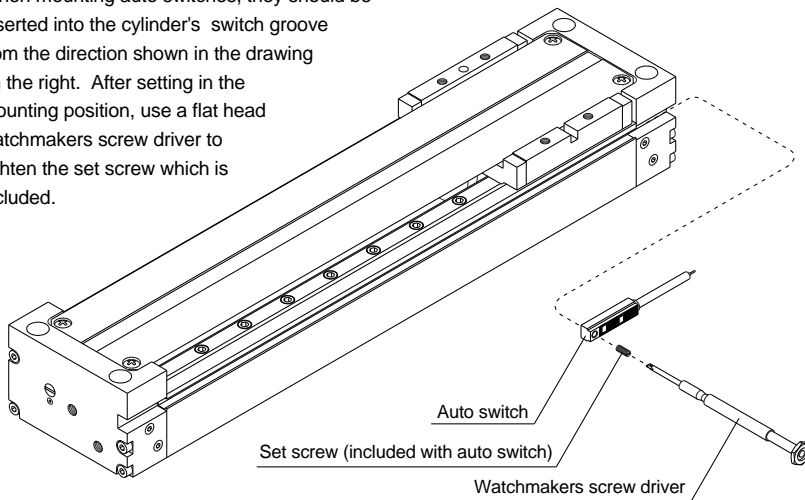

Note) When tightening the auto switch set screw (included with the auto switch), use a watchmakers screw driver with a handle about 5 to 6mm in diameter. The tightening torque should be approximately 0.05 to 0.1N·m. (0.04 to 0.07 ft·lb)

Clean Room Rodless Cylinder

Reed Switches/Direct Mount Type
D-Z73/Z76/Z80

Series CYP



Auto Switch Specifications

With indicator light

Auto switch part no.	D-Z73		D-Z76
Electrical entry direction	In-line		
Applicable loads	Relay, PLC		IC circuit
Load voltage	24VDC	100VAC	4 to 8VDC
Maximum load current or current range	5 to 40mA	5 to 20mA	20mA
Contact protection circuit	None		
Internal voltage drop	2.4V or less (to 20mA)/3V or less (to 40mA)		0.8V or less
Indicator light	Red LED lights up when ON		

Without indicator light

Auto switch part no.	D-Z80		
Electrical entry direction	In-line		
Applicable load	Relay, PLC, IC circuit		
Load voltage	24V ^{AC} _{DC} or less	48V ^{AC} _{DC}	100V ^{AC} _{DC}
Maximum load current	50mA	40mA	20mA
Contact protection circuit	None		
Internal resistance	1Ω or less (including lead wire length of 3m)		

- Lead wires — Oil resistant vinyl heavy duty cord, ø3.4, 0.2mm², 2 wire [Brown, Blue (Red, Black)], 3 wire [Brown, Black, Blue (Red, White, Black)], 0.5m (D-Z73 only ø2.7, 0.18mm², 2 wire)

Note) Refer to page 5 for auto switch common specifications and lead wire lengths.

Internal circuits

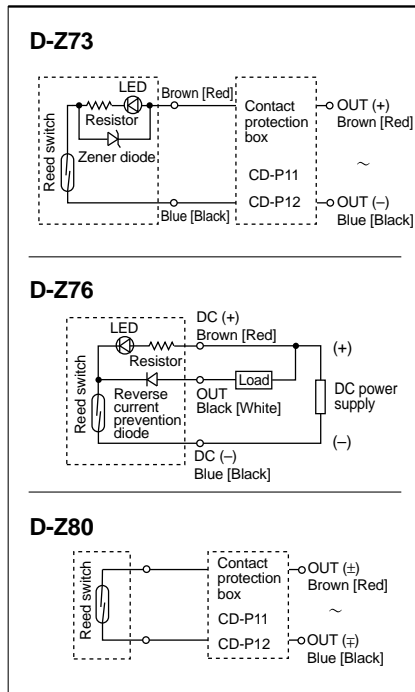

- Note) 1. The load is an induction load.
2. The lead wire length to the load is 5m or more.
3. The load voltage is 100VAC.
Use a contact protection box in any of the above situations, as the life of the contacts may otherwise be reduced. (Refer to page 5 for detailed specifications of the contact protection boxes.)

Weights

Unit: g (oz.)

Model	Lead wire length 0.5m	Lead wire length 3m
D-Z73	7 (0.25)	31 (1.09)
D-Z76	10 (0.35)	55 (1.94)
D-Z80	9 (0.32)	49 (1.73)

Dimensions (mm)

1in = 25.4mm

D-Z73

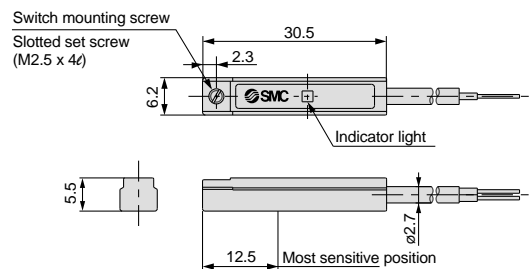

D-Z76, Z80

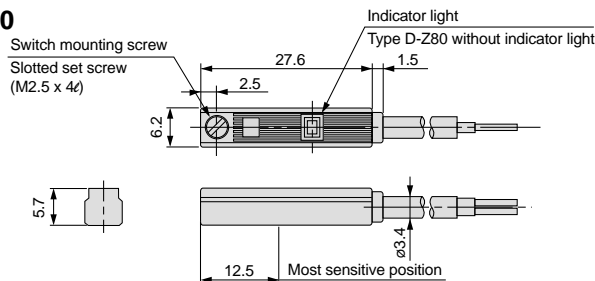

Auto Switch Specifications

D-Y5, D-Y6, D-Y7P, D-Y7PV (with indicator light)

Auto switch part no.	D-Y59A	D-Y69A	D-Y7P	D-Y7PV	D-Y59B	D-Y69B
Electrical entry direction	In-line	Perpendicular	In-line	Perpendicular	In-line	Perpendicular
Wiring type	3 wire			2 wire		
Output type	NPN		PNP		-	
Applicable loads	IC circuit, Relay, PLC				24VDC Relay, PLC	
Power supply voltage	5, 12, 24VDC (4.5 to 28VDC)				-	
Current consumption	10mA or less				-	
Load voltage	28VDC or less		-		24VDC (10 to 28VDC)	
Load current	40mA or less		80mA or less		5 to 40mA	
Internal voltage drop	1.5V or less (0.8V or less at 10mA load current)		0.8V or less		4V or less	
Leakage current	100μA or less at 24VDC				0.8mA or less at 24VDC	
Indicator light	Red LED lights up when ON					

● Lead wires—Oil resistant, flexible vinyl heavy duty cord,
 ø3.4, 0.15mm², 3 wire [Brown, Black, Blue (Red, White, Black)], 2 wire [Brown, Blue (Red, Black)], 0.5m
 Note) Refer to page 5 for auto switch common specifications and lead wire lengths.



Weights

Unit: g (oz)

Model	Lead wire length	
	0.5m	3m
D-Y59A, Y69A, Y7P	10 (0.35)	53 (1.87)
D-Y59B, Y69B, Y7PV	9 (0.32)	50 (1.77)

Internal circuits

D-Y59A, Y69A

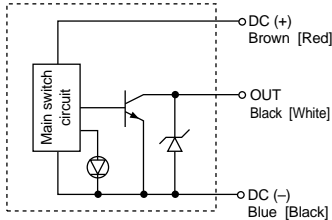

D-Y7P (V)

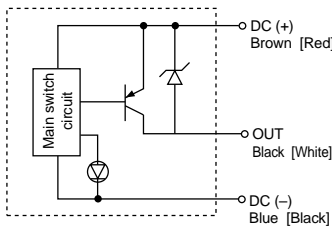

D-Y59B, Y69B

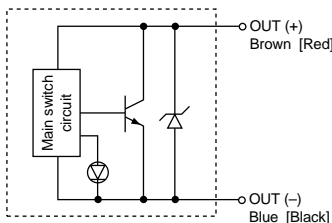

Dimensions

1in = 25.4mm

D-Y59A, Y59B D-Y7P

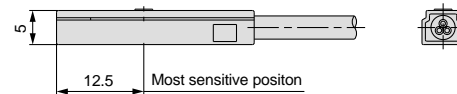
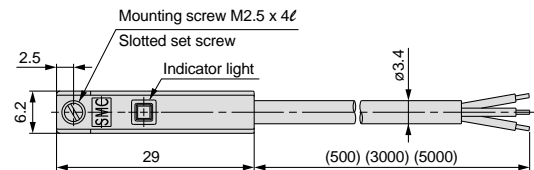

D-Y69A, Y69B D-Y7PV

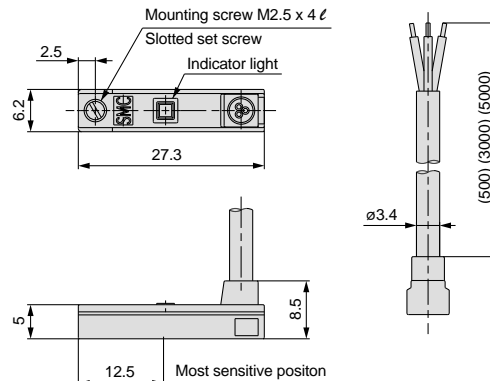

Clean Room Rodless Cylinder

2 Color Indication Solid State Switches / Direct Mount Type

D-Y7NW (V)/Y7PW (V)/D-Y7BW (V)

Series CYP



Auto Switch Specifications

D-Y7□W, D-Y7□WV (with indicator light)

Auto switch part no.	D-Y7NW	D-Y7NWV	D-Y7PW	D-Y7PWV	D-Y7BW	D-Y7BWV
Electrical entry direction	In-line	Perpendicular	In-line	Perpendicular	In-line	Perpendicular
Wiring type	3 wire			2 wire		
Output type	NPN		PNP		-	
Applicable loads	IC circuit, Relay, PLC				24VDC Relay, PLC	
Power supply voltage	5, 12, 24VDC (4.5 to 28VDC)					-
Current consumption	10mA or less					-
Load voltage	28VDC or less		-		24VDC (10 to 28VDC)	
Load current	40mA or less		80mA or less		2.5 to 40mA	
Internal voltage drop	1.5V or less (0.8V or less at 10mA load current)		0.8V or less		4V or less	
Leakage current	100μA or less at 24VDC				0.8mA or less at 24VDC	
Indicator light	Operating position Red LED lights up Optimum operating position Green LED lights up					

- Lead wires — Oil resistant, flexible vinyl heavy duty cord, $\phi 3.4$, 0.15mm², 3 wire [Brown, Black, Blue (Red, White, Black)], 2 wire [Brown, Blue (Red, Black)], 0.5m (Note) Refer to page 5 for auto switch common specifications and lead wire lengths.

Internal circuits

D-Y7NW(V)/3 wire NPN output

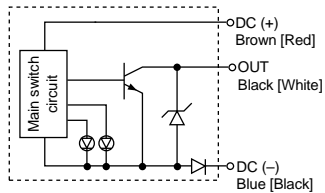

D-Y7PW(V)/3 wire PNP output

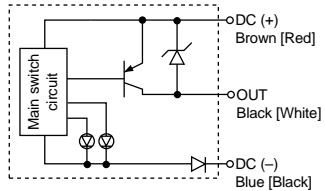

D-Y7BW(V)/2 wire

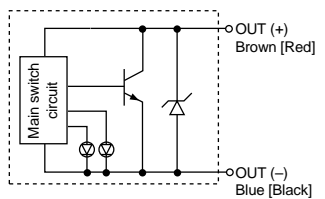

Indicator light/Display method

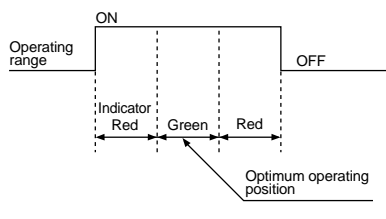

Weights

Model	Lead wire length	
	0.5m	3m
D-Y7N, Y7P	10 (0.35)	53 (1.87)
D-Y7B	9 (0.32)	50 (1.77)

Unit: g (oz)

Dimensions (mm)

1 in = 25.4mm

D-Y7□W

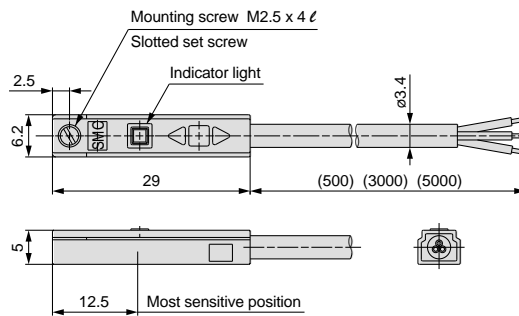

D-Y7□WV

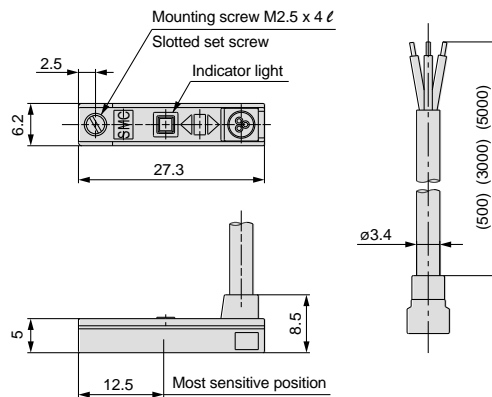

Design Precautions (1)

The load mass allowable moment differs depending on the work piece mounting method, cylinder mounting orientation and piston speed. In making a determination of usability, do not allow the sum ($\Sigma\alpha_n$) of the load factors (α_n) for each mass and moment to exceed "1".

$$\Sigma\alpha_n = \frac{\text{Load mass (m)}}{\text{Max. load mass (m max)}} + \frac{\text{Static moment (M)}}{\text{Allowable static moment (M max)}} + \frac{\text{Dynamic moment (Me)}}{\text{Allowable dynamic moment (Me max)}} \leq 1$$

Load mass

Max. load mass (kg)

Model	m max
CYP15	1
CYP32	5

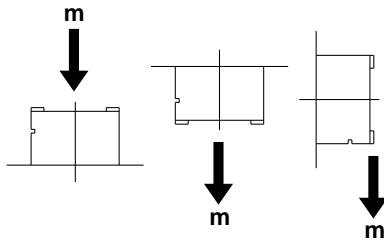

Moment

Allowable moment

(Static moment/Dynamic moment)

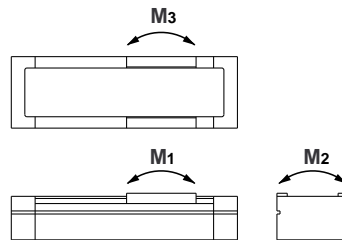

Model	(N·m)		
	M1	M2	M3
CYP15	0.3	0.6	0.3
CYP32	3	4	3

Static moment

Moment generated by the work piece weight even when the cylinder is stopped

■ Pitch moment

$$M_1 = m \times g \times (L + B) \times 10^{-3}$$

■ Roll moment

$$M_2 = m \times g \times (L + B) \times 10^{-3}$$

■ Yaw moment

$$M_3 = m \times g \times (L + A) \times 10^{-3}$$

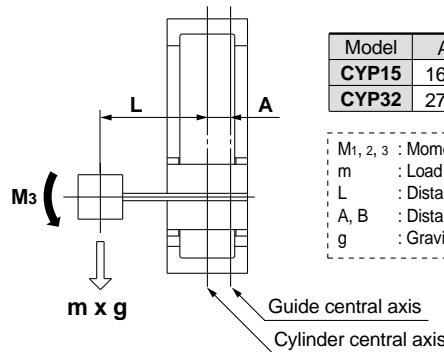
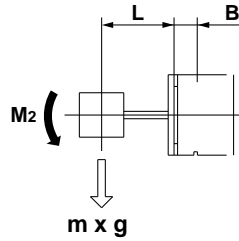
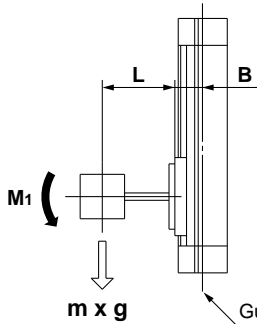

Model	(mm)	
	A	B
CYP15	16.5	25.5
CYP32	27.0	48.0

M_{1, 2, 3} : Moment [N·m]
 m : Load mass [kg]
 L : Distance to load center of gravity [mm]
 A, B : Distance to guide shaft [mm]
 g : Gravitational acceleration [9.8m/s²]

Dynamic moment

Moment generated by the load equivalent to impact at the stroke end

$$We = 5 \times 10^{-3} \times m \times g \times U$$

We: Load equivalent to impact [N] U: Max. speed [mm/s]
 m : Load mass [kg] g: Gravitational acceleration [9.8m/s²]

■ Pitch moment

$$Me_1 = *1/3 \cdot We (L + B) \cdot 10^{-3}$$

* Average load coefficient

■ Yaw moment

$$Me_3 = *1/3 \cdot We (L + A) \cdot 10^{-3}$$

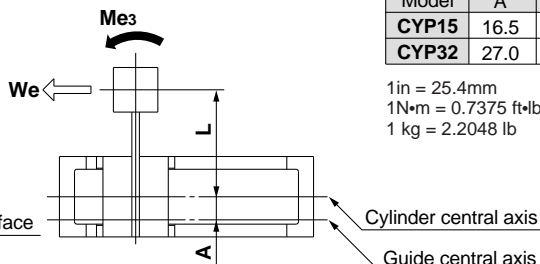
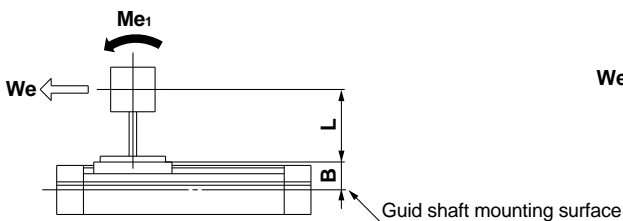

Model	(mm)	
	A	B
CYP15	16.5	25.5
CYP32	27.0	48.0

1in = 25.4mm
 1N·m = 0.7375 ft·lb
 1 kg = 2.2048 lb

Selection Calculation

The selection calculation finds the load factors (α_n) of the items below, where the total ($\sum \alpha_n$) does not exceed 1.

$$\sum \alpha_n = \alpha_1 + \alpha_2 + \alpha_3 \leq 1$$

Item	Load factor α_n	Note
1. Max. load mass	$\alpha_1 = m/m_{max}$	Review m m_{max} is the maximum load mass
2. Static moment	$\alpha_2 = M/M_{max}$	Review M_1, M_2, M_3 M_{max} is the allowable moment
3. Dynamic moment	$\alpha_3 = Me/Me_{max}$	Review Me_1, Me_3 Me_{max} is the allowable moment

Calculation example

Operating conditions

Cylinder: CYP32
 Mounting: Horizontal wall mounting
 Maximum speed: $U = 300$ [mm/s]
 Load mass: $m = 1$ [kg] (excluding mass of arm section)
 $L_1 = 50$ [mm]
 $L_2 = 50$ [mm]

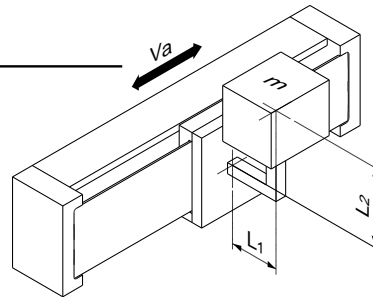

Item	Load factor α_n	Note
1. Maximum load mass 	$\alpha_1 = m/m_{max}$ $= 1/5$ $= \mathbf{0.20}$	Review m.
2. Static moment 	$M_2 = m \cdot g \cdot (L_1 + B) \cdot 10^{-3}$ $= 1 \cdot 9.8 \cdot (50 + 48) \cdot 10^{-3}$ $= 0.96$ [N·m] $\alpha_2 = M_2/M_2 \text{ max}$ $= 0.96/4$ $= \mathbf{0.24}$	Review M_2 . Since M_1 & M_3 are not generated, review is unnecessary.
3. Dynamic moment 	$We = 5 \times 10^{-3} \cdot m \cdot g \cdot U$ $= 5 \times 10^{-3} \cdot 1 \cdot 9.8 \cdot 300$ $= 14.7$ [N] $Me_3 = 1/3 \cdot We \cdot (L_2 + A) \cdot 10^{-3}$ $= 1/3 \cdot 14.7 \cdot (50 + 27) \cdot 10^{-3}$ $= 0.38$ [N·m] $\alpha_3 = Me_3/Me_3 \text{ max}$ $= 0.38/3$ $= \mathbf{0.13}$	Review Me_3 .
	$Me_1 = 1/3 \cdot We \cdot (L_1 + B) \cdot 10^{-3}$ $= 1/3 \cdot 14.7 \cdot (50 + 48) \cdot 10^{-3}$ $= 0.48$ [N·m] $\alpha_4 = Me_1/Me_1 \text{ max}$ $= 0.48/3$ $= \mathbf{0.16}$	Review Me_1 .

$$\begin{aligned} \sum \alpha_n &= \alpha_1 + \alpha_2 + \alpha_3 + \alpha_4 \\ &= 0.20 + 0.24 + 0.13 + 0.16 \\ &= 0.73 \\ \sum \alpha_n &= 0.73 \leq 1 \text{ Therefore it can be used.} \end{aligned}$$

Precautions on Design (2)

Table Deflection (Note)

Displacement of table due to pitch moment load

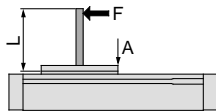

$$M_1 = F \times L$$

Displacement of table due to roll moment load

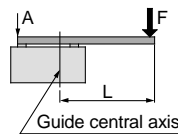

$$M_2 = F \times L$$

Displacement of table due to yaw moment load

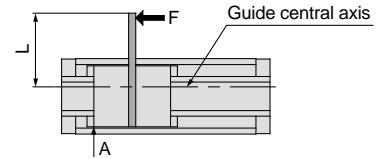

$$M_3 = F \times L$$

Note) Displacement of Section A when force acts on Section F

CYP15 (M₁)

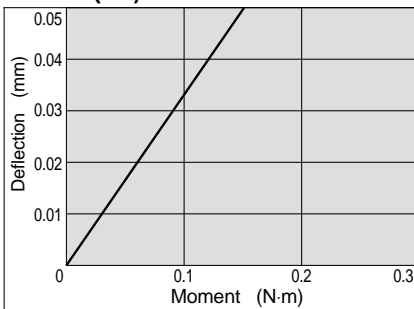

CYP15 (M₂)

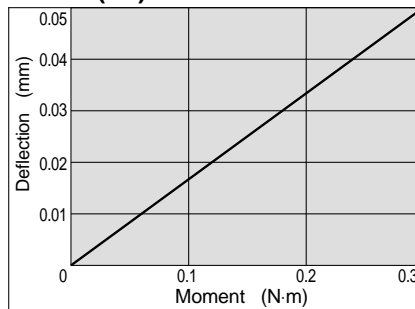

CYP15 (M₃)

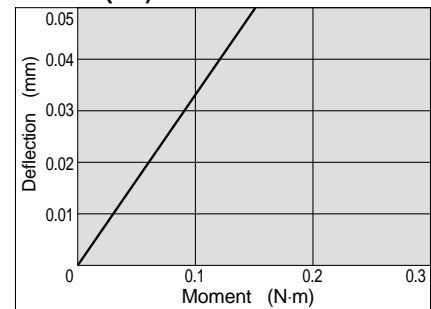

CYP32 (M₁)

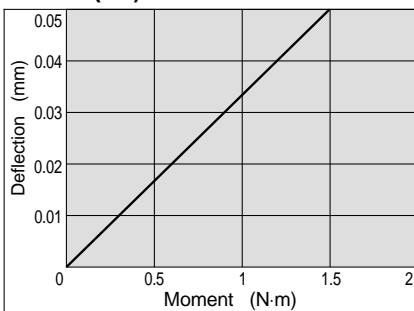

CYP32 (M₂)

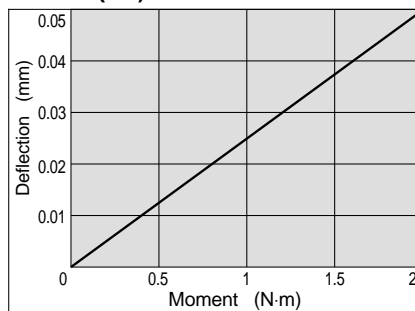

CYP32 (M₃)

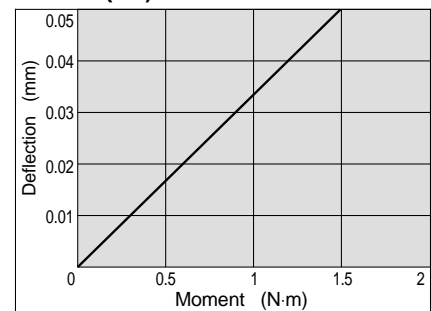

Vertical Operation

When using in vertical operation, prevention of work piece dropping due to breaking of the magnetic coupling should be considered. The allowable load mass and maximum operating pressure should be as shown in the table below.

Model	Allowable load mass mv (kg)	Maximum operating pressure Pv (MPa)
CYP15	1	0.3
CYP32	5	

1MPa = 145 psi
 1 kg = 2.2046 lb
 1N·m = 0.7375 ft·lb
 1in = 25.4mm

Intermediate Stops

The cushion effect (smooth start-up, soft stop) exists only before the stroke end in the stroke ranges indicated in the table below.

The cushion effect (smooth start-up, soft stop) cannot be obtained in an intermediate stop or return from an intermediate stop using an external stopper, etc.

When using an intermediate stop considering the above information, implement measures to prevent particulate generation and set the operating pressure to no more than 0.3MPa.

Cushion stroke

Model	Stroke (mm)
CYP15	25
CYP32	30

These safety instructions are intended to prevent a hazardous situation and/or equipment damage. These instructions indicate the level of potential hazard by a label of "**Caution**", "**Warning**" or "**Danger**". To ensure safety, be sure to observe ISO 4414 Note 1), JIS B 8370 Note 2) and other safety practices.

 **Caution** : Operator error could result in injury or equipment damage.

 **Warning** : Operator error could result in serious injury or loss of life.

 **Danger** : In extreme conditions, there is a possible result of serious injury or loss of life.

Note 1) ISO 4414: Pneumatic fluid power – Recommendations for the application of equipment to transmission and control systems

Note 2) JIS B 8370: General Rules for Pneumatic Equipment

Warning

1. The compatibility of pneumatic equipment is the responsibility of the person who designs the pneumatic system or decides its specifications.

Since the products specified here are used in various operating conditions, their compatibility for the specific pneumatic system must be based on specifications or after analysis and/or tests to meet your specific requirements.

2. Only trained personnel should operate pneumatically operated machinery and equipment.

Compressed air can be dangerous if handled incorrectly. Assembly, handling or repair of pneumatic systems should be performed by trained and experienced operators.

3. Do not service machinery/equipment or attempt to remove components until safety is confirmed.

1. Inspection and maintenance of machinery/equipment should only be performed after confirmation of safe locked-out control positions.
2. When equipment is to be removed, confirm the safety process as mentioned above. Cut the supply pressure for this equipment and exhaust all residual compressed air in the system.
3. Before machinery/equipment is restarted, take measures to prevent shooting-out of cylinder piston rod, etc. (Bleed air into the system gradually to create back pressure.)

4. Contact SMC if the product is to be used in any of the following conditions:

1. Conditions and environments beyond the given specifications, or if product is used outdoors.
2. Installation on equipment in conjunction with atomic energy, railway, air navigation, vehicles, medical equipment, food and beverages, recreation equipment, emergency stop circuits, press applications, or safety equipment.
3. An application which has the possibility of having negative effects on people, property, or animals, requiring special safety analysis.

Precautions on Design

 **Warning****1. There is a danger of sudden action by air cylinders if sliding parts of machinery are twisted, etc., and, changes in forces occur.**

In such cases, human injury may occur; e.g., by catching hands or feet in the machinery, or damage to the machinery itself may occur. Therefore, the machine should be designed to avoid such dangers.

2. Install a protective cover when there is a risk of human injury.

If a driven object and moving parts of a cylinder pose a danger of human injury, design the structure to avoid contact with the human body.

3. Securely tighten all stationary parts and connected parts so that they will not become loose.

Especially when a cylinder operates with high frequency or is installed where there is a lot of vibration, ensure that all parts remain secure.

4. A deceleration circuit may be required.

When a driven object is operated at high speed or the load is heavy, a cylinder's cushion will not be sufficient to absorb the impact. Install a deceleration circuit to reduce the speed before cushioning to relieve the impact. In this case, the rigidity of the machinery should also be examined.

5. Consider a possible drop in operating pressure due to a power outage, etc.

When a cylinder is used in a clamping mechanism, there is a danger of work pieces dropping if there is a decrease in clamping force due to a drop in circuit pressure caused by a power outage, etc. Therefore, safety equipment should be installed to prevent damage to machinery and/or human injury. Suspension mechanisms and lifting devices also require consideration for drop prevention.

6. Consider a possible loss of power source.

Measures should be taken to protect against human injury and equipment damage in the event that there is a loss of power to equipment controlled by air pressure, electricity or hydraulics, etc.

7. Design circuitry to prevent sudden lurching of driven objects.

When a cylinder is driven by an exhaust center type directional control valve or when starting up after residual pressure is exhausted from the circuit, etc., the piston and its driven object will lurch at high speed if pressure is applied to one side of the cylinder because of the absence of air pressure inside the cylinder. Therefore, equipment should be selected and circuits designed to prevent sudden lurching because, there is a danger of human injury and/or damage to equipment when this occurs.

8. Consider emergency stops.

Design so that human injury and/or damage to machinery and equipment will not be caused when machinery is stopped by a safety device under abnormal conditions, a power outage or a manual emergency stop.

9. Consider the action when operation is restarted after an emergency stop or abnormal stop.

Design the machinery so that human injury or equipment damage will not occur upon restart of operation. When the cylinder has to be reset at the starting position, install safe manual control equipment.

Selection

 **Warning****1. Confirm the specifications.**

The products advertised in this catalog are designed according to use in industrial compressed air systems. If the products are used in conditions where pressure, temperature, etc., are out of specification, damage and/or malfunction may be caused. Do not use in these conditions. (Refer to specifications.)

Consult SMC if you use a fluid other than compressed air.

2. Intermediate stops

When intermediate stopping of a cylinder piston is performed with a 3 position closed center type directional control valve, it is difficult to achieve stopping positions as accurate and minute as with hydraulic pressure due to the compressibility of air.

Furthermore, since zero air leakages is not guaranteed, it may not be possible to hold a stopped position for an extended period of time. Contact SMC in case it is necessary to hold a stopped position for an extended period.

 **Caution****1. Operate within the limits of the maximum usable stroke.**

Refer to the standard strokes for the maximum useable stroke.

2. Use a speed controller to adjust the cylinder drive speed, gradually increasing from a low speed to the desired speed setting.

Mounting

Caution

1. Align carefully when connecting to a load having an external guide mechanism.

Since alignment variations increase as the stroke becomes longer, a connection method (floating mechanism) should be considered which can absorb these variations.

2. When an external guide is used, connect the external slider and the load in such a way that there is no interference at any point within the stroke.

3. Do not scratch or gouge the sliding parts of the cylinder tube by striking or grasping them with other objects.

Cylinder bores are manufactured to precise tolerances, so that even a slight deformation may cause malfunction.

4. Do not use until you verify that the equipment can operate properly.

After mounting, repair or modification, etc., connect the air supply and electric power, and then confirm proper mounting by means of appropriate function and leak tests.

5. Instruction manual

Mount and operate the product after thoroughly reading the manual and understanding its contents.

Keep the instruction manual where it can be referred to as needed.

Piping

Caution

1. Preparation before piping

Before piping is connected, it should be thoroughly blown out with air (flushing) or washed to remove chips, cutting oil and other debris from inside the pipe.

Air Supply

Warning

1. Use clean air.

Do not use compressed air including chemicals, synthetic oils containing organic solvents, salt or corrosive gases, etc., as it can cause damage or malfunction.

Caution

1. Install air filters.

Install air filters at the upstream side of valves. The filtration degree should be 5µm or finer.

2. Install an after cooler, air dryer or Drain Catch, etc.

Air that includes excessive drainage may cause malfunction of valves and other pneumatic equipment. To prevent this, install an after cooler, air dryer or Drain Catch, etc.

3. Use the product within the specified range of fluid and ambient temperature.

Take measures to prevent freezing, since moisture in circuits will be frozen under 5°C, and this can cause damage to seals and malfunction.

Refer to SMC's clean pneumatic series "Air Cleaning Equipment" catalog for further details on compressed air quality.

Operating Environment

Warning

1. Do not use in environments where there is a danger of corrosion.

Refer to the construction drawings regarding cylinder materials.

Maintenance

Warning

1. Perform maintenance according to the procedure indicated in the instruction manual.

Improper handling can cause malfunction and damage of machinery or equipment.

2. Removal of equipment and supply/exhaust of compressed air.

When machinery is serviced, first check measures to prevent dropping of driven objects and run-away of equipment, etc. Then cut off the supply pressure and electric power, and exhaust all compressed air from the system.

When machinery is restarted, proceed with caution after confirming measures to prevent lurching of actuators.

Caution

1. Drain flushing.

Remove drainage from air filters regularly. (Refer to specifications.)

Design & Selection

⚠ Warning

1. Confirm the specifications.

Read the specifications carefully and use this product appropriately. The product may be damaged or malfunction if it is used outside the range of specifications of current load, voltage, temperature or impact.

2. Take precautions when multiple cylinders are used close together.

When multiple auto switch cylinders are used in close proximity, magnetic field interference may cause the switches to malfunction. Maintain a minimum cylinder separation of 40mm. (When the allowable separation is indicated for each cylinder series, use the specified value.)

3. Pay attention to the length of time that a switch is ON at an intermediate stroke position.

When an auto switch is placed at an intermediate position of the stroke and a load is driven at the time the piston passes, the auto switch will operate, but if the speed is too great the operating time will be shortened and the load may not operate properly. The maximum detectable piston speed is:

$$V(\text{mm/s}) = \frac{\text{Auto switch operating range (mm)}}{\text{Time load applied (ms)}} \times 1000$$

4. Keep wiring as short as possible.

<Reed switch>

As the length of the wiring to a load gets longer, the rush current at switching ON becomes greater, and this may shorten the product's life. (The switch will stay ON all the time.)

- 1) Use a contact protection box when the wire length is 5m or longer.

<Solid state switch>

- 2) Although wire length should not affect switch function, use wiring 100m or shorter.

5. Take precautions for the internal voltage drop of the switch.

<Reed switch>

- 1) Switches with an indicator light (Except D-Z76)
 - If auto switches are connected in series as shown below, take note that there will be a large voltage drop because of internal resistance in the light emitting diodes. (Refer to internal voltage drop in the auto switch specifications.)

[The voltage drop will be "n" times larger when "n" auto switches are connected.]

Even though an auto switch operates normally, the load may not operate.

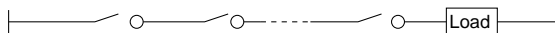

⚠ Warning

- In the same way, when operating at or below a specified voltage, although an auto switch may operate normally, the load may not operate. Therefore, the formula below should be satisfied after confirming the minimum operating voltage of the load.

$$\text{Supply voltage} - \text{Internal voltage drop of switch} > \text{Minimum operating voltage of load}$$

- 2) If the internal resistance of a light emitting diode causes a problem, select a switch without an indicator light (Model D-Z80).

<Solid state switch>

- 3) Generally, the internal voltage drop will be greater with a 2 wire solid state auto switch than with a reed switch. Take the same precautions as in 1).

Also, note that a 12VDC relay is not applicable.

6. Pay attention to leakage current.

<Solid state switch>

With a 2 wire solid state auto switch, current (leakage current)

$$\text{Operating current of load (OFF condition)} > \text{Leakage current}$$

flows to the load to operate the internal circuit even when in the OFF state.

If the criteria given in the above formula are not met, it will not reset correctly (stays ON). Use a 3 wire switch if this specification will not be satisfied.

Moreover, leakage current flow to the load will be "n" times larger when "n" auto switches are connected in parallel.

7. Do not use a load that generates surge voltage.

<Reed switch>

If driving a load such as a relay that generates a surge voltage, use a contact protection box.

<Solid state switch>

Although a zener diode for surge protection is connected at the output side of a solid state auto switch, damage may still occur if the surge is applied repeatedly. When a load, such as a relay or solenoid valve, which generates surge is directly driven, use a type of switch with a built-in surge absorbing element.

8. Cautions for use in an interlock circuit

When an auto switch is used for an interlock signal requiring high reliability, devise a double interlock system to avoid trouble by providing a mechanical protection function, or by also using another switch (sensor) together with the auto switch. Also perform periodic maintenance and confirm proper operation.

9. Ensure sufficient clearance for maintenance activities.

When designing an application, be sure to allow sufficient clearance for maintenance and inspections.

Mounting & Adjustment

Warning

1. Do not drop or bump.

Do not drop, bump or apply excessive impacts (300m/s² or more for reed switches and 1000m/s² or more for solid state switches) while handling. Although the body of the switch may not be damaged, the inside of the switch could be damaged and cause a malfunction.

2. Do not carry a cylinder by the auto switch lead wires.

Never carry a cylinder by its lead wires. This may not only cause broken lead wires, but it may cause internal elements of the switch to be damaged by the stress.

3. Mount switches using the proper tightening torque.

When a switch is tightened beyond the range of tightening torque, the mounting screws, mounting bracket or switch may be damaged. On the other hand, tightening below the range of tightening torque may allow the switch to slip out of position. (Refer to switch mounting for each series regarding switch mounting, moving, and tightening torque, etc.)

4. Mount a switch at the center of the operating range.

Adjust the mounting position of an auto switch so that the piston stops at the center of the operating range (the range in which a switch is ON). (The mounting positions shown in the catalog indicate the optimum positions at stroke end.) If mounted at the end of the operating range (around the borderline of ON and OFF), operation may be unstable.

Wiring

Warning

1. Avoid repeated application of bending or stretching force to lead wires.

Broken lead wires will result from repeatedly applying bending stress or stretching force to the lead wires.

2. Be sure to connect the load before power is applied.

<2 wire type>

If the power is turned ON when an auto switch is not connected to a load, the switch will be instantly damaged because of excess current.

3. Confirm proper insulation of wiring.

Be certain that there is no faulty wiring insulation (contact with other circuits, ground fault, improper insulation between terminals, etc.). Damage may occur due to excess current flow into a switch.

4. Do not wire with power lines or high voltage lines.

Wire separately from power lines or high voltage lines, avoiding parallel wiring or wiring in the same conduit with these lines. Control circuits containing auto switches may malfunction due to noise from these other lines.

Wiring

Warning

5. Do not allow short circuit of loads.

<Reed switch>

If the power is turned ON with a load in a short circuit condition, the switch will be instantly damaged because of excess current flow into the switch.

<Solid state switch>

All models of PNP output type switches do not have built-in short circuit protection circuits. If loads are short circuited, the switches will be instantly damaged, as in the case of reed switches.

- * Take special care to avoid reverse wiring with the brown (red) power supply line and the black (white) output line on 3 wire type switches.

6. Avoid incorrect wiring.

<Reed switch>

- * A 24VDC switch with indicator light has polarity. The brown (red) lead wire is (+), and the blue (black) lead wire is (-).

<Solid state switch>

- 1) If connections are reversed on a 2 wire type switch, the switch will not be damaged if protected by a protection circuit, but the switch will be in a normally ON state. However, note that the switch will be damaged if reversed connections are made while the load is in a short circuited condition.
- * 2) If connections are reversed (power supply line + and power supply line -) on a 3 wire type switch, the switch will be protected by a protection circuit. However, if the power supply line (+) is connected to the blue (black) wire and the power supply line (-) is connected to the black (white) wire, the switch will be damaged.

7. Perform work on terminals before bringing them into a clean room.

Some lead wires contain white powder to prevent fusion of the sheath (covering) and core wire. In cases where this powder will be a problem, perform cutting of lead wires, etc., before bringing switches into a clean room. After removing powder which has adhered to the insulating material, take steps to prevent dust from escaping, such as wrapping the area near the cut in the sheath with insulation tape, etc.

Operating Environment

Warning

1. Never use in an atmosphere of explosive gases.

The construction of auto switches is not intended to prevent explosion. Never use in an atmosphere with an explosive gas since this may cause a serious explosion.

2. Do not use in an area where a magnetic field is generated.

Auto switches will malfunction or magnets inside cylinders will become demagnetized.

3. Do not use in an environment with temperature cycles.

Consult SMC if switches are used where there are temperature cycles other than normal temperature changes, as they may be adversely affected internally.

4. Do not use in an environment where there is excessive impact shock.

<Reed switch>

When excessive impact (300m/s² or more) is applied to a reed switch during operation, the contact will malfunction and generate or cut off a signal momentarily (1ms or less). Consult SMC regarding the need to use a solid state switch depending upon the environment.

5. Do not use in an area where surges are generated.

<Solid state switch>

When there are units (solenoid type lifter, high frequency induction furnace, motor, etc.) which generate a large amount of surge in the area around cylinders with solid state auto switches, this may cause deterioration or damage to internal circuit elements of the switches. Avoid sources of surge generation and disorganized lines.

6. Avoid accumulation of iron debris or close contact with magnetic substances.

Note that if a magnetic substance (something attracted by a magnet) is brought into close proximity with an auto switch cylinder, it may cause auto switches to malfunction due to a loss of the magnetic force inside the cylinder.

Maintenance

Warning

1. Perform the following maintenance periodically in order to prevent possible danger due to unexpected auto switch malfunction.

1) Securely tighten switch mounting screws.
If screws become loose or the mounting position is dislocated, retighten them after readjusting the mounting position.

2) Confirm that there is no damage to lead wires.
To prevent faulty insulation, replace switches or repair lead wires, etc., if damage is discovered.

3) Confirm the lighting of the green light on a 2 color indication switch.

Confirm that the green LED is on when stopped at the established position. If the red LED is on, the mounting position is not appropriate. Readjust the mounting position until the green LED lights up.

Other

Warning

1. Consult SMC concerning elasticity of lead wires and usage at welding sites, etc.

*** Lead wire color changes**

Lead wire colors of SMC switches have been changed as shown below in order to meet NECA Standard 0402 for production beginning September, 1996 and thereafter. Special care should be taken regarding wire polarity during the time that the old colors still coexist with the new colors.

2 wire			3 wire		
	Old	New		Old	New
Output (+)	Red	Brown	Power supply	Red	Brown
Output (-)	Black	Blue	GND	Black	Blue
			Output	White	Black

Handling

⚠ Caution

1. Open the inner package of the double packaged clean series inside a clean room or other clean environment.
2. Perform parts replacement and disassembly work in a clean room after exhausting compressed air in the piping outside the clean room.

Mounting

⚠ Caution

1. Take care to avoid striking the cylinder tube with other objects or handling it in a way that could cause deformation.

The cylinder tube and slider units have a non-contact construction. For this reason, even a slight deformation or slippage of position can cause malfunction and loss of durability, as well as a danger of degrading the particulate generation characteristics.

2. Do not scratch or gouge the linear guide by striking it with other objects.

Since the linear guide is specially treated for maximum suppression of particulate generation due to sliding, even a slight scratch can cause malfunction and loss of durability, as well as a danger of degrading the particulate generation characteristics.

3. Since the slide table is supported by precision bearings, do not apply strong impacts or excessive moment when mounting work pieces.

4. Be sure to operate the cylinder with the plates on both sides secured.

Avoid applications in which the slide table or only one plate is secured.

5. When changing the ports to be used, be sure that unused ports are securely sealed.

Take sufficient care in sealing unused ports, because if ports are not properly sealed air can leak from the ports and particulate generation characteristics can be degraded.

Operation

⚠ Caution

1. The maximum operating pressure for the clean rodless cylinder is 0.3MPa

If the maximum operating pressure of 0.3MPa for the clean rodless cylinder is exceeded, the magnetic coupling can be broken, causing a danger of malfunction or degradation of particulate generation characteristics, etc.

2. The product can be used with a direct load applied within the allowable range, but careful alignment is necessary when connecting to a load having an external guide mechanism.

Since alignment variations increase as the stroke gets longer, use a connection method which can absorb these variations and consider measures to control particulate generation.

Operation

⚠ Caution

3. When used for vertical operation, use caution regarding possible dropping due to separation of the magnetic coupling.

When used for vertical operation, use caution as there is a possibility of dropping due to separation of the magnetic coupling if a load (pressure) greater than the allowable value is applied.

4. Do not operate with the magnetic coupling out of position.

If the magnetic coupling is out of position, push the external slider by hand (or the piston slider with air pressure) back to the proper position at the stroke end.

5. Do not supply lubrication, as this is a non-lube product.

The interior of the cylinder is lubricated at the factory, and lubrication with turbine oil, etc., will not satisfy the product's specifications.

6. Never reapply lubricant.

Never reapply lubricant, as there may be a degradation of particulate generation or operation characteristics.

Speed Adjustment

⚠ Caution

1. A throttle valve for clean room use is recommended for speed adjustment. (Consult SMC regarding equipment and methods to be used.)

Speed adjustment can also be performed with a meter-in or meter-out type speed controller for clean room use, but it may not be possible to obtain smooth starting and stopping operation.

Throttle valves and dual speed controllers for recommended speed adjustment of CYP cylinders

Throttle valve		Series	Model	
			CYP15	CYP32
Metal body piping type	Elbow type		10-AS1200-M5-X216	10-AS2200-01-X214
	In-line type		10-AS1000-M5-X214	10-AS2000-01-X209
Resin body with One-touch fitting	Elbow type (throttle valve)		10-AS1201F-M5-04-X214	10-AS2201F-01-04-X214
			10-AS1201F-M5-06-X214	10-AS2201F-01-06-X214
				10-AS2201F-01-06-X214
			10-AS1301F-M5-04-X214	10-AS2301F-01-04-X214
	Universal type (throttle valve)		10-AS1301F-M5-06-X214	10-AS2301F-01-06-X214
				10-AS2301F-01-06-X214
	In-line type (throttle valve)		10-AS1001F-04-X214	10-AS2001F-04-X214
			10-AS1001F-06-X214	10-AS2001F-06-X214
	Dual type (speed controller)		10-ASD230F-M5-04	10-ASD330F-01-06
			10-ASD230F-M5-06	10-ASD330F-01-08

2. In case of vertical mounting, a system with a reduced pressure supply circuit installed on the down side is recommended. (This is effective against upward starting delays and for conservation of air.)

Cushion Effect (Sine Cushion) and Stroke Adjustment

⚠ Caution

1. A sine cushion (smooth start, soft stop) function is included in the standard specifications.

Due to the nature of a sine cushion, adjustment of the cushion effect is not possible. There is no cushion needle adjustment as in the case of conventional cushion mechanisms.

2. The stroke end adjustment is a mechanism to adapt the slide table's stroke end position to a mechanical stopper on other equipment, etc.

(Adjustment range: Total of both sides $\pm 2\text{mm}$)
To ensure safety, perform adjustment after shutting off the drive air, releasing the residual pressure and implementing drop prevention measures, etc.

- 1) Loosen the inner cover holding screw with a hexagon wrench, etc.
- 2) To match the position with a mechanical stopper on other equipment, etc., rotate the stroke adjustment screw (inner cover) to the left or right with a flat head screw driver to move the inner stopper back and forth. Approximately 1mm of adjustment is possible with one rotation.
- 3) The maximum adjustment on one side is $\pm 1\text{mm}$. A total adjustment of approximately $\pm 2\text{mm}$ is possible using both sides.
- 4) After completing the stroke end adjustment, tighten the inner cover holding screw with a hexagon wrench, etc.

Inner cover holding screw tightening torque [N·m]

Model	Screw size	Tightening torque
CYP15	M3 x 0.5	0.3
CYP32	M6 x 1	2.45

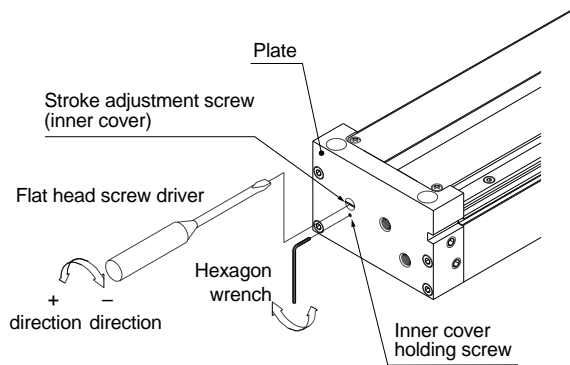

Maintenance

⚠ Caution

1. Never disassemble the cylinder tube or linear guide, etc.

If disassembled, the slide table may touch the outside surface of the cylinder tube resulting in a degradation of particulate generation characteristics.

2. Consult SMC when replacing seals and bearings (wear rings).

Particulate Generation Characteristics

⚠ Caution

1. In order to maintain the particulate generation grade, use operation of 500 thousand cycles or travel distance of about 400km as a standard. (Table 1 below)

If operation is continued beyond the recommended values, lubrication failure of the linear guide and loss of particulate generation characteristics may occur.

Table 1

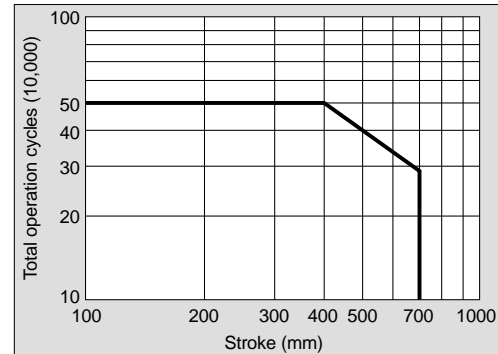
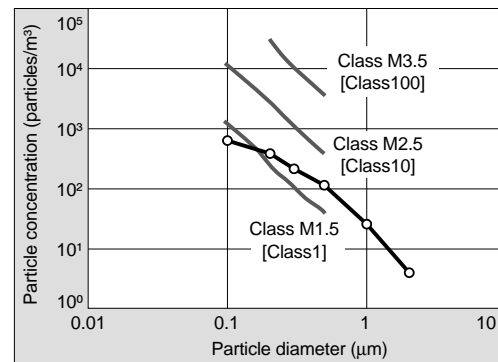

Table 2



- Note 1) This chart indicates the level of cleanliness inside the measurement chamber.
- Note 2) The vertical axis shows the number of particles per unit volume (1m^3) of air which are no smaller than the particle size shown on the horizontal axis.
- Note 3) The gray lines show the upper concentration limit of the cleanliness class based on Fed. Std. 209E-1992.
- Note 4) The plots indicate the 95% upper reliability limit value for time series data up to 500 thousand operation cycles. (Cylinder: CYP32-200, Work piece weight: 5kg, Average speed: 200mm/s)
- Note 5) The data above provides a guide for selection but is not guaranteed.

World Wide SMC Support...

North American Branch Offices For a branch office near you call: 1-800-SMC-SMC1 (762-7621)

SMC Pneumatics Inc. (Atlanta)
1440 Lakes Parkway, Suite 600
Lawrenceville, GA 30043
Tel: (770) 624-1940
FAX: (770) 624-1943

SMC Pneumatics Inc. (Detroit)
2990 Technology Drive
Rochester Hills, MI 48309
Tel: (248) 299-0202
FAX: (248) 293-3333

SMC Pneumatics Inc. (Rochester)
245 Summit Point Drive
Henrietta, NY 14467
Tel: (716) 321-1300
FAX: (716) 321-1865

SMC Pneumatics Inc. (Austin)
9101 Wall Street, Suite 1030
Austin, TX 78754
Tel: (512) 926-2646
FAX: (512) 926-7055

SMC Pneumatics Inc. (Houston)
9001 Jameel, Suite 180
Houston, TX 77040
Tel: (713) 460-0762
FAX: (713) 460-1510

SMC Pneumatics Inc. (S.F.)
85 Nicholson Lane
San Jose, CA 95134
Tel: (408) 943-9600
FAX: (408) 943-9111

SMC Pneumatics Inc. (Binghamton)
27 Link Drive
Binghamton, NY 13904
Tel: (607) 773-1300
Fax: (607) 773-8008

SMC Pneumatics Inc. (L.A.)
14191 Myford Road
Tustin, CA 92780
Tel: (714) 669-1701
FAX: (714) 669-1715

SMC Pneumatics Inc. (St. Louis)
4130 Rider Trail North
Earth City, MO 63045
Tel: (314) 209-0080
FAX: (314) 209-0085

SMC Pneumatics Inc. (Boston)
Zero Centennial Drive
Peabody, MA 01960
Tel: (978) 326-3600
Fax: (978) 326-3700

SMC Pneumatics Inc. (Milwaukee)
16850 W. Victor Road
New Berlin, WI 53151
Tel: (262) 827-0080
FAX: (262) 827-0092

SMC Pneumatics Inc. (Tampa)
8507-H Benjamin Road
Tampa, FL 33634
Tel: (813) 243-8350
FAX: (813) 243-8621

SMC Pneumatics Inc. (Charlotte)
5029-B West W.T. Harris Blvd.
Charlotte, NC 28269
Tel: (704) 597-9292
FAX: (704) 596-9561

SMC Pneumatics Inc. (Mnpls.)
990 Lone Oak Road, Suite 162
Eagan, MN 55121
Tel: (651) 688-3490
FAX: (651) 688-9013

SMC Pneumatics Inc. (Tulsa)
10203 A East 61st Street
Tulsa, OK 74146
Tel: (918) 252-7820
FAX: (918) 252-9511

SMC Pneumatics Inc. (Chicago)
27725 Diehl Road
Warrenville, IL 60555
Tel: (630) 393-0080
FAX: (630) 393-0084

SMC Pneumatics Inc. (Nashville)
5000 Linbar Drive, Suite 297
Nashville, TN 37211
Tel: (615) 331-0020
FAX: (615) 331-9950

SMC Pneumatics Inc. (Cincinnati)
4598 Olympic Blvd.
Erlanger, KY 41018
Tel: (859) 647-5600
FAX: (859) 647-5609

SMC Pneumatics Inc. (Newark)
3434 US Hwy. 22 West, Ste. 110
Somerville, NJ 08876
Tel: (908) 253-3241
FAX: (908) 253-3452

SMC Pneumatics Inc. (Cleveland)
2305 East Aurora Rd., Unit A-3
Twinsburg, OH 44087
Tel: (330) 963-2727
FAX: (330) 963-2730

SMC Pneumatics Inc. (Phoenix)
2001 W. Melinda Lane
Phoenix, AZ 85027
Tel: (623) 492-0908
FAX: (623) 492-9493

SMC Pneumatics Inc. (Columbus)
3687 Corporate Drive
Columbus, OH 43231
Tel: (614) 895-9765
FAX: (614) 895-9780

SMC Pneumatics Inc. (Portland)
14107 N.E. Airport Way
Portland, OR 97230
Tel: (503) 252-9299
FAX: (503) 252-9253

SMC Pneumatics Inc. (Dallas)
12801 N. Stemmons Frwy, Ste. 815
Dallas, TX 75234
Tel: (972) 406-0082
FAX: (972) 406-9904

SMC Pneumatics Inc. (Richmond)
5377 Glen Alden Drive
Richmond, VA 23231
Tel: (804) 222-2762
FAX: (804) 222-5221

Europe
ENGLAND
SMC Pneumatics (U.K.) Ltd.
GERMANY
SMC Pneumatik GmbH
ITALY
SMC Italia SpA
FRANCE
SMC Pneumatique SA
HOLLAND
SMC Controls BV
SWEDEN
SMC Pneumatics Sweden AB
SWITZERLAND
SMC Pneumatik AG
AUSTRIA
SMC Pneumatik GmbH
SPAIN
SMC España, S.A.
IRELAND
SMC Pneumatics (Ireland) Ltd.

SMC Thailand Ltd.
INDIA
SMC Pneumatics (India) Pvt., Ltd.
North America
CANADA
SMC Pneumatics (Canada) Ltd.
MEXICO
SMC Pneumatics (Mexico) S.A. de C.V.

South America
ARGENTINA
SMC Argentina S.A.
CHILE
SMC Pneumatics (Chile) Ltda.

Oceania
AUSTRALIA
SMC Pneumatics (Australia) Pty. Ltd.
NEW ZEALAND
SMC Pneumatics (N.Z.) Ltd.

Asia
JAPAN
SMC Corporation
KOREA
SMC Pneumatics Korea Co., Ltd.
CHINA
SMC (China) Co., Ltd.
HONG KONG
SMC Pneumatics (Hong Kong) Ltd.
SINGAPORE
SMC Pneumatics (S.E.A.) Pte. Ltd.
PHILIPPINES
SMC Pneumatics (Philippines), Inc.
MALAYSIA
SMC Pneumatics (S.E.A.) Sdn. Bhd.
TAIWAN
SMC Pneumatics (Taiwan) Co., Ltd.
THAILAND

SMC offers the same quality and engineering expertise in many other pneumatic components

Valves

Directional Control Valves
Manual Valves
Mufflers
Exhaust Cleaners
Quick Exhaust Valves

Valves

Proportional Valves
Mechanical Valves
Miniature Valves
Fluid Valves

Cylinders/Actuators

Compact Cylinders
Miniature Cylinders
Rodless Cylinders
Rotary Actuators
Pneumatic Grippers

Vacuum

Vacuum Ejectors
Vacuum Accessories

Instrumentation

Pneumatic Positioners
Pneumatic Transducers

Air Preparation Equipment

Filters-Regulators-Lubricators
Coalescing Filters
Micro Mist Separators

Fittings

Air Fittings

SMC Pneumatics Inc.

P.O. Box 26640, Indianapolis, IN 46226
Tel: (317) 899-4440 • FAX: (317) 899-3102