

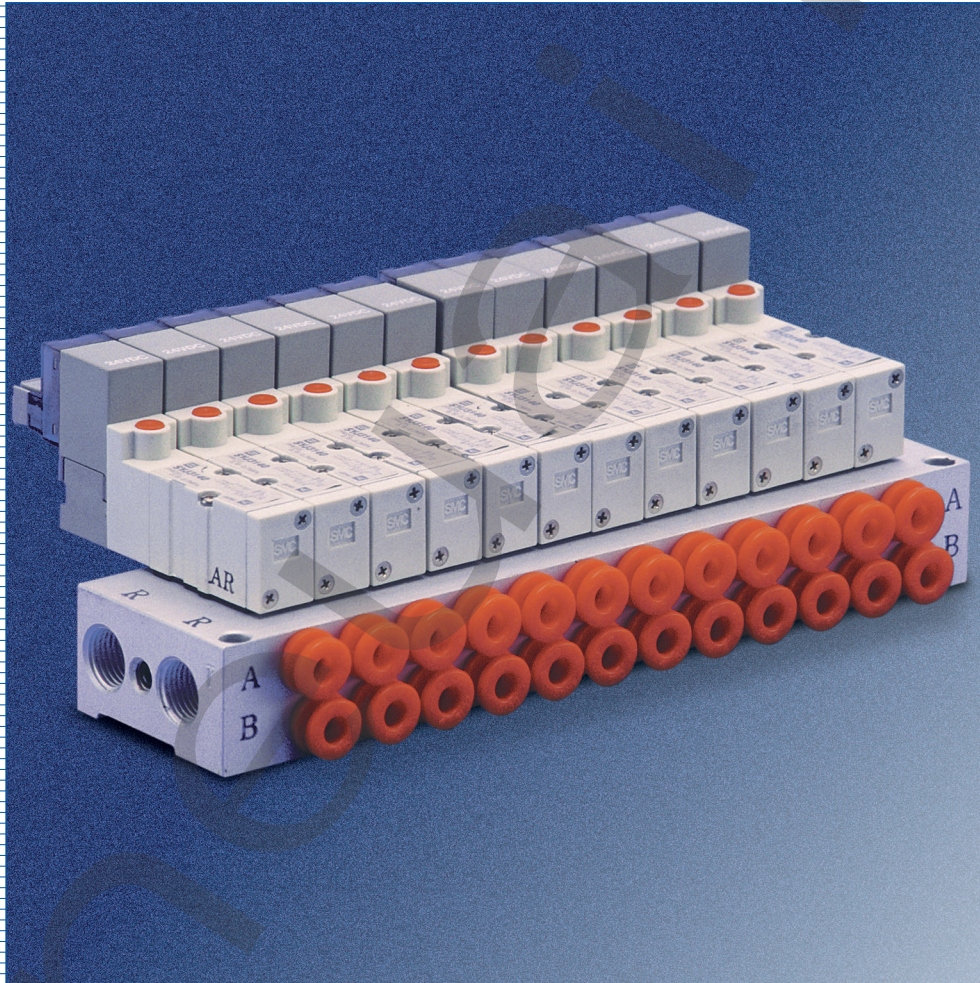

4 Way • 4 and 5 Port

Series SYJ3000

Rubber Seal • Solenoid Pilot Valve



PRODUCTS™

Interchangeable with the NVJ Series
Low Power Consumption: 0.5W
Base Mounted/Body Ported Configurations
Manifolds with Built-in 'One-Touch' Fittings



ORDER
ONLINE

Table of Contents

Features & Benefits4-5

Preferred Option Program6

Specifications

Valve8
Manifold9

How To Order

Valve12
Manifold13-14
Accessories15

Additional Options

Air Pilot Type18-19
Power Conserving Type.....20

Drawings

Valve22-28
Manifold29-34

Operations Guide

System Design.....36
Installation37
Maintenance38
Manual Override39
Surge Suppressor40
Wiring.....41
Mixed Mounting of 3 & 4 Way Valves42



Targeting new trends in the advancement of industrial automation, P/A has developed a category of products recognized as especially significant and of universal importance. We refer to these products as “Z Products.” These revolutionary products, whether simple or complex, provide P/A customers with superior performance and availability at a very affordable cost.

Series SYJ3000

Low Power Consumption: 0.5W (Current draw: 21 mA at 24VDC)

Low power consumption enables direct operation by a PLC. Cost savings are realized through the use of a smaller power supply and the elimination of relay cards.

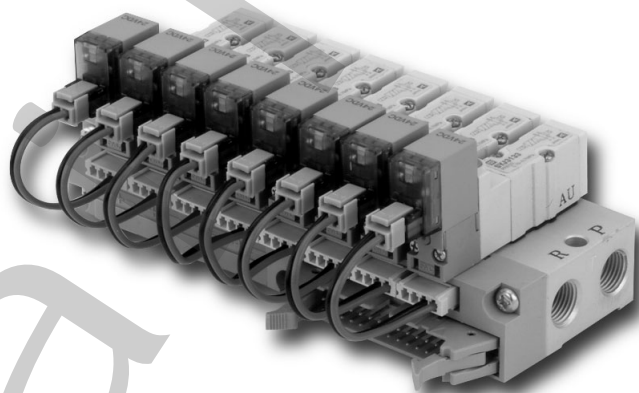

Compact Design

The SYJ produces a high flow rate (Cv0.1) while maintaining a slim profile (10mm width).

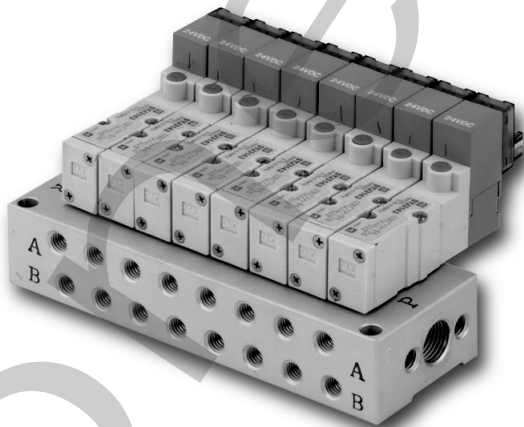

Refined Appearance and State-of-the-Art Design

The clean, bright appearance of the SYJ has been adopted to complement modern equipment design.

4, 5 Port Solenoid Valve

Completely Interchangeable with the Previous NVJ Series

Mounts on the same subplates and manifolds as the NVJ3000 valves.

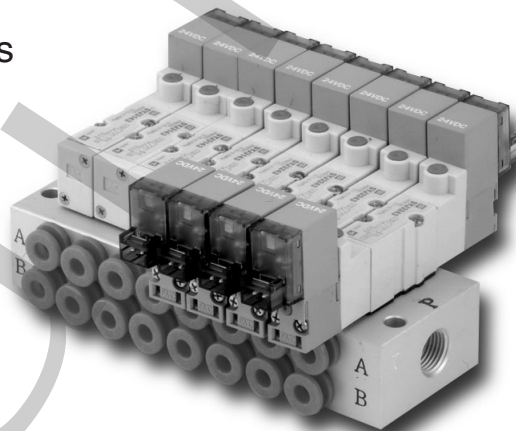

Labor Saving Features

Options, such as built-in “one-touch” fittings and flat ribbon cable connectors, simplify installation and reduce setup time.

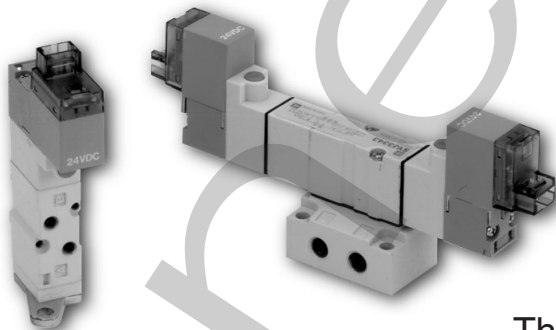

Common Exhaust

Valves can be ordered with a common exhaust port for the pilot and main valve. This option provides for a cleaner operating environment by exhausting the pilot air through the main valve body rather than directly to the atmosphere.

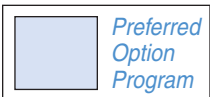



Preferred
Option
Program

The Preferred Option Program: "Quick Delivery and Service Assurance"

The product series in this catalog utilizes P/A's Preferred Option Program, a unique program intended to emphasize the model configurations that are most readily available where the catalog presents an extensive variety of choice. All other options are available, whereas they may be stocked in lesser quantities or manufactured to order. Special arrangements can be made for repeating (blanket) orders of these product models. Contact your sales representative for further details.

SYJ3000 Preferred Option Summary

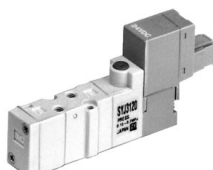
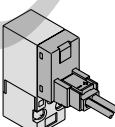
Valve

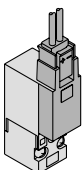
	Series	Port size	Effective area mm ² (Cv)	Type of actuation	Voltages	Electrical entry	Option	Manual override	Pilot exhaust
							Light and surge voltage suppressor		
Body ported	SYJ3000 	M3×0.5	0.9(0.05)	2 position	DC	L type plug connector 	■ With light and surge voltage suppressor	■ Non-locking push type	■ Common for pilot and main valve
				<ul style="list-style-type: none"> ● Single ● Double 					
Base mounted	SYJ3000 	M5×0.8	1.8(0.1)	3 position		M type plug connector 			
				<ul style="list-style-type: none"> ● Closed center ● Exhaust center 					

Manifold

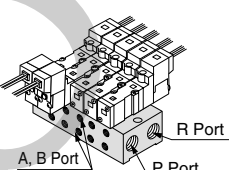
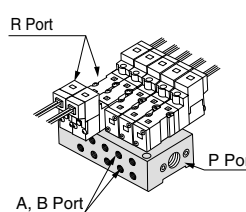
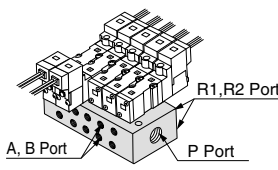
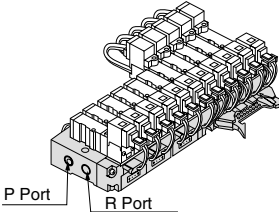
Series	Type 32	Type 41	Type 46	Type 32P
SYJ3000 Base Mounted Manifolds				
	A, B Port R Port P Port	R Port A, B Port P Port	A, B Port R1, R2 Port P Port	P Port R Port

Specifications

Series SYJ3000

■ Valve	8
■ Manifold.....	9

- High Flow: Cv0.1
- Low Power Consumption: 0.5W
- High Speed Response: 15ms
- Light Weight (33g)

Series SYJ3000

Valve Specifications

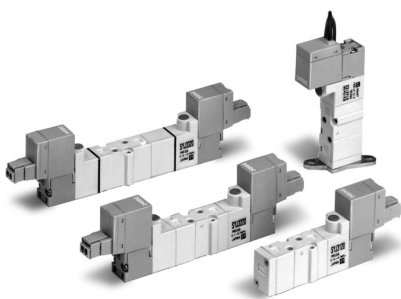

Body ported type

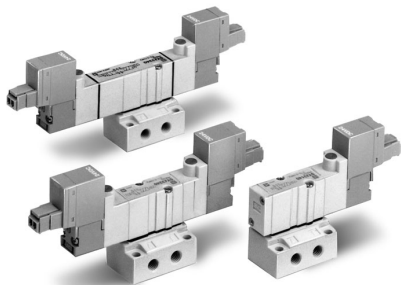

Base mounted type

Model

Valve model	Type of actuation	Port size	Effective area mm ² (Cv)	Weight g ^{Note 2, 3)}	
				Grommet	L type, M type plug connector
5 Port Body ported type	2 position	Single	0.9 (0.05)	33	35
		Double		47	51
	3 position	Closed center		50	54
		Exhaust center			
		Pressure center			
5 Port Base mounted type (With sub-plate)	2 position	Single	1.8 (0.1)	59(33)	61(35)
		Double		73(47)	77(51)
	3 position	Closed center		76(50)	80(54)
		Exhaust center			
		Pressure center			
4 Port Base mounted type (For manifold use only)	2 position	Single	Note1) 1.2 (0.067)	33	35
		Double		47	51
	3 position	Closed center		50	54
		Exhaust center			
		Pressure center			

Note1) In case of M5 and mounted on manifold base.

Note2) () :Without sub-plate.

Note3) For DC voltages. For AC voltages add 1g to the weight of the single solenoid and 2g to the weight of the double solenoid and 3 position types.

JIS Symbol 5 Port

2 Position single

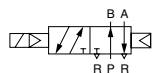

2 Position double

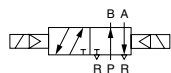

3 Position closed center

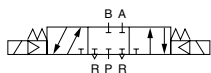

3 Position exhaust center

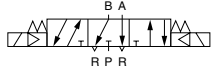

3 Position pressure center

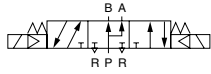

JIS Symbol 4 Port(manifold)

2 Position single

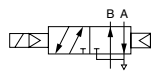

2 Position double

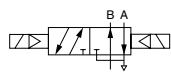

3 Position closed center

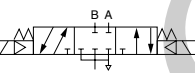

3 Position exhaust center

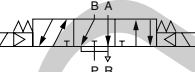

3 Position pressure center

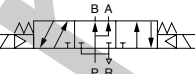

Specifications

Fluid	Air	
Operating pressure range PSI (MPa)	2 position single	22 ~ 100 (0.15 to 0.7)
	2 position double	15 ~ 100 (0.1 to 0.7)
	3 position	30 ~ 100 (0.2 to 0.7)
Ambient and fluid temperature (°F)	Max.122	
Response time (ms)	2 position single,double	15 or less
	3 position	30 or less
Max. operating frequency (Hz)	2 position single,double	10
	3 position	3
Manual override	Non-locking push type, Push-locking slotted type	
Pilot exhaust	Individual pilot exhaust type, common exhaust(pilot and main valve)type	
Lubrication	Not required	
Mounting position	Free	
Impact / Vibration resistance (m/s ²)	150/30	
Protection structure	Dust proof	

Solenoid Specifications

Electrical entry	Grommet(G)/(H), L type plug connector(L), M type plug connector(M)		
Coil rated voltage (V)	DC	24,12,6,5,3	
	AC50/60Hz	100, 110, *200, 220 **	
Allowable voltage	±10% rated voltage		
Power consumption (W) ^{Note4)}	DC	0.5(With light:0.55)	
Apparent power (VA)	AC	100V	0.9(With light:1.0)
		110V [115V]	1.0(With light:1.1) [1.1(With light:1.2)]
		200V	1.8(With light:1.9)
		220V [230V]	1.9(With light:2.0) [2.2(With light:2.3)]
Surge voltage suppressor	Diode		
Indicator light	LED		

* Can be used for 115VAC in common.

** Can be used for 230VAC in common.

Note 4) At rated voltage

Standard

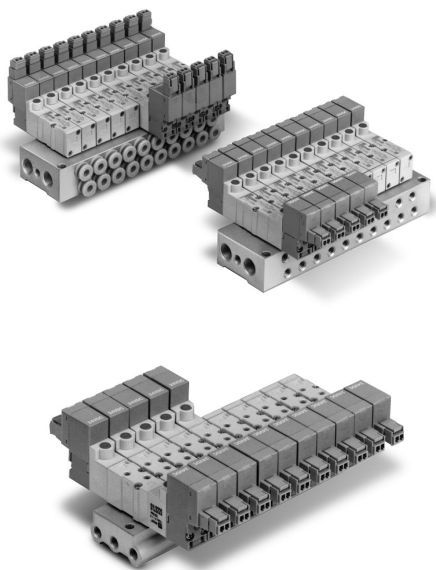

Manifold Specifications

Type	Type 20	Type 31,S31	Type 32,S32	Type 41,S41	Type 46,S46
Manifold type	Single base type/B mount				
P(SUP) / R(EXH) type	Common SUP, Common EXH				Common SUP Individual EXH
Valve stations	2 to 20 stations				
A, B port specifications	Location	Valve	Base		
	Direction	Top	Side		
Port size	P, R port	M5×0.8	1/8 NPTF		P:1/8 NPTF R:M5×0.8
	A, B port	M3×0.5	M5×0.8,N3T (ø5/32 one touch fitting)		
Effective area ^{Note)} mm ² (Cv)	Body ported type SYJ3 □ □	0.9 (0.05)	—	—	—
	Base mounted type SYJ3 □ □	—	0.9 (0.05)	1.2(0.067)	—
	Base mounted type SYJ3 □ □	—	—	1.5(0.08)	1.0(0.055)

Note) Value for a single solenoid 2 position valve mounted on the manifold.

Flat Cable Manifold

- Multiple valve wiring is consolidated through the use of the flat cable connector.
- Simplifies Installation
- Clean appearance

With the flat cable manifold, each valve is wired to the manifold base.
A single MIL specification flat cable connects the entire manifold to the power source.
This greatly reduces installation time.

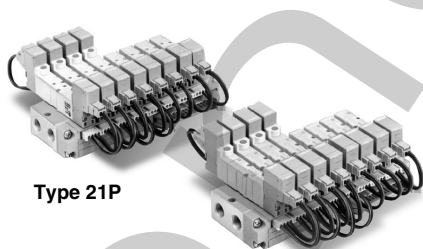

Type 21P

Type 32P

Manifold Specifications

Type	Type 21P	Type 32P
Manifold type	Single base type/B mount	
P(SUP) / R(EXH) type	Common SUP / Common EXH	
Valve stations	4 to 12 stations	
A, B port specifications	Location	Base
	Direction	Side
Port size	P, R port	1/8 NPTF
	A, B port	M3×0.5 M5×0.8,N3T (ø5/32 one touch fitting)
Effective area ^{Note 1)} mm ² (Cv)	SYJ3 □23	1.2(0.067)
	SYJ3 □33	—
Connector	Socket : 26 poles MIL type with strain relief conforms to MIL-C-83503	
Internal wiring ^{Note 2)}	Both for +COM and -COM	
Applicable solenoid valve	SYJ3 □23-5/8 LOU □ -M3	SYJ3 □33-5/8 LOU □
Rated voltage	24VDC, 12VDC	

Note 1) Value for a single solenoid 2 position valve mounted on manifold base.

Note 2) The manifold can be wired for either positive or negative common because only non-polar valves are used.
The use of valves other than non-polar types is not recommended and may cause damage to the electrical circuit.

How To Order

Series SYJ3000

■ Valve	12
■ Manifold	13-14
■ Accessories	15

- Base Mounted / Body Ported Types
- Wide Variety of Electrical Entries
- Indicator Lights & Surge Voltage Suppressor
- Manifolds with Built-in Fittings

How To Order: Valve

Rated voltage

For DC

5	24VDC
6	12VDC
V	6VDC
S	5VDC
R	3VDC

For AC (50/60Hz)

1	100VAC
2	200VAC
3	110VAC[115VAC]
4	220VAC[230VAC]

Bracket

— : Without bracket
F : With bracket

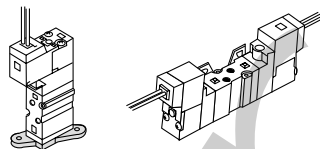

Single Double

Note) The double sol. mounting bracket is supplied unattached.

Preferred
Option
Program

Body ported	SYJ3	1	2	3	5	LZ		M3	
Base mounted (4 Port)	SYJ3	2	3	3	5	LZ			
Base mounted (5 Port)	SYJ3	2	4	3	5	LZ			

Port size

— : Without sub-plate

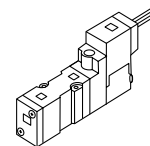

(With gasket and screws)

M5 : With sub-plate

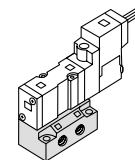

Type of actuation

1	2 Position single solenoid
2	2 Position double solenoid
3	3 Position closed center
4	3 Position exhaust center
5	3 Position pressure center

Manual override

— : Non-locking push type

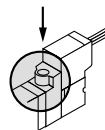

D : Push locking slotted type

Body option

0 : Individual exhaust for the pilot valve 3 : Common exhaust for the pilot and main valve

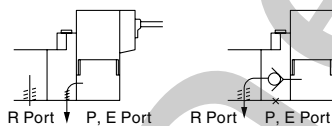

Electrical entry

24, 12, 6, 5, 3VDC / 100, 110, 200, 220VAC		
Grommet	L type plug connector	M type plug connector
 G: 300mm lead wire H: 600mm lead wire	 L: 300mm lead wire LZ: Lead wire w/ light & surge suppression LO: Without LOZ: W/out lead wire with light & surge suppression LOJ: W/out lead wire with light & surge suppression for flat cable manifold	 M: With lead wire (Length: 300mm) MZ: Lead wire w/light & surge suppression MO: Without MOZ: W/out lead wire with light & surge suppression

How To Order: Manifold (Common SUP/Common EXH)



Type 20(5 Port / Body ported type)

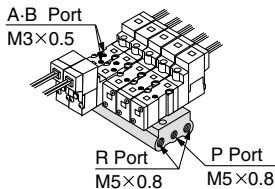

SS5YJ3-20-

Valve stations	
02	2 stations
:	:
20	20 stations

Applicable solenoid valve:
SYJ3□20-□□□□-M3
SYJ3□23-□□□□-M3

Applicable blank plate ass'y:
SYJ3000-21-1A

Type 31(4 Port / Base mounted type)

Type 31 Type S31 (Single solenoid coil is located on same side as the A, B port.)

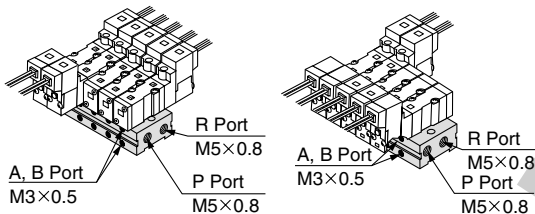

SS5YJ3-□31-05-M3

Valve mounting direction	
-	Single solenoid coil is located on the opposite side of the A, B port.
S	Single solenoid coil is located on same side as the A, B port.

Valve stations	
02	2 stations
:	:
20	20 stations

Applicable solenoid valve:
SYJ3□30-□□□□
SYJ3□33-□□□□

Type 32(4 Port / Base mounted type)

Type 32 Type S32 (Single solenoid coil is located on same side as the A, B port.)

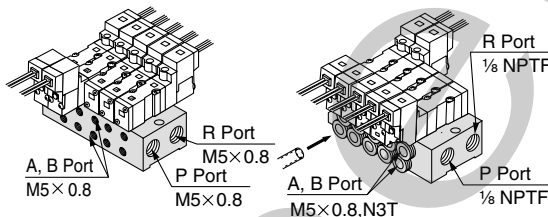

SS5YJ3-□32-05-M5T

Valve mounting direction	
-	Single solenoid coil is located on the opposite side of the A, B port.
S	Single solenoid coil is located on same side as the A, B port.

Valve stations	
02	2 stations
:	:
20	20 stations

A,B port size	
M5T	M5x0.8
N3T	5/32 One-touch fitting

Applicable blank plate ass'y:
SYJ3000-21-2A

Type 41(5 Port / Base mounted type)

Type 41 Type S41 (Single solenoid coil is located on same side as the A, B port.)

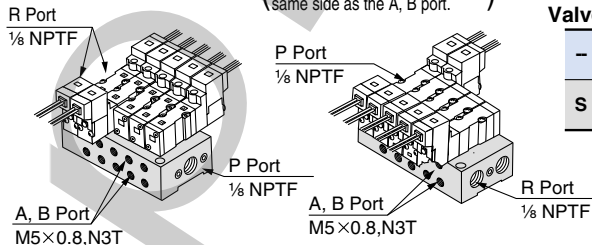

SS5YJ3-□41-05-N3T

Valve mounting direction	
-	Single solenoid coil is located on the opposite side of the A, B port.
S	Single solenoid coil is located on same side as the A, B port.

Valve stations	
02	2 stations
:	:
20	20 stations

A,B port size	
M5T	M5x0.8
N3T	5/32 One-touch fitting

Applicable solenoid valve:
SYJ3□40-□□□□
SYJ3□43-□□□□

Applicable blank plate ass'y:
SYJ3000-21-2A

Series SYJ3000

How To Order

How To Order: Manifold (Common SUP/Individual EXH)



Type 46(5 Port / Base mounted type)

SS5YJ3- 46-05-M5T

Applicable solenoid valve:
SYJ3□40-□□□□
SYJ3□43-□□□□

Applicable blank plate ass'y:
SYJ3000-21-2A

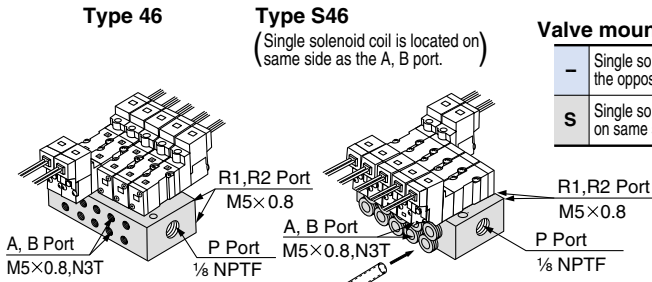

Valve mounting direction

-	Single solenoid coil is located on the opposite side of the A, B port.
S	Single solenoid coil is located on same side as the A, B port.

Valve stations

02	2 stations
:	:
20	20 stations

A, B port side

M5T	M5×0.8
N3T	5/32 One-touch fitting

How To Order: Flat Ribbon Cable Manifold

Type 21P (4 Port/Body Ported Type)

SS5YJ3-21P- 07 - 00T

Applicable valve:
SYJ3□23 — 5/16 LOU□-M3
SYJ3□23Y — 5/16 LOU□-M3

Applicable connector ass'y:
SY3000-37-28A (For 2 position single)
SY3000-37-29A (For 2 position double, 3 position)

Applicable blank plate ass'y:
SYJ3000-21-3A (With dust cap)

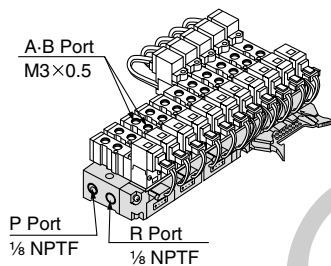

Stations

04	4 stations
:	:
12	12 stations

Type 32P (4 Port/Base Mounted Type)

SS5YJ3-32P- 07-M5T

Applicable valve:
SYJ3□33 — 5/16 LOU□
SYJ3□33Y — 5/16 LOU□

Applicable connector ass'y:
SY3000-37-28A (For 2 position single)
SY3000-37-29A (For 2 position double, 3 position)

Applicable blank plate ass'y:
SYJ3000-21-4A (With dust cap)

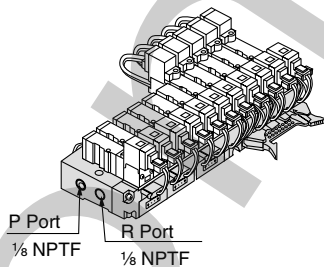

Valve stations

04	4 stations
:	:
12	12 stations

A, B port side

M5T	M5×0.8
N3T	5/32 One-touch fitting

How to Order Pilot Valve Ass'y

SY114 — **5** **G** **□**

Voltage

5	24VDC
6	12VDC
V	6VDC
S	5VDC
R	3VDC
1	100VAC50/60Hz
2	200VAC50/60Hz
3	110VAC50/60Hz [115VAC50/60Hz]
4	220VAC50/60Hz [230VAC50/60Hz]

Electrical entry

G	Grommet (Lead wire length:300mm)
H	Grommet (Lead wire length:600mm)
L	L type plug connector
LN	L type plug connector
LO	L type plug connector
M	M type plug connector
MN	M type plug connector
MO	M type plug connector

Indicator light and surge voltage suppressor

—	Without indicator light and surge voltage suppressor
S	With surge voltage suppressor
Z	With indicator light and surge voltage suppressor
U	With indicator light and surge voltage suppressor (Non-polar type)

*"U" type is only available for 24VDC and 12VDC.
*For AC voltage valves there is no "S" option since the rectifier circuit incorporates a surge suppressor already.

How to Order Connector Ass'y

DC : SY100-30-4A-**□**
 100VAC : SY100-30-1A-**□**
 200VAC : SY100-30-2A-**□**
 Other AC voltages : SY100-30-3A-**□**

Lead wire length

—	300mm
6	600mm
10	1000mm
15	1500mm
20	2000mm
25	2500mm
30	3000mm
50	5000mm

Proper Combination of Blank Plate Ass'y and Manifold Base

Blank plate ass'y SYJ3000-21-1A

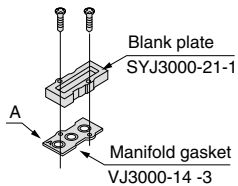

Applicable manifold base
SS5YJ3-20

Note) Manifold gasket "VJ3000-14-2" can be used with the following manifold bases.

- SS5YJ3-31
- SS5YJ3-S31
- SS5YJ3-32
- SS5YJ3-S32

Blank plate ass'y SYJ3000-21-2A

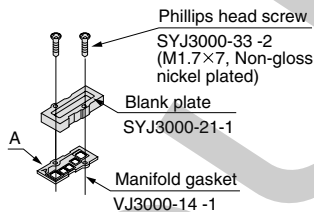

Applicable manifold base (sub-plate)
SS5YJ3-41 SS5YJ3-31
SS5YJ3-S41 SS5YJ3-S31
SS5YJ3-46 SS5YJ3-32
SS5YJ3-S46 SS5YJ3-S32

Blank plate ass'y SYJ3000-21-4A

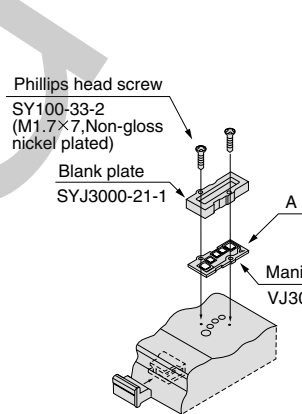

Applicable manifold base
SS5YJ3-32P

Blank plate ass'y SYJ3000-21-3A

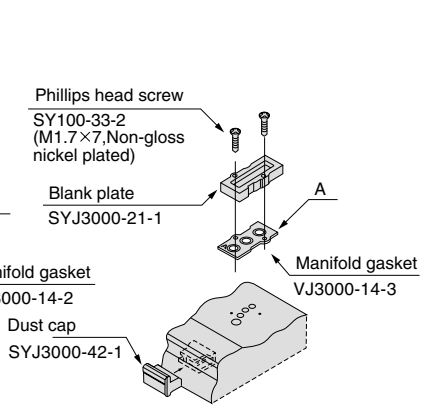

Applicable manifold base
SS5YJ3-21P

Proper Combination of Solenoid Valve, Manifold Gasket and Manifold Base

5 Port body ported type (SYJ3□2³)

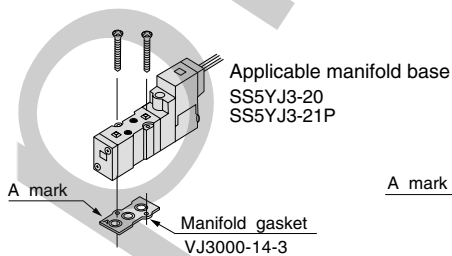

Applicable manifold base
SS5YJ3-20
SS5YJ3-21P

4 Port base mounted type (SYJ3□3³)

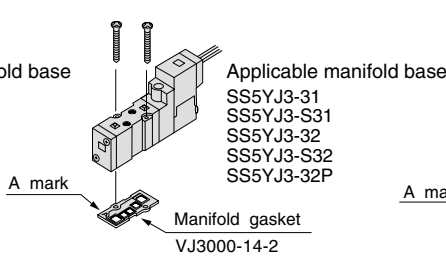

Applicable manifold base
SS5YJ3-31
SS5YJ3-S31
SS5YJ3-32
SS5YJ3-S32
SS5YJ3-32P

5 Port base mounted type (SYJ3□4³)

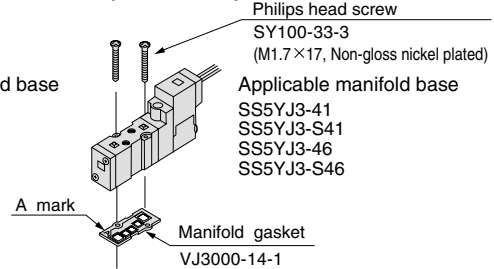

Applicable manifold base
SS5YJ3-41
SS5YJ3-S41
SS5YJ3-46
SS5YJ3-S46

Additional Options

Series SYJ3000

■ Air Pilot Type.....	18-19
■ Power Conserving Type.....	20

- Air Pilots for Air Logic Applications
- Perfect for Applications where Electricity is Unavailable
- Power Saving Type Decreases Holding Wattage by 1/2
- Lowers Operating Cost

Series SYJ3000

Air Pilot Type

Specifications

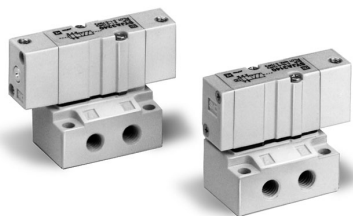

Base mounted type

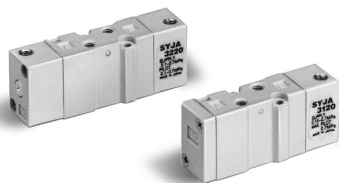

Body ported type

Model

	Valve model	Type of actuation	Port size	Effective area mm ² (Cv)	Pilot port size	Note2) Weight g
Body ported type	SYJA3120-M3	2 Position single	M3×0.5	0.9 (0.05)	M3×0.5	22
	SYJA3220-M3	2 Position double				25
	SYJA3320-M3	3 Position closed center				28
	SYJA3420-M3	3 Position exhaust center				
	SYJA3520-M3	3 Position pressure center				
5 Port base mounted type (With sub-plate)	SYJA3140-M5	2 Position single	M5×0.8	1.8 (0.1)	M3×0.5	48(22)
	SYJA3240-M5	2 Position double				51(25)
	SYJA3340-M5	3 Position closed center				54 (28)
	SYJA3440-M5	3 Position exhaust center				
	SYJA3540-M5	3 Position pressure center				
14 Port base mounted type (For manifold)	SYJA3130	2 Position single	M3×0.5 Note1)	1.2 Note1) (0.067)	M3×0.5	22
	SYJA3230	2 Position double				25
	SYJA3330	3 Position closed center	M5×0.8			28
	SYJA3430	3 Position exhaust center				
	SYJA3530	3 Position pressure center				

Note1) Value when used on a manifold.

Note2) (): Without sub-plate

Note3) Model number for 5 port base mounted type without sub-plate is SYJA3□40.

With Bracket

Air operated valve part No.	SYJA3□20-M3-F
------------------------------------	---------------

The mounting bracket for the 2 position double solenoid and 3 position is supplied unattached.

JIS symbol 5 Port

2 Position single

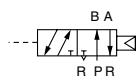

2 Position double

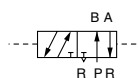

3 Position closed center

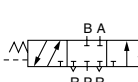

3 Position exhaust center

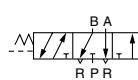

3 Position pressure center

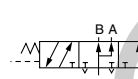

4 Port

2 Position single

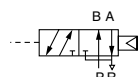

2 Position double

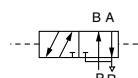

3 Position closed center

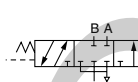

3 Position exhaust center

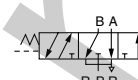

3 Position pressure center

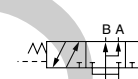

Specifications

Fluid	Air	
Operating pressure range PSI (MPa)	2 Position single	22~100 (0.15~0.7)
	2 Position double	15~100 (0.1~0.7)
	3 Position	22~100 (0.15~0.7)
Pilot pressure range PSI (MPa)	2 Position single	Operating pressure to 100 (Operating pressure to 0.7)
	2 Position double	
	3 Position	
Ambient and fluid temperature (°F)	Max.140	
Lubrication	Not required	
Mounting position	Free	
Impact/Vibration resistance (m/s ²)	300/50	

Pilot pressure range(Single pilot)

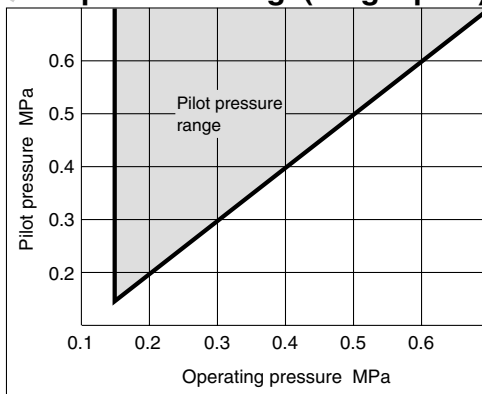

How to Order Valve Manifold

Uses the same manifold bases as the SYJ3000 series.

<Example>

- SS5YJ3-41-03-M5T 1pc.
- SYJA3140 1pc.
- SYJA3240 1pc.
- SYJ3000-21-2A 1pc.

Body Ported Type / Dimensions

2 Position single: SYJA3120-M3(-F)

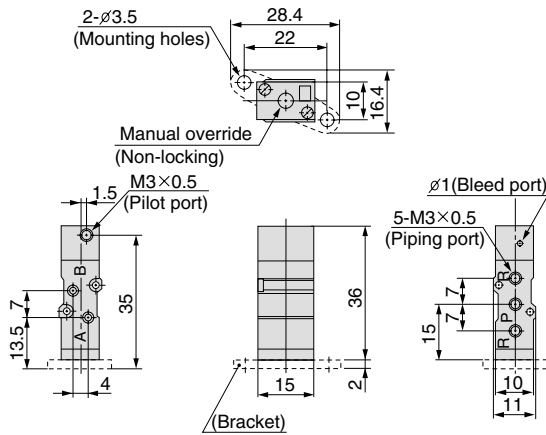

Base Mounted Type / Dimensions

2 Position single: SYJA3140-M5

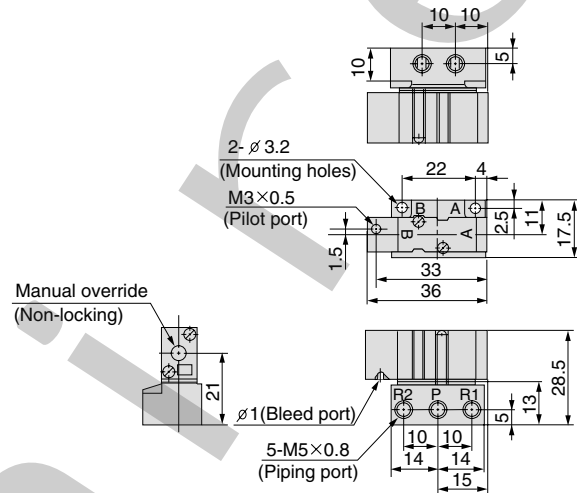

2 Position double: SYJA3220-M3(-F)

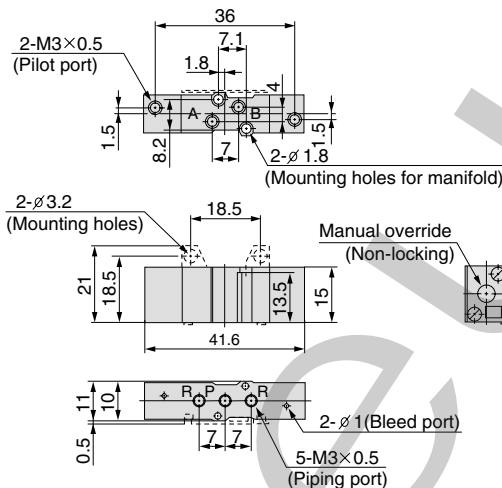

2 Position double: SYJA3240-M5

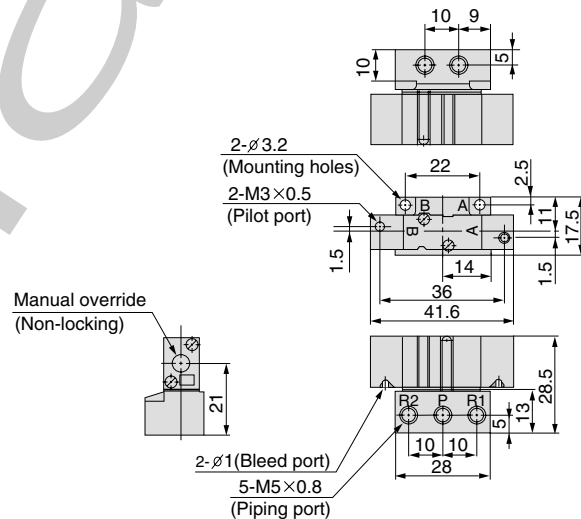

3 Position closed center / exhaust center / pressure center : SYJA3³/₄20-M3(-F)

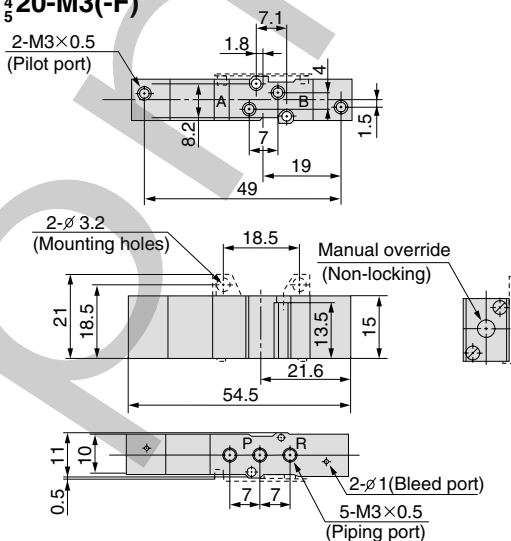

3 Position closed center / exhaust center / pressure center : SYJA3³/₅40-M5

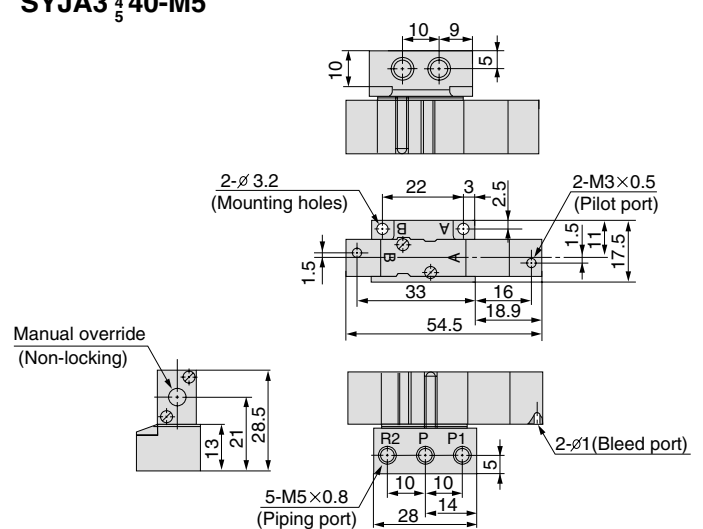

Series SYJ3000

Power Conserving Type

Power Conserving Type

Power consumption is decreased one half by reducing the wattage required to hold the valve in an energized state.

Specifications

Series	SYJ3000T	
Coil rated voltage V	12, 24DC	
Power consumption W	Starting	0.55
	Holding	0.22

Specifications other than above are the same as standard models.

How to Order

SYJ 3 T- Z- - -

• **Rated voltage**

5	24VDC
6	12VDC

• **Specify the same as standard**

Operating principle

The circuit shown below reduces current consumption at holding which reduces the overall power consumption. Refer to following power wave form.

Electrical circuit (For power saving type)

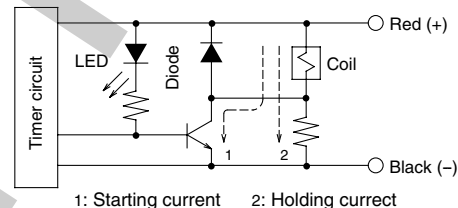

<Power saving type power wave type SYJ3000T>

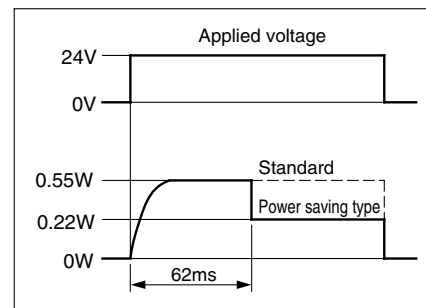

Drawings

Series SYJ3000

■ Valve	22-28
■ Manifold	29-34

- List of Spare Parts
- Valve Drawings for Each Electrical Entry
- All Drawings in Millimeters
- Manifold Drawings for all Types

Series SYJ3000

Construction Drawings

Construction

2 position single

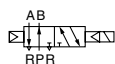

2 position double

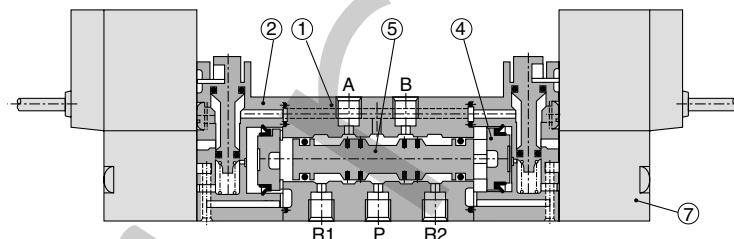
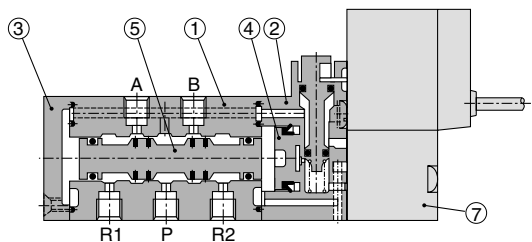
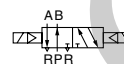

3 position closed center/exhaust center/pressure center

3 position closed center

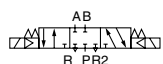

3 position exhaust center

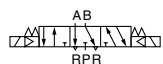

3 position pressure center

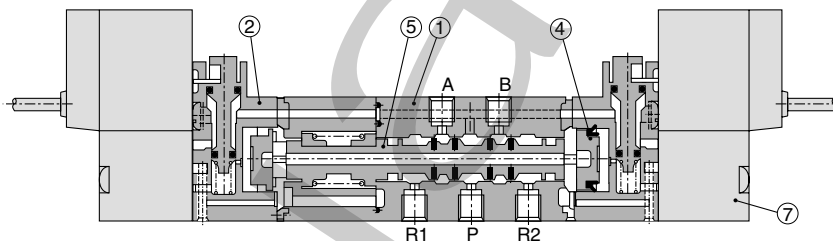
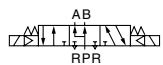

(This construction shows closed center type.)

Main parts

No.	Description	Material	Note
①	Body	Zinc die cast	White
②	Piston plate	Resin	White
③	End cover	Resin	White
④	Piston	Resin	—
⑤	Spool ass'y	—	—

Replaceable parts

No.	Description	Part No.	Note
⑥	Sub-plate	SYJ3000 - 22-1	Zinc die cast
⑦	Pilot valve	SY114-□□□	

Valve Drawings

2 Position Single

Series SYJ3000

(mm)

Grommet (G), (H) : SYJ3120-□_G□□-M3

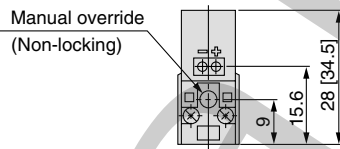
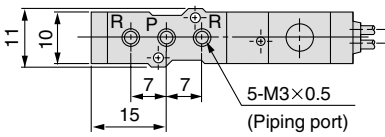
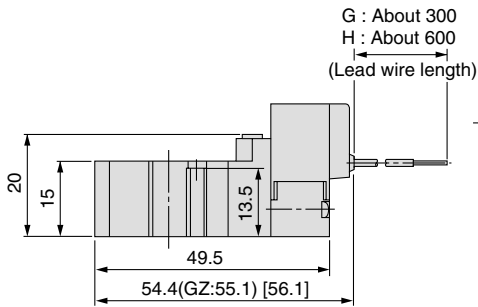
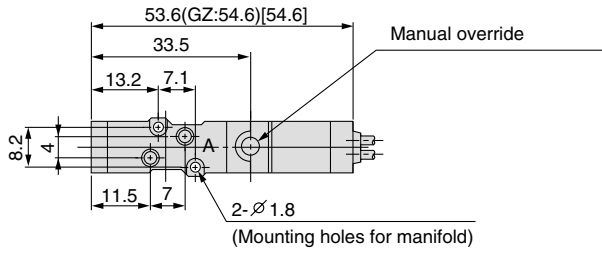

With bracket

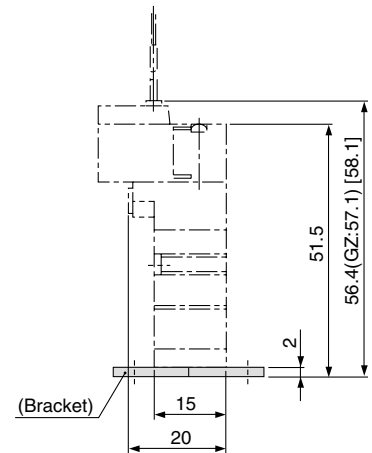
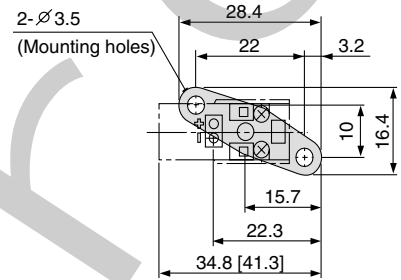

* [] for AC
* Other dimensions are the same as the grommet type.

* [] for AC

L type plug connector (L) : SYJ3120-□L□□-M3

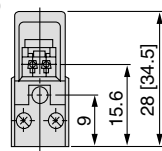
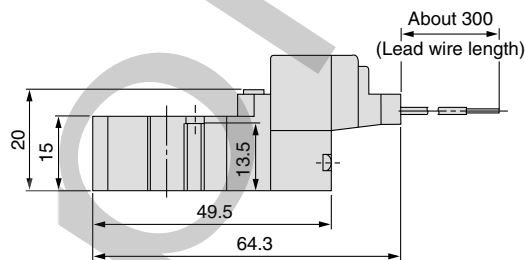
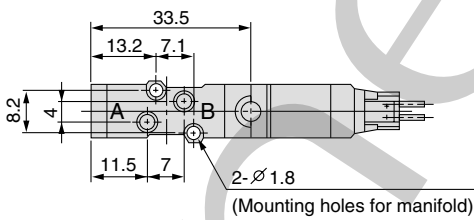

M type plug connector (M) : SYJ3120-□M□□-M3

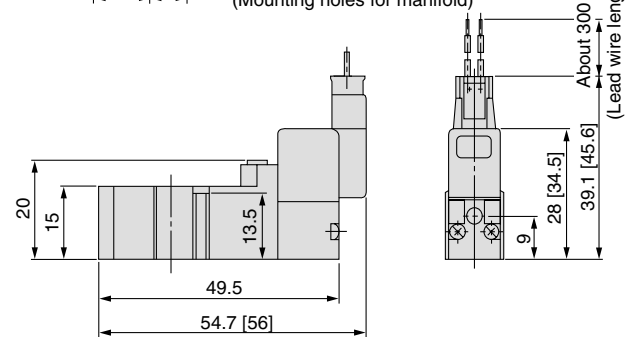
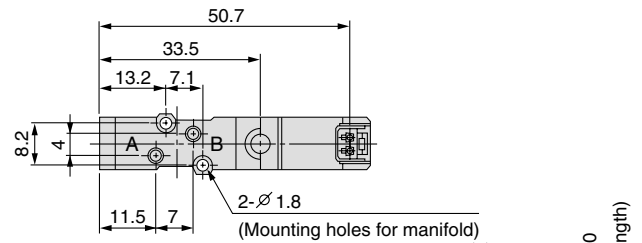

* [] for AC
* Other dimensions are the same as the grommet type.

* [] for AC
* Other dimensions are the same as the grommet type.

Series SYJ3000

Valve Drawings

2 Position Double

(mm)

Grommet (G), (H) : SYJ3220-GH-M3

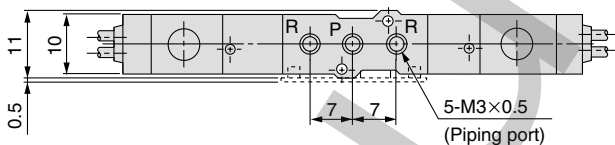
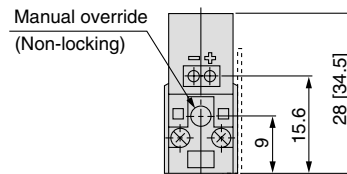
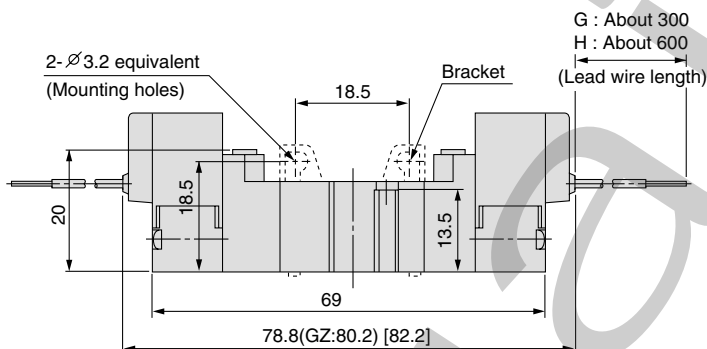
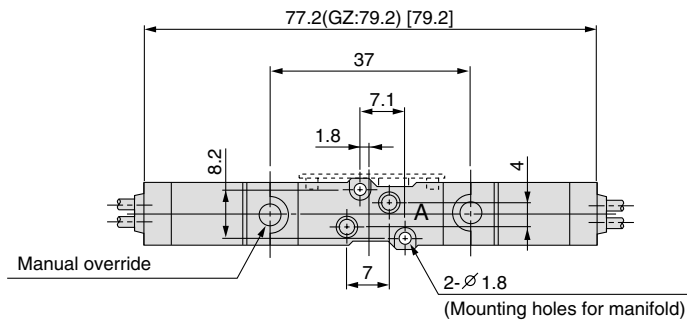

*[] for AC

L type plug connector (L) : SYJ3220-L-M3

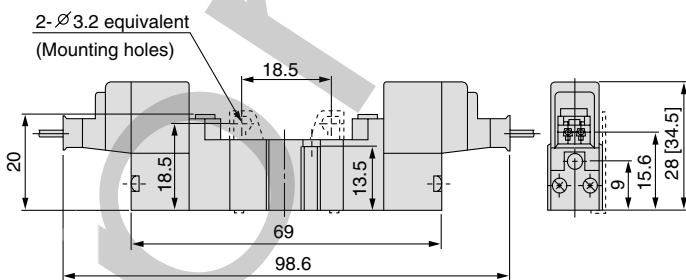
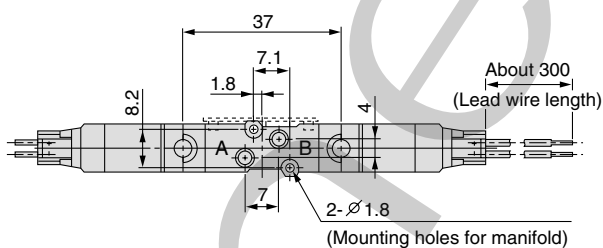

M type plug connector (M) : SYJ3220-M-M3

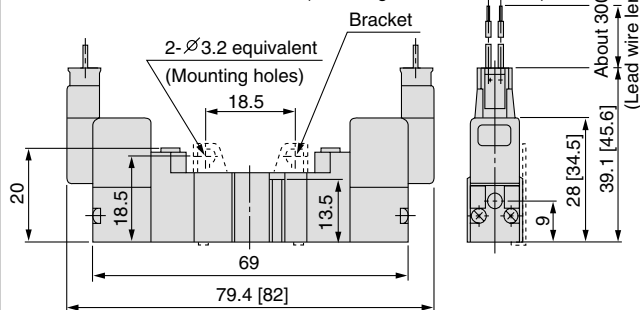
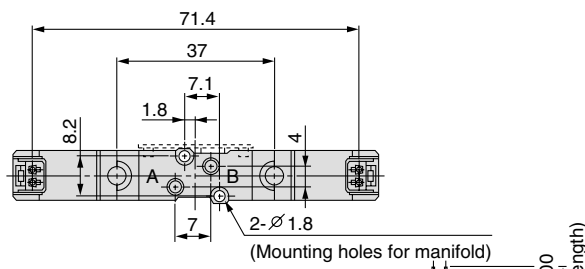

*[] for AC

*Other dimensions are the same as the grommet type.

*[] for AC

*Other dimensions are the same as the grommet type.

Valve Drawings

Series SYJ3000

3 Position Closed Center / Exhaust Center / Pressure Center

(mm)

Grommet (G), (H) : SYJ3³/₅20-□^G□□-M3

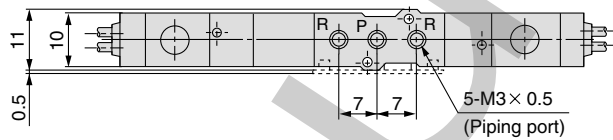
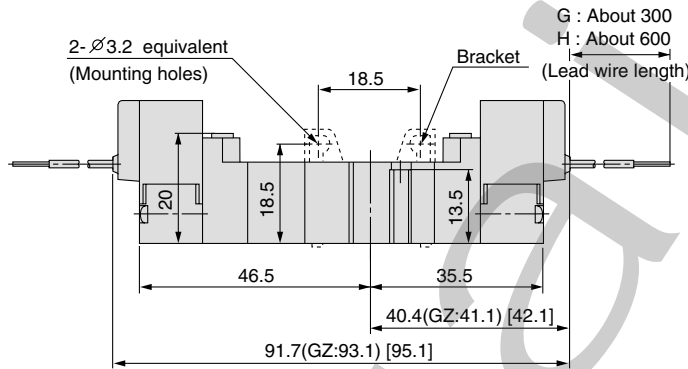
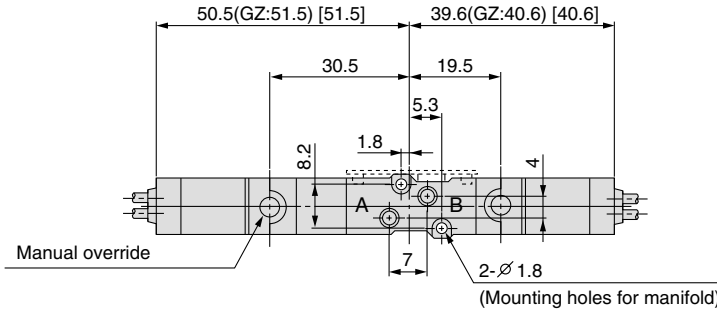

* [] for AC

L type plug connector (L) : SYJ3³/₅20-□L□□-M3

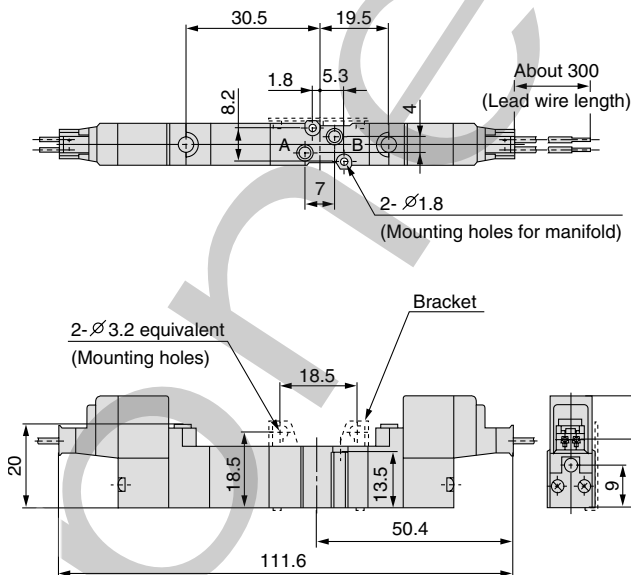

* [] for AC
* Other dimensions are the same as the grommet type.

M type plug connector (M) : SYJ3³/₅20-□M□□-M3

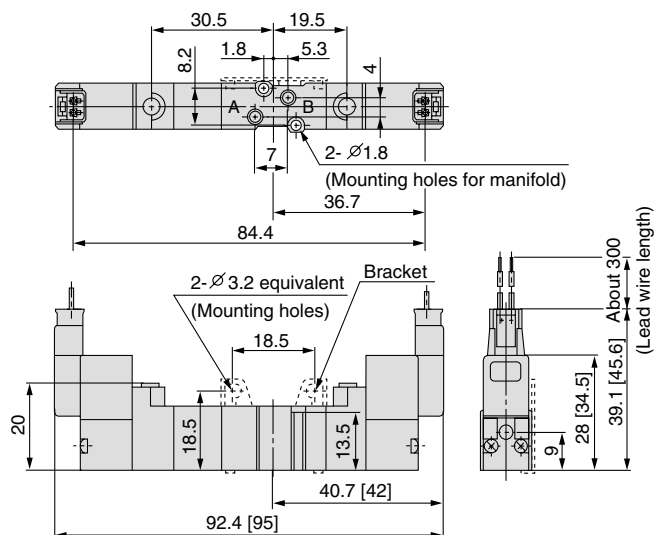

* [] for AC
* Other dimensions are the same as the grommet type.

Series SYJ3000

Valve Drawings

2 Position Single

(mm)

Grommet (G), (H) : SYJ3140-□_G□□-M5

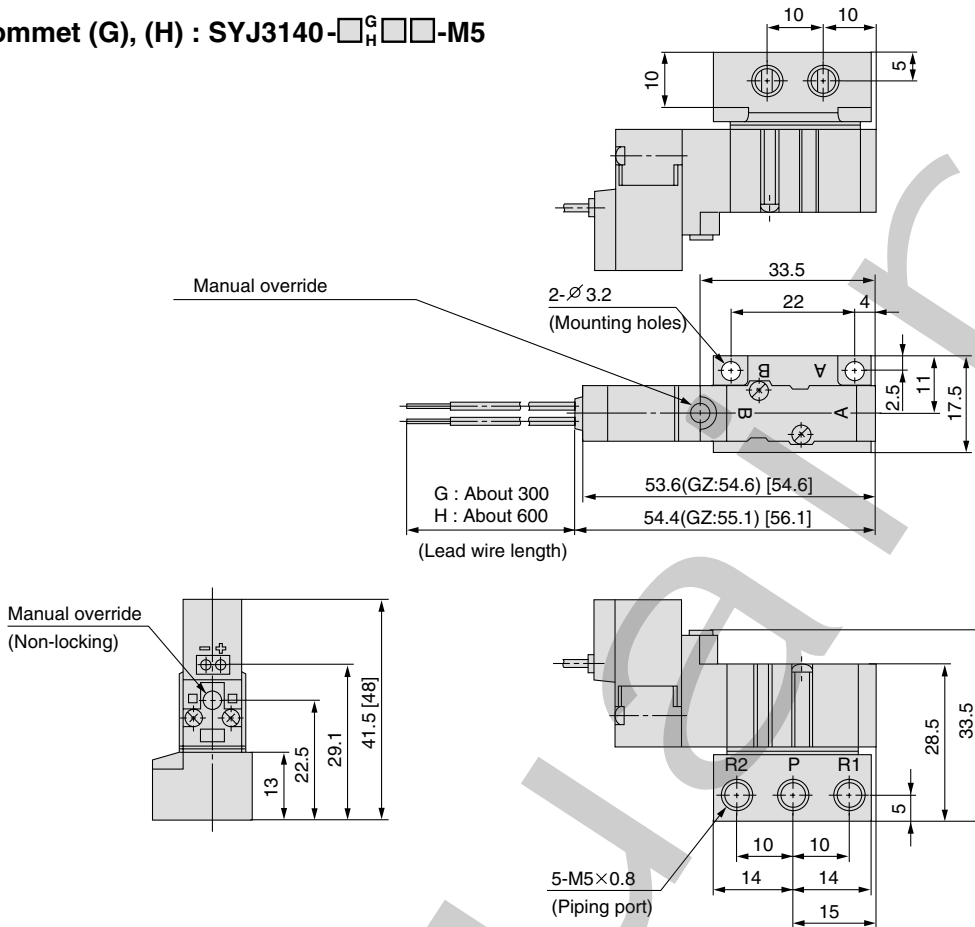

*[] for AC

L type plug connector (L) : SYJ3140-□L□□-M5

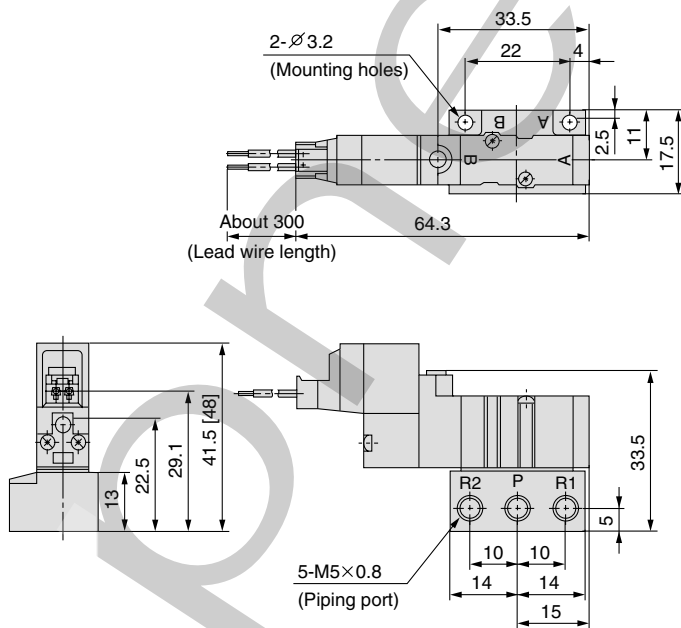

*[] for AC

*Other dimensions are the same as the grommet type.

M type plug connector (M) : SYJ3140-□M□□-M5

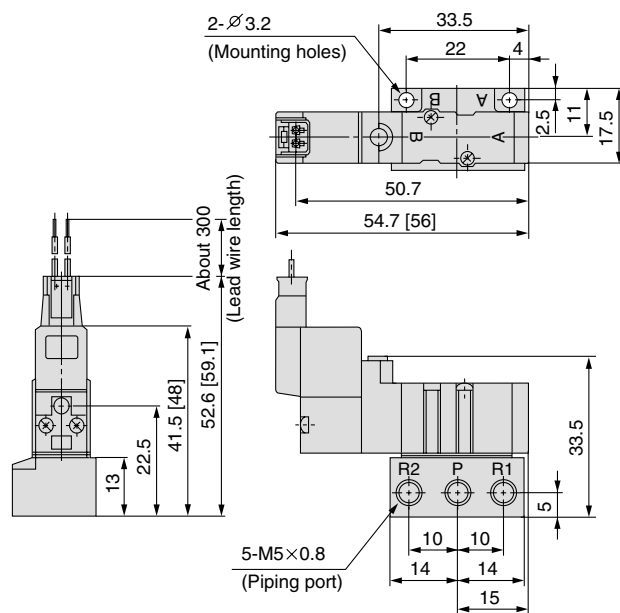

*[] for AC

* Other dimensions are the same as the grommet type.

Valve Drawings

Series SYJ3000

2 Position Double

(mm)

Grommet (G), (H) : SYJ3240-□_G□_H□□-M5

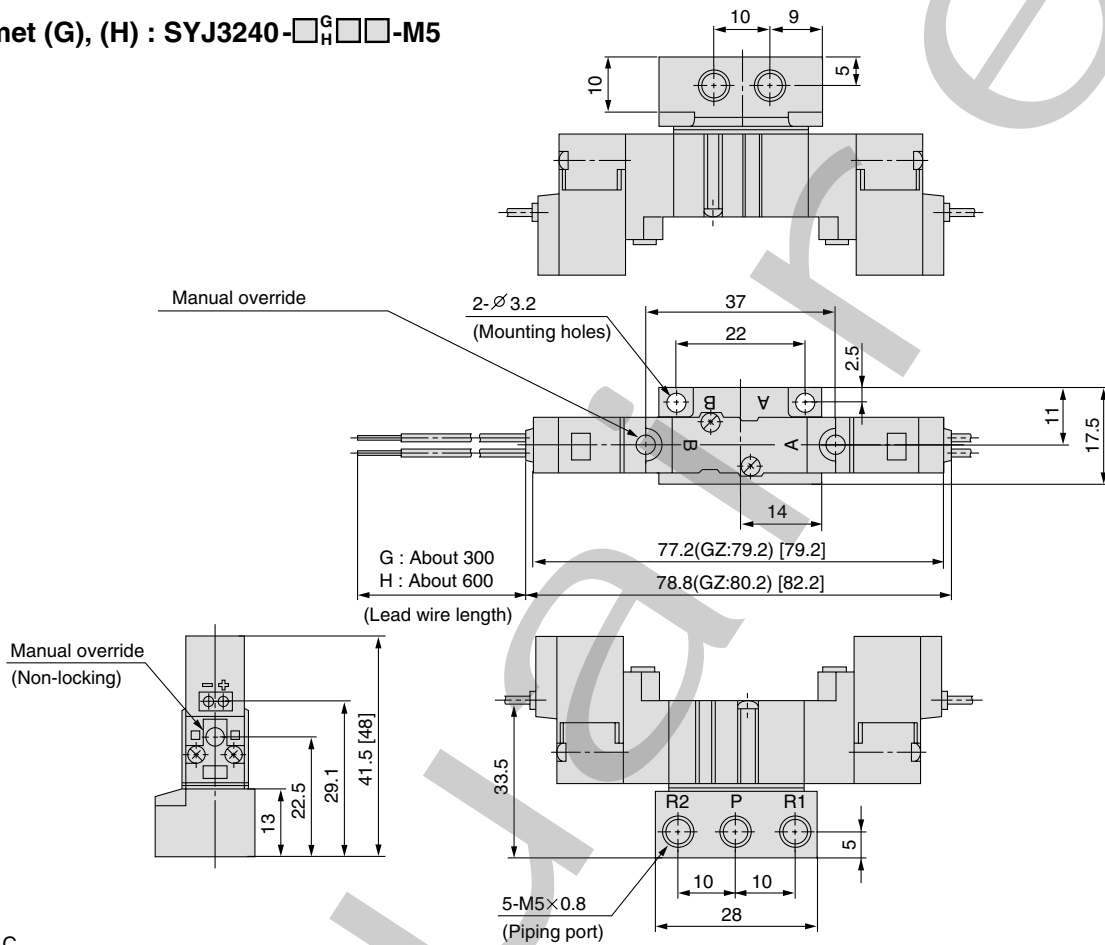

* [] for AC

L type plug connector (L) : SYJ3240-□L□□-M5

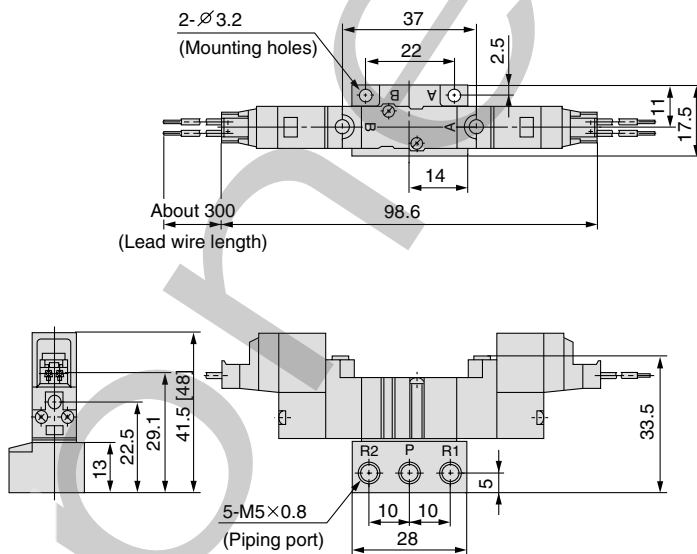

* [] for AC

* Other dimensions are the same as the grommet type.

M type plug connector (M) : SYJ3240-□M□□-M5

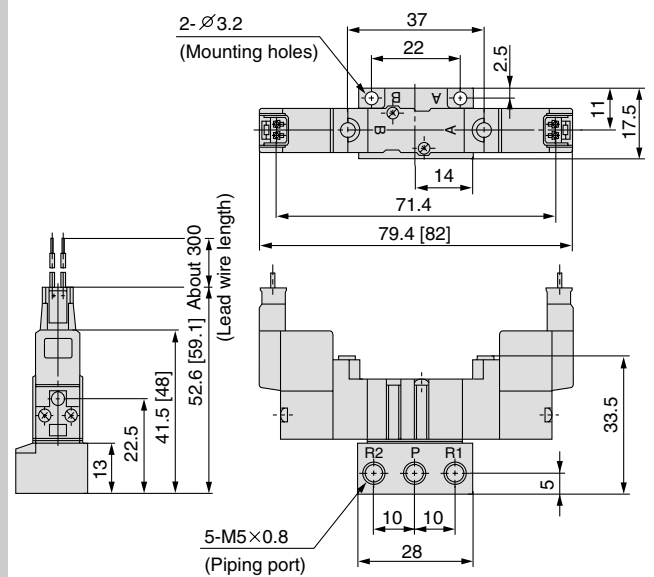

* [] for AC

* Other dimensions are the same as the grommet type.

Series SYJ3000

Valve Drawings

3 Position Closed Center / Exhaust Center / Pressure Center

(mm)

Grommet (G), (H) : SYJ3³/₄40-□_G□□-M5

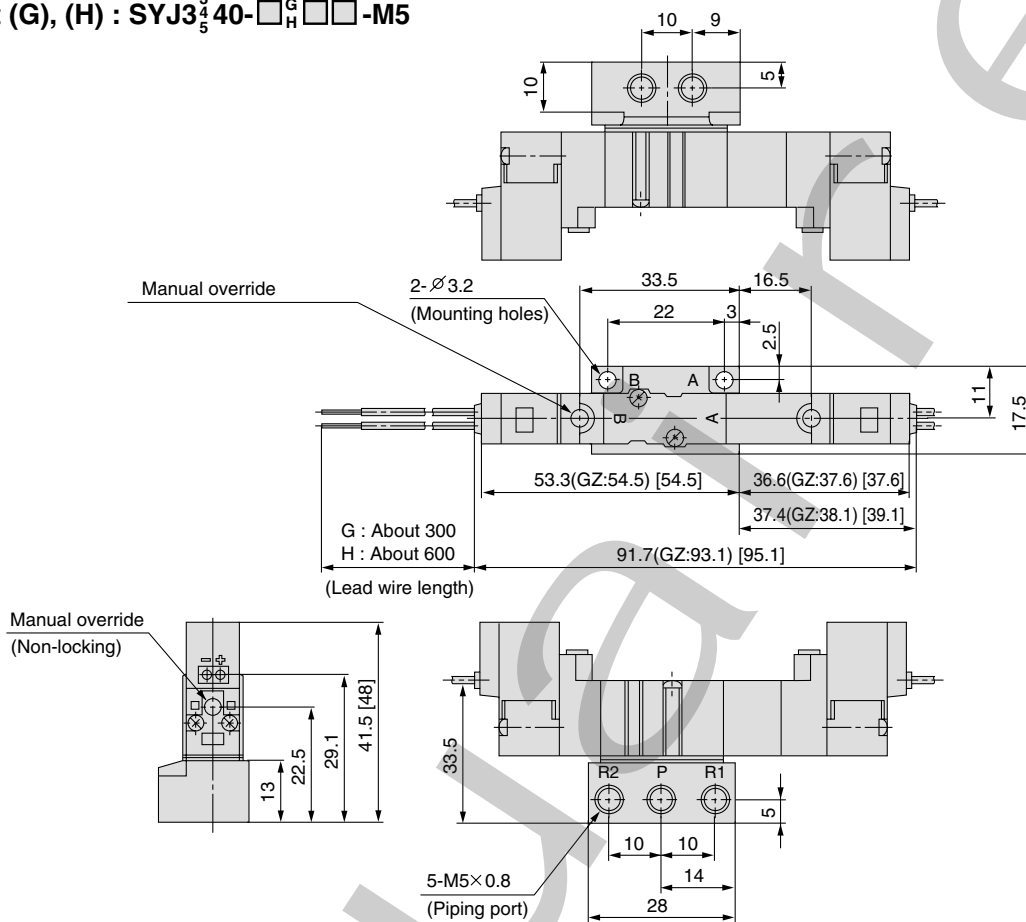

* [] for AC

L type plug connector (L) : SYJ3³/₄40-□L□□-M5

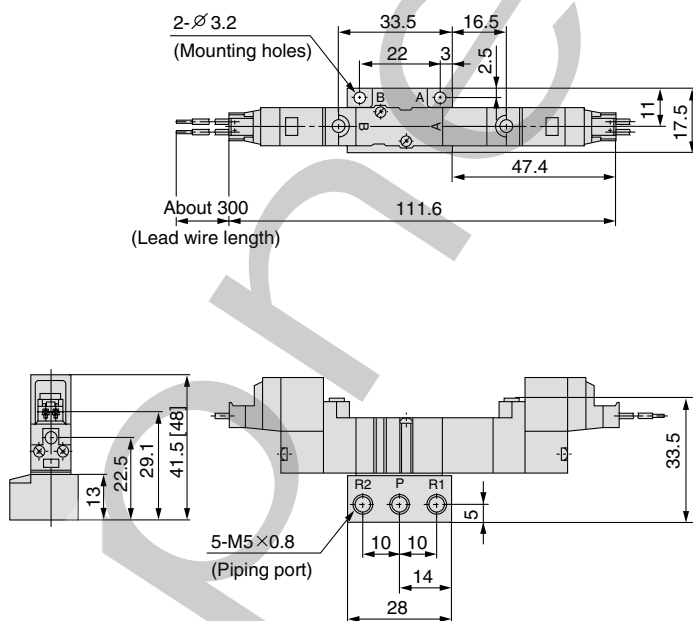

* [] for AC

* Other dimensions are the same as the grommet type.

M type plug connector (M) : SYJ3³/₄40-□M□□-M5

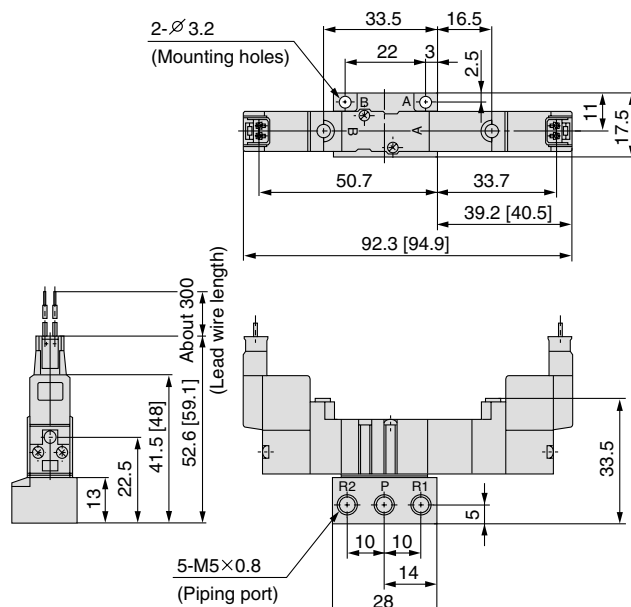

* [] for AC

* Other dimensions are the same as the grommet type.

Manifold Drawings

Series SYJ3000

Type 20 Manifold: Top Ported / SS5YJ3-20-Station

(mm)

Grommet (G), (H)

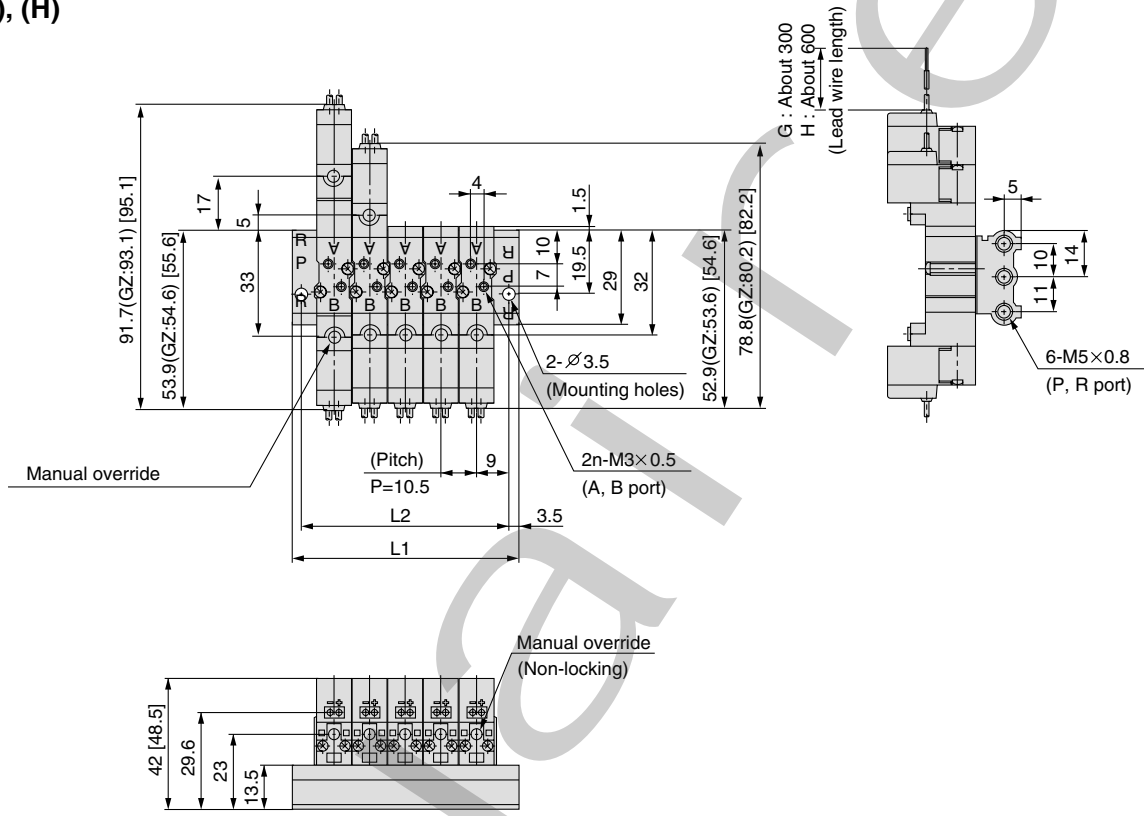

* [] for AC

L type plug connector (L)

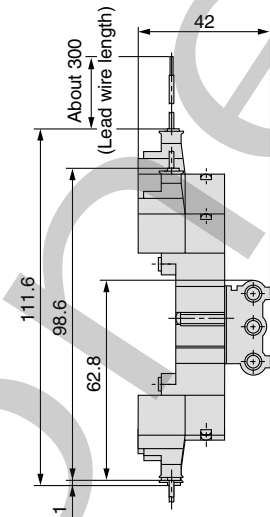

M type plug connector (M)

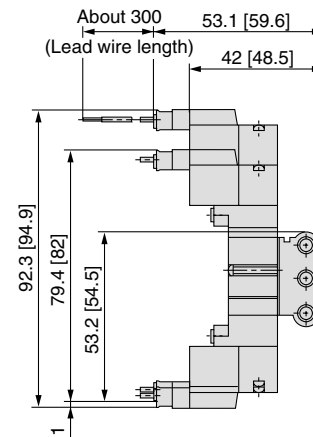

* [] for AC

* Other dimensions are the same as the grommet type.

* Other dimensions are the same as the grommet type.

Stations	2	3	4	5	6	7	8	9	10	11	12	13	14	15	16	17	18	19	20
L1	35.5	46	56.5	67	77.5	88	98.5	109	119.5	130	140.5	151	161.5	172	182.5	193	203.5	214	224.5
L2	28.5	39	49.5	60	70.5	81	91.5	102	112.5	123	133.5	144	154.5	165	175.5	186	196.5	207	217.5

Series SYJ3000

Manifold Drawings

Type 31 Manifold: Side Ported / SS5YJ3-31 - Station - M3

(mm)

Grommet (G) , (H)

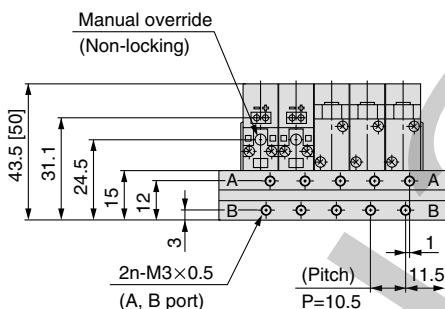
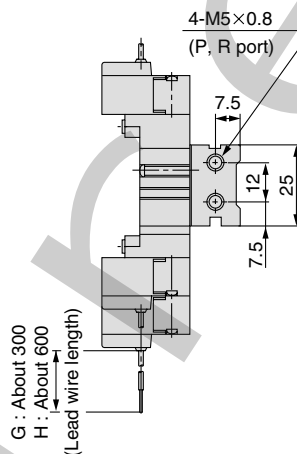
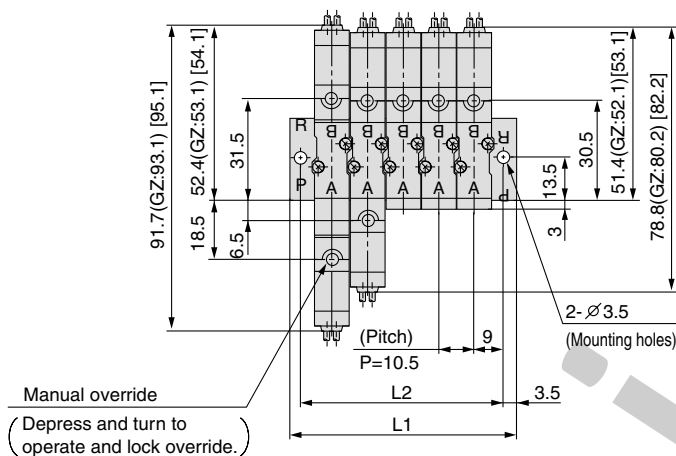

Type S31 / Side Ported

(Single solenoid coil is located on same side as the A, B port.)

SS5YJ3-S31 - Station - M3

* [] for AC

L type plug connector (L)

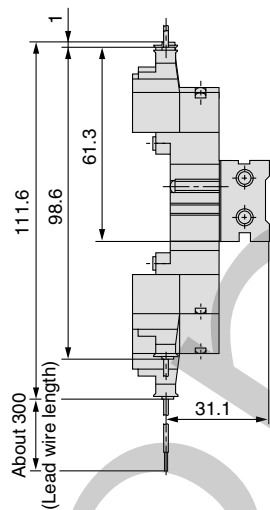

* Other dimensions are the same as the grommet type.

M type plug connector (M)

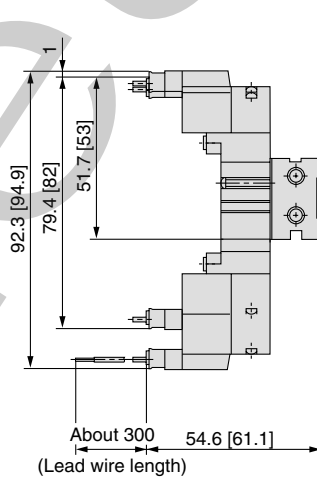

* [] for AC
* Other dimensions are the same as the grommet type.

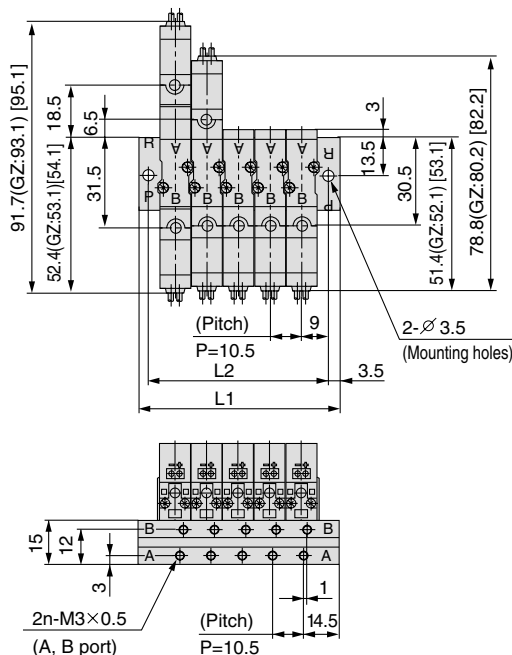

* [] for AC
* Other dimensions are the same as type 31.

Stations	2	3	4	5	6	7	8	9	10	11	12	13	14	15	16	17	18	19	20
L ₁	35.5	46	56.5	67	77.5	88	98.5	109	119.5	130	140.5	151	161.5	172	182.5	193	203.5	214	224.5
L ₂	28.5	39	49.5	60	70.5	81	91.5	102	112.5	123	133.5	144	154.5	165	175.5	186	196.5	207	217.5

Manifold Drawings

Series SYJ3000

Type 32 Manifold: Side Ported (External Pilot Type) / SS5YJ3-32- Station -M5T, N3T

(mm)

Grommet (G), (H)

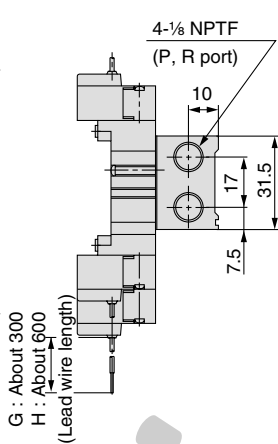
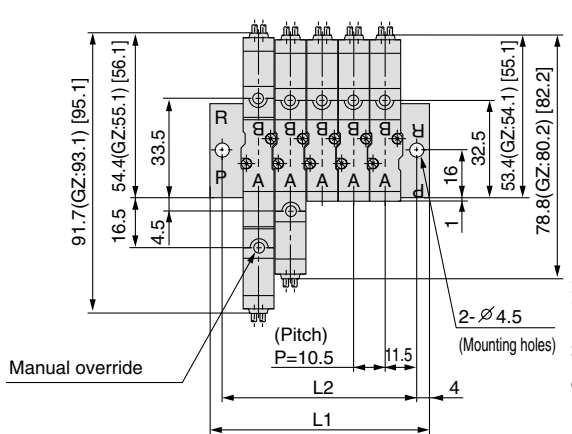

N3T(Built-in One-touch fitting)

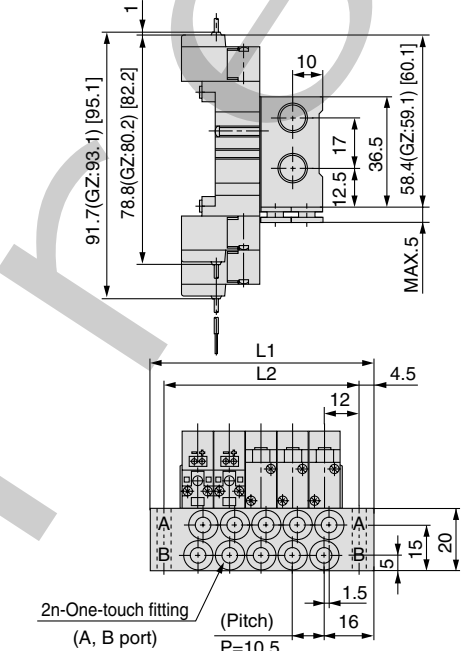

* [] for AC
* Other dimensions are the same as the M5.

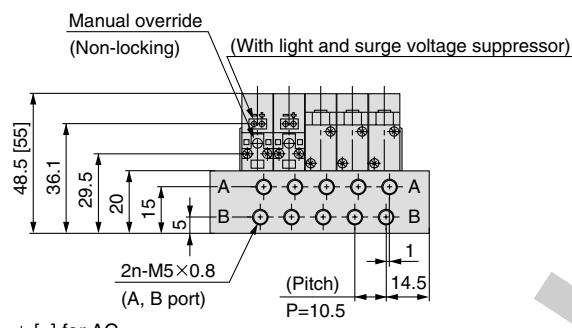

* [] for AC

Type S32 / Side Ported

(Single solenoid coil is located on same side as the A, B port.)

SS5YJ3-S32- Station -M5T, N3T

L type plug connector (L)

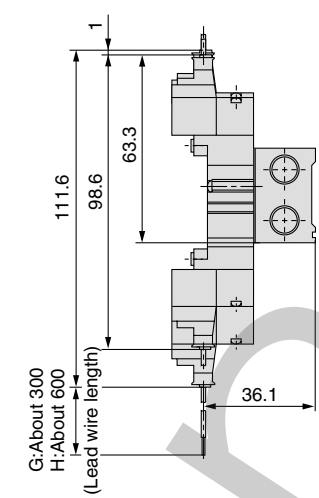

* Other dimensions are the same as the grommet type.

M type plug connector (M)

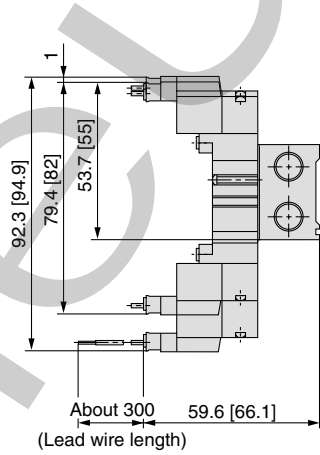

* [] for AC
* Other dimensions are the same as the grommet type.

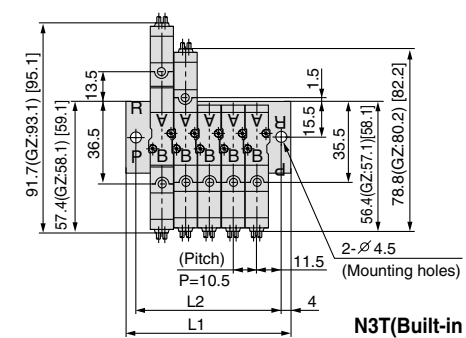

N3T(Built-in one-touch fitting)

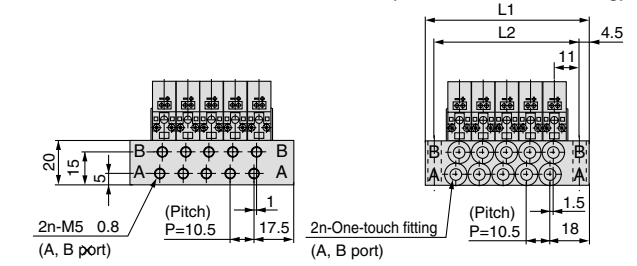

* [] for AC
* Other dimensions are the same as type 32.

SS5YJ3-32,S32- Station -M5T

Stations	2	3	4	5	6	7	8	9	10	11	12	13	14	15	16	17	18	19	20
L1	41.5	52	62.5	73	83.5	94	104.5	115	125.5	136	146.5	157	167.5	178	188.5	199	209.5	220	230.5
L2	33.5	44	54.5	65	75.5	86	96.5	107	117.5	128	138.5	149	159.5	170	180.5	191	201.5	212	222.5

SS5YJ3-32,S32- Station -N3T

Stations	2	3	4	5	6	7	8	9	10	11	12	13	14	15	16	17	18	19	20
L1	42.5	53	63.5	74	84.5	95	105.5	116	126.5	137	147.5	158	168.5	179	189.5	200	210.5	221	231.5
L2	33.5	44	54.5	65	75.5	86	96.5	107	117.5	128	138.5	149	159.5	170	180.5	191	201.5	212	222.5

Series SYJ3000

Manifold Drawings

Type 41 Manifold: Side Ported/SS5YJ3-41-Station - M5T, N3T

(mm)

Grommet (G), (H)

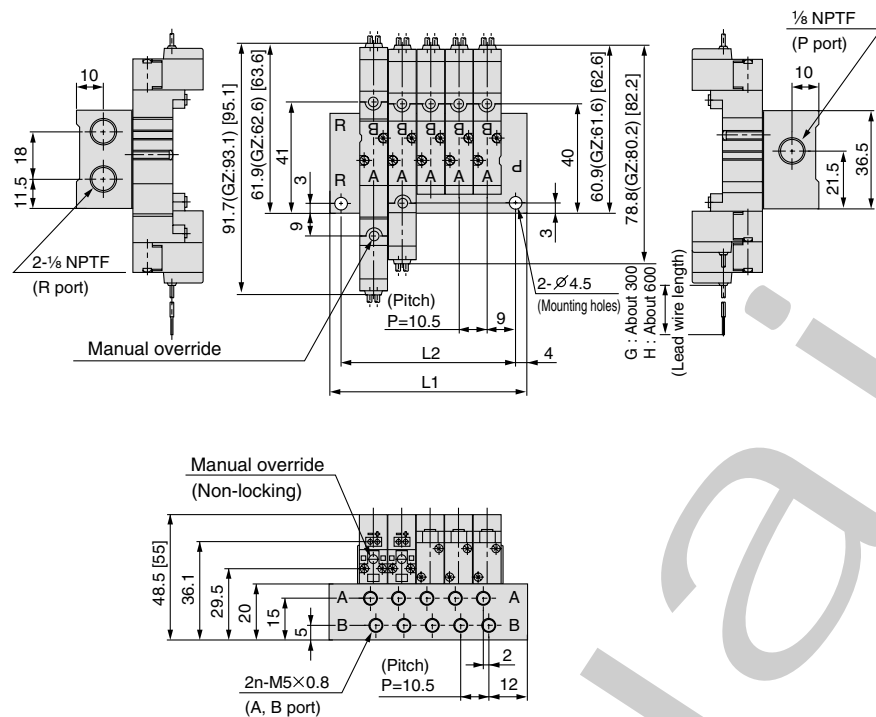

N3T(Built-in One-touch fitting)

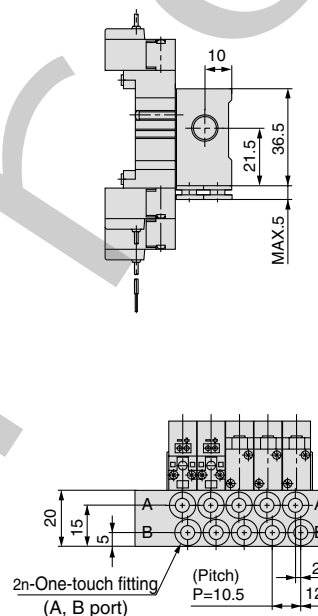

* Other dimensions are the same as the M5T.

* [] for AC

L type plug connector (L)

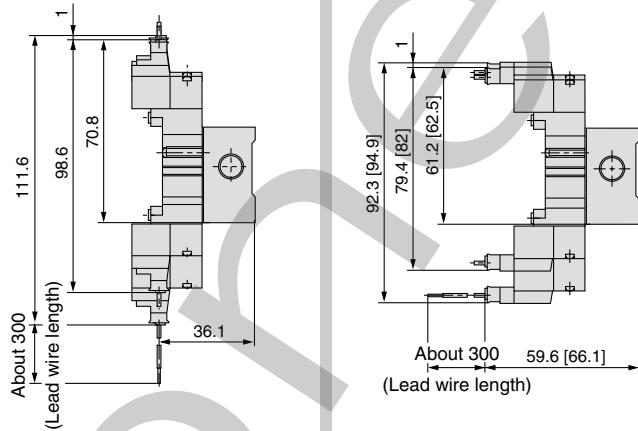

* Other dimensions are the same as the grommet type.

M type plug connector (M)

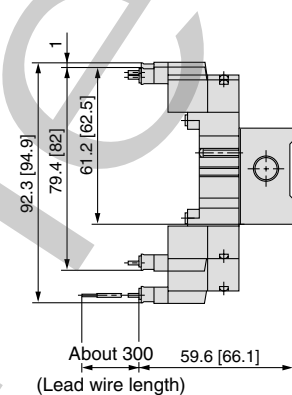

* [] for AC
* Other dimensions are the same as the grommet type.

Type S41 / Side Ported

(Single solenoid coil is located on same side as the A, B port.)

SS5YJ3-S41-Station -M5,N3T

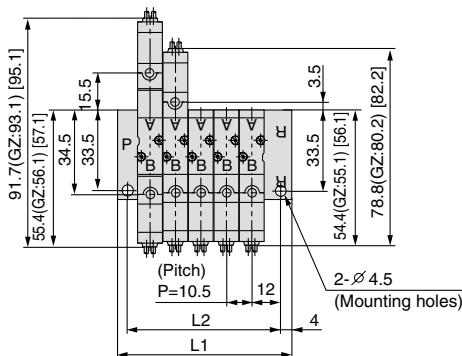

N3T(Built-in one-touch fitting)

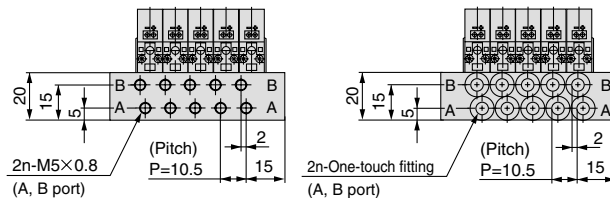

* [] for AC
* Other dimensions are the same as type 41.

Stations	2	3	4	5	6	7	8	9	10	11	12	13	14	15	16	17	18	19	20
L ₁	39.5	50	60.5	71	81.5	92	102.5	113	123.5	134	144.5	155	165.5	176	186.5	197	207.5	218	228.5
L ₂	31.5	42	52.5	63	73.5	84	94.5	105	115.5	126	136.5	147	157.5	168	178.5	189	199.5	210	220.5

Manifold Drawings

Series SYJ3000

Type 46 Manifold: Side Ported / SS5YJ3-46-Station-M5T, N3T

(mm)

Grommet (G) , (H)

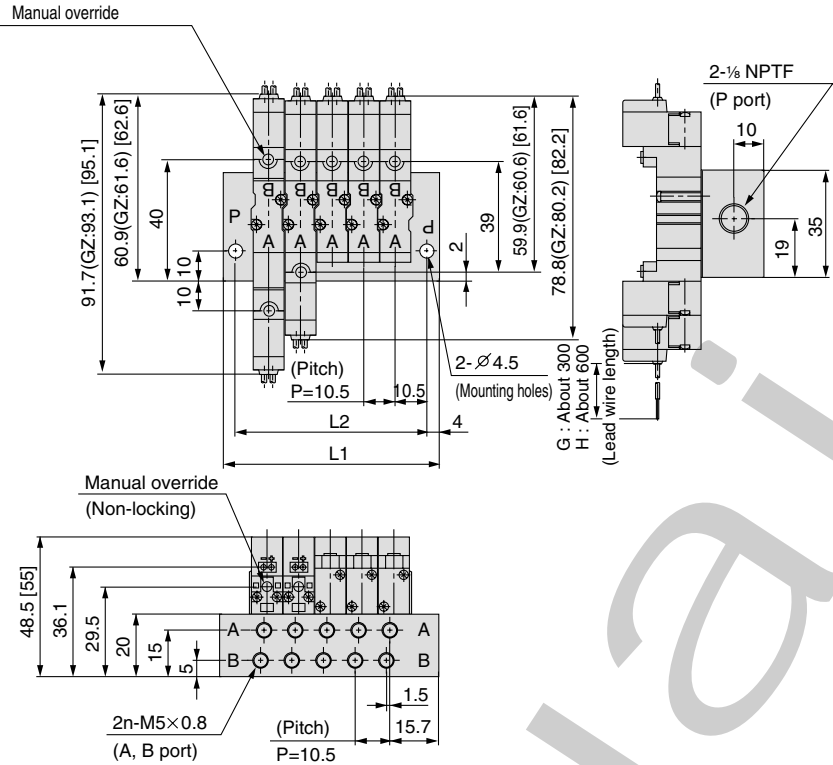

N3T(Built-in One-touch fitting)

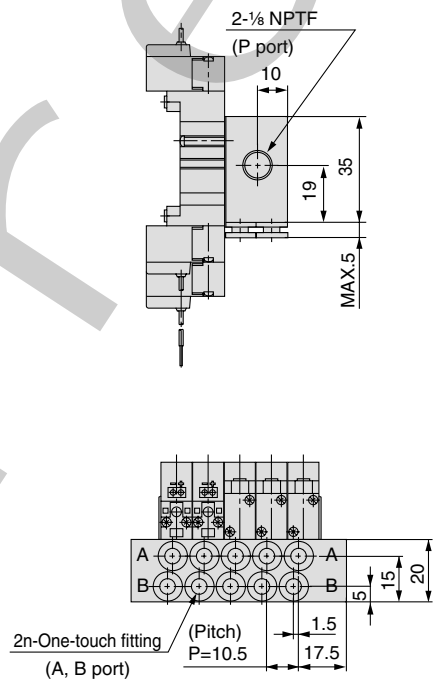

*Other dimensions are the same as the M5T.

* [] for AC

Type S46 / Side Ported

(Single solenoid coil is located on same side as the A, B port.)

L type plug connector (L)

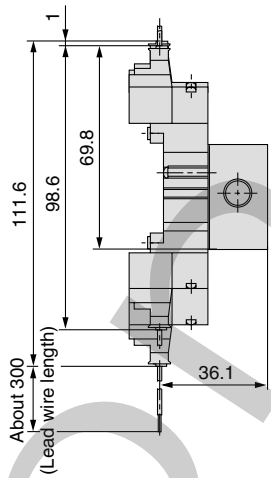

M type plug connector (M)

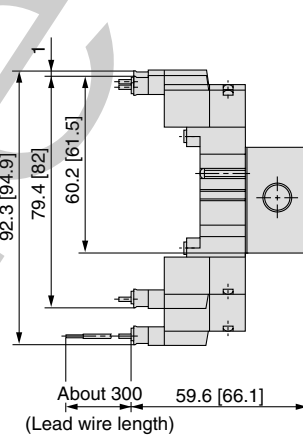

* [] for AC

* Other dimensions are the same as the grommet type.

SS5YJ3-S46-Station-M5T, N3T

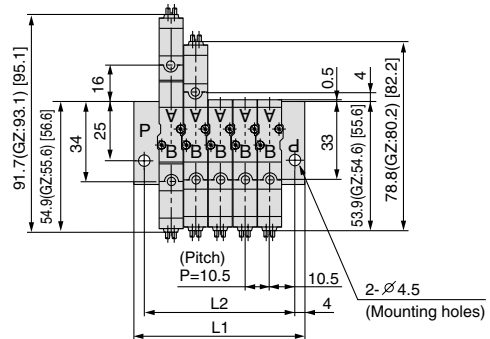

N3T(Built-in One-touch fitting)

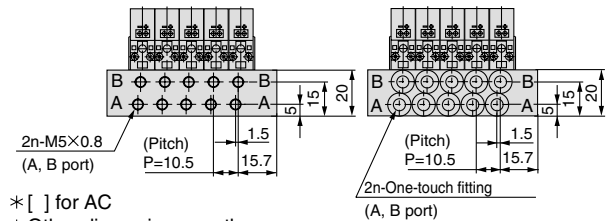

* [] for AC

* Other dimensions are the same as type 46.

* Other dimensions are the same as the grommet type.

Stations	2	3	4	5	6	7	8	9	10	11	12	13	14	15	16	17	18	19	20
L ₁	39.5	50	60.5	71	81.5	92	102.5	113	123.5	134	144.5	155	165.5	176	186.5	197	207.5	218	228.5
L ₂	31.5	42	52.5	63	73.5	84	94.5	105	115.5	126	136.5	147	157.5	168	178.5	189	199.5	210	220.5

Series SYJ3000

Manifold Drawings

Flat Cable Manifold

(mm)

SS5YJ3-21P-Station - 00T

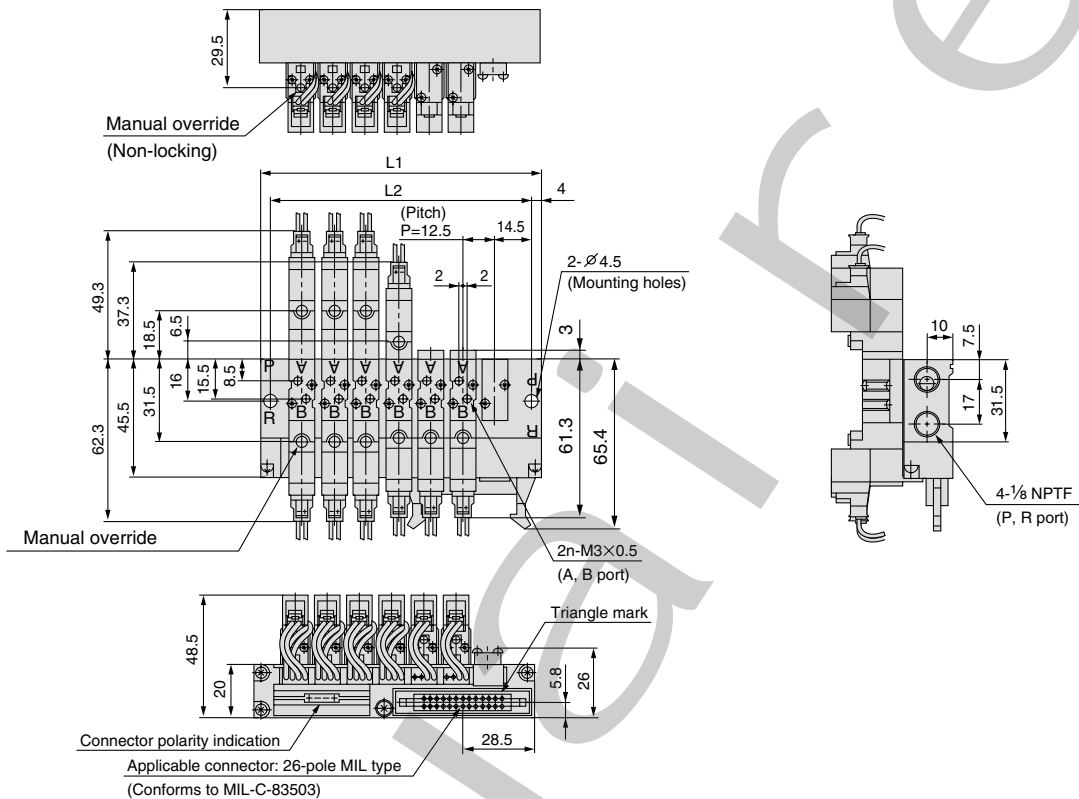

SS5YJ3-32P-□□-M5T, N3T

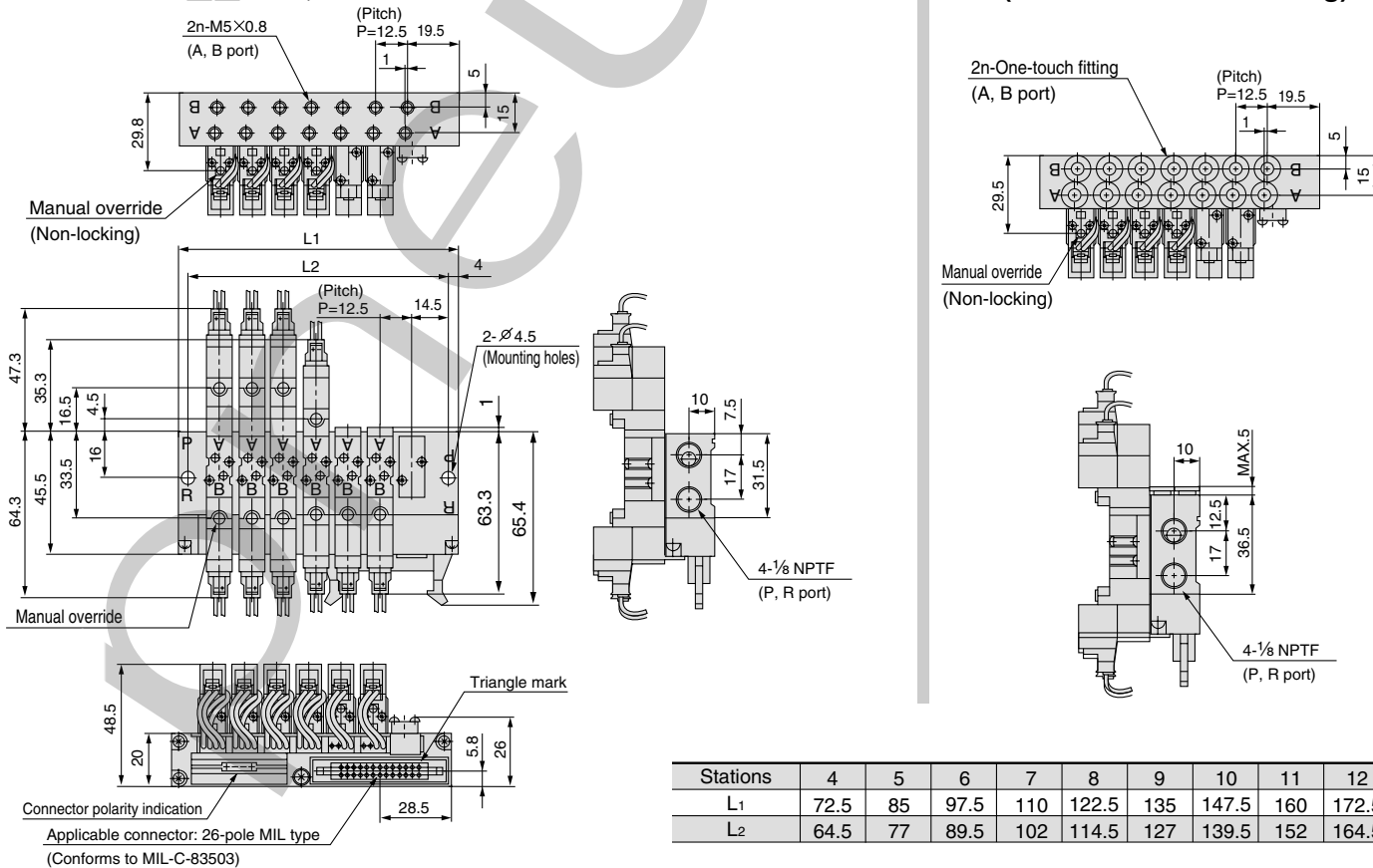

N3T(Built-in One-touch fitting)

Stations	4	5	6	7	8	9	10	11	12
L1	72.5	85	97.5	110	122.5	135	147.5	160	172.5
L2	64.5	77	89.5	102	114.5	127	139.5	152	164.5

Operations Guide

Series SYJ3000

■	System Design	36
■	Installation	37
■	Maintenance	38
■	Manual Override	39
■	Surge Suppressor	40
■	Wiring	41
■	Mixed Mounting of 3 & 4 Way Valves	42

Precautions

- ① The compatibility of pneumatic equipment is the responsibility of the person who designs the pneumatic system or decides its specifications.**

Since the products specified here are used in various operating conditions, their compatibility for the specific pneumatic system must be based on specifications or after analysis and/or tests to meet your specific requirements.

- ② Only trained personnel should operate pneumatically operated machinery and equipment.**

Compressed air can be dangerous if an operator is unfamiliar with it. Assembly, handling or repair of pneumatic systems should be performed by trained and experienced operators.

- ③ Do not service machinery/equipment or attempt to remove component until safety is confirmed.**

1. Inspection and maintenance of machinery/equipment should only be performed after confirmation of safe locked-out control positions.

2. When equipment is to be removed, confirm the safety process as mentioned above. Cut the supply pressure for this equipment and exhaust all residual compressed air in the system.

3. Before machinery/equipment is re-started, take measures to prevent actuation of cylinder piston rod, etc. (Bleed air into the system gradually to create back-pressure.)

- ④ Contact P/A if the product is to be used in any of the following conditions:**

1. Conditions and environments beyond the given specifications, or if product is used outdoors.

2. Installation on equipment in conjunction with atomic energy, railway, air navigation, vehicles, medical equipment, food and beverage, recreation equipment, emergency stop circuits, press applications, or safety equipment.

3. An application which has the possibility of having negative effects on people, property, or animals, requiring special safety analysis.

System Design Precautions

1 Operation of actuator

When an actuator, e.g. cylinder, is to be operated using a valve, take appropriate measures to prevent potential injuries to personnel caused by the actuator movement.

2 Stopping the cylinder in a midstroke position.

Using a 3 position closed center valve to hold a cylinder in a midstroke position is not recommended. Accurate stopping of the piston in a predetermined position is not possible due to the compressibility of air. Internal valve and cylinder leakage will cause the piston to drift if a midstroke position is held for any length of time. If midstroke positioning is required, please contact P/A.

3 Effect of back pressure when using manifold

Possible malfunction due to back-pressure may result when valves are used on a manifold. If this problem occurs take appropriate countermeasures.

4 Holding pressure (including vacuum)

Since the valve may have slight internal air leakage, it may not be suitable for holding pressure (including vacuum) in a tank or other vessel for an extended period of time.

5 Not suitable for use as an emergency shutoff valve

The valve represented in this catalog is not intended for use as an emergency shutoff valve. If the valve is used in this type of system, other positive shutoff components should be used in conjunction.

6 Maintenance space

Installation should consider that enough space is provided for maintenance (removal of valve, etc.).

7 Release of residual pressure

Install a method for the release of residual pressure for maintenance purpose.

8 Using in vacuum condition

When valve is used for switching vacuum, take precautions for the suction of external dust or other contaminants that may lead to valve malfunction.

Selection

1 Confirm specifications

Product represented in this catalog is designed only for use in compressed air systems (including vacuum). Do not use with pressure or temperature beyond the specification range. Contact P/A when using a fluid other than compressed air (including vacuum).

2 Long period of continuous energization

Contact P/A when the valve is to be continuously energized for a long period.

3 Energization time

The double solenoid valve must be energized for at least 0.05 second to ensure proper operation.

4 Leakage Voltage

When a C-R device (Surge voltage suppressor) is used for the protection of switching device, note that leakage voltage will increase due to the C-R device.

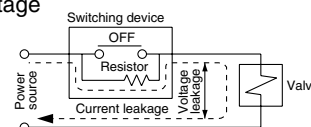

Suppress residual leakage voltage as follows :

DC coil : 3% or less of rated voltage

AC coil : 8% or less of rated voltage

Use in low temperature environment

5 Valve use is possible to extreme of -10°C . Take appropriate measures to avoid freezing of drain, moisture etc. by use of an air dryer.

Mounting orientation

6 Mounting position is free. No specific orientation is necessary.

Installation

1 If air leakage is increasing or equipment is not properly operating, discontinue use of the valve and inspect the cause.

Check mounting conditions after air and power supplies are connected. Initial function and leakage tests should be performed after installation.

2 Install only after reading and understanding the safety instructions.

Keep the catalog on file so that it can be referred to when necessary.

3 Coating

Warnings or specifications indicated on the product should not be erased, removed, or covered up. If paint is applied to resinous parts it may have an adverse effect due to paint solvent.

Piping

1 Before piping

Make sure that chips, cutting oil, dust etc., in contact with piping are removed (flushing) before installation.

2 Sealant tape

When installing piping or fittings into a port, ensure that sealant material does not enter the port internally.

When using sealing tape, leave 1.5 to 2 threads exposed on the end of pipe/fitting.

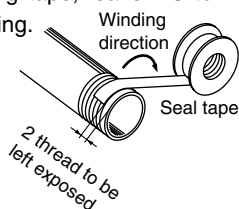

3 Precautions for closed center valves:

When using a closed center or perfect spacer type, make sure that there are no air leaks in the piping between the valve and the cylinder.

4 Tightening torques

When installing fitting, etc., follow the given torque levels below.

Tightening torque

Thread	Appropriate tightening torque inch-lbs. (kgf-cm)
M3	0.78 (3 to 5)
M5	13 to 17.3 (15 to 20)
Rc(PT)1/8	61 to 78 (70 to 90)
Rc(PT)1/4	104 to 121 (120 to 140)

5 Piping to product

When installing piping to a product, refer to operation manual to avoid mistakes.

Wiring

1 Polarity

When DC power is connected to a solenoid valve equipped with light and/or surge voltage suppressor, check for polarity indications.

No diode to protect polarity :

If polarity connection is wrong, the diode in the valve or switching device at control equipment or power supply may be damaged.

With diode to protect polarity :

If polarity connection is wrong, the valve does not switch.

Applied voltage

- 2 When electricity is applied to the solenoid valve, be careful to apply the proper voltage. Improper voltage may cause malfunction or coil damage.

Connection

- 3 Make sure connections are tight after wiring.

Lubrication

1 Lubrication

- 1 The valve has been lubricated for life at manufacture, and does not require lubrication in service.
- 2 If a lubricant is used in the system, use turbine oil Class 1, ISO VG32 (no additives). Once lubricant is used in the system, you must continue to lubricate as the original lubricant applied during manufacturing will be washed away. Contact P/A for recommended turbine oil Class 2, ISO VG32 (with additives).

Supply Air

1 Use clean air

If the compressed air supply includes chemicals, synthetic materials (including organic solvents), salinity, corrosive gas, etc., it can lead to damage or malfunction.

2 Install an air filter

Install an air filter at the upper stream side of the valve. Filtration degree should be 5 μ m or less.

3 Install an air dryer, after cooler, etc..

Air that includes excessive condensate may cause malfunction of valve and other pneumatic equipment. To prevent this, install an air dryer, after cooler etc..

4 If excessive carbon powder is present in the line, install a mist separator on the upstream side of the valve.

Refer to "Air Cleaning Equipment" catalog for compressed air quality.

Environment

- ❶ Do not use in an environment where the valve is in direct contact with corrosive gases, chemicals, salt water, water or steam.
- ❷ Do not use in an explosive environment.
- ❸ Do not use in locations subject to heavy vibration and/or shock. Check the specifications for each series.
- ❹ The valve should not be exposed to prolonged sun light. Use a protective cover.
- ❺ Remove emissive heat.
- ❻ If using in an environment where there is possible contact with water drop-lets, oil, weld spatter, etc., take suitable protectionary measures.
- ❼ When the solenoid valve is mounted in a control panel or its energizing time is long, make sure ambient temperature is within valve specification range.

Maintenance

- ❶ **Maintenance procedures are shown in operation manual.**
If handled incorrectly, it may cause malfunction and damage to machine or equipment.
- ❷ **Machine maintenance and supply/exhaust of compressed air**
When machine is to be serviced, first check for removal of workpieces and run-away of equipment, etc. Then cut the supply pressure and power and exhaust all compressed air from the system. (Lock-out valve for release of residual pressure is recommended) When the machine is to be restarted, check first that actuators are in their proper start up positions.
- ❸ **Low frequency operation**
Valve should be switched at least once every 30 days to avoid malfunction.
- ❹ **Manual override**
When manual override is engaged, connected equipment starts to operate. Be sure of safety.
- ❺ **Drain**
Remove condensate from air filter regularly.
- ❻ **Lubrication**
If a lubricant for rubber seal type valve is introduced, continue to lubricate and use turbine oil Class 1, VG32 (no additives). If other lubricant oil is used, it may cause malfunction. Contact P/A for suggested turbine oil Class 2, VG32 (with additives).

How to Calculate Flow Rate (At an air temperature 68°F)

Subsonic flow : $P_1 + 0.1013 < 1.89(P_2 + 0.1013)$

$$Q = 226S \sqrt{\Delta P(P_2 + 0.1013)}$$

Sonic flow : $P_1 + 0.1013 \geq 1.89(P_2 + 0.1013)$

$$Q = 113S(P_1 + 0.1013)$$

Q : Flow rate [ℓ /min(ANR)]

S : Effective area (mm²)

ΔP : Differential pressure (P₁-P₂) [MPa]

P₁ : Upstream pressure [MPa]

P₂ : Downstream pressure [MPa]

* When the air temperature is different, multiply the flow rate calculated with the above formula by the following coefficient for compensation.

Air temperature (°F)	-4	14	32	50	86	104	122	140
Coefficient for compensation	1.08	1.06	1.04	1.02	0.98	0.97	0.95	0.94

Operation of Manual Override

Use caution since manual override operation will operate any connected actuators.

■ Non-locking push type [Standard type]

Press in the direction of the arrow.

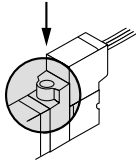

■ Push-locking slotted type [D]

While pressing, turn in the direction of the arrow. If you do not turn, the mechanism does not lock in position.

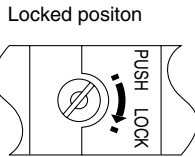
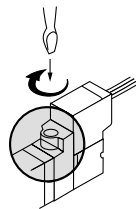

Note) A second manual override is located on the pilot valve assembly. It is only available as a non-locking push type. Simply depress in the direction of the arrow shown to operate.

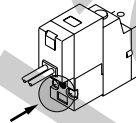

Common Exhaust Port for the Pilot and Main Valve

Pilot air is exhausted through the main valve body rather than directly to atmosphere.

- Suitable for applications where exhausting the pilot valve to atmosphere would be detrimental to the surrounding working environment.
- For use in extremely dirty environments where there is the possibility that dust could enter the pilot exhaust and damage the valve. Ensure that the piping of exhaust air is not too restrictive.

Series SYJ3000 and Series SYJ300 can be mounted on the same manifold.

SYJ3000, SYJ300 P. 42

Series SYJ 3000 may be used as a N.C. or N.O 3 way valve by plugging one of the A, B ports.

Be sure not to plug the exhaust ports. Can be used when a double solenoid, 3 way valve is required.

Plug position		B port	A port
Configuration		N.C.	N.O.
Number of solenoids	Single	Plug	Plug
	Double	Plug	Plug

How to Use Plug Connector

① Insertion/Removal of Connector

- Insertion—Push the connector straight on to the pins of the solenoid, making sure the lip of the lever securely "locks" into the groove of the solenoid cover.
- Removal—Press the lever against the connector housing and pull it outward from the solenoid.

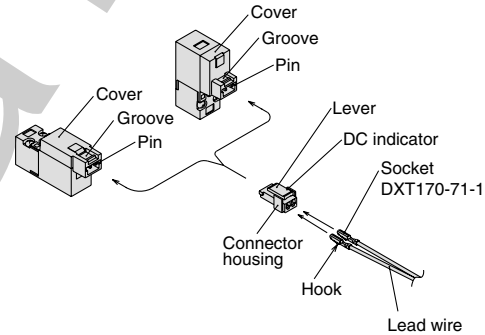

② Crimping connection of lead wire and socket

Strip 3.2 to 3.7mm of the lead wire ends, insert each stripped wire into socket and crimp contact using special crimping tool. Be careful that the outer insulation of the lead wires does not interfere with the socket contact part. (Contact P/A for special crimping tool.)

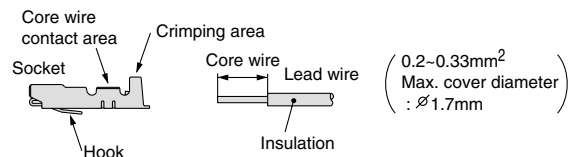

③ Connection/Disconnection of socket with lead wire

● Connection

Insert lead wire and crimped socket into square holes (indicated as A,B, COM) of connector. Press the socket in fully until the hook of the socket locks into the groove of the connector housing. Confirm the locked position by lightly pulling on the lead wire.

● Disconnection



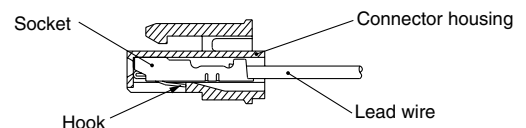

To remove the socket from the connector, pull out lead wire while depressing the hook of the socket with a fine screw driver (or similar). If the socket is to be re-used, reposition the hook again.



Plug Connector Type Lead Wire Length

Standard length is 300mm, but the following lengths are also available.

How to Order Connector Ass'y

- For DC: **SY100-30-4A** 
- For 100VAC: **SY100-30-1A** 
- For 200VAC: **SY100-30-2A** 
- For other voltages of AC: **SY100-30-3A** 

How to Order

To order a valve with lead wire length other than 300mm, indicate part numbers of the valve without connector and the required connector ass'y separately.

(Example) 2000mm lead wire length

- | | |
|----------------|----------------|
| For DC | For AC |
| SYJ3120-5LO-M3 | SYJ3120-1LO-M3 |
| SY100-30-4A-20 | SY100-30-1A-20 |

Lead wire length

—	300mm
6	600mm
10	1000mm
15	1500mm
20	2000mm
25	2500mm
30	3000mm
50	5000mm

Surge Voltage Suppressor

<For DC>
Grommet, L and M type plug connector

With surge voltage suppressor

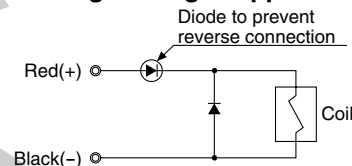

Indicator light and surge voltage suppressor (□Z)

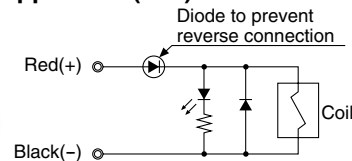

Non polarity type (□U)
<12V,24VDC only>

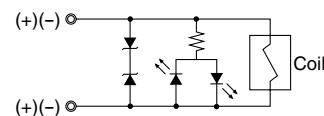

- Correctly connect the lead wires to + (positive) and - (negative) indications on the connector.
- For non-polarity type, the lead wires can be connected to either one.
- For DC voltages other than 12, 24 incorrect wiring will cause damage to the surge voltage suppressor circuit. (Wrong polarity will cause damage.)
- Solenoids, whose lead wires have been pre-wired, are positive side red and negative side black.

<For AC>

<"S" option is not available since surge voltage is automatically suppressed by the converter.>

Grommet, L and M type plug connector

With light(□Z)

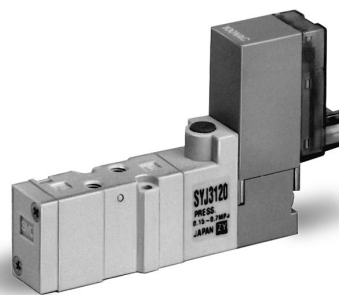
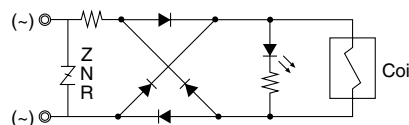

Connector Ass'y with Protective Cover

Connector ass'y with protective cover enhances dust protection.

- Effective in preventing possible short circuit problems due to contaminants in contact with connector section.
- Cover material is chloroprene rubber which has excellent weatherability and electric insulation properties. However, be careful not to allow contact with cutting oil.
- Round cord provides clean appearance.

How to Order

VJ10 - 51 - A -

• Lead wire length (L)

—	300mm
6	600mm
10	1000mm
15	1500mm
20	2000mm
25	2500mm
30	3000mm
50	5000mm

Connector Ass'y with Cover/Dimensions

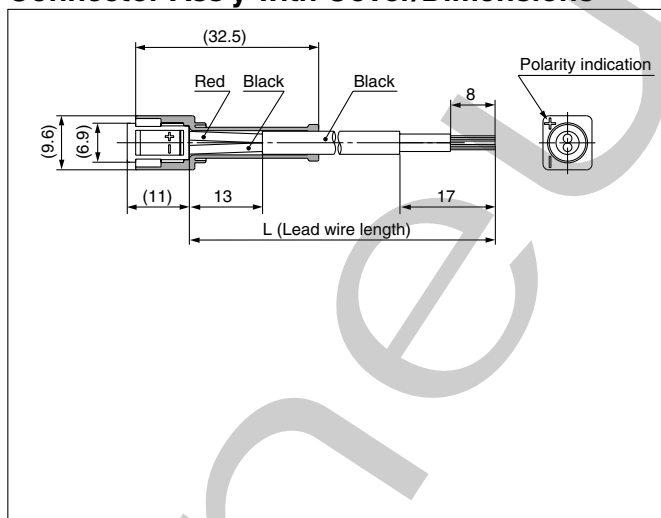

Flat Cable Manifold

Type 21P

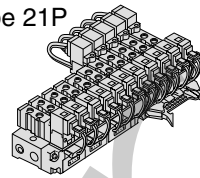

Type 32P

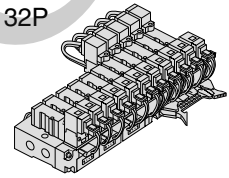

- With the flat cable manifold, each valve is wired to the manifold base. A single MIL type flat cable connects the entire manifold to the power source. This greatly reduces installation time.

Internal Wiring of Manifold

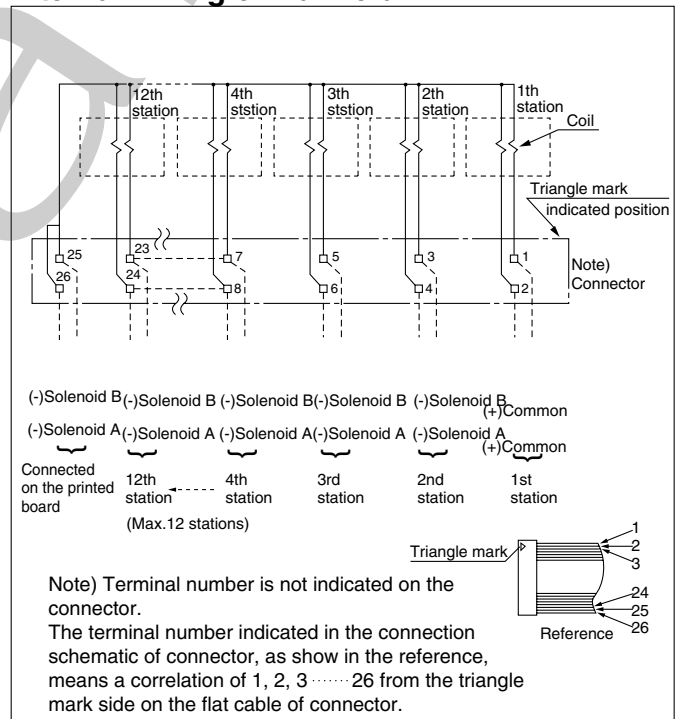

- For more than 10 stations, both poles of the common should be wired.
- For single solenoid, connect to the solenoid B side.
- The maximum number of stations is 12. If more than 12 stations are required, consult P/A.
- Only non-polar valves are available for the flat cable manifold, therefore, negative COM and positive COM wiring of the manifold is possible.

Bracket

The SYJ3000 single sol. with the factory installed foot bracket cannot be used with the bracket removed.

Difference between SYJ3□3 $\frac{3}{8}$ and SYJ3□4 $\frac{3}{8}$

**SYJ3□30,3□33
(4 Port)**

**SYJ3□40,3□43
(5 Port)**

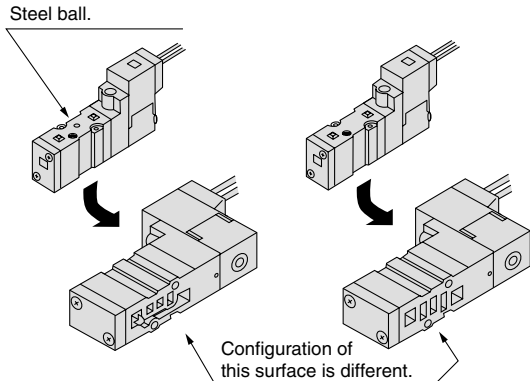

Bracket Mounting

① Insert the lower hook of the mounting bracket into the groove on the bottom of the valve as shown.

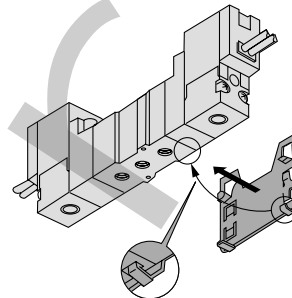

② Press the valve and mounting bracket together until the upper hook of the bracket snaps into place in the groove on top of the valve.

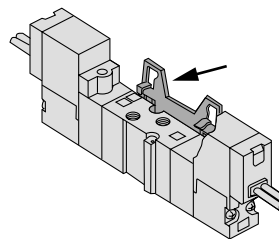

Mixed Installation of the SYJ300 and SYJ3000 Series Valves on the Same Manifold.

The SYJ300 series valves can be mounted on the manifolds for the SYJ3000 series.

① **Type SS5YJ3-20, SS5YJ3-21P**

The 3 way valve can be used on the 4 way manifold by simply sealing off the unused "R" port with plug VJ3000-33-1.

Applicable solenoid valve : Type SYJ312, Type SYJ312M
Type SYJ322, Type SYJ322M

② **Type SS5YJ3-31,-S31, SS5YJ3-32,-S32, SS5YJ3-46,-S46, SS5YJ3-32P**

The 3 way valve can be used on the 4 way manifold without modification. The A port of the valve will flow out of the B port of the manifold.

Applicable solenoid valve : Type SYJ314, Type SYJ314M
Type SYJ324, Type SYJ324M

③ **Type SS5YJ3-41,-S41**

The 3 way valve can be used on the 4 way manifold by simply sealing off the unused "R" port with plug VJ3000-33-1. The A port of the valve will flow out of the B port of the manifold.

Applied solenoid valve : Type SYJ314, Type SYJ314M
Type SYJ324, Type SYJ324M

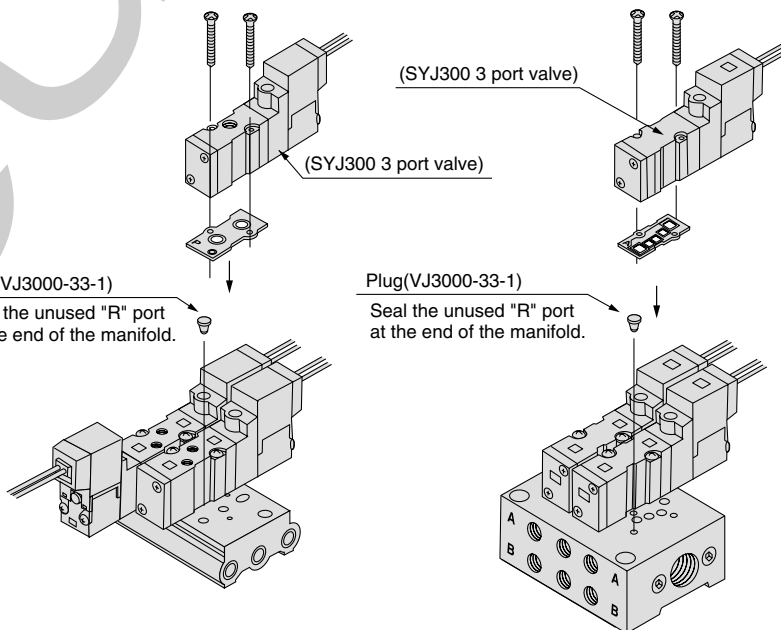

SS5YJ3-20

SS5YJ3-41

A port of the 3 way valve flows out the manifold B port.